



**ZUORDNUNGSLISTE NUTZFAHRZEUGE**  
**APPLICATION GUIDE COMMERCIAL VEHICLES**  
**TRUCK POWER**



**Edition 1 / 2014**



<b>OPTIBELT</b> .....	2-15
MARATHON 2 M=S   KBX   RBK   KIT .....	
<b>SERVICE TOOLS</b> .....	14-17
<b>TECDOC   VERKAUFSFÖRDERUNG</b> .....	18-21
SALES PROMOTION   PROMOTION DES VENTES   PROMOCIÓN DE VENTAS	
<b>MONTAGE- UND WARTUNGSHINWEISE</b> .....	22-23
INSTALLATION AND MAINTENANCE HINTS   CONSEILS DE MONTAGE ET D'ENTRETIEN	
MONTAJE E INSTRUCCIONES DE MANTENIMIENTO	
<b>HAFTUNG</b> .....	24
LIABILITY   RESPONSABILITÉ   RESPONSABILIDAD	
<b>ZEICHENERKLÄRUNG</b> .....	25
KEY TO SYMBOLS   SIGNIFICATION DES SYMBOLES   SIGNIFICADO DE SÍMBOLOS	
<b>ANWENDUNGSBEISPIEL</b> .....	25
APPLICATION EXAMPLES   EXEMPLES D'UTILISATION   EJEMPLO DE APLICACIÓN	
<b>TRANSPORTER</b> .....	27-217
TRANSPORTER   FOURGON   FURGONETA	
Citroën .....	28- 43
Daihatsu .....	43- 43
Fiat .....	43- 58
Ford .....	58- 74
Ford Australia .....	74- 81
Holden .....	81- 83
Hyundai .....	83- 87
Isuzu .....	87- 88
Iveco .....	88- 98
KIA .....	98- 98
LDV .....	98- 98
Mazda .....	99- 99
Mercedes-Benz .....	99-130
Mitsubishi .....	130-133
Nissan .....	133-136
Opel .....	136-141
Peugeot .....	141-159
Renault .....	159-168
Renault Trucks .....	168-170
Ssangyong .....	170-170
Subaru .....	170-170
Suzuki .....	170-170
Toyota .....	171-173
Vauxhall .....	173-177
VW .....	178-217
<b>LKW</b> .....	219-436
TRUCKS   POIDS LOURDS   CAMIONES	
DAF .....	220-229
Iveco .....	229-245
MAN .....	245-287
Mercedes-Benz .....	287-399
Mitsubishi .....	399-399
Multicar .....	399-399
Neoplan .....	399-399
Renault Trucks .....	400-422
Scania .....	422-431
Volvo .....	431-436
<b>TEILENUMMERN</b> .....	437-539
PART NUMBERS   RÉFÉRENCES   REFERENCIA ORIGINAL	
<b>OPTIBELT KIT</b> .....	540
REPAIR KITS	
<b>ABKÜRZUNGEN</b> .....	COVER
ABBREVIATIONS   ABRÉVIATIONS   ABREVIATURAS	

# OPTIBELT TR

„Keine Kompromisse.  
Ich bin mit OPTIBELT  
auf Achse.“

Jens, 41, Berufskraftfahrer



## ZUVERLÄSSIGKEIT AUF HÖCHSTEM NIVEAU

Es gibt wohl kaum einen Bereich, der auf die Sicherheit und Zuverlässigkeit von Motoren mehr angewiesen ist als der Güter- und Fernverkehr. Das Auswechseln eines billigen Bauteils und die entstehenden Ausfallzeiten kosten Unsummen, ganz besonders dann, wenn ein Unternehmen unter Just-in-time-Bedingungen fährt. Profiwerkstätten, die für die Wartung solcher Fuhrparks verantwortlich sind, setzen aus diesem Grund auf Erstausrüsterqualität und Präzision von OPTIBELT.





# TRUCK POWER

Keilriemen  
**optibelt MARATHON 2 M=S**

Keilrippenriemen  
**optibelt RBK**

Kraftband  
**optibelt KBX**

Reparaturatz  
**optibelt KIT**



# OPTIBELT TR

“No compromises.  
With OPTIBELT,  
I’m on the move.”

Jens, 41, professional driver



## THE HIGHEST LEVEL OF RELIABILITY

There is hardly any other field that is more reliant on engine safety and reliability than the freight and long distance transport industry. Replacing cheap components and the resulting downtimes cost enormous amounts, especially when a company is operating under the conditions of Just-In-Time production. It is for this reason that professional repair shops responsible for the maintenance of such fleets rely on the OE quality and precision that OPTIBELT offers.



# TRUCK POWER

V-belts  
**optibelt MARATHON 2 M=S**

Ribbed V-belts  
**optibelt RBK**

Kraftbands  
**optibelt KBX**

Repair kit  
**optibelt KIT**



# optibelt TRUCK POWER MARATHON 2 M=S

## KEILRIEMEN

## FLANKENOFFEN, FORMGEZAHNT



Der **optibelt MARATHON 2 M=S** wurde zielgerichtet für den Antrieb von Nebenaggregaten in NKW und Bussen entwickelt.

Der präzisionsgeschliffene Keilriemen kann durch seine engen Fertigungstoleranzen auch bei mehrilligen Antrieben ungemessen im Satz verwendet werden, erkennbar durch den Zusatz M=S (matched sets). Die Eigenschaft der Längengleichheit vereinfacht das Handling, vermeidet eine doppelte Lagerhaltung und ermöglicht eine besonders hohe Laufruhe – speziell bei mehrilligen Antrieben.

Außerdem ist der **MARATHON 2 M=S** besonders dehnungsarm und extrem verschleißfest, seine Lebensdauer ist um 40 bis 60% höher als die eines Standardriemens. Dies ermöglicht einen wirtschaftlichen und sicheren Betrieb der LKW und Busse.

### PROFILE

AVX 10; AVX 13; AVP 13

### PRODUKTVORTEILE

- Ungemessen satzverwendbar
- Verstärkter Aufbau
- Hohe Betriebssicherheit
- Wartungsarmer Betrieb und planbare Wartungsintervalle
- Hohe Abriebfestigkeit

### MARATHON 2 M=S im Querschnitt

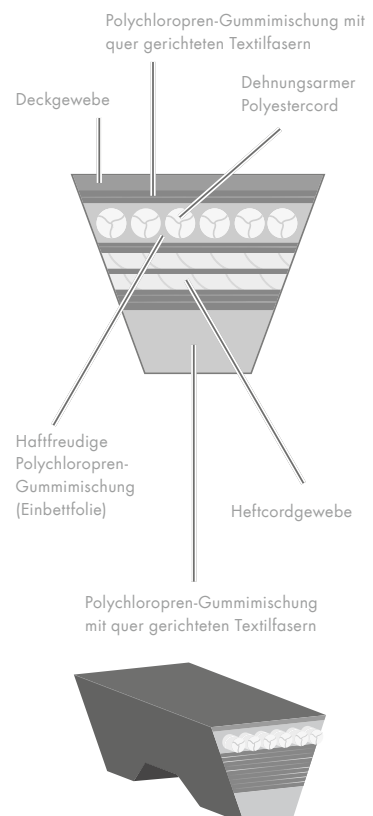



# optibelt TRUCK POWER MARATHON 2 M=S

## V-BELTS

### RAW EDGE, MOULDED COGGED



The **optibelt MARATHON 2 M=S** was especially developed for driving ancillary components in commercial vehicles and buses.

In the case of multi-groove drives, due to its manufacturing tolerances, the precision ground V-belt can even be used unmeasured in the set. This can be identified by the additional specification M=S (matched sets). The characteristic of being the same in length makes handling simpler, prevents double inventory and enables extremely smooth running – especially in the case of multi-groove drives.

Furthermore, the **MARATHON 2 M=S** is especially low stretch and extremely durable. Its durability is around 40–60% higher than that of a standard belt. This enables cost-effective and safe operation of the lorries and buses.

#### PROFILES

AVX 10; AVX 13; AVP 13

#### PRODUCT BENEFITS

- Installed without measuring
- Reinforced construction
- High level of operational safety
- Low-maintenance operation and predictable maintenance intervals
- High abrasion resistance

#### MARATHON 2 M=S cross section

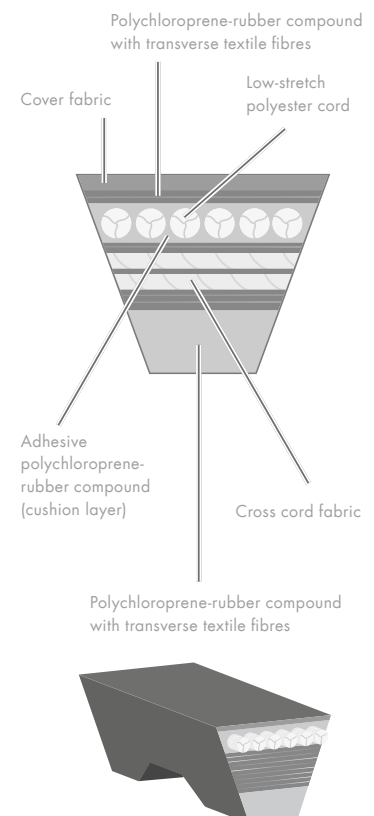

# optibelt TRUCK POWER KBX

## KRAFTBÄNDER FLANKENOFFEN, FORMGEZAHNT

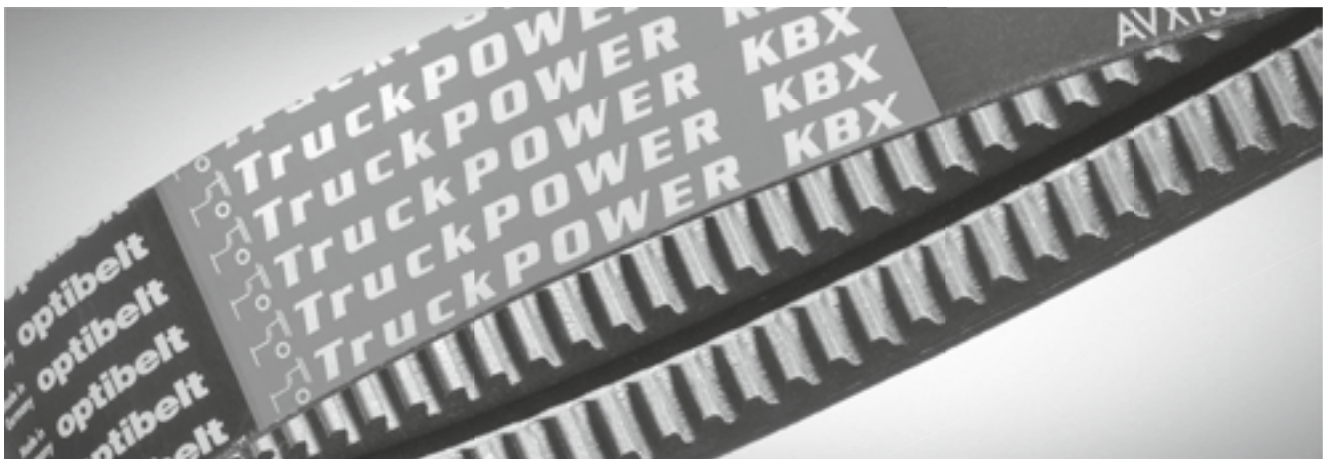

Die **optibelt KBX** Kraftbänder eignen sich besonders gut für kritische Antriebe in Nutzfahrzeugen und Bussen. Durch die kompakte Bauweise können Schwingungen bei langen Achsabständen stark reduziert werden. Mit ihrer rissbeständigen, quersteifen Deckplatte und dem präzisionsgeschliffenen Riemenunterbau dienen **KBX** vielen Fahrzeugherstellern als Problemlöser hochbelasteter Antriebe mit Luftpressern, Klimakompressoren und Lüftern.

### PROFILE

AVX 10 – 2 Rippen  
AVX 13 – 2 Rippen  
XPB – 2 Rippen

### PRODUKTVORTEILE

- Wartungsarmer Betrieb
- Hohe Laufruhe
- Kein Verdrehen der Riemen
- Schwingungsarm
- Hohe Abriebbeständigkeit

### KBX im Querschnitt

Deckplatte aus verschleißfester Polychloropren-Gummimischung

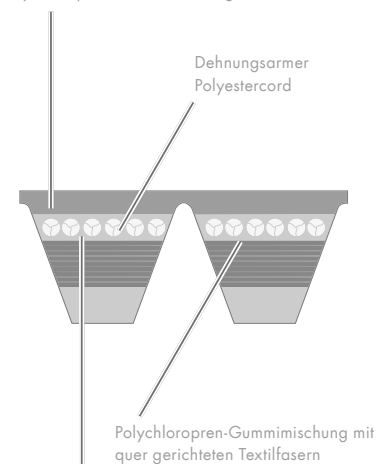

Haftfreudige Polychloropren-Gummimischung (Einbettfolie)

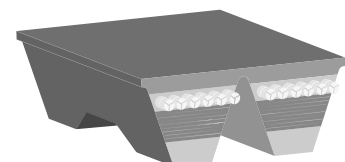

# optibelt TRUCK POWER KBX

## KRAFTBANDS

## RAW EDGE, MOULDED COGGED

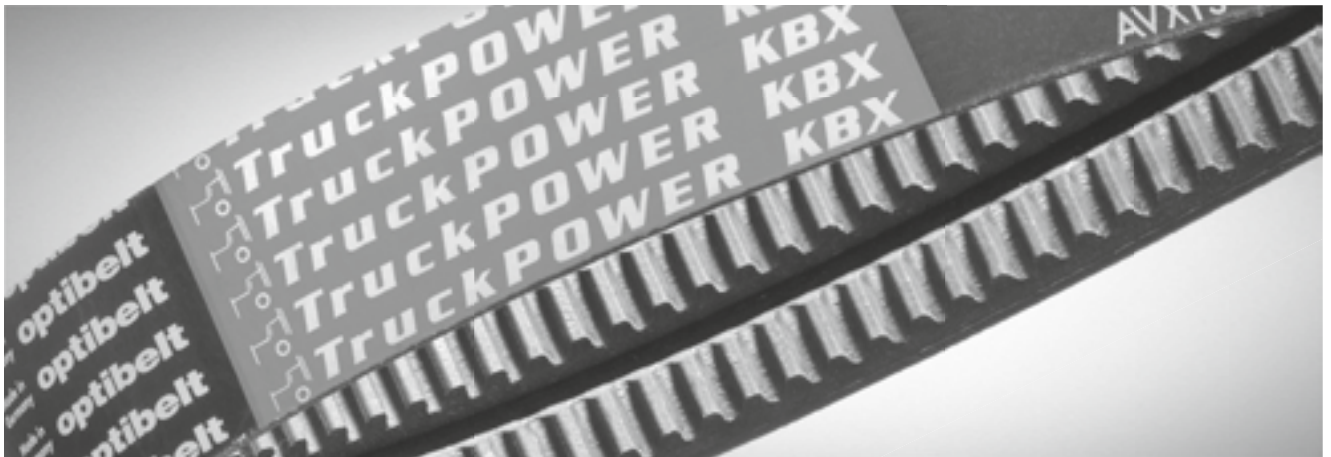

The **optibelt KBX** kraftbands are especially well suited for critical drive systems in commercial vehicles and buses. By means of their compact construction, vibrations of extended wheelbases can be considerably reduced. With tear resistant, transversely rigid top surface and precision-milled substructure, **KBX** kraftbands serve many vehicle manufacturers as a troubleshooter on high stress drives in air compressors, air conditioning units and ventilator fans.

### PROFILES

AVX 10 – 2 ribs

AVX 13 – 2 ribs

XPB – 2 ribs

### PRODUCT BENEFITS

- Low-maintenance operation
- Very smooth running
- No twisting in the belts
- Low level of vibration
- High abrasion resistance

### KBX cross section

Top surface made from durable polychloroprene-rubber compound

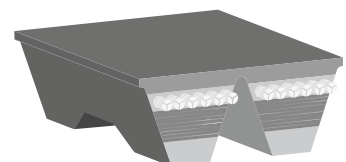
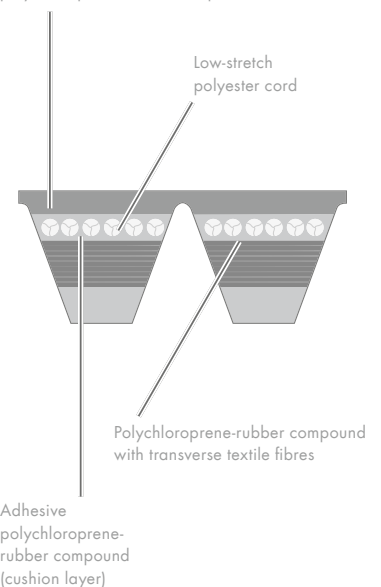

# optibelt TRUCK POWER RBK

## KEILRIPPENRIEMEN

## KEILRIPPENRIEMEN, ELASTISCH



Der **optibelt RBK** ist ein Hochleistungs-Keilrippenriemen für alle modernen Nebenaggregatsantriebe in Nutzfahrzeugen und Bussen.

Durch die hohe Biegewilligkeit erlaubt diese Riemenkonstruktion eine platzsparende Anordnung der Nebenaggregate in den immer enger werdenden Bauräumen heutiger Nutzfahrzeuge und Busse. Mit dem Einsatz elastischer Keilrippenriemen kann sogar auf zusätzliche Spannsysteme verzichtet werden. Diese Lösung unterstützt das Streben der Automobilindustrie nach Flexibilität, Leichtbau und Kostenoptimierung.

Selbst unter Umwelteinflüssen wie Staub, Nässe und extremen Temperaturen sorgt der **RBK** für eine sichere und geräuscharme Kraftübertragung. Ob im Zusammenspiel mit modernen Spannsystemen oder als elastischer Keilrippenriemen: Der **RBK** erfüllt die Vorgaben der Fahrzeughersteller und erzielt höchste Laufleistungen.

### PROFIL

PK

### PRODUKTVORTEILE

- Große Übersetzungsverhältnisse
- Hohe Kraftübertragung
- Minimaler Schlupf
- Hohe Temperaturbeständigkeit
- Schwingungs- und geräuscharm
- Nassschlupfoptimiert

### RBK im Querschnitt

Deckplatte: verschleißfeste Polychloropren-Gummimischung

Zugstrang: dehnungsarmer Polyester cord

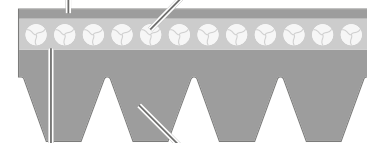

Kern: Polychloropren-Gummimischung

Einbettung: haftfreudige Polychloropren-Gummimischung (Einbettfolie)

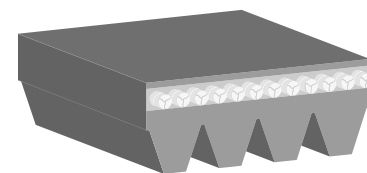



# optibelt TRUCK POWER RBK

## RIBBED V-BELTS

## RIBBED V-BELTS, ELASTIC



The **optibelt RBK** is a high performance ribbed V-belt for all modern standard ancillary component drives in commercial vehicles and buses.

By means of its high level of flexibility, this belt construction enables space to be saved when configuring ancillary components, an ever-increasing constraint in the commercial vehicles and buses of today. Tensioning systems can even be done without using additional elastic ribbed V-belts. This solution supports the automotive industry in its endeavours to achieve flexibility, light construction, and cost optimisation.

Even under environmental influences such as dust, moisture and extreme temperatures, the **RBK** provides for secure and silent power transmission. Whether combined with modern tensioning systems or as an elastic ribbed V-belt: the **RBK** satisfies vehicle manufacturer requirements and achieves the highest level of operational performance.

### PROFILE

PK

### PRODUCT BENEFITS

- High transmission ratio
- High power transmission
- Minimum slip
- High resistance to temperature
- Low levels of noise and vibrations
- Optimised wet slip resistance

### RBK cross section

Top surface: durable polychloroprene-rubber compound

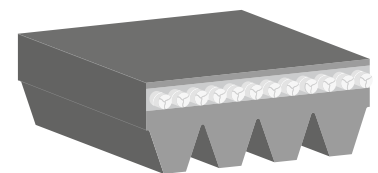
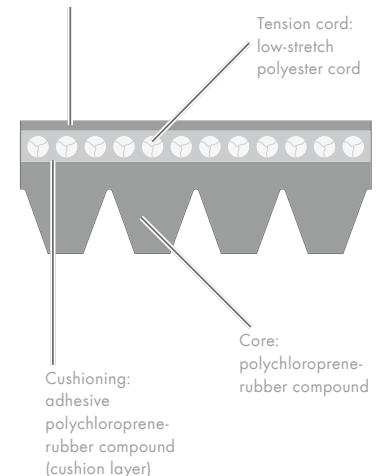

# optibelt KIT REPARATURSÄTZE

## ZUVERLÄSSIGKEIT AUF HÖCHSTEM NIVEAU

Ganz gleich, ob Personen oder Güter befördert werden:

Im Transportgeschäft herrscht ein harter Wettbewerb. Umso wichtiger ist es, teure und zeitraubende Ausfälle von Fahrzeugen zu vermeiden. OPTIBELT bietet deshalb einen kompletten und besonders montagefreundlichen Reparatursatz. Das **optibelt KIT** für NKW besteht aus einem Keilrippenriemen mit zugehöriger Spann- und Umlenkrolle.

Alle Bestandteile sind perfekt aufeinander abgestimmt. Wir empfehlen, sie immer vollständig auszutauschen. Bei regelmäßiger Kontrolle kann so ein Ausfall aufgrund einer falschen Vorspannung durch defekte Spannrollen nahezu ausgeschlossen werden. Gerne senden wir Ihnen auf Wunsch die **KIT-Zuordnungsliste** oder unseren Prospekt **Montage und Wartung** mit genaueren Angaben zu den Reparatursätzen und ihrer Handhabung zu.



**ALLE  
VORTEILE  
AUF EINEN  
BLICK!**

alle Teile in  
einem Reparatursatz

in bewährter  
Erstausrüsterqualität

funktionelle Verpackung

für alle gängigen  
NKW und Busse

# optibelt KIT REPAIR SETS

## THE HIGHEST LEVEL OF RELIABILITY

Whether people or goods are being conveyed:

In the transport business, there is really strong competition. That makes it even more important to avoid expensive and time-consuming vehicle failure. Therefore, OPTIBELT offers complete repair sets that are especially assembly-friendly. An **optibelt KIT** for commercial vehicles comprises a ribbed V-belt with corresponding tension and guide idler pulleys.

All components are perfectly aligned to one another. We always recommend to change them completely. If regularly checked, such failures due to wrong tension caused by defect tension pulleys can be almost completely excluded. Upon request, we would be happy to send you the **KIT** cross-over list or our brochure **Assembly and Maintenance** with more details on the repair sets and how to use them.



## ALL ADVANTAGES AT A GLANCE!

all parts included  
in a single repair set

in tried and tested  
OE quality

functional packaging

for all conventional  
commercial vehicles  
and buses

# SERVICE TOOLS



## **optibelt OPTIKRIK 0, I, II, III** für die Messung der Vorspannung von Keilriemen, Kraftband und Keilrippenriemen

Vorspannungsmessgeräte prüfen zuverlässig, ob der Keilriemen, das Kraftband oder der Keilrippenriemen in Ihrem Kraftfahrzeug richtig laufen. Die Handhabung der Messgeräte ist einfach. Unsere Außendienstmitarbeiter unterweisen Sie gern.



## **optibelt MESSLATTE** für die Messung von Innenlängen bei Keilriemen, Zahnriemen und Keilrippenriemen

Die **optibelt MESSLATTE** ist das perfekte Hilfsmittel zur Messung von Innenlängen. Der mögliche Messbereich liegt zwischen 500 und 2500 mm.

Bitte beachten: Alle ermittelten Innenlängen sind nur Anhaltswerte! Exakte Längenbestimmungen sind nach DIN-/ISO-/RMA-Norm durchzuführen.



## **optibelt LASER POINTER II** für die präzise Ausrichtung des Antriebs

OPTIBELT empfiehlt den handlichen **optibelt LASER POINTER II** zum Ausrichten des Antriebs. Das Ausrichten wird erleichtert, da kein Richtfaden gehalten werden muss und der kräftige, helle Laserstrahl klar auf dem silbernen Zielmagneten sichtbar wird.

Der Monteur kann schneller und genauer ausrichten. Weniger Reibung heißt weniger Scheiben- und Riemenverschleiß, längere Laufzeiten und damit weniger Standzeiten. Die Ersatzteilkosten sinken. Bei mehreren oder großen Antrieben amortisiert sich daher der Einsatz des **LASER POINTER II** meist schon im ersten Monat der Anschaffung.





# SERVICE TOOLS



**optibelt  
OPTIKRIK 0, I, II, III**  
for measuring the tension  
of V-belts, kraftbands,  
and ribbed V-belts

Regularly use the tension gauge to check if the V-belt, the kraftband or the ribbed V-belt is running properly in your vehicle. Handling the measuring gauges is simple. Our field service team will be happy to assist you.



**optibelt  
MEASURING GAUGE**  
for measuring inner lengths  
of V-belts, timing belts,  
and ribbed V-belts

The **optibelt MEASURING GAUGE** is the perfect aid for measuring inner lengths. It is possible to measure lengths between 500 and 2500 mm.

Please note: All inner lengths determined are only reference values! Determination of exact lengths must be carried out according to DIN / ISO / RMA standard.



**optibelt LASER POINTER II**  
for the precise alignment  
of the drive

OPTIBELT recommends the handy **optibelt LASER POINTER II** for aligning drives. Alignment is easier because it is not necessary to hold a levelling cord and the powerful and bright laser beam is visible on the silver target magnets.

The assembly engineer can perform alignment quicker and more accurately. Less friction means less wear on pulleys and belts, longer running time, thus resulting in fewer downtimes. Reduction in spare parts costs. In the case of several or large drives therefore, use of the **LASER POINTER II** pays off already in the first month of purchase.



# optibelt MT-A & MT-A II

**für den sicheren und fachgerechten Einbau elastischer optibelt EPK Keilrippenriemen**

Mit dem **optibelt MT-A** bekommen Sie ein universelles Werkzeug an die Hand, welches eine Vielzahl von teuren Spezialwerkzeugen der Fahrzeughersteller ersetzt. Die Riemen können schnell und fachgerecht montiert werden. Alles, was außerdem benötigt wird, sind der **EPK** Riemen und ein Schrauben- oder Steckschlüssel, um die Antriebsscheibe manuell drehen zu können.

Durch die spezielle Funktionsweise des Werkzeuges kann eine Vielzahl von Fahrzeugen gewartet werden. Es ist für einen langfristigen Gebrauch konzipiert. Die Anschaffung wird jeder Werkstatt empfohlen, die für die neue Riemen- generation und deren spezielle Montage gerüstet sein möchte und muss.



**QR-CODE SCANNEN – FILM AB!  
DER OPTIBELT MT-A & MT-A II  
IM EINSATZ**



#### PRODUKTVORTEILE

- Einfache Handhabung
- Zusätzliches Hilfsmittel zur Demontage des alten Riemens
- Verhindert Überdehnung oder Beschädigung des Riemens

# optibelt TT-A

**für die schnelle und exakte Ermittlung der korrekten Antriebsriemenspannung**

Das neue **optibelt TT-A** Frequenz-Messgerät ermöglicht es Kfz-Werkstätten, exakt, schnell und unkompliziert die korrekte Spannung zu ermitteln und zu kontrollieren. So sind Sie bei der Wartung und beim Austausch von Antriebsriemen immer auf der sicheren Seite. Die Arbeitsweise des Gerätes ist simpel: Nach dem Einschalten ist das Gerät sofort zur Messung bereit. Der vorgespannte Riemen wird durch Anschlagen per Finger oder mit einem Gegenstand in Schwingung versetzt. Die daraus resultierenden Riemenschwingungen werden mit dem Messfühler erfasst.

Der Messwert wird auf dem Display des Gerätes in der Einheit Hertz angezeigt. Die erforderlichen Einstellwerte für eine Vielzahl von Fahrzeugen lassen sich ganz einfach aus dem mitgelieferten Handbuch ermitteln. Diese Art der Messung hat sich bei OPTIBELT seit Jahren bewährt und spiegelt den aktuellen Stand der Technik wider. Das **TT-A** misst die Spannung von **RBK** und **ZRK** Riemen sowie aller OE- und OE-identischen Zahnriemen und Keilrippenriemen.



#### PRODUKTVORTEILE

- Einfache 1-Knopf-Bedienung
- Kompakter Messfühler, auch für enge Motorräume und schwer zugängliche Stellen
- Gut lesbare LCD-Anzeige
- Auto-Abschaltung nach 3 Min.
- Akustisches Messsignal

# optibelt MT-A & MT-A II

for safe and proper installation of elastic  
optibelt EPK V-ribbed belts

With the **optibelt MT-A** you have a universal tool at your disposal that can replace many expensive special tools used by automobile manufacturers. The belts can therefore be installed properly and quickly. The **EPK** belt and a screw driver or socket spanner are the only things that are additionally needed to manually turn the driving pulley.

Maintenance can be performed on several vehicles due to this special functionality of the tool. It is designed for use of the long term. Its purchase is recommended to every workshop that would like to be, and must be equipped for the new generation of belts and their special type of assembly.



SCAN A QR CODE – SHOWTIME!  
THE OPTIBELT MT-A & MT-A II IN USE



## PRODUCT BENEFITS

- Easy handling
- Additional aid for disassembly of old belts
- Prevents twisting or damage to belts

# optibelt TT-A

for quick and exact determination  
of correct drive belt tension

The new **optibelt TT-A** frequency tension tester makes it possible for commercial vehicle repair shops to determine and regulate the correct tension quickly and in an uncomplicated manner. In this way, during maintenance and the replacement of drive belts, you are always on the safe side. Using the device is simple: After start up, the device is immediately ready for measuring. The pretensioned belt is caused to vibrate by plucking it with a finger or another object. The resulting belt vibrations are detected by the detecting element.

The measured value is indicated in Hertz on the display of the device. The required configuration values for multiple vehicles can be determined simply by checking the supplied manual. This type of measurement has stood the test of time for years at OPTIBELT and reflects the current state of the art. The **TT-A** measures the tension of **RBK** and **ZRK** belts as well as OE and OE-identical timing belts and ribbed V-belts.



## PRODUCT BENEFITS

- Simple 1-button operation
- Compact detecting element, even in the case of narrow engine compartments and areas that are difficult to access
- Well readable LCD display
- Automatic shut-down after 3 min.
- Acoustical measuring signal

# AUF HOCHTOUREN

**Für unsere Vertriebspartner geben wir Vollgas:  
Ob Einkauf oder Verkauf – mit verschiedenen  
Maßnahmen und Services sorgt OPTIBELT dafür,  
dass die Geschäfte noch besser laufen.**

## TECDOC

**HÖCHSTE PRÄZISION BEI DER DATENÜBERMITTLUNG –  
OPTIBELT IST „TECDOC CERTIFIED DATA SUPPLIER“.**



TecDoc versorgt Werkstätten und Handel mit aktuellen und umfassenden Daten zur Identifizierung und Bestellung von Teilen – sowohl im PKW- als auch im NKW-Bereich. Bereitgestellt werden die Informationen direkt aus den Datenbanken der kooperierenden Automobilteile-Hersteller in standardisierter Katalogform. Als besonders zuverlässiger TecDoc-Partner, der die hierfür notwendigen Qualitätskriterien in jeder Hinsicht erfüllt, bekam OPTIBELT das Gütesiegel „TecDoc Certified Data Supplier“ verliehen.

## PARTSLIFE

**FÜR OPTIBELT IST UMWELTSCHUTZ MEHR ALS  
DIE EINHALTUNG GESETZLICHER RICHTLINIEN.**



Die Frage ist: Wie lassen sich ökologische, wirtschaftliche und soziale Verantwortung auf einen Nenner bringen? Mit dem auf die Kfz-Teilebranche spezialisierten Umweltmanagement-System Partslife steht OPTIBELT ein verlässliches System in Sachen Umweltschutz zur Seite.







„Rund um die Uhr  
für mich da.“

Michael, 33, Mechatronikmeister



**MEDIA PLUS**

Unser B2B-Shop im Netz:  
Alle Produkte rund um die  
Uhr online bestellen.



**NEWSLETTER**

Bleiben Sie auf dem Laufenden und  
registrieren Sie sich jetzt für die  
Automotive-E-Mail-News unter  
[www.optibelt.com/automotivenews](http://www.optibelt.com/automotivenews)



**OPTIBELT CONNECT**

Die direkte Verbindung zu Ihrer  
Warenwirtschaft bietet Planungs-  
sicherheit und Kostenersparnis.



**TECDOC**

Edition 1/2014

# AT FULL BLAST

**For our distribution partners, we are giving all we've got: Whether purchasing or sales – with various measures of action and services OPTIBELT ensures that business runs better.**

## TECDOC

**THE HIGHEST LEVEL OF PRECISION WHEN TRANSFERRING DATA – OPTIBELT IS A "TECDOC CERTIFIED DATA SUPPLIER".**



TecDoc provides repair shops and business with current and comprehensive data for the identification and ordering of parts – for the passenger cars industry as well as the industry for commercial vehicles. The information is made available directly from the data bases of cooperating automotive component manufacturers in standardised catalogue format. As a reliable TecDoc partner that meets the related quality criteria required in every aspect, OPTIBELT was awarded the quality label "TecDoc Certified Data Supplier".

## PARTSLIFE

**ENVIRONMENTAL PROTECTION MEANS MORE TO OPTIBELT THAN JUST COMPLYING WITH LEGAL REQUIREMENTS.**



The question is: How can we reduce ecological, economic and social responsibility down to a common denominator? With the environmental management system, Partslife, which is specialised for the motor vehicle industry, OPTIBELT has a reliable system with regard to environmental protection at its side.

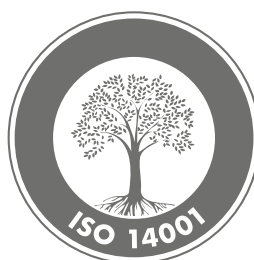



“Here for me,  
around the clock.”

Michael, 33, mechatronics technician



**MEDIA PLUS**

Our B2B shop in the Internet:  
Order all products around the  
clock online.



**NEWSLETTER**

Keep up-to-date and register now  
for Automotive E-mail News at  
[www.optibelt.com/automotivenews](http://www.optibelt.com/automotivenews)



**OPTIBELT CONNECT**

Planning safety and cost savings  
offer a direct connection to your  
enterprise resource planning.



**TECDOC**

Edition 1/2014

# MONTAGE- UND WARTUNGSHINWEISE

## INSTALLATION AND MAINTENANCE HINTS

### CONSEILS DE MONTAGE ET D'ENTRETIEN

### MONTAJE E INSTRUCCIONES DE MANTENIMIENTO

#### MONTAGE- UND WARTUNGSHINWEISE

OPTIBELT-Kfz-Antriebselemente gewährleisten hohe Betriebssicherheit und optimale Lebensdauer, wenn folgende Hinweise beachtet werden:

1. Die Riemenscheiben müssen genau fluchtend angeordnet sein.
2. Vor der Montage ist der Achsabstand so zu verringern, dass die Riemen zwanglos aufgelegt werden können.
3. Anschließend sind die Antriebselemente nach folgender Empfehlung zu spannen:

Profil	OPTIBELT-Ausführung	Erstspannung	Nachspannung auf Trunkraft*
AVX 10	MARATHON 1/ MARATHON 2 M=S	450 +/- 50 N	300 +/- 50 N
AVX 13	MARATHON 1/ MARATHON 2 M=S	550 +/- 50 N	400 +/- 50 N

Die Vorspannung sollte mit dem OPTIKRIK Vorspannungsmessgerät I bzw. II durchgeführt werden.

4. Keilriemen für mehrrillige Antriebe müssen üblicherweise zu Sätzen vermessen werden. OPTIBELT-Keilriemen mit der Kennzeichnung „M=S“ sind uneingeschränkt satzverwendbar, so dass eine Satzvermessung nicht notwendig ist.
5. Zahnflachriemen sind nach den Einbauvorschriften der Kfz-Hersteller zu montieren.

\* Bei erneuter Montage oder aus Gründen, die nicht in unserem Einflussbereich liegen, ist wie oben beschrieben zu spannen.

#### INSTALLATION AND MAINTENANCE HINTS

OPTIBELT automotive drive elements guarantee operating safety and optimum belt life provided the following advice is followed:

1. The pulleys should be correctly aligned.
2. Before assembly the drive centre distance is to be reduced so that the belts can be fitted without undue force.
3. Subsequently the drive elements are to be tensioned in accordance with the following recommendations:

Section	OPTIBELT construction	Initial tensioning	Re-tensioning*
AVX 10	MARATHON 1/ MARATHON 2 M=S	450 +/- 50 N	300 +/- 50 N
AVX 13	MARATHON 1/ MARATHON 2 M=S	550 +/- 50 N	400 +/- 50 N

The initial tensioning should be carried out with the OPTIKRIK tension tester type I or II.

4. Fan Belts for drives with multiple grooves should normally be supplied in sets. OPTIBELT fan belts with the designation "M=S" can be used in sets without further measurement.
5. Timing belts are to be fitted in accordance with the car manufacturer's instructions.

\* In case of a re-installation or for reasons beyond our control, please tension as described above.



# MONTAGE- UND WARTUNGSHINWEISE

## INSTALLATION AND MAINTENANCE HINTS

### CONSEILS DE MONTAGE ET D'ENTRETIEN

### MONTAJE E INSTRUCCIONES DE MANTENIMIENTO

#### CONSEILS DE MONTAGE ET D'ENTRETIEN

Les courroies automobiles OPTIBELT apportent une grande sécurité de fonctionnement ainsi qu'une durée de vie optimale lorsque les conditions ci-dessous sont respectées:

- 1°) Les poulies doivent être correctement alignées.
- 2°) Avant le montage, l'entraxe doit être réduit de manière à ce que les courroies ne soient pas montées en force.
- 3°) Enfin, la tension des éléments de transmission doit être faite de la manière suivante:

Section	Exécution OPTIBELT	Première tension	Retension*
AVX 10	MARATHON 1/ MARATHON 2 M=S	450 +/- 50 N	300 +/- 50 N
AVX 13	MARATHON 1/ MARATHON 2 M=S	550 +/- 50 N	400 +/- 50 N

La tension doit être contrôlée avec l'appareil de tension OPTIKRIK I ou II.

- 4°) Les courroies montées en jeux doivent être préalablement mesurées. Ce n'est pas le cas des courroies OPTIBELT marquées M=S, de série constante, n'ayant pas besoin d'être mesurées pour former des jeux.
- 5°) Les courroies dentées de distribution sont à monter selon les prescriptions du constructeur.

\* En cas de repose ou pour des raisons ne nous concernant pas, la tension est à réaliser comme indiqué ci-dessus.

#### MONTAJE E INSTRUCCIONES DE MANTENIMIENTO

Los elementos de accionamiento OPTIBELT para la industria del automóvil garantizan elevada seguridad de funcionamiento y una optima duración de vida, si se tienen en cuenta las siguientes instrucciones:

1. Las poleas deben de estar exactamente alineadas.
2. Antes del montaje se reducirá la distancia entre centros, y a continuación se colocará la correa.
3. A continuación recomendamos los siguientes valores de tensado de los elementos de accionamiento:

Perfil	Ejecución OPTIBELT	1° tensado	Postensado*
AVX 10	MARATHON 1/ MARATHON 2 M=S	450 +/- 50 N	300 +/- 50 N
AVX 13	MARATHON 1/ MARATHON 2 M=S	550 +/- 50 N	400 +/- 50 N

El pretensado se deberá de realizar con el tensor I ó II de correas OPTIKRIK.

4. Las correas trapeziales en juegos para accionamientos con canales multiples se deberán medir previamente. Las correas OPTIBELT marcadas M=S se pueden utilizar en juegos ilimitadamente sin necesidad de medición previa.
5. Para montar las correas planas dentadas se tendrán en cuenta las instrucciones de los fabricantes de vehículos.

\* Para nuevos montajes u otros motivos que no se encuentren en nuestro sector de influencia, es el tensado tal como se describe arriba.

**D**

Die in dieser Vergleichsliste gemachten Angaben basieren auf sorgfältigen Untersuchungen.

Änderungen sind jedoch durch den Verfasser nicht auszuschließen, so dass der Anwender nicht davon entbunden ist, sich von der Richtigkeit der Angaben zu überzeugen.

Der Verfasser schließt im Rahmen gesetzlicher Vorschriften und seiner Geschäftsbedingungen Garantie und Haftung für die in diesem Druckwerk gemachten Angaben aus.

**DK**

De i denne folder givne oplysninger bygger på omhyggelige.

Ændringer kan dog ikke udelukkes, hvorfor brugeren har det endelige ansvar for at sikre sig, at de givne oplysninger er korrekte.

I overensstemmelse med nationale handelsbetingelser og egne salgsvilkår frasiger udgiver sig enhver garanti og hæftelse for rigtighed af oplysninger anført i denne folder.

**E**

Los datos contenidos en esta lista de comparación se basan en esmeradas investigaciones. Modificaciones, no obstante, no están excluidas por parte del autor. Por lo tanto, el usuario no está exento de verificar que los datos son correctos.

El autor excluye, en base a lo dispuesto por la ley y sus condiciones de venta, garantía y responsabilidad referente a lo indicado en esta documentación.

**F**

Les données figurant sur cette liste de comparaison sont le fruit de recherches approfondies.

Cependant, des modifications n'étant pas exclues, l'utilisateur doit vérifier l'exactitude de ces données.

Conformément à la législation et à nos conditions générales de vente, nous déclinons toute garantie ou responsabilité quant au contenu de ce document.

**FIN**

Tässä suositusluettelossa esitetyt tiedot perustuvat tarkkaan tutkimukseen. Vuosien varrella on tehty muutoksia joten suositellaan, että suositusluettelon käyttäjä varmistaa, että tässä esitetyt tiedot ovat oikeat. Tekijä ei vastaa tässä suositusluettelossa esitetyistä tiedoista.

**GB**

The information in this publication is based on experience, calculation, research and development and is correct to the best of our knowledge.

Changes in applications subsequent to the issue of the document can render it inaccurate in some instances.

The Arntz OPTIBELT Group accepts no liability or claims for direct, indirect, special, incidental or consequential damages arising from any use or misuse of this publication.

**GR**

Οι πληροφορίες που περιέχονται στον παρόντα κατάλογο βασίζονται σε δεδομένα επιμελών ερευνητών.

Διαφοροποιήσεις πάντως δεν είναι δυνατόν να αποκλειστούν, και για τον λόγο αυτό ο εφαρμοστής δεν απαλλάσσεται από την υποχρέωση να επιβεβαιώσει την ορθότητα των δεδομένων και των αποτελεσμάτων.

Για τις πληροφορίες που περιέχονται στο παρόν έντυπο ο συντάκτης τους αποκλείει κάθε είδους ευθύνη του για οποιασδήποτε φύσεως ζημιές που τυχόν προκληθούν από την χρήση τους.

**I**

Le indicazioni contenute in questa tabella comparativa si basano su accurate indagini e ricerche. Modifiche tecniche non possono però essere escluse da parte nostra, per cui chi ne fa uso non è sollevato dall'obbligo di verificare l'esattezza delle indicazioni.

L'autore esclude, nell'ambito delle disposizioni legali e delle condizioni commerciali, ogni garanzia e non si assume la responsabilità per le indicazioni contenute in questa documentazione.

**NL**

De gedane informatie in deze vergelijkingslijst is gebaseerd op zorgvuldig onderzoek.

Wijzigingen hierin zijn niet uit te sluiten en daarom dient de gebruiker omtrent de juistheid van deze informatie zich te overtuigen.

Onze algemene leveringsvoorwaarden sluiten aansprakelijkheid voor in dit drukwerk gedane informatie uit.

**S**

Uppgifterna i denna lista baserar sig på noggranna undersökningar. Ändringar under tiden kan inte uteslutas, varför användaren inte är bunden till uppgifterna. Författaren undantar inom ramen för lagliga bestämmelser och affärsvillkor all garanti och ansvar för de angivna uppgifterna i listan.

# ZEICHENERKLÄRUNG

## KEY TO SYMBOLS

### SIGNIFICATION DES SYMBOLES

### SIGNIFICADO DE SÍMBOLOS



Transporter  
Transporter  
Fourgon  
Furgoneta



LKW  
Trucks  
Poids lourds  
Camiones



Motor Code  
Engine code  
Code moteur  
Código motor



Kalender  
Calendar  
Calendrier  
Calendario

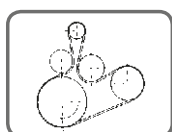

Anwendungen  
Application  
Utilisation  
Aplicación

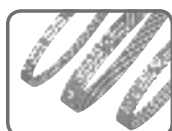

Abmessung  
Size  
Dimension  
Dimensión

# ANWENDUNGSBEISPIEL

## APPLICATION EXAMPLES

### EXEMPLES D'UTILISATION

### EJEMPLO DE APLICACIÓN



## DAF

45

### 45.120-035

5880 ccm	85 kW	CD 85	05.91 - 12.00	ALT	FROM: 12.93; MOD: FA45.120-06	<b>8 PK 1460 TM</b>
				ALT	UNTIL: 11.93; AMP: 55; MOD: FA45.120-06	<b>8 PK 1460 TM</b>
				ALT	UNTIL: 11.93; MOD: FA45.120-06; - AMP: 100	<b>8 PK 1400 TM</b>

### 45.120-06

5880 ccm	85 kW	CD 85	05.91 - 12.00	ALT	FROM: 12.93; MOD: FA45.120-06	<b>8 PK 1460 TM</b>
				ALT	UNTIL: 11.93; AMP: 55; MOD: FA45.120-06	<b>8 PK 1460 TM</b>
				ALT	UNTIL: 11.93; MOD: FA45.120-06; - AMP: 100	<b>8 PK 1400 TM</b>

### 45.130.B06; 45.130.C06

5880 ccm	97 kW	CS 97 M;CT 97	05.91 - 12.00	ALT	FROM: 12.93; MTR-CODE: CN96;CS97M;CT97	<b>8 PK 1460 TM</b>
				ALT	UNTIL: 11.93; MTR-CODE: CN96;CS97M;CT97; - AMP: 100	<b>8 PK 1400 TM</b>



**TRANSPORTER**  
TRANSPORTER  
FOURGON  
FURGONETA





## CITROËN

### JUMPY (U6U)

#### 1.6

1581 ccm	58 kW	1580 SPI;220 A2.000	10.95 -	PS		AVX 10 x 675
				AC-C	MTR-CODE: 220A2000	6 PK 925
				ALT	MTR-CODE: 220A2000; - AC	6 PK 894
				ALT	MTR-CODE: 220A2000; + AC	4 PK 905
				CAM		ZRK 1244
				CAM		KT 1037

#### 2.0

1997 ccm	100 kW	RFN (EW10J4)	04.00 -	ALT	- AC	6 PK 1190
				ALT	+ AC	6 PK 1710
				CAM		ZRK 1149
				CAM		KT 1244
				W-P; CAM	OPT	KT 1244 W3

#### 2.0 i 16V

1997 ccm	102 kW		03.00 -	ALT	FROM: 09.00; MTR-CODE: EW10J4; - AC	6 PK 1190
				ALT	FROM: 09.00; MTR-CODE: EW10J4; + AC	6 PK 1710
				CAM		ZRK 1149
				CAM	MTR-CODE: RFN	KT 1244
				W-P; CAM	OPT	KT 1244 W3

#### 1.9 D 70

1868 ccm	51 kW	WJZ (DW8)	04.98 -	ALT	FROM: 09.98; MTR-CODE: DW8;DW8;DW8B; - AC; - PS	6 PK 865
				ALT	FROM: 09.98; MTR-CODE: DW8;DW8;DW8B; + AC; - PS	6 PK 1038
				ALT	FROM: 09.98; MTR-CODE: DW8;DW8;DW8B; OE-NO.: 5750R5; + AC; + PS	6 PK 1735
				ALT	FROM: 09.98; MTR-CODE: DW8;DW8;DW8B; OE-NO.: 5750Z7; + AC; + PS	6 PK 1751
				ALT	FROM: 09.98; MTR-CODE: DW8;DW8B;DW8B; - AC	6 PK 1440
				ALT	FROM: 09.98; UNTIL: 10.99; MTR-CODE: DW8;DW8;DW8B; UNTIL ORGA-NO.: 8374; + PS; - AC	6 PK 1390
				ALT	FROM: 09.98; UNTIL: 12.02; MTR-CODE: DW8;DW8B;DW8B; UNTIL ORGA-NO.: 09519; + AC	6 PK 1735
				ALT	FROM: 10.99; MTR-CODE: DW8;DW8;DW8B; FROM ORGA-NO.: 08375; + PS; - AC	6 PK 1440
				ALT	FROM: 12.02; MTR-CODE: DW8;DW8B;DW8B; FROM ORGA-NO.: 09520; + AC	6 PK 1675
				CAM		ZRK 1351
				CAM		KT 1433
				W-P; CAM		KT 1517 W1

#### 1.9 D

1905 ccm	51 kW	D9B (XUD9A/U)	10.95 -	VAC-P		AVX 10 x 650
				ALT	- AC; - PS	6 PK 730
				ALT	+ AC; - PS	6 PK 1165
				ALT	+ AC; + PS	6 PK 1740
				ALT	+ PS; - AC	6 PK 1115
				CAM		ZRK 1262
				CAM		KT 1040
				W-P; CAM		KT 1040 W1

#### 1.9 TD

1905 ccm	66 kW	DHX (XUD9TF/BTF)	10.95 -	VAC-P		AVX 10 x 650
				ALT	- AC; - PS	6 PK 730
				ALT	+ AC; - PS	6 PK 1165
				ALT	+ AC; + PS	6 PK 1740
				ALT	+ PS; - AC	6 PK 1115
				CAM		ZRK 1262
				CAM		KT 1040
				W-P; CAM		KT 1040 W1

#### 1.9 TD

1905 ccm	68 kW	D8B (XUD9TF)	04.96 -	VAC-P		AVX 10 x 650
				ALT	- AC; - PS	6 PK 730
				ALT	+ AC; - PS	6 PK 1165
				ALT	+ AC; + PS	6 PK 1740
				ALT	+ PS; - AC	6 PK 1115
				CAM		ZRK 1262
				CAM		KT 1040

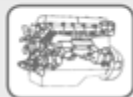

## CITROËN

### JUMPY (U6U)

#### 1.9 TD

1905 ccm 68 kW D8B (XUD9TF) 04.96 - W-P; CAM **KT 1040 W1**

#### 2.0 HDi 95

1997 ccm 69 kW RHX (DW10BTED) 10.99 - CAM MTR-CODE: DW10ATED4 **ZRK 1441**  
 CAM FROM ORGA-NO.: 10011; MTR-CODE: DW10ATED4 **KT 1480**  
 CAM MTR-CODE: DW10ATED4; UNTIL ORGA-NO.: 10010 **KT 1351**  
 W-P; CAM FROM ORGA-NO.: 09868 **KT 1327 W1**  
 W-P; CAM UNTIL ORGA-NO.: 09867 **KT 1518 W1**

#### 2.0 HDi 110

1997 ccm 80 kW RHZ (DW10ATED) 03.00 - ALT FROM: 12.03; MTR-CODE: DW10ATED;DW10CTED; + AC **6 PK 1740**  
 ALT FROM: 12.03; MTR-CODE: DW10CTED; - AC **6 PK 1470**  
 ALT FROM: 12.03; MTR-CODE: DW10CTED; + AC **6 PK 1740**  
 ALT MTR-CODE: DW10ATED;DW10CTED; - AC **6 PK 1470**  
 ALT UNTIL: 11.03; MTR-CODE: DW10ATED;DW10CTED; FOR: DELPHI; + AC **6 PK 1751**  
 ALT UNTIL: 11.03; MTR-CODE: DW10ATED;DW10CTED; FOR: SANDEN; + AC **6 PK 1740**  
 CAM MTR-CODE: DW10ATED;DW10BTED **ZRK 1352**  
 CAM MTR-CODE: DW10ATED4 **ZRK 1441**  
 CAM FROM ORGA-NO.: 08561 **KT 1518**  
 CAM MTR-CODE: DW10ATED;DW10BTEDW3; UNTIL ORGA-NO.: 08560 **KT 1327**  
 CAM MTR-CODE: DW10ATED4; FROM ORGA-NO.: 10011 **KT 1480**  
 CAM MTR-CODE: DW10ATED4; UNTIL ORGA-NO.: 10010 **KT 1351**  
 CAM MTR-CODE: DW10BTEDW4; UNTIL ORGA-NO.: 09867 **KT 1327**  
 CAM MTR-CODE: DW10CTED **KT 1534 W1**  
 W-P; CAM FROM ORGA-NO.: 08561 **KT 1518 W1**  
 W-P; CAM UNTIL ORGA-NO.: 08560 **KT 1327 W1**

#### 2.0 HDi 110

1997 ccm 80 kW RHW (DW10ATED4) 03.00 - W-P; CAM FROM ORGA-NO.: 10011 **KT 1480 W1**

### JUMPY Kasten (BS\_, BT\_, BY\_, BZ\_)

#### 1.6 i

1581 ccm 58 kW 1580 SPI;220 A2.000 10.95 - AC-C MTR-CODE: 220A2000 **6 PK 925**  
 ALT MTR-CODE: 220A2000; - AC **6 PK 894**  
 ALT MTR-CODE: 220A2000; + AC **4 PK 905**  
 CAM **ZRK 1244**  
 CAM **KT 1037**

#### 1.6

1581 ccm 59 kW 220 A2.000 10.95 - AC-C **6 PK 925**  
 ALT - AC **6 PK 894**  
 ALT + AC **4 PK 905**

#### 2.0 i 16V

1997 ccm 102 kW 03.00 - ALT FROM: 09.00; MTR-CODE: EW10J4; - AC **6 PK 1190**  
 ALT FROM: 09.00; MTR-CODE: EW10J4; + AC **6 PK 1710**  
 CAM **ZRK 1149**  
 CAM MTR-CODE: RFN **KT 1244**  
 W-P; CAM OPT **KT 1244 W3**

#### 1.9 D

1905 ccm 51 kW D9B (XUD9A/U) 10.95 - ALT - AC; - PS **6 PK 730**  
 ALT + AC; - PS **6 PK 1165**  
 ALT + AC; + PS **6 PK 1740**  
 ALT + PS; - AC **6 PK 1115**

#### 1.9 D 70

1868 ccm 51 kW WJZ (DW8) 04.98 - ALT FROM: 09.98; MTR-CODE: DW8;DW8;DW8B; - AC; - PS **6 PK 865**  
 ALT FROM: 09.98; MTR-CODE: DW8;DW8;DW8B; + AC; - PS **6 PK 1038**  
 ALT FROM: 09.98; MTR-CODE: DW8;DW8;DW8B; OE-NO.: 5750R5; + AC; + PS **6 PK 1735**  
 ALT FROM: 09.98; MTR-CODE: DW8;DW8;DW8B; OE-NO.: 5750Z7; + AC; + PS **6 PK 1751**  
 ALT FROM: 09.98; MTR-CODE: DW8;DW8B;DW8B; - AC **6 PK 1440**

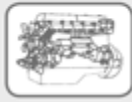

## CITROËN

### JUMPY Kasten (BS\_, BT\_, BY\_, BZ\_)

1.9 D 70						
1868 ccm	51 kW	WJZ (DW8)	04.98 -	ALT	FROM: 09.98; UNTIL: 10.99; MTR-CODE: DW8;DW8;DW8B; UNTIL ORGA-NO.: 8374; + PS; - AC	6 PK 1390
				ALT	FROM: 09.98; UNTIL: 12.02; MTR-CODE: DW8;DW8B;DW8B; UNTIL ORGA-NO.: 09519; + AC	6 PK 1735
				ALT	FROM: 10.99; MTR-CODE: DW8;DW8;DW8B; FROM ORGA-NO.: 08375; + PS; - AC	6 PK 1440
				ALT	FROM: 12.02; MTR-CODE: DW8;DW8B;DW8B; FROM ORGA-NO.: 09520; + AC	6 PK 1675
				CAM		ZRK 1351
				CAM		KT 1433
				W-P; CAM		KT 1517 W1

1.9 DT						
1905 ccm	65 kW		10.95 -	ALT	- AC; - PS	6 PK 730
				ALT	+ AC; - PS	6 PK 1165
				ALT	+ AC; + PS	6 PK 1740
				ALT	+ PS; - AC	6 PK 1115

1.9 TD						
1905 ccm	66 kW	DHX (XUD9TF/BTF)	10.95 -	ALT	MTR-CODE: XUD9TE; - AC; - PS	6 PK 730
				ALT	MTR-CODE: XUD9TE; + AC; - PS	6 PK 1165
				ALT	MTR-CODE: XUD9TE; + AC; + PS	6 PK 1740
				ALT	MTR-CODE: XUD9TE; + PS; - AC	6 PK 1115
				CAM		ZRK 1262
				CAM		KT 1040
				W-P; CAM		KT 1040 W1

2.0 HDi 95						
1997 ccm	69 kW	RHX (DW10BTED)	10.99 -	ALT	FROM: 02.00; MTR-CODE: DW10ATED;DW10BTED; - AC	6 PK 1470
				ALT	FROM: 02.00; MTR-CODE: DW10ATED;DW10BTED; FOR: DELPHI; + AC	6 PK 1751
				ALT	FROM: 02.00; MTR-CODE: DW10ATED;DW10BTED; FOR: SANDEN; + AC	6 PK 1740
				ALT	FROM: 12.03; MTR-CODE: DW10BTED; + AC	6 PK 1740
				ALT	MTR-CODE: DW10BTED; - AC	6 PK 1470
				ALT	UNTIL: 11.03; MTR-CODE: DW10BTED; FOR: DELPHI; + AC	6 PK 1751
				ALT	UNTIL: 11.03; MTR-CODE: DW10BTED; FOR: SANDEN; + AC	6 PK 1740
				CAM	MTR-CODE: DW10ATED;DW10BTED	ZRK 1352
				CAM	MTR-CODE: DW10ATED4	ZRK 1441
				CAM	FROM ORGA-NO.: 10011; MTR-CODE: DW10ATED4	KT 1480
				CAM	MTR-CODE: DW10ATED; UNTIL ORGA-NO.: 08560	KT 1327
				CAM	MTR-CODE: DW10ATED4; UNTIL ORGA-NO.: 10010	KT 1351
				CAM	MTR-CODE: DW10BTED; FROM ORGA-NO.: 09868	KT 1327
				W-P; CAM	FROM ORGA-NO.: 09868	KT 1327 W1
				W-P; CAM	UNTIL ORGA-NO.: 09867	KT 1518 W1

2.0 HDi 110						
1997 ccm	80 kW	RHZ (DW10ATED)	01.02 -	ALT	FROM: 12.03; MTR-CODE: DW10CTED; - AC	6 PK 1470
				ALT	FROM: 12.03; MTR-CODE: DW10CTED; + AC	6 PK 1740
				CAM		ZRK 1352
				CAM	MTR-CODE: DW10ATED; UNTIL ORGA-NO.: 08560	KT 1327
				CAM	MTR-CODE: DW10BTED; FROM ORGA-NO.: 09868	KT 1327
				CAM	MTR-CODE: DW10CTED	KT 1534 W1
				W-P; CAM	FROM ORGA-NO.: 08561	KT 1518 W1
				W-P; CAM	UNTIL ORGA-NO.: 08560	KT 1327 W1

2.0 HDi 110						
1997 ccm	80 kW	RHW (DW10ATED4)	01.02 -	W-P; CAM	FROM ORGA-NO.: 10011	KT 1480 W1

### JUMPY Pritsche/Fahrgestell (BU\_, BV\_, BW\_, BX\_)

2.0						
1997 ccm	100 kW	RFN (EW10J4)	12.03 -	ALT	- AC	6 PK 1190
				ALT	+ AC	6 PK 1710
				CAM		ZRK 1149



## CITROËN

### JUMPY Pritsche/Fahrgestell (BU\_, BV\_, BW\_, BX\_)

<b>2.0</b>						
1997 ccm	100 kW	RFN (EW10J4)	12.03 -	CAM		KT 1244
<b>1.9 TD</b>						
1905 ccm	68 kW	D8B (XUD9TF)	10.99 -	ALT	- AC; - PS	6 PK 730
				ALT	+ AC; - PS	6 PK 1165
				ALT	+ AC; + PS	6 PK 1740
				ALT	+ PS; - AC	6 PK 1115
				CAM		ZRK 1262
				CAM		KT 1040
				W-P; CAM		KT 1040 W1
<b>2.0 HDi 95</b>						
1997 ccm	69 kW	RHX (DW10BTED)	10.99 -	ALT	FROM: 02.00; MTR-CODE: DW10ATED;DW10BTED; - AC	6 PK 1470
				ALT	FROM: 02.00; MTR-CODE: DW10ATED;DW10BTED; FOR: DELPHI; + AC	6 PK 1751
				ALT	FROM: 02.00; MTR-CODE: DW10ATED;DW10BTED; FOR: SANDEN; + AC	6 PK 1740
				ALT	FROM: 02.00; MTR-CODE: DW10BTED; - AC	6 PK 1470
				ALT	FROM: 02.00; MTR-CODE: DW10BTED; + AC	6 PK 1740
				ALT	FROM: 02.00; UNTIL: 11.03; MTR-CODE: DW10BTED; FOR: DELPHI; + AC	6 PK 1751
				CAM	MTR-CODE: DW10ATED;DW10BTED	ZRK 1352
				CAM	MTR-CODE: DW10ATED4	ZRK 1441
				CAM	MTR-CODE: DW10ATED; UNTIL ORGA-NO.: 08560	KT 1327
				CAM	MTR-CODE: DW10ATED4; FROM ORGA-NO.: 10011	KT 1480
				CAM	MTR-CODE: DW10ATED4; UNTIL ORGA-NO.: 10010	KT 1351
				CAM	MTR-CODE: DW10BTED; FROM ORGA-NO.: 09868	KT 1327
				W-P; CAM	FROM ORGA-NO.: 09868	KT 1327 W1
<b>2.0 HDi 110 16V</b>						
1997 ccm	80 kW	RHZ (DW10ATED)	12.03 -	ALT	- AC	6 PK 1470
				ALT	+ AC	6 PK 1740
				CAM	FROM ORGA-NO.: 08561	KT 1518
				CAM	MTR-CODE: DW10CTED	KT 1534 W1
				W-P; CAM	FROM ORGA-NO.: 08561	KT 1518 W1
				W-P; CAM	MTR-CODE: RHZ; UNTIL ORGA-NO.: 08560	KT 1327 W1
<b>2.0 HDi 110</b>						
1997 ccm	80 kW	RHW (DW10ATED4)	12.03 -	W-P; CAM	FROM ORGA-NO.: 10011	KT 1480 W1
<b>JUMPY</b>						
<b>2.0 i</b>						
1997 ccm	103 kW	RFH (EW10A)	01.07 -	ALT	MTR-CODE: EW10AB4	6 PK 1000
				CAM	MTR-CODE: EW10A	ZRK 1588
				CAM		KT 1504
				W-P; CAM		KT 1504 W1
<b>1.6 HDi 90</b>						
1560 ccm	66 kW	9HU (DV6UTED4)	01.07 -	ALT	MTR-CODE: DV6UTED4; - AC	6 PK 1352
				ALT	MTR-CODE: DV6UTED4; + AC	6 PK 1710
				CAM		ZRK 1460
				CAM		KT 1390
				W-P; CAM		KT 1390 W1
<b>2.0 HDi 95</b>						
1997 ccm	72 kW		07.11 -	CAM		ZRK 1592
				CAM		KT 1500
<b>2.0 HDi 120</b>						
1997 ccm	88 kW	RHK (DW10UTED4)	01.07 -	ALT		6 PK 1215
				CAM		ZRK 1452
				CAM		KT 1428
				W-P; CAM		KT 1428 W1
<b>2.0 HDi 125</b>						
1997 ccm	94 kW		07.11 -	CAM		ZRK 1592
				CAM		KT 1500
<b>2.0 HDi 140</b>						
1997 ccm	100 kW	RHR (DW10BTED4)	01.07 -	ALT		6 PK 1215
				CAM		ZRK 1452
				CAM	MTR-CODE: DW10CTED4	ZRK 1592



## CITROËN

### JUMPY

#### 2.0 HDi 140

1997 ccm	100 kW	RHR (DW10BTED4)	01.07 -	CAM		KT 1428
				CAM	MTR-CODE: DW10CTED4	KT 1500
				W-P; CAM		KT 1428 W1

#### 2.0 HDi 165

1997 ccm	120 kW	RHH (DW10CTED4)	07.10 -	CAM		ZRK 1592
				CAM		KT 1500

### JUMPY Kasten

#### 2.0 i

1997 ccm	103 kW	RFH (EW10A)	01.07 -	ALT		6 PK 1000
				W-P; CAM		KT 1504 W1

#### 1.6 HDi 90

1560 ccm	66 kW	9HU (DV6UTED4)	01.07 -	ALT	MTR-CODE: DV6UTED4; - AC	6 PK 1352
				ALT	MTR-CODE: DV6UTED4; + AC	6 PK 1710
				CAM		ZRK 1460
				CAM		KT 1390
				W-P; CAM		KT 1390 W1

#### 2.0 HDi 95

1997 ccm	72 kW		07.11 -	CAM		ZRK 1592
				CAM		KT 1500
				CAM	MTR-CODE: DW10BTED	KT 1534 W1

#### 2.0 HDi 120

1997 ccm	88 kW	RHK (DW10UTED4)	01.07 -	ALT		6 PK 1215
				CAM	MTR-CODE: DW10BTED4FAP	ZRK 1452
				CAM	MTR-CODE: DW10BTED4FAP	KT 1428
				W-P; CAM		KT 1428 W1

#### 2.0 HDi 125

1997 ccm	94 kW		07.11 -	CAM		ZRK 1592
				CAM		KT 1500

#### 2.0 HDi 140

1997 ccm	100 kW	RHR (DW10BTED4)	01.07 -	ALT		6 PK 1215
				CAM		ZRK 1452
				CAM	MTR-CODE: DW10CTED4	ZRK 1592
				CAM		KT 1428
				CAM	MTR-CODE: DW10CTED4	KT 1500
				W-P; CAM		KT 1428 W1

#### 2.0 HDi 165

1997 ccm	120 kW	RHH (DW10CTED4)	07.10 -	CAM		ZRK 1592
				CAM		KT 1500

### JUMPER Bus (230P)

#### 2.0

1998 ccm	80 kW	RFW (XU10J2U)	02.94 - 04.02	PS		AVX 10 x 715
				ALT	FROM: 10.95; MTR-CODE: XU10J2C; MOD: 35; - AC	6 PK 698
				ALT	FROM: 10.95; MTR-CODE: XU10J2C; MOD: 35; + AC	6 PK 1100
				ALT	MTR-CODE: XU10J2C; MOD: 27; - AC	6 PK 698
				ALT	MTR-CODE: XU10J2C; MOD: 27; + AC	6 PK 1100
				PS	FROM: 12.96; MTR-CODE: XU10J2C; MOD: 27	4 PK 755
				CAM		ZRK 1127
				CAM		KT 1522

#### 2.0 4x4

1998 ccm	80 kW	RFW (XU10J2U)	08.96 - 04.02	PS		AVX 10 x 715
				ALT	FROM: 09.97; MTR-CODE: XU10J2C; MOD: 27	4 PK 755
				ALT	FROM: 09.97; MTR-CODE: XU10J2C; MOD: 27; - AC	6 PK 698
				ALT	FROM: 09.97; MTR-CODE: XU10J2C; MOD: 27; + AC	6 PK 1100
				ALT	MTR-CODE: XU10J2C; MOD: 31; - AC	6 PK 698
				ALT	MTR-CODE: XU10J2C; MOD: 31; + AC	6 PK 1100
				PS	FROM: 12.96; MTR-CODE: XU10J2C; MOD: 31	4 PK 755
				CAM		ZRK 1127
				CAM		KT 1522

#### 1.9 D

1905 ccm	51 kW	D9B (XUD9A/U)	01.99 - 04.02	ALT	AMP: 120; MOD: 1000; + AC	6 PK 1153
				ALT	AMP: 80; MOD: 1000; + AC	6 PK 1145





## CITROËN

### JUMPER Bus (230P)

#### 1.9 D

1905 ccm	51 kW	D9B (XUD9A/U)	01.99 - 04.02	ALT	MOD: 1000; - AC	6 PK 730
				PS	MOD: 1000	4 PK 755
				CAM		ZRK 1262
				CAM		KT 1040
				W-P; CAM		KT 1040 W3

#### 1.9 TD

1905 ccm	66 kW	D8C (XUD9UTF)	08.94 - 04.02	PS		AVX 10 x 715
				VAC-P		AVX 10 x 650
				ALT	MTR-CODE: XUD9TF; AMP: 120; MOD: 27; + AC	6 PK 1153
				ALT	MTR-CODE: XUD9TF; AMP: 120; MOD: 31; + AC	6 PK 1153
				ALT	MTR-CODE: XUD9TF; AMP: 80; MOD: 27; + AC	6 PK 1145
				ALT	MTR-CODE: XUD9TF; AMP: 80; MOD: 31; + AC	6 PK 1145
				ALT	MTR-CODE: XUD9TF; MOD: 27; - AC	6 PK 730
				ALT	MTR-CODE: XUD9TF; MOD: 31; - AC	6 PK 730
				CAM		ZRK 1262
				CAM		KT 1040
				W-P; CAM	FROM: 02.97	KT 1040 W3
				W-P; CAM	UNTIL: 01.97	KT 1040 W1

#### 1.9 TD

1905 ccm	68 kW	D8C (XUD9UTF)	02.94 - 04.02	PS		AVX 10 x 715
				VAC-P		AVX 10 x 650
				ALT	AMP: 120; MOD: 31; + AC	6 PK 1153
				ALT	AMP: 80; MOD: 31; + AC	6 PK 1145
				ALT	MOD: 31; - AC	6 PK 730
				PS	FROM: 12.96; MOD: 31	4 PK 755
				CAM		ZRK 1262
				CAM		KT 1040
				W-P; CAM	FROM: 02.97	KT 1040 W3
				W-P; CAM	UNTIL: 01.97	KT 1040 W1

#### 1.9 TD 4x4

1905 ccm	68 kW	D8C (XUD9UTF)	08.96 - 04.02	PS		AVX 10 x 715
				VAC-P		AVX 10 x 650
				ALT	MOD: 31; - AC	6 PK 730
				ALT	MTR-CODE: XUD9TE; AMP: 120; MOD: 31; + AC	6 PK 1153
				ALT	MTR-CODE: XUD9TE; AMP: 80; MOD: 31; + AC	6 PK 1145
				PS	FROM: 12.96; MOD: 31	4 PK 755
				CAM		ZRK 1262
				CAM		KT 1040
				W-P; CAM	FROM: 02.97	KT 1040 W3
				W-P; CAM	UNTIL: 01.97	KT 1040 W1

#### 2.5 D

2446 ccm	63 kW	T9A (DJ5)	08.94 - 04.02	AC-C	FROM: 06.95; MOD: 1800	6 PK 913
				AC-C	FROM: 06.95; UNTIL: 11.95; MOD: 1800	6 PK 913
				AC-C	FROM: 10.95; MOD: 35	6 PK 913
				AC-C	FROM: 10.95; UNTIL: 11.95; MOD: 35	6 PK 913
				AC-C	MOD: 1400	6 PK 913
				AC-C	MOD: 31	6 PK 913
				ALT	FROM: 06.95; MOD: 1800; - PS	6 PK 800
				ALT	FROM: 06.95; MOD: 1800; + PS	6 PK 1010
				ALT	FROM: 10.95; MOD: 35; - PS	6 PK 800
				ALT	FROM: 10.95; MOD: 35; + PS	6 PK 1010
				ALT	MOD: 1400; - PS	6 PK 800
				ALT	MOD: 1400; + PS	6 PK 1010
				ALT	MOD: 31; - PS	6 PK 800
				ALT	MOD: 31; + PS	6 PK 1010
				VAC-P	UNTIL: 11.95; MOD: 1400	6 PK 913
				VAC-P	UNTIL: 11.95; MOD: 31	6 PK 913
				W-P	FROM: 05.96; MOD: 1400	3 PK 866
				W-P	FROM: 05.96; MOD: 1800	3 PK 866
				W-P	FROM: 05.96; MOD: 31	3 PK 866
				W-P	FROM: 05.96; MOD: 35	3 PK 866
				W-P	FROM: 06.95; UNTIL: 05.96; MOD: 1800	4 PK 855
				W-P	FROM: 10.95; UNTIL: 05.96; MOD: 35	4 PK 855
				W-P	UNTIL: 05.96; MOD: 1400	4 PK 855
				W-P	UNTIL: 05.96; MOD: 31	4 PK 855
				CAM		ZRK 1141



## CITROËN

### JUMPER Bus (230P)

<b>2.5 D</b>						
2446 ccm	63 kW	T9A (DJ5)	08.94 - 04.02	CAM		KT 1083
<b>2.5 D 4x4</b>						
2446 ccm	63 kW	T9A (DJ5)	08.96 - 04.02	AC-C	MOD: 31	6 PK 913
				AC-C	MOD: 35	6 PK 913
				ALT	MOD: 31; - PS	6 PK 800
				ALT	MOD: 31; + PS	6 PK 1010
				ALT	MOD: 35; - PS	6 PK 800
				ALT	MOD: 35; + PS	6 PK 1010
				W-P	MOD: 31	3 PK 866
				W-P	MOD: 35	3 PK 866
				CAM		ZRK 1141
				CAM		KT 1083
<b>2.5 TD</b>						
2446 ccm	76 kW	T8A (DJ5T)	08.94 - 04.02	AC-C	FROM: 06.95; MOD: 1800	6 PK 913
				AC-C	FROM: 06.95; UNTIL: 11.95; MOD: 1800	6 PK 913
				AC-C	FROM: 10.95; MOD: 35	6 PK 913
				AC-C	FROM: 10.95; UNTIL: 11.95; MOD: 35	6 PK 913
				AC-C	MOD: 1400	6 PK 913
				AC-C	MOD: 27	6 PK 913
				AC-C	MOD: 31	6 PK 913
				ALT	FROM: 06.95; MOD: 1800; - PS	6 PK 800
				ALT	FROM: 06.95; MOD: 1800; + PS	6 PK 1010
				ALT	FROM: 10.95; MOD: 35; - PS	6 PK 800
				ALT	FROM: 10.95; MOD: 35; + PS	6 PK 1010
				ALT	MOD: 1400; - PS	6 PK 800
				ALT	MOD: 1400; + PS	6 PK 1010
				ALT	MOD: 27; - PS	6 PK 800
				ALT	MOD: 27; + PS	6 PK 1010
				ALT	MOD: 31; - PS	6 PK 800
				ALT	MOD: 31; + PS	6 PK 1010
				VAC-P	UNTIL: 11.95; MOD: 1400	6 PK 913
				VAC-P	UNTIL: 11.95; MOD: 27	6 PK 913
				VAC-P	UNTIL: 11.95; MOD: 31	6 PK 913
				W-P	FROM: 05.96; MOD: 1400	3 PK 945
				W-P	FROM: 05.96; MOD: 1800	3 PK 945
				W-P	FROM: 05.96; MOD: 27	3 PK 945
				W-P	FROM: 05.96; MOD: 31	3 PK 945
				W-P	FROM: 05.96; MOD: 35	3 PK 945
				W-P	FROM: 06.95; UNTIL: 05.96; MOD: 1800	4 PK 950
				W-P	FROM: 10.95; UNTIL: 05.96; MOD: 35	4 PK 950
				W-P	UNTIL: 05.96; MOD: 1400	4 PK 950
				W-P	UNTIL: 05.96; MOD: 27	4 PK 950
				W-P	UNTIL: 05.96; MOD: 31	4 PK 950
				CAM		ZRK 1141
				CAM		KT 1083
<b>2.5 TD 4x4</b>						
2446 ccm	76 kW	T8A (DJ5T)	08.96 - 04.02	AC-C	MOD: 31	6 PK 913
				AC-C	MOD: 35	6 PK 913
				ALT	MOD: 31; - PS	6 PK 800
				ALT	MOD: 31; + PS	6 PK 1010
				ALT	MOD: 35; - PS	6 PK 800
				ALT	MOD: 35; + PS	6 PK 1010
				W-P	MOD: 31	3 PK 945
				W-P	MOD: 35	3 PK 945
				CAM		ZRK 1141
				CAM		KT 1083
<b>2.5 TDi</b>						
2446 ccm	79 kW	THX (DJ5TED)	12.96 - 11.00	AC-C	FROM: 11.97; MOD: 1400	6 PK 913
				AC-C	MOD: 1800	6 PK 913
				AC-C	MOD: 27	6 PK 913
				AC-C	MOD: 31	6 PK 913
				AC-C	MOD: 35	6 PK 913
				ALT	FROM: 11.97; MOD: 1400; - PS	6 PK 800
				ALT	FROM: 11.97; MOD: 1400; + PS	6 PK 1010
				ALT	MOD: 1800; - PS	6 PK 800
				ALT	MOD: 1800; + PS	6 PK 1010
				ALT	MOD: 27; - PS	6 PK 800



## CITROËN

### JUMPER Bus (230P)

#### 2.5 TDi

2446 ccm	79 kW	THX (DJ5TED)	12.96 - 11.00	ALT	MOD: 27; + PS	6 PK 1010
				ALT	MOD: 31; - PS	6 PK 800
				ALT	MOD: 31; + PS	6 PK 1010
				ALT	MOD: 35; - PS	6 PK 800
				ALT	MOD: 35; + PS	6 PK 1010
				W-P	FROM: 11.97; MOD: 1400	3 PK 945
				W-P	MOD: 1800	3 PK 945
				W-P	MOD: 27	3 PK 945
				W-P	MOD: 31	3 PK 945
				W-P	MOD: 35	3 PK 945
				CAM		ZRK 1078
				CAM		KT 1310

#### 2.5 TDi 4x4

2446 ccm	79 kW	THX (DJ5TED)	12.96 - 11.00	AC-C	MOD: 31	6 PK 913
				AC-C	MOD: 35	6 PK 913
				ALT	MOD: 31; - PS	6 PK 800
				ALT	MOD: 31; + PS	6 PK 1010
				ALT	MOD: 35; - PS	6 PK 800
				ALT	MOD: 35; + PS	6 PK 1010
				W-P	MOD: 31	3 PK 945
				W-P	MOD: 35	3 PK 945
				CAM		ZRK 1078
				CAM		KT 1310

#### 2.8 HDi

2798 ccm	94 kW	8140.43S	09.00 - 04.02	AC-C	MOD: 1000	5 PK 1104
				AC-C	MOD: 1400	5 PK 1104
				AC-C	MOD: 1800	5 PK 1104
				AC-C	MOD: 27	5 PK 1104
				AC-C	MOD: 31	5 PK 1104
				AC-C	MOD: 35	5 PK 1104
				ALT	FROM MTR-NO: 2976898; MOD: 1000	6 PK 950
				ALT	FROM MTR-NO: 2976898; MOD: 1400	6 PK 950
				ALT	FROM MTR-NO: 2976898; MOD: 1800	6 PK 950
				ALT	FROM MTR-NO: 2976898; MOD: 27	6 PK 950
				ALT	FROM MTR-NO: 2976898; MOD: 31	6 PK 950
				ALT	FROM MTR-NO: 2976898; MOD: 35	6 PK 950
				ALT	UNTIL MTR-NO: 2976897; MOD: 1000	6 PK 913
				ALT	UNTIL MTR-NO: 2976897; MOD: 1400	6 PK 913
				ALT	UNTIL MTR-NO: 2976897; MOD: 1800	6 PK 913
				ALT	UNTIL MTR-NO: 2976897; MOD: 27	6 PK 913
				ALT	UNTIL MTR-NO: 2976897; MOD: 31	6 PK 913
				ALT	UNTIL MTR-NO: 2976897; MOD: 35	6 PK 913
				CAM		ZRK 1312
				CAM		KT 1229

#### 2.8 HDi 4x4

2798 ccm	94 kW	8140.43S	09.00 - 04.02	AC-C	MOD: 1800	5 PK 1104
				AC-C	MOD: 35	5 PK 1104
				ALT	FROM MTR-NO: 2976898; MOD: 1800	6 PK 950
				ALT	FROM MTR-NO: 2976898; MOD: 35	6 PK 950
				ALT	UNTIL MTR-NO: 2976897; MOD: 1800	6 PK 913
				ALT	UNTIL MTR-NO: 2976897; MOD: 35	6 PK 913
				CAM		ZRK 1312
				CAM		KT 1229

### JUMPER Kasten (230L)

#### 2.0

1998 ccm	80 kW	RFW (XU10J2U)	03.94 - 04.02	PS		AVX 10 x 715
				ALT	FROM: 12.96; MTR-CODE: XU10J2C; MOD: 31	4 PK 755
				ALT	FROM: 12.96; MTR-CODE: XU10J2C; MOD: 35	4 PK 755
				ALT	MTR-CODE: XU10J2C; MOD: 27; - AC	6 PK 698
				ALT	MTR-CODE: XU10J2C; MOD: 27; + AC	6 PK 1100
				ALT	MTR-CODE: XU10J2C; MOD: 31; - AC	6 PK 698
				ALT	MTR-CODE: XU10J2C; MOD: 31; + AC	6 PK 1100
				ALT	MTR-CODE: XU10J2C; MOD: 35; - AC	6 PK 698
				ALT	MTR-CODE: XU10J2C; MOD: 35; + AC	6 PK 1100
				PS	FROM: 12.96; MTR-CODE: XU10J2C; MOD: 27	4 PK 755
				CAM		ZRK 1127



## CITROËN

### JUMPER Kasten (230L)

#### 2.0

1998 ccm	80 kW	RFW (XU10J2U)	03.94 - 04.02	CAM		KT 1522
----------	-------	---------------	---------------	-----	--	---------

#### 1.9 D

1905 ccm	50 kW	DJY (XUD9A)	07.99 - 04.02	ALT	MOD: 27; - AC	6 PK 730
				ALT	MTR-CODE: XUD9A;XUD9AU; AMP: 120; MOD: 27; + AC	6 PK 1153
				ALT	MTR-CODE: XUD9A;XUD9AU; AMP: 80; MOD: 27; + AC	6 PK 1145
				PS	MOD: 27	4 PK 755
				CAM		ZRK 1262
				CAM		KT 1040
				W-P; CAM		KT 1040 W3

#### 1.9 D

1905 ccm	51 kW	D9B (XUD9A/U)	02.94 - 04.02	PS	UNTIL: 12.96	AVX 10 x 715
				ALT	AMP: 120; MOD: 1000; + AC	6 PK 1153
				ALT	AMP: 120; MOD: 27; + AC	6 PK 1153
				ALT	AMP: 80; MOD: 1000; + AC	6 PK 1145
				ALT	AMP: 80; MOD: 27; + AC	6 PK 1145
				ALT	MOD: 1000; - AC	6 PK 730
				ALT	MOD: 27; - AC	6 PK 730
				PS	FROM: 12.96; MOD: 1000	4 PK 755
				PS	FROM: 12.96; MOD: 27	4 PK 755
				CAM		ZRK 1262
				CAM		KT 1040
				W-P; CAM	FROM: 02.97	KT 1040 W3
				W-P; CAM	UNTIL: 01.97	KT 1040 W1

#### 1.9 TD

1905 ccm	66 kW	DHX (XUD9TF/BTF)	03.94 - 04.02	ALT	AMP: 120; MOD: 27; + AC	6 PK 1153
				ALT	AMP: 80; MOD: 27; + AC	6 PK 1145
				ALT	MOD: 27; - AC	6 PK 730
				CAM		ZRK 1262
				CAM		KT 1040
				W-P; CAM		KT 1040 W3
				W-P; CAM	UNTIL: 01.97	KT 1040 W1

#### 1.9 TD

1905 ccm	68 kW	D8C (XUD9UTF)	03.94 - 04.02	PS	UNTIL: 12.96	AVX 10 x 715
				ALT	AMP: 120; MOD: 27; + AC	6 PK 1153
				ALT	AMP: 80; MOD: 27; + AC	6 PK 1145
				ALT	MOD: 27; - AC	6 PK 730
				PS	FROM: 12.96; MOD: 27	4 PK 755
				CAM		ZRK 1262
				CAM		KT 1040
				W-P; CAM	FROM: 02.97	KT 1040 W3
				W-P; CAM	UNTIL: 01.97	KT 1040 W1

#### 2.0 HDI

1997 ccm	62 kW	RHV (DW10UTD)	11.01 - 04.02	ALT	- AC	6 PK 1470
				ALT	+ AC	6 PK 1185
				PS	FROM CHA-NO.: 17431901	4 PK 755
				CAM	MTR-CODE: DW10TD	ZRK 1352
				CAM	MTR-CODE: DW10TD	KT 1327
				W-P; CAM		KT 1327 W1

#### 2.5 D

2446 ccm	63 kW	T9A (DJ5)	03.94 - 04.02	AC-C	MOD: 1400	6 PK 913
				AC-C	MOD: 1800	6 PK 913
				AC-C	MOD: 31	6 PK 913
				AC-C	MOD: 35	6 PK 913
				ALT	MOD: 1400; - PS	6 PK 800
				ALT	MOD: 1400; + PS	6 PK 1010
				ALT	MOD: 1800; - PS	6 PK 800
				ALT	MOD: 1800; + PS	6 PK 1010
				ALT	MOD: 31; - PS	6 PK 800
				ALT	MOD: 31; + PS	6 PK 1010
				ALT	MOD: 35; - PS	6 PK 800
				ALT	MOD: 35; + PS	6 PK 1010
				VAC-P	UNTIL: 11.95; MOD: 1400	6 PK 913
				VAC-P	UNTIL: 11.95; MOD: 1800	6 PK 913
				VAC-P	UNTIL: 11.95; MOD: 31	6 PK 913
				VAC-P	UNTIL: 11.95; MOD: 35	6 PK 913



## CITROËN

### JUMPER Kasten (230L)

#### 2.5 D

2446 ccm	63 kW	T9A (DJ5)	03.94 - 04.02	W-P	FROM: 05.96; MOD: 1400	3 PK 866
				W-P	FROM: 05.96; MOD: 1800	3 PK 866
				W-P	FROM: 05.96; MOD: 31	3 PK 866
				W-P	FROM: 05.96; MOD: 35	3 PK 866
				W-P	UNTIL: 05.96; MOD: 1400	4 PK 855
				W-P	UNTIL: 05.96; MOD: 1800	4 PK 855
				W-P	UNTIL: 05.96; MOD: 31	4 PK 855
				W-P	UNTIL: 05.96; MOD: 35	4 PK 855
				CAM		ZRK 1141
				CAM		KT 1083

#### 2.5 D 4x4

2446 ccm	63 kW	T9A (DJ5)	03.00 - 04.02	AC-C	MOD: 31	6 PK 913
				AC-C	MOD: 35	6 PK 913
				ALT	MOD: 31; - PS	6 PK 800
				ALT	MOD: 31; + PS	6 PK 1010
				ALT	MOD: 35; - PS	6 PK 800
				ALT	MOD: 35; + PS	6 PK 1010
				W-P	MOD: 31	3 PK 866
				W-P	MOD: 35	3 PK 866
				CAM		ZRK 1141
				CAM		KT 1083

#### 2.5 TD

2446 ccm	76 kW	T8A (DJ5T)	03.94 - 04.02	AC-C	MOD: 1400	6 PK 913
				AC-C	MOD: 1800	6 PK 913
				AC-C	MOD: 31	6 PK 913
				AC-C	MOD: 35	6 PK 913
				ALT	MOD: 1400; - PS	6 PK 800
				ALT	MOD: 1400; + PS	6 PK 1010
				ALT	MOD: 1800; - PS	6 PK 800
				ALT	MOD: 1800; + PS	6 PK 1010
				ALT	MOD: 31; - PS	6 PK 800
				ALT	MOD: 31; + PS	6 PK 1010
				ALT	MOD: 35; - PS	6 PK 800
				ALT	MOD: 35; + PS	6 PK 1010
				VAC-P	UNTIL: 11.95; MOD: 1400	6 PK 913
				VAC-P	UNTIL: 11.95; MOD: 1800	6 PK 913
				VAC-P	UNTIL: 11.95; MOD: 31	6 PK 913
				VAC-P	UNTIL: 11.95; MOD: 35	6 PK 913
				W-P	FROM: 05.96; MOD: 1400	3 PK 945
				W-P	FROM: 05.96; MOD: 1800	3 PK 945
				W-P	FROM: 05.96; MOD: 31	3 PK 945
				W-P	FROM: 05.96; MOD: 35	3 PK 945
				W-P	UNTIL: 05.96; MOD: 1400	4 PK 950
				W-P	UNTIL: 05.96; MOD: 1800	4 PK 950
				W-P	UNTIL: 05.96; MOD: 31	4 PK 950
				W-P	UNTIL: 05.96; MOD: 35	4 PK 950
				CAM		ZRK 1141
				CAM		KT 1083

#### 2.5 DT 4x4

2446 ccm	76 kW		10.96 - 08.97	AC-C	MTR-CODE: DJ5T; MOD: 31	6 PK 913
				AC-C	MTR-CODE: DJ5T; MOD: 35	6 PK 913
				ALT	MTR-CODE: DJ5T; MOD: 31; - PS	6 PK 800
				ALT	MTR-CODE: DJ5T; MOD: 31; + PS	6 PK 1010
				ALT	MTR-CODE: DJ5T; MOD: 35; - PS	6 PK 800
				ALT	MTR-CODE: DJ5T; MOD: 35; + PS	6 PK 1010
				W-P	MTR-CODE: DJ5T; MOD: 31	3 PK 945
				W-P	MTR-CODE: DJ5T; MOD: 35	3 PK 945
				CAM		ZRK 1141
				CAM		KT 1083

#### 2.5 TDi

2446 ccm	79 kW	THX (DJ5TED)	12.96 - 11.00	AC-C	FROM: 11.97; MOD: 1400	6 PK 913
				AC-C	FROM: 11.97; MOD: 1800	6 PK 913
				AC-C	MOD: 31	6 PK 913
				AC-C	MOD: 35	6 PK 913
				ALT	FROM: 11.97; MOD: 1400; - PS	6 PK 800
				ALT	FROM: 11.97; MOD: 1400; + PS	6 PK 1010
				ALT	FROM: 11.97; MOD: 1800; - PS	6 PK 800



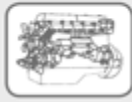

## CITROËN

### JUMPER Kasten (230L)

2.5 TDi						
2446 ccm	79 kW	THX (DJ5TED)	12.96 - 11.00	ALT	FROM: 11.97; MOD: 1800; + PS	6 PK 1010
				ALT	MOD: 31; - PS	6 PK 800
				ALT	MOD: 31; + PS	6 PK 1010
				ALT	MOD: 35; - PS	6 PK 800
				ALT	MOD: 35; + PS	6 PK 1010
				W-P	FROM: 11.97; MOD: 1400	3 PK 945
				W-P	FROM: 11.97; MOD: 1800	3 PK 945
				W-P	MOD: 31	3 PK 945
				W-P	MOD: 35	3 PK 945
				CAM		ZRK 1078
				CAM		KT 1310

2.5 TDi 4x4						
2446 ccm	79 kW	THX (DJ5TED)	03.00 - 11.00	AC-C	MOD: 31	6 PK 913
				AC-C	MOD: 35	6 PK 913
				ALT	MOD: 31; - PS	6 PK 800
				ALT	MOD: 31; + PS	6 PK 1010
				ALT	MOD: 35; - PS	6 PK 800
				ALT	MOD: 35; + PS	6 PK 1010
				W-P	MOD: 31	3 PK 945
				W-P	MOD: 35	3 PK 945
				CAM		ZRK 1078
				CAM		KT 1310

2.8 HDi						
2798 ccm	94 kW	8140.43S	09.00 - 04.02	AC-C	MOD: 1000	5 PK 1104
				AC-C	MOD: 1400	5 PK 1104
				AC-C	MOD: 1800	5 PK 1104
				AC-C	MOD: 27	5 PK 1104
				AC-C	MOD: 31	5 PK 1104
				AC-C	MOD: 35	5 PK 1104
				ALT	FROM MTR-NO: 2976898; MOD: 1000	6 PK 950
				ALT	FROM MTR-NO: 2976898; MOD: 1400	6 PK 950
				ALT	FROM MTR-NO: 2976898; MOD: 1800	6 PK 950
				ALT	FROM MTR-NO: 2976898; MOD: 27	6 PK 950
				ALT	FROM MTR-NO: 2976898; MOD: 31	6 PK 950
				ALT	FROM MTR-NO: 2976898; MOD: 35	6 PK 950
				ALT	UNTIL MTR-NO: 2976897; MOD: 1000	6 PK 913
				ALT	UNTIL MTR-NO: 2976897; MOD: 1400	6 PK 913
				ALT	UNTIL MTR-NO: 2976897; MOD: 1800	6 PK 913
				ALT	UNTIL MTR-NO: 2976897; MOD: 27	6 PK 913
				ALT	UNTIL MTR-NO: 2976897; MOD: 31	6 PK 913
				ALT	UNTIL MTR-NO: 2976897; MOD: 35	6 PK 913
				CAM		ZRK 1312
				CAM		KT 1229

2.8 HDi 4x4						
2798 ccm	94 kW	8140.43S	09.00 - 04.02	AC-C	MOD: 1400	5 PK 1104
				AC-C	MOD: 1800	5 PK 1104
				AC-C	MOD: 31	5 PK 1104
				AC-C	MOD: 35	5 PK 1104
				ALT	FROM MTR-NO: 2976898; MOD: 1400	6 PK 950
				ALT	FROM MTR-NO: 2976898; MOD: 1800	6 PK 950
				ALT	FROM MTR-NO: 2976898; MOD: 31	6 PK 950
				ALT	FROM MTR-NO: 2976898; MOD: 35	6 PK 950
				ALT	UNTIL MTR-NO: 2976897; MOD: 1400	6 PK 913
				ALT	UNTIL MTR-NO: 2976897; MOD: 1800	6 PK 913
				ALT	UNTIL MTR-NO: 2976897; MOD: 31	6 PK 913
				ALT	UNTIL MTR-NO: 2976897; MOD: 35	6 PK 913
				CAM		ZRK 1312
				CAM		KT 1229

### JUMPER Pritsche/Fahrgestell (230)

2.0						
1998 ccm	80 kW	RFW (XU10J2U)	03.94 - 04.02	ALT	MTR-CODE: XU10J2C; MOD: 31; - AC	6 PK 698
				ALT	MTR-CODE: XU10J2C; MOD: 31; + AC	6 PK 1100
				ALT	MTR-CODE: XU10J2C; MOD: 35; - AC	6 PK 698
				ALT	MTR-CODE: XU10J2C; MOD: 35; + AC	6 PK 1100
				PS	FROM: 12.96; MTR-CODE: XU10J2C; MOD: 31	4 PK 755
				PS	FROM: 12.96; MTR-CODE: XU10J2C; MOD: 35	4 PK 755

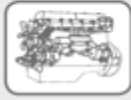

## CITROËN

### JUMPER Pritsche/Fahrgestell (230)

<b>2.0</b>						
1998 ccm	80 kW	RFW (XU10J2U)	03.94 - 04.02	CAM CAM		ZRK 1127 KT 1522
<b>1.9 TD</b>						
1905 ccm	66 kW	DHX (XUD9TF/BTF)	03.94 - 04.02	ALT ALT ALT CAM CAM W-P; CAM W-P; CAM	AMP: 120; MOD: 31; + AC AMP: 80; MOD: 31; + AC MOD: 31; - AC  FROM: 02.97 UNTIL: 01.97	6 PK 1153 6 PK 1145 6 PK 730 ZRK 1262 KT 1040 KT 1040 W3 KT 1040 W1
<b>1.9 TD</b>						
1905 ccm	68 kW	D8C (XUD9UTF)	03.94 - 04.02	ALT ALT ALT CAM CAM W-P; CAM W-P; CAM	AMP: 120; MOD: 31; + AC AMP: 80; MOD: 31; + AC MOD: 31; - AC  FROM: 02.97 UNTIL: 01.97	6 PK 1153 6 PK 1145 6 PK 730 ZRK 1262 KT 1040 KT 1040 W3 KT 1040 W1
<b>2.5 D</b>						
2446 ccm	63 kW	T9A (DJ5)	03.94 - 04.02	PS AC-C AC-C AC-C AC-C ALT ALT ALT ALT ALT ALT ALT ALT ALT VAC-P VAC-P VAC-P VAC-P W-P W-P W-P W-P W-P W-P W-P W-P W-P CAM CAM	MOD: 1400 MOD: 1800 MOD: 31 MOD: 35 MOD: 1400; - PS MOD: 1400; + PS MOD: 1800; - PS MOD: 1800; + PS MOD: 31; - PS MOD: 31; + PS MOD: 35; - PS MOD: 35; + PS UNTIL: 11.95; MOD: 1400 UNTIL: 11.95; MOD: 1800 UNTIL: 11.95; MOD: 31 UNTIL: 11.95; MOD: 35 FROM: 05.96; MOD: 1400 FROM: 05.96; MOD: 1800 FROM: 05.96; MOD: 31 FROM: 05.96; MOD: 35 UNTIL: 05.96; MOD: 1400 UNTIL: 05.96; MOD: 1800 UNTIL: 05.96; MOD: 31 UNTIL: 05.96; MOD: 35	AVX 10 x 715 6 PK 913 6 PK 913 6 PK 913 6 PK 913 6 PK 800 6 PK 1010 6 PK 800 6 PK 1010 6 PK 800 6 PK 1010 6 PK 800 6 PK 1010 6 PK 913 6 PK 913 6 PK 913 6 PK 913 3 PK 866 3 PK 866 3 PK 866 3 PK 866 4 PK 855 4 PK 855 4 PK 855 4 PK 855 ZRK 1141 KT 1083
<b>2.5 D 4x4</b>						
2446 ccm	63 kW	T9A (DJ5)	03.00 - 04.02	AC-C AC-C ALT ALT ALT ALT W-P W-P CAM CAM	MOD: 31 MOD: 35 MOD: 31; - PS MOD: 31; + PS MOD: 35; - PS MOD: 35; + PS MOD: 31 MOD: 35	6 PK 913 6 PK 913 6 PK 800 6 PK 1010 6 PK 800 6 PK 1010 3 PK 866 3 PK 866 ZRK 1141 KT 1083
<b>2.5 TD</b>						
2446 ccm	76 kW	T8A (DJ5T)	03.94 - 04.02	PS AC-C AC-C AC-C ALT ALT ALT ALT	MOD: 1400 MOD: 31 MOD: 35 MOD: 1400; - PS MOD: 1400; + PS MOD: 31; - PS MOD: 31; + PS	AVX 10 x 715 6 PK 913 6 PK 913 6 PK 913 6 PK 800 6 PK 1010 6 PK 800 6 PK 1010

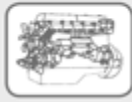

## CITROËN

### JUMPER Pritsche/Fahrgestell (230)

2.5 TD						
2446 ccm	76 kW	T8A (DJ5T)	03.94 - 04.02	ALT	MOD: 35; - PS	6 PK 800
				ALT	MOD: 35; + PS	6 PK 1010
				VAC-P	UNTIL: 11.95; MOD: 1400	6 PK 913
				VAC-P	UNTIL: 11.95; MOD: 31	6 PK 913
				VAC-P	UNTIL: 11.95; MOD: 35	6 PK 913
				W-P	FROM: 05.96; MOD: 1400	3 PK 945
				W-P	FROM: 05.96; MOD: 31	3 PK 945
				W-P	FROM: 05.96; MOD: 35	3 PK 945
				W-P	UNTIL: 05.96; MOD: 1400	4 PK 950
				W-P	UNTIL: 05.96; MOD: 31	4 PK 950
				W-P	UNTIL: 05.96; MOD: 35	4 PK 950
				CAM		ZRK 1141
				CAM		KT 1083

2.5 TDi						
2446 ccm	79 kW	THX (DJ5TED)	12.96 - 04.02	AC-C	FROM: 11.97; MOD: 1400	6 PK 913
				AC-C	MOD: 31	6 PK 913
				AC-C	MOD: 35	6 PK 913
				ALT	FROM: 11.97; MOD: 1400; - PS	6 PK 800
				ALT	FROM: 11.97; MOD: 1400; + PS	6 PK 1010
				ALT	MOD: 31; - PS	6 PK 800
				ALT	MOD: 31; + PS	6 PK 1010
				ALT	MOD: 35; - PS	6 PK 800
				ALT	MOD: 35; + PS	6 PK 1010
				W-P	FROM: 11.97; MOD: 1400	3 PK 945
				W-P	MOD: 31	3 PK 945
				W-P	MOD: 35	3 PK 945
				CAM		ZRK 1078
				CAM		KT 1310

2.5 TDi 4x4						
2446 ccm	79 kW	THX (DJ5TED)	03.00 - 04.02	AC-C	MOD: 31	6 PK 913
				AC-C	MOD: 35	6 PK 913
				ALT	MOD: 31; - PS	6 PK 800
				ALT	MOD: 31; + PS	6 PK 1010
				ALT	MOD: 35; - PS	6 PK 800
				ALT	MOD: 35; + PS	6 PK 1010
				W-P	MOD: 31	3 PK 945
				W-P	MOD: 35	3 PK 945
				CAM		ZRK 1078
				CAM		KT 1310

2.8 HDi						
2798 ccm	93 kW	8140.43S	10.00 - 01.02	AC-C	MOD: 31	5 PK 1104
				AC-C	MOD: 35	5 PK 1104
				ALT	FROM MTR-NO: 2976898; MOD: 31	6 PK 950
				ALT	FROM MTR-NO: 2976898; MOD: 35	6 PK 950
				ALT	UNTIL MTR-NO: 2976897; MOD: 31	6 PK 913
				ALT	UNTIL MTR-NO: 2976897; MOD: 35	6 PK 913
				CAM		ZRK 1312
				CAM		KT 1229

2.8 HDi						
2798 ccm	94 kW	8140.43S	09.00 - 04.02	AC-C	MOD: 1400	5 PK 1104
				AC-C	MOD: 1800	5 PK 1104
				AC-C	MOD: 31	5 PK 1104
				ALT	FROM MTR-NO: 2976898; MOD: 1400	6 PK 950
				ALT	FROM MTR-NO: 2976898; MOD: 1800	6 PK 950
				ALT	FROM MTR-NO: 2976898; MOD: 31	6 PK 950
				ALT	UNTIL MTR-NO: 2976897; MOD: 1400	6 PK 913
				ALT	UNTIL MTR-NO: 2976897; MOD: 1800	6 PK 913
				ALT	UNTIL MTR-NO: 2976897; MOD: 31	6 PK 913
				CAM		ZRK 1312
				CAM		KT 1229

### JUMPER Bus (244, Z\_)

2.0						
1998 ccm	81 kW	XU10J2	04.02 -	ALT	- AC	6 PK 698
				ALT	+ AC	6 PK 1100
				PS		4 PK 755
				CAM		ZRK 1127



## CITROËN

### JUMPER Bus (244, Z\_)

#### 2.0

1998 ccm 81 kW XU10J2 04.02 - CAM KT 1522

#### 2.0 bivalent

1998 ccm 81 kW XU10J2 02.03 - ALT - AC 6 PK 698  
ALT + AC 6 PK 1100  
PS 4 PK 755  
CAM ZRK 1127  
CAM KT 1522

#### 2.0 HDi

1997 ccm 62 kW RHV (DW10UTD) 04.02 - ALT FROM: 05.04; MTR-CODE: DW10TD; - AC 6 PK 870  
ALT MTR-CODE: DW10TD; + AC 6 PK 1185  
ALT UNTIL: 05.04; MTR-CODE: DW10TD; - AC 6 PK 1470  
PS FROM CHA-NO.: 17431901; MTR-CODE: DW10TD 4 PK 755  
CAM MTR-CODE: DW10TD ZRK 1352  
CAM MTR-CODE: DW10TD KT 1327  
W-P; CAM KT 1327 W1

#### 2.2 HDi

2179 ccm 74 kW 4HY (DW12UTED4) 04.02 - ALT FROM: 05.04; MTR-CODE: DW12UTED; - AC 6 PK 870  
ALT MTR-CODE: DW12UTED; - AC 6 PK 1470  
ALT MTR-CODE: DW12UTED; + AC 6 PK 1185  
PS FROM CHA-NO.: 17431901; MTR-CODE: DW12UTED 4 PK 755  
PS MTR-CODE: DW12UTED 4 PK 755  
CAM MTR-CODE: DW12UTED ZRK 1456  
CAM FROM: 04.04; MTR-CODE: DW12UTED KT 1417  
CAM UNTIL: 04.04; MTR-CODE: DW12UTED KT 1353  
W-P; CAM FROM: 04.04 KT 1417 W1  
W-P; CAM UNTIL: 04.04 KT 1353 W1

#### 2.8 HDi

2798 ccm 94 kW 8140.43S 04.02 - AC-C MTR-CODE: F28TDCR 5 PK 1104  
ALT MTR-CODE: F28TDCR; + AUTO-TM 6 PK 995  
ALT MTR-CODE: F28TDCR; + MAN-TM 6 PK 950  
CAM ZRK 1312  
CAM KT 1229

### JUMPER Kasten (244)

#### 2.0

1998 ccm 81 kW XU10J2 04.02 - ALT - AC 6 PK 698  
ALT + AC 6 PK 1100  
PS 4 PK 755  
CAM ZRK 1127  
CAM KT 1522

#### 2.0 bivalent

1998 ccm 81 kW XU10J2 02.03 - ALT - AC 6 PK 698  
ALT + AC 6 PK 1100  
PS 4 PK 755  
CAM ZRK 1127  
CAM KT 1522

#### 2.0 HDi

1997 ccm 62 kW RHV (DW10TD);RHV (DW10UTD) 04.02 - ALT FROM: 05.04; MTR-CODE: DW10TD; - AC 6 PK 870  
ALT MTR-CODE: DW10TD; + AC 6 PK 1185  
ALT UNTIL: 05.04; MTR-CODE: DW10TD; - AC 6 PK 1470  
PS FROM CHA-NO.: 17431901; MTR-CODE: DW10TD 4 PK 755  
CAM MTR-CODE: DW10TD ZRK 1352  
CAM MTR-CODE: DW10TD KT 1327  
W-P; CAM KT 1327 W1

#### 2.2 HDi

2179 ccm 74 kW 4HY (DW12UTED4) 04.02 - ALT FROM: 05.04; MTR-CODE: DW12UTED; - AC 6 PK 870  
ALT MTR-CODE: DW12UTED; - AC 6 PK 1470  
ALT MTR-CODE: DW12UTED; + AC 6 PK 1185  
PS FROM CHA-NO.: 17431901; MTR-CODE: DW12UTED 4 PK 755  
PS MTR-CODE: DW12UTED 4 PK 755  
CAM MTR-CODE: DW12UTED ZRK 1456  
CAM FROM: 04.04; MTR-CODE: DW12UTED KT 1417



## CITROËN

### JUMPER Kasten (244)

2.2 HDi						
2179 ccm	74 kW	4HY (DW12UTED4)	04.02 -	CAM W-P; CAM W-P; CAM	UNTIL: 04.04; MTR-CODE: DW12UTED FROM: 04.04 UNTIL: 04.04	KT 1353 KT 1417 W1 KT 1353 W1
2.8 HDi						
2798 ccm	94 kW	8140.43S	04.02 -	AC-C ALT ALT CAM CAM	MTR-CODE: F28TDCR MTR-CODE: F28TDCR; + AUTO-TM MTR-CODE: F28TDCR; + MAN-TM	5 PK 1104 6 PK 995 6 PK 950 ZRK 1312 KT 1229
2.8 HDi 4x4						
2798 ccm	94 kW	8140.43S	04.02 -	AC-C ALT ALT CAM CAM	+ AUTO-TM + MAN-TM	5 PK 1104 6 PK 995 6 PK 950 ZRK 1312 KT 1229
2.8 HDi						
2798 ccm	107 kW	8140.43N	05.04 -	CAM		ZRK 1332

### JUMPER Pritsche/Fahrgestell (244)

2.0 HDi						
1997 ccm	62 kW	RHV (DW10UTD)	04.02 -	ALT ALT ALT PS  CAM CAM W-P; CAM	FROM: 05.04; MTR-CODE: DW10TD; - AC MTR-CODE: DW10TD; + AC UNTIL: 05.04; MTR-CODE: DW10TD; - AC FROM CHA-NO.: 17431901; MTR-CODE: DW10TD MTR-CODE: DW10TD MTR-CODE: DW10TD	6 PK 870 6 PK 1185 6 PK 1470 4 PK 755  ZRK 1352 KT 1327 KT 1327 W1
2.2 HDi 16V						
2179 ccm	74 kW	4HY (DW12UTED4)	04.02 -	ALT ALT PS CAM CAM CAM W-P; CAM W-P; CAM	- AC + AC  MTR-CODE: DW12UTED FROM: 04.04; MTR-CODE: DW12UTED UNTIL: 04.04; MTR-CODE: DW12UTED FROM: 04.04 UNTIL: 04.04	6 PK 1470 6 PK 1185 4 PK 755 ZRK 1456 KT 1417 KT 1353 KT 1417 W1 KT 1353 W1
2.2 HDi						
2179 ccm	74 kW	4HY (DW12UTED4)	02.02 -	ALT ALT ALT PS  CAM CAM CAM W-P; CAM W-P; CAM	FROM: 05.04; MTR-CODE: DW12UTED; - AC MTR-CODE: DW12UTED; + AC UNTIL: 05.04; MTR-CODE: DW12UTED; - AC FROM CHA-NO.: 17431901; MTR-CODE: DW12UTED MTR-CODE: DW12UTED FROM: 04.04; MTR-CODE: DW12UTED UNTIL: 04.04; MTR-CODE: DW12UTED MTR-CODE: DW12TED; FROM: 04.04 MTR-CODE: DW12TED; UNTIL: 04.04	6 PK 870 6 PK 1185 6 PK 1470 4 PK 755  ZRK 1456 KT 1417 KT 1353 KT 1417 W1 KT 1353 W1
2.8 HDi						
2798 ccm	94 kW	8140.43S	04.02 -	CAM CAM		ZRK 1312 KT 1229
2.8 HDi						
2800 ccm	107 kW	8140.43N	05.04 -	AC-C AC-C ALT ALT CAM	MTR-CODE: 814043N MTR-CODE: 814043S MTR-CODE: 814043N MTR-CODE: 814043S; + MAN-TM	5 PK 1104 5 PK 1104 6 PK 950 6 PK 950 ZRK 1332
2.8 HDi 4x4						
2798 ccm	94 kW	F28TDCR	02.02 -	AC-C ALT ALT CAM CAM	+ AUTO-TM + MAN-TM	5 PK 1104 6 PK 995 6 PK 950 ZRK 1312 KT 1229

### JUMPER Bus

2.2 HDi 100						
2198 ccm	74 kW	4HV (P22DTE)	04.06 -	ALT	- AC	6 EPK 873



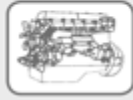

## CITROËN

### JUMPER Bus

#### 2.2 HDi 100

2198 ccm	74 kW	4HV (P22DTE)	04.06 -	ALT PS	MTR-CODE: 22DT; + AC	6 PK 1670 4 EPK 922
----------	-------	--------------	---------	-----------	----------------------	------------------------

#### 2.2 HDi 120

2198 ccm	88 kW	4HU (P22DTE)	04.06 -	ALT ALT PS	- AC MTR-CODE: 22DT; + AC	6 EPK 873 6 PK 1670 4 EPK 922
----------	-------	--------------	---------	------------------	------------------------------	-------------------------------------

#### 3.0 HDi 160

2999 ccm	116 kW	F1CE0481D (F30DT)	09.06 -	ALT	MTR-CODE: F30DT	6 PK 1165
----------	--------	-------------------	---------	-----	-----------------	-----------

### JUMPER Kasten

#### 2.2 HDi 100

2198 ccm	74 kW	4HV (P22DTE)	04.06 -	ALT ALT PS	- AC MTR-CODE: 22DT; + AC	6 EPK 873 6 PK 1670 4 EPK 922
----------	-------	--------------	---------	------------------	------------------------------	-------------------------------------

#### 2.2 HDi 120

2198 ccm	88 kW	4HU (P22DTE)	04.06 -	ALT ALT PS	- AC MTR-CODE: 22DT; + AC	6 EPK 873 6 PK 1670 4 EPK 922
----------	-------	--------------	---------	------------------	------------------------------	-------------------------------------

#### 3.0 HDi 160

2999 ccm	116 kW	F1CE0481D (F30DT)	09.06 -	AC-C ALT	MTR-CODE: F30DT	4 EPK 1102 6 PK 1165
----------	--------	-------------------	---------	-------------	-----------------	-------------------------

### JUMPER Pritsche/Fahrgestell

#### 2.2 HDi 100

2198 ccm	74 kW	4HV (P22DTE)	04.06 -	ALT ALT PS	- AC MTR-CODE: 22DT; + AC	6 EPK 873 6 PK 1670 4 EPK 922
----------	-------	--------------	---------	------------------	------------------------------	-------------------------------------

#### 2.2 HDi 120

2198 ccm	88 kW	4HU (P22DTE)	04.06 -	ALT ALT PS	- AC MTR-CODE: 22DT; + AC	6 EPK 873 6 PK 1670 4 EPK 922
----------	-------	--------------	---------	------------------	------------------------------	-------------------------------------

#### 3.0 HDi 160

2999 ccm	116 kW	F1CE0481D (F30DT)	09.06 -	AC-C ALT	MTR-CODE: F30DT	4 EPK 1102 6 PK 1165
----------	--------	-------------------	---------	-------------	-----------------	-------------------------

## DAIHATSU

### EXTOL Bus (S22\_, S23\_)

#### 1.3

1298 ccm	63 kW	K3-VE	07.00 -	AC-C		4 PK 705
----------	-------	-------	---------	------	--	----------

### HIJET Bus (S85)

#### 1.0 i

993 ccm	35 kW	CB42	07.94 -	ALT CAM		AVX 10 x 800 ZRK 1155
---------	-------	------	---------	------------	--	--------------------------

### HIJET Kasten (S85)

#### 1.0

993 ccm	33 kW	CB41	12.92 -	ALT CAM		AVX 10 x 800 ZRK 1155
---------	-------	------	---------	------------	--	--------------------------

## FIAT

### SCUDO Combinato (220P)

#### 1.6

1581 ccm	58 kW	220 A 2.000	02.96 - 12.06	PS AC-C ALT ALT CAM CAM	- AC + AC	AVX 10 x 690 6 PK 925 6 PK 894 4 PK 905 ZRK 1244 KT 1037
----------	-------	-------------	---------------	--	--------------	---

#### 2.0 16V

1997 ccm	100 kW	RFN	06.00 - 12.06	ALT ALT CAM CAM W-P; CAM	- AC + AC	6 PK 1190 6 PK 1710 ZRK 1149 KT 1244 KT 1244 W3
----------	--------	-----	---------------	--------------------------------------	--------------	---



## FIAT

### SCUDO Combinato (220P)

1.9 D						
1868 ccm	51 kW	WJZ (DW8)	04.98 - 12.06	ALT	FROM: 08.98; - AC; - PS	6 PK 865
				ALT	FROM: 08.98; MTR-CODE: DW8; + AC; + PS	6 PK 1735
				ALT	FROM: 08.98; MTR-CODE: WJY; - AC	6 PK 1440
				ALT	FROM: 08.98; OE-NO.: 96330104; + AC; - PS	6 PK 1045
				ALT	FROM: 08.98; UNTIL: 10.99; UNTIL ORGA-NO.: 8374; + PS; - AC	6 PK 1390
				ALT	FROM: 08.98; UNTIL: 12.02; MTR-CODE: WJY; UNTIL ORGA-NO.: 9520; + AC	6 PK 1735
				ALT	FROM: 10.99; MTR-CODE: DW8; FROM ORGA-NO.: 8375; + PS; - AC	6 PK 1440
				ALT	FROM: 12.02; MTR-CODE: WJY; FROM ORGA-NO.: 9521; + AC	6 PK 1675
				CAM		ZRK 1351
				CAM		KT 1433
				W-P; CAM		KT 1517 W1

1.9 D						
1905 ccm	51 kW	D9B	02.96 - 04.98	ALT	- AC; - PS	6 PK 730
				ALT	+ AC; - PS	6 PK 1165
				ALT	+ AC; + PS	6 PK 1740
				ALT	+ PS; - AC	6 PK 1115
				CAM		ZRK 1262
				CAM		KT 1040
				W-P; CAM	FROM: 04.97; FROM VET-NO.: 7391	KT 1040 W3
				W-P; CAM	UNTIL: 03.97; UNTIL VET-NO.: 7390	KT 1040 W1

1.9 TD Eco						
1905 ccm	66 kW	DHX (XUD9TF/L)	02.96 - 12.06	ALT	FROM: 05.97; - AC; - PS	6 PK 730
				ALT	FROM: 05.97; + AC; - PS	6 PK 1165
				ALT	FROM: 05.97; + AC; + PS	6 PK 1740
				ALT	FROM: 05.97; + PS; - AC	6 PK 1115
				CAM		ZRK 1262
				CAM		KT 1040
				W-P; CAM	FROM: 03.97; FROM VET-NO.: 7390	KT 1040 W3
				W-P; CAM	UNTIL: 03.97; UNTIL VET-NO.: 7390	KT 1040 W1

1.9 TD						
1905 ccm	68 kW	D8B	02.96 - 12.06	ALT	- AC; - PS	6 PK 730
				ALT	+ AC; - PS	6 PK 1165
				ALT	+ AC; + PS	6 PK 1740
				ALT	+ PS; - AC	6 PK 1115
				CAM		ZRK 1262
				CAM		KT 1040
				W-P; CAM	FROM: 04.97; FROM VET-NO.: 7391	KT 1040 W3
				W-P; CAM	UNTIL: 03.97; UNTIL VET-NO.: 7390	KT 1040 W1

2.0 JTD						
1997 ccm	69 kW	RHX	01.04 - 12.06	ALT	- AC	6 PK 1470
				ALT	FROM CHA-NO.: 0008983; + AC	6 PK 1740
				CAM		ZRK 1352
				CAM		KT 1518
				W-P; CAM		KT 1518 W1

2.0 JTD						
1997 ccm	80 kW	RHZ	12.99 - 12.06	ALT	- AC	6 PK 1470
				ALT	FROM: 06.01; FOR: SANDEN; + AC	6 PK 1740
				ALT	UNTIL: 06.01; UNTIL CHA-NO.: 0008982; FOR: DELPHI; + AC	5 PK 970
				CAM		ZRK 1352
				CAM	FROM: 04.00	KT 1518
				CAM	UNTIL: 04.00	KT 1327
				W-P; CAM	FROM: 04.00	KT 1518 W1
				W-P; CAM	UNTIL: 04.00	KT 1327 W1

2.0 JTD 16V						
1997 ccm	80 kW	RHW (DW10ATED4)	05.99 - 12.06	W-P; CAM	FROM: 04.04	KT 1480 W1

### SCUDO Kasten (220L)

1.6						
1581 ccm	58 kW	220 A 2.000	02.96 - 12.06	PS		AVX 10 x 685
				AC-C		6 PK 925
				ALT	- AC	6 PK 894
				ALT	+ AC	4 PK 905

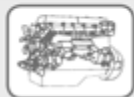

## FIAT

### SCUDO Kasten (220L)

<b>1.6</b>						
1581 ccm	58 kW	220 A 2.000	02.96 - 12.06	CAM CAM		ZRK 1244 KT 1037
<b>2.0</b>						
1997 ccm	100 kW	RFN	05.00 - 12.06	ALT ALT W-P; CAM	- AC + AC	6 PK 1190 6 PK 1710 KT 1244 W3
<b>1.9 D</b>						
1868 ccm	51 kW	WJZ (DW8)	04.98 - 12.06	ALT ALT ALT ALT ALT ALT ALT CAM CAM W-P; CAM	- AC; - PS FROM: 10.99; MTR-CODE: DW8;WJZ; FROM ORGA-NO.: 8375; + PS; - AC FROM: 12.02; MTR-CODE: WJY; FROM ORGA-NO.: 9521; + AC MTR-CODE: DW8;WJZ; + AC; + PS MTR-CODE: WJY; - AC OE-NO.: 96330104; + AC; - PS UNTIL: 10.99; UNTIL ORGA-NO.: 8374; + PS; - AC UNTIL: 12.02; MTR-CODE: WJY; UNTIL ORGA-NO.: 9520; + AC	6 PK 865 6 PK 1440 6 PK 1675 6 PK 1735 6 PK 1440 6 PK 1045 6 PK 1390 6 PK 1735 ZRK 1351 KT 1433 KT 1517 W1
<b>1.9 D</b>						
1905 ccm	51 kW	D9B	02.96 - 12.06	ALT ALT ALT ALT CAM CAM W-P; CAM W-P; CAM	- AC; - PS + AC; - PS + AC; + PS + PS; - AC	6 PK 730 6 PK 1165 6 PK 1740 6 PK 1115 ZRK 1262 KT 1040 KT 1040 W3 KT 1040 W1
<b>1.9 TD</b>						
1905 ccm	66 kW	DHX (XUD9TF/L)	02.96 - 12.06	ALT ALT ALT ALT CAM CAM W-P; CAM W-P; CAM	FROM: 04.98; - AC; - PS FROM: 04.98; + AC; - PS FROM: 04.98; + AC; + PS FROM: 04.98; + PS; - AC	6 PK 730 6 PK 1165 6 PK 1740 6 PK 1115 ZRK 1262 KT 1040 KT 1040 W3 KT 1040 W1
<b>1.9 TD</b>						
1905 ccm	68 kW	D8B	02.98 - 12.06	ALT ALT ALT ALT CAM CAM W-P; CAM	- AC; - PS + AC; - PS + AC; + PS + PS; - AC	6 PK 730 6 PK 1165 6 PK 1740 6 PK 1115 ZRK 1262 KT 1040 KT 1040 W3
<b>2.0 JTD</b>						
1997 ccm	69 kW	RHX	12.99 - 12.06	ALT ALT ALT ALT ALT ALT ALT CAM CAM CAM W-P; CAM W-P; CAM	FROM: 06.01; FROM CHA-NO.: 0008983; MTR-CODE: RHX; + AC FROM: 06.01; MTR-CODE: RHX;RHZ; FOR: SANDEN; + AC MTR-CODE: RHX; - AC MTR-CODE: RHX;RHZ; - AC UNTIL: 06.01; UNTIL CHA-NO.: 0008982; MTR-CODE: RHX; FOR: DELPHI; + AC UNTIL: 06.01; UNTIL CHA-NO.: 0008982; MTR-CODE: RHX; FOR: SANDEN; + AC UNTIL: 06.01; UNTIL CHA-NO.: 0008982; MTR-CODE: RHX;RHZ; FOR: DELPHI; + AC	6 PK 1740 6 PK 1740 6 PK 1470 6 PK 1470 5 PK 970 6 PK 1740 5 PK 970 ZRK 1352 KT 1518 KT 1327 KT 1518 W1 KT 1327 W1
<b>2.0 JTD</b>						
1997 ccm	80 kW	RHZ	12.02 - 12.06	ALT	- AC	6 PK 1470



## FIAT

### SCUDO Kasten (220L)

#### 2.0 JTD

1997 ccm	80 kW	RHZ	12.02 - 12.06	ALT	FROM CHA-NO.: 0008983; MTR-CODE: RHW; + AC	6 PK 1740
				ALT	MTR-CODE: RHM; + AC	6 PK 1740
				CAM		ZRK 1352
				CAM		KT 1518
				W-P; CAM		KT 1518 W1

#### 2.0 JTD 16V

1997 ccm	80 kW	RHW (DW10ATED4)	05.99 - 12.06	W-P; CAM	FROM: 04.04	KT 1480 W1
----------	-------	-----------------	---------------	----------	-------------	------------

### SCUDO (270\_)

#### 1.6 D Multijet

1560 ccm	66 kW	9HU	01.07 -	ALT	+ AC	6 PK 1710
				CAM		ZRK 1460
				CAM		KT 1390
				W-P; CAM	MTR-CODE: DV6UTED4	KT 1390 W1

#### 2.0 D Multijet

1997 ccm	88 kW	RHK	01.07 -	ALT		6 PK 1215
				CAM	MTR-CODE: DW10BTED4FAP	ZRK 1452
				CAM	MTR-CODE: DW10BTED4FAP	KT 1428
				W-P; CAM		KT 1428 W1

#### 2.0 D Multijet

1997 ccm	94 kW	RH02	04.11 -	CAM		ZRK 1592
----------	-------	------	---------	-----	--	----------

#### 2.0 D Multijet

1997 ccm	100 kW	RHR	01.07 -	ALT		6 PK 1215
				CAM	MTR-CODE: DW10BTED4FAP	ZRK 1452
				CAM	MTR-CODE: DW10BTED4FAP	KT 1428
				W-P; CAM		KT 1428 W1

### SCUDO Kasten (270\_)

#### 1.6 D Multijet

1560 ccm	66 kW	9HU	01.07 -	ALT	+ AC	6 PK 1710
				CAM		ZRK 1460
				CAM		KT 1390
				W-P; CAM	MTR-CODE: DV6UTED4	KT 1390 W1

#### 2.0 D Multijet

1997 ccm	88 kW	RHK	01.07 -	ALT		6 PK 1215
				CAM	MTR-CODE: DW10BTED4FAP	ZRK 1452
				CAM	MTR-CODE: DW10BTED4FAP	KT 1428
				W-P; CAM		KT 1428 W1

#### 2.0 D Multijet

1997 ccm	94 kW	RH02	05.11 -	CAM		ZRK 1592
----------	-------	------	---------	-----	--	----------

#### 2.0 D Multijet

1997 ccm	100 kW	RHR	01.07 -	ALT		6 PK 1215
				CAM	MTR-CODE: DW10BTED4FAP	ZRK 1452
				CAM	MTR-CODE: DW10BTED4FAP	KT 1428
				W-P; CAM		KT 1428 W1

### SCUDO Pritsche/Fahrgestell (270\_)

#### 1.6 D Multijet

1560 ccm	66 kW	9HU	01.07 -	ALT	+ AC	6 PK 1710
				CAM		ZRK 1460
				CAM		KT 1390
				W-P; CAM	MTR-CODE: DV6UTED4	KT 1390 W1

#### 2.0 D Multijet

1997 ccm	88 kW	RHK	01.07 -	ALT		6 PK 1215
				W-P; CAM		KT 1428 W1

#### 2.0 D Multijet

1997 ccm	100 kW	DW10BTED4;RHR	01.07 -	ALT		6 PK 1215
				W-P; CAM		KT 1428 W1

### DUCATO Bus (230)

#### 2.0

1998 ccm	74 kW		06.94 - 12.95	ALT	MOD: 10; - AC	6 PK 698
				ALT	MOD: 10; + AC	6 PK 1100

#### 2.0 Panorama/Combinato

1998 ccm	80 kW	RFW	03.94 - 04.02	PS		AVX 10 x 710
				PS	UNTIL: 12.96	AVX 10 x 715



## FIAT

### DUCATO Bus (230)

#### 2.0 Panorama/Combinato

1998 ccm	80 kW	RFW	03.94 - 04.02	ALT	MOD: 14; - AC	6 PK 698
				ALT	MOD: 14; + AC	6 PK 1100
				PS	FROM: 12.96; MOD: 14	4 PK 755
				CAM		ZRK 1127
				CAM		KT 1522

#### 2.0 4x4

1998 ccm	80 kW	RFW	11.94 - 11.01	ALT	MOD: 10; - AC	6 PK 698
				ALT	MOD: 10; + AC	6 PK 1100
				PS	FROM: 12.96; MOD: 10	4 PK 755
				CAM		ZRK 1127
				CAM		KT 1522

#### 1.9 D

1905 ccm	50 kW	D9B;D9B (XUD9A);DJY	04.98 - 04.02	PS		AVX 10 x 700
				ALT	MOD: 10; - AC	6 PK 730
				ALT	MTR-CODE: DHX;DJY; AMP: 120; MOD: 10; + AC	6 PK 1153
				ALT	MTR-CODE: DHX;DJY; AMP: 80; MOD: 10; + AC	6 PK 1145
				PS	MOD: 10	4 PK 755
				CAM		ZRK 1262
				CAM		KT 1040

#### 1.9 TD

1905 ccm	66 kW	DHX (XUD9TF/L)	04.98 - 04.02	ALT	AMP: 120; MOD: 14; + AC	6 PK 1153
				ALT	AMP: 80; MOD: 14; + AC	6 PK 1145
				ALT	MOD: 14; - AC	6 PK 730
				PS	MOD: 14	4 PK 755
				CAM		ZRK 1262
				CAM		KT 1040
				W-P; CAM		KT 1040 W3

#### 1.9 D Combinato

1929 ccm	51 kW	230 A2.000	06.95 - 04.02	PS		AVX 10 x 700
				AC-C	MOD: 10	5 PK 1055
				ALT	MOD: 10	5 PK 940
				CAM		ZRK 1254
				CAM		KT 1257

#### 1.9 TD Combinato

1929 ccm	59 kW	230 A4.000	08.94 - 04.02	PS		AVX 10 x 700
				AC-C	MTR-CODE: 230A3000;230A4000; MOD: 10; AWD	5 PK 1040
				AC-C	MTR-CODE: 230A3000;230A4000; MOD: 10; FWD	5 PK 1055
				AC-C	MTR-CODE: 230A3000;230A4000; MOD: 14	5 PK 1055
				ALT	MTR-CODE: 230A3000;230A4000; MOD: 10; - AC; - PS	5 PK 925
				ALT	MTR-CODE: 230A3000;230A4000; MOD: 10; + AC; + PS	6 PK 962
				ALT	MTR-CODE: 230A3000;230A4000; MOD: 10; + PS; - AC	5 PK 962
				ALT	MTR-CODE: 230A3000;230A4000; MOD: 14; - PS	5 PK 925
				ALT	MTR-CODE: 230A3000;230A4000; MOD: 14; + PS	5 PK 962
				CAM		ZRK 1254
				CAM		KT 1257

#### 1.9 TD Panorama/Combinato

1929 ccm	60 kW	230 A3.000	03.94 - 04.02	PS		AVX 10 x 700
				AC-C	MOD: 10; AWD	5 PK 1040
				AC-C	MOD: 10; FWD	5 PK 1055
				ALT	MOD: 10; - AC; - PS	5 PK 925
				ALT	MOD: 10; + AC; + PS	6 PK 962
				ALT	MOD: 10; + PS; - AC	5 PK 962
				CAM		ZRK 1254
				CAM		KT 1257

#### 2.0 JTD

1997 ccm	62 kW	RHV (DW10)	10.01 - 04.02	ALT	MOD: 11; + AC	6 PK 1185
				ALT	MOD: 18; - AC	6 PK 1470
				ALT	MOD: 18; + AC	6 PK 1185
				ALT	UNTIL CHA-NO.: 7431901; MOD: 11; - AC	6 PK 1470
				PS	MOD: 11	4 PK 755

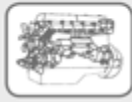

# FIAT

## DUCATO Bus (230)

2.0 JTD						
1997 ccm	62 kW	RHV (DW10)	10.01 - 04.02	PS CAM CAM W-P; CAM	MOD: 18	4 PK 755 ZRK 1352 KT 1327 KT 1327 W1
2.5 TD						
2499 ccm	80 kW	8140.47	06.94 - 08.98	AC-C AC-C AC-C AC-C AC-C AC-C ALT ALT CAM CAM	FROM MTR-NO: 2669696; MOD: 14; AWD FROM MTR-NO: 2669696; MOD: 18; AWD MOD: 14; FWD MOD: 18; FWD UNTIL MTR-NO: 2669395; MOD: 14; AWD UNTIL MTR-NO: 2669395; MOD: 18; AWD MOD: 14 MOD: 18	5 PK 1104 5 PK 1104 5 PK 1055 5 PK 1055 5 PK 1080 5 PK 1080 6 PK 894 6 PK 894 ZRK 1316 KT 1217
2.5 TD 4x4						
2499 ccm	80 kW	8140.47	11.94 - 04.98	AC-C AC-C AC-C ALT CAM CAM	FROM MTR-NO: 2669396; MOD: 10; AWD MOD: 10; FWD UNTIL MTR-NO: 2669395; MOD: 10; AWD MOD: 10	5 PK 1104 5 PK 1055 5 PK 1080 6 PK 894 ZRK 1316 KT 1217
2.5 D Combinato						
2500 ccm	62 kW	8140.67	08.94 - 04.02	VAC-P AC-C AC-C AC-C AC-C AC-C ALT ALT CAM CAM	FROM MTR-NO: 2669396; MOD: 10 FROM MTR-NO: 2669396; MOD: 18; AWD MOD: 18; FWD UNTIL MTR-NO: 2669395; MOD: 10 UNTIL MTR-NO: 2669395; MOD: 18; AWD MOD: 10 MOD: 18	AVX 10 x 600 5 PK 1104 5 PK 1104 5 PK 1055 5 PK 1080 5 PK 1080 6 PK 894 6 PK 894 ZRK 1312 KT 1229
2.5 TDI Panorama/Combinato						
2500 ccm	80 kW	8140.47R	07.94 - 04.02	VAC-P AC-C AC-C AC-C ALT CAM CAM	FROM MTR-NO: 2669696; MOD: 14; AWD MOD: 14; FWD UNTIL MTR-NO: 2669395; MOD: 14; AWD MOD: 14	AVX 10 x 600 5 PK 1104 5 PK 1055 5 PK 1080 6 PK 894 ZRK 1316 KT 1217
2.5 TDI Panorama/Combinato						
2500 ccm	85 kW	8140.47	03.94 - 04.02	VAC-P AC-C AC-C AC-C AC-C AC-C AC-C ALT ALT CAM CAM	FROM MTR-NO: 2669696; MOD: 14; AWD FROM MTR-NO: 2669696; MOD: 18; AWD MOD: 14; FWD MOD: 18; FWD UNTIL MTR-NO: 2669395; MOD: 14; AWD UNTIL MTR-NO: 2669395; MOD: 18; AWD MOD: 14 MOD: 18	AVX 10 x 600 5 PK 1104 5 PK 1104 5 PK 1055 5 PK 1055 5 PK 1080 5 PK 1080 6 PK 894 6 PK 894 ZRK 1316 KT 1217
2.5 TDI 4x4						
2500 ccm	85 kW	8140.47	04.97 - 04.02	AC-C AC-C AC-C ALT CAM CAM	FROM MTR-NO: 2669696; MOD: 18; AWD MOD: 18; FWD UNTIL MTR-NO: 2669395; MOD: 18; AWD MOD: 18	5 PK 1104 5 PK 1055 5 PK 1080 6 PK 894 ZRK 1316 KT 1217
2.8 D						
2800 ccm	64 kW	8140.63	02.98 - 04.02	PS AC-C AC-C AC-C AC-C	MOD: 14; AWD MOD: 14; FWD MOD: 18; AWD MOD: 18; FWD	AVX 10 x 700 5 PK 1104 5 PK 1055 5 PK 1104 5 PK 1055

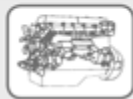

## FIAT

### DUCATO Bus (230)

#### 2.8 D

2800 ccm	64 kW	8140.63	02.98 - 04.02	ALT	FROM: 12.99; FROM MTR-NO: 2976899; MOD: 14	6 PK 950
				ALT	FROM: 12.99; FROM MTR-NO: 2976899; MOD: 18	6 PK 950
				ALT	UNTIL: 12.99; UNTIL MTR-NO: 2976898; MOD: 14	6 PK 913
				VAC-P	UNTIL: 12.99; UNTIL MTR-NO: 2976898; MOD: 18	6 PK 913
				CAM		ZRK 1316
				CAM		KT 1217

#### 2.8 TDI

2800 ccm	90 kW	8140.43	10.97 - 04.02	PS		AVX 10 x 700
				AC-C	FROM: 05.98; MOD: 18; AWD	5 PK 1104
				AC-C	FROM: 05.98; MOD: 18; FWD	5 PK 1055
				AC-C	FROM: 05.98; UNTIL MTR-NO: 2976898; MOD: 18	6 PK 913
				ALT	FROM: 05.98; FROM MTR-NO: 2976899; MOD: 18; AWD	6 PK 950
				CAM		ZRK 1332
				CAM		KT 1340

#### 2.8 TDI 4x4

2800 ccm	90 kW	8140.43	07.99 - 04.02	AC-C	MOD: 10; AWD	5 PK 1104
				AC-C	MOD: 10; FWD	5 PK 1055
				ALT	FROM: 01.00; FROM MTR-NO: 2976899; MOD: 10	6 PK 950
				ALT	UNTIL: 12.99; UNTIL MTR-NO: 2976898; MOD: 10	6 PK 913
				CAM		ZRK 1332
				CAM		KT 1340

#### 2.8 JTD

2798 ccm	94 kW	8140.43S	11.00 - 04.02	AC-C	MOD: 18	5 PK 1104
				ALT	+ AUTO-TM; MOD: 18	6 PK 995
				ALT	+ MAN-TM; MOD: 18	6 PK 950
				CAM		ZRK 1312
				CAM		KT 1229

#### 2.8 JTD 4x4

2798 ccm	94 kW	8140.43S	11.00 - 04.02	AC-C	MOD: 10; AWD	5 PK 1104
				AC-C	MOD: 10; FWD	5 PK 1055
				ALT	+ AUTO-TM; MOD: 10	6 PK 995
				ALT	+ MAN-TM; AMP: 120; MOD: 10	6 PK 950
				CAM		ZRK 1312
				CAM		KT 1229

### DUCATO Kasten (230L)

#### 2.0

1998 ccm	80 kW	RFW	03.94 - 04.02	PS	UNTIL: 12.96	AVX 10 x 715
				ALT	MOD: 10; - AC	6 PK 698
				ALT	MOD: 10; + AC	6 PK 1100
				PS	FROM: 12.96; MOD: 10	4 PK 755
				CAM		ZRK 1127
				CAM		KT 1522

#### 1.9 D

1905 ccm	50 kW	DJY	04.98 - 04.02	PS		AVX 10 x 700
				ALT	MOD: 10; - AC	6 PK 730
				ALT	MTR-CODE: DHX;DJY; AMP: 120; MOD: 10; + AC	6 PK 1153
				ALT	MTR-CODE: DHX;DJY; AMP: 80; MOD: 10; + AC	6 PK 1145
				PS	MOD: 10	4 PK 755
				CAM		ZRK 1262
				CAM		KT 1040

#### 1.9 TD

1905 ccm	66 kW	DHX (XUD9TF/L)	04.98 - 04.02	PS		AVX 10 x 700
				ALT	AMP: 120; MOD: 14; + AC	6 PK 1153
				ALT	AMP: 80; MOD: 14; + AC	6 PK 1145
				ALT	MOD: 14; - AC	6 PK 730
				PS	MOD: 14	4 PK 755
				CAM		ZRK 1262
				CAM		KT 1040





# FIAT

## DUCATO Kasten (230L)

<b>1.9 TD</b>						
1905 ccm	66 kW	DHX (XUD9TF/L)	04.98 - 04.02	W-P; CAM		<b>KT 1040 W3</b>
<b>1.9 D</b>						
1929 ccm	51 kW	230 A2.000	03.94 - 04.02	PS		<b>AVX 10 x 700</b>
				AC-C	FROM: 11.94; MOD: 10	<b>5 PK 1055</b>
				ALT	FROM: 11.94; MOD: 10	<b>5 PK 940</b>
				CAM		<b>ZRK 1254</b>
				CAM		<b>KT 1257</b>
<b>1.9 TD CAT</b>						
1929 ccm	59 kW	230 A4.000	08.94 - 04.02	AC-C	MTR-CODE: 230A3000;230A4000; MOD: 10; AWD	<b>5 PK 1040</b>
				AC-C	MTR-CODE: 230A3000;230A4000; MOD: 10; FWD	<b>5 PK 1055</b>
				AC-C	MTR-CODE: 230A3000;230A4000; MOD: 14	<b>5 PK 1055</b>
				ALT	MTR-CODE: 230A3000;230A4000; MOD: 10; - AC; - PS	<b>5 PK 925</b>
				ALT	MTR-CODE: 230A3000;230A4000; MOD: 10; + AC; + PS	<b>6 PK 962</b>
				ALT	MTR-CODE: 230A3000;230A4000; MOD: 10; + PS; - AC	<b>5 PK 962</b>
				ALT	MTR-CODE: 230A3000;230A4000; MOD: 14; - PS	<b>5 PK 925</b>
				ALT	MTR-CODE: 230A3000;230A4000; MOD: 14; + PS	<b>5 PK 962</b>
				CAM		<b>ZRK 1254</b>
				CAM		<b>KT 1257</b>
<b>1.9 TD</b>						
1929 ccm	60 kW	230 A3.000	03.94 - 04.02	PS		<b>AVX 10 x 700</b>
				AC-C	MTR-CODE: 230A3000;230A4000; MOD: 10; AWD	<b>5 PK 1040</b>
				AC-C	MTR-CODE: 230A3000;230A4000; MOD: 10; FWD	<b>5 PK 1055</b>
				AC-C	MTR-CODE: 230A3000;230A4000; MOD: 14	<b>5 PK 1055</b>
				ALT	MTR-CODE: 230A3000;230A4000; MOD: 10; - AC; - PS	<b>5 PK 925</b>
				ALT	MTR-CODE: 230A3000;230A4000; MOD: 10; + AC; + PS	<b>6 PK 962</b>
				ALT	MTR-CODE: 230A3000;230A4000; MOD: 10; + PS; - AC	<b>5 PK 962</b>
				ALT	MTR-CODE: 230A3000;230A4000; MOD: 14; - PS	<b>5 PK 925</b>
				ALT	MTR-CODE: 230A3000;230A4000; MOD: 14; + PS	<b>5 PK 962</b>
				CAM		<b>ZRK 1254</b>
				CAM		<b>KT 1257</b>
<b>2.0 JTD</b>						
1997 ccm	62 kW	RHV (DW10)	10.01 - 04.02	ALT	MOD: 11; + AC	<b>6 PK 1185</b>
				ALT	MOD: 18; - AC	<b>6 PK 1470</b>
				ALT	MOD: 18; + AC	<b>6 PK 1185</b>
				ALT	UNTIL CHA-NO.: 7431901; MOD: 11; - AC	<b>6 PK 1470</b>
				PS	MOD: 11	<b>4 PK 755</b>
				PS	MOD: 18	<b>4 PK 755</b>
				CAM		<b>ZRK 1352</b>
				CAM		<b>KT 1327</b>
				W-P; CAM		<b>KT 1327 W1</b>
<b>2.0 4x4</b>						
1998 ccm	80 kW	RFW	11.94 - 04.02	CAM		<b>ZRK 1127</b>
<b>2.5 TD</b>						
2499 ccm	80 kW	8140.47	06.94 - 08.98	AC-C	FROM MTR-NO: 2669696; MOD: 14; AWD	<b>5 PK 1104</b>
				AC-C	MOD: 14; FWD	<b>5 PK 1055</b>
				AC-C	UNTIL MTR-NO: 2669395; MOD: 14; AWD	<b>5 PK 1080</b>
				ALT	MOD: 14	<b>6 PK 894</b>
				CAM		<b>ZRK 1316</b>
				CAM		<b>KT 1217</b>
<b>2.5 TD 4x4</b>						
2499 ccm	80 kW	8140.47	11.94 - 04.98	CAM		<b>ZRK 1316</b>
				CAM		<b>KT 1217</b>
<b>2.5 D</b>						
2500 ccm	62 kW	8140.67	03.94 - 04.02	AC-C	FROM MTR-NO: 2669396; MOD: 10	<b>5 PK 1104</b>
				AC-C	UNTIL MTR-NO: 2669395; MOD: 10	<b>5 PK 1080</b>

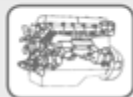

## FIAT

### DUCATO Kasten (230L)

#### 2.5 D

2500 ccm	62 kW	8140.67	03.94 - 04.02	ALT	MOD: 10	6 PK 894
				CAM		ZRK 1312
				CAM		KT 1229

#### 2.5 TDI

2500 ccm	80 kW	8140.47R	03.94 - 04.02	CAM		ZRK 1316
				CAM		KT 1217

#### 2.5 TDI

2500 ccm	85 kW	8140.47	03.94 - 04.02	AC-C	FROM MTR-NO: 2669696; MOD: 14; AWD	5 PK 1104
				AC-C	FROM MTR-NO: 2669696; MOD: 18; AWD	5 PK 1104
				AC-C	MOD: 14; FWD	5 PK 1055
				AC-C	MOD: 18; FWD	5 PK 1055
				AC-C	UNTIL MTR-NO: 2669395; MOD: 14; AWD	5 PK 1080
				AC-C	UNTIL MTR-NO: 2669395; MOD: 18; AWD	5 PK 1080
				ALT	MOD: 14	6 PK 894
				ALT	MOD: 18	6 PK 894
				CAM		ZRK 1316
				CAM		KT 1217

#### 2.5 TDI 4x4

2500 ccm	85 kW	8140.47	05.98 - 04.02	CAM		ZRK 1316
				CAM		KT 1217

#### 2.8 JTD

2798 ccm	94 kW	8140.43S	11.00 - 04.02	AC-C	FROM: 03.01; MOD: 18	5 PK 1104
				AC-C	MOD: 10; AWD	5 PK 1104
				AC-C	MOD: 10; FWD	5 PK 1055
				ALT	+ AUTO-TM; MOD: 10	6 PK 995
				ALT	+ MAN-TM; AMP: 120; MOD: 10	6 PK 950
				ALT	FROM: 03.01; + AUTO-TM; MOD: 18	6 PK 995
				ALT	FROM: 03.01; + MAN-TM; MOD: 18	6 PK 950
				CAM		ZRK 1312
				CAM		KT 1229

#### 2.8 JTD 4x4

2798 ccm	94 kW	8140.43S	11.00 - 04.02	AC-C	FROM: 03.01; MOD: 14	5 PK 1104
				AC-C	FROM: 03.01; MOD: 18	5 PK 1104
				ALT	FROM: 03.01; + AUTO-TM; MOD: 14	6 PK 995
				ALT	FROM: 03.01; + AUTO-TM; MOD: 18	6 PK 995
				ALT	FROM: 03.01; + MAN-TM; MOD: 18	6 PK 950
				ALT	FROM: 03.01; + MAN-TM; OE-NO.: 500385160; MOD: 14	6 PK 995
				ALT	FROM: 03.01; OE-NO.: 504171190; MOD: 14	6 PK 950
				CAM		ZRK 1312
				CAM		KT 1229

#### 2.8 D

2800 ccm	64 kW	8140.63	05.98 - 04.02	PS		AVX 10 x 700
				AC-C	MOD: 14; AWD	5 PK 1104
				AC-C	MOD: 14; FWD	5 PK 1055
				AC-C	MOD: 18; AWD	5 PK 1104
				AC-C	MOD: 18; FWD	5 PK 1055
				ALT	FROM: 12.99; FROM MTR-NO: 2976899; MOD: 14	6 PK 950
				ALT	FROM: 12.99; FROM MTR-NO: 2976899; MOD: 18	6 PK 950
				ALT	UNTIL: 12.99; UNTIL MTR-NO: 2976898; MOD: 14	6 PK 913
				VAC-P	UNTIL: 12.99; UNTIL MTR-NO: 2976898; MOD: 18	6 PK 913
				CAM		ZRK 1316
				CAM		KT 1217

#### 2.8 D 4x4

2800 ccm	64 kW	8140.63	08.98 - 04.02	AC-C	MOD: 14; AWD	5 PK 1104
				AC-C	MOD: 14; FWD	5 PK 1055
				ALT	FROM: 12.99; FROM MTR-NO: 2976899; MOD: 14	6 PK 950
				ALT	UNTIL: 12.99; UNTIL MTR-NO: 2976898; MOD: 14	6 PK 913
				CAM		ZRK 1316
				CAM		KT 1217

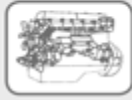

## FIAT

### DUCATO Kasten (230L)

2.8 TDI						
2800 ccm	90 kW	8140.43	10.97 - 04.02	PS		AVX 10 x 700
				AC-C	FROM: 05.98; MOD: 10; AWD	5 PK 1104
				AC-C	FROM: 05.98; MOD: 10; FWD	5 PK 1055
				AC-C	FROM: 05.98; MOD: 18; AWD	5 PK 1104
				AC-C	FROM: 05.98; MOD: 18; FWD	5 PK 1055
				AC-C	FROM: 05.98; UNTIL MTR-NO: 2976898; MOD: 18	6 PK 913
				ALT	FROM: 01.00; FROM MTR-NO: 2976899; MOD: 10	6 PK 950
				ALT	FROM: 05.98; FROM MTR-NO: 2976899; MOD: 18; AWD	6 PK 950
				VAC-P	FROM: 05.98; UNTIL: 12.99; UNTIL MTR-NO: 2976898; MOD: 10	6 PK 913
				CAM		ZRK 1332
				CAM		KT 1340

2.8 TDI 4x4						
2800 ccm	90 kW	8140.43	06.99 - 04.02	PS		AVX 10 x 700
				CAM		ZRK 1332
				CAM		KT 1340

### DUCATO Pritsche/Fahrgestell (230)

2.0						
1998 ccm	80 kW	RFW	06.98 - 04.02	PS		AVX 10 x 710
				ALT	MOD: 14; - AC	6 PK 698
				ALT	MOD: 14; + AC	6 PK 1100
				PS	MOD: 14	4 PK 755
				CAM		ZRK 1127
				CAM		KT 1522

1.9 D						
1905 ccm	50 kW	DJY	04.98 - 04.02	PS		AVX 10 x 700
				ALT	MOD: 10; - AC	6 PK 730
				ALT	MTR-CODE: DHX;DJY; AMP: 120; MOD: 10; + AC	6 PK 1153
				ALT	MTR-CODE: DHX;DJY; AMP: 80; MOD: 10; + AC	6 PK 1145
				PS	MOD: 10	4 PK 755
				CAM		ZRK 1262
				CAM		KT 1040

1.9 TD						
1905 ccm	66 kW	DHX (XUD9TF/L)	04.98 - 04.02	PS		AVX 10 x 700
				ALT	AMP: 120; MOD: 14; + AC	6 PK 1153
				ALT	AMP: 80; MOD: 14; + AC	6 PK 1145
				ALT	MOD: 14; - AC	6 PK 730
				PS	MOD: 14	4 PK 755
				CAM		ZRK 1262
				CAM		KT 1040
				W-P; CAM		KT 1040 W3

1.9 D						
1929 ccm	51 kW	230 A2.000	03.94 - 04.02	AC-C	FROM: 11.94; MOD: 10	5 PK 1055
				ALT	FROM: 11.94; MOD: 10	5 PK 940
				CAM		ZRK 1254
				CAM		KT 1257

1.9 TD CAT						
1929 ccm	59 kW	230 A4.000	08.94 - 04.02	AC-C	MTR-CODE: 230A3000;230A4000; MOD: 10; AWD	5 PK 1040
				AC-C	MTR-CODE: 230A3000;230A4000; MOD: 10; FWD	5 PK 1055
				AC-C	MTR-CODE: 230A3000;230A4000; MOD: 14	5 PK 1055
				ALT	MTR-CODE: 230A3000;230A4000; MOD: 10; - AC; - PS	5 PK 925
				ALT	MTR-CODE: 230A3000;230A4000; MOD: 10; + AC; + PS	6 PK 962
				ALT	MTR-CODE: 230A3000;230A4000; MOD: 10; + PS; - AC	5 PK 962
				ALT	MTR-CODE: 230A3000;230A4000; MOD: 14; - PS	5 PK 925
				ALT	MTR-CODE: 230A3000;230A4000; MOD: 14; + PS	5 PK 962
				CAM		ZRK 1254
				CAM		KT 1257



## FIAT

### DUCATO Pritsche/Fahrgestell (230)

#### 1.9 TD

1929 ccm	60 kW	230 A3.000	03.94 - 04.02	AC-C	MTR-CODE: 230A3000;230A4000; MOD: 10; AWD	5 PK 1040
				AC-C	MTR-CODE: 230A3000;230A4000; MOD: 10; FWD	5 PK 1055
				AC-C	MTR-CODE: 230A3000;230A4000; MOD: 14	5 PK 1055
				ALT	MTR-CODE: 230A3000;230A4000; MOD: 10; - AC; - PS	5 PK 925
				ALT	MTR-CODE: 230A3000;230A4000; MOD: 10; + AC; + PS	6 PK 962
				ALT	MTR-CODE: 230A3000;230A4000; MOD: 10; + PS; - AC	5 PK 962
				ALT	MTR-CODE: 230A3000;230A4000; MOD: 14; - PS	5 PK 925
				ALT	MTR-CODE: 230A3000;230A4000; MOD: 14; + PS	5 PK 962
				CAM		ZRK 1254
				CAM		KT 1257

#### 2.5 D 4x4

2500 ccm	62 kW	8140.67	03.94 - 04.02	AC-C	FROM MTR-NO: 2669396; MOD: 14	5 PK 1104
				AC-C	UNTIL MTR-NO: 2669395; MOD: 14	5 PK 1080
				ALT	MOD: 14	6 PK 894
				CAM		ZRK 1312
				CAM		KT 1229

#### 2.5 TD 4x4

2499 ccm	85 kW	8140.47	11.94 - 04.98	AC-C	FROM MTR-NO: 2669696; MOD: 14; AWD	5 PK 1104
				AC-C	MOD: 14; FWD	5 PK 1055
				AC-C	UNTIL MTR-NO: 2669395; MOD: 14; AWD	5 PK 1080
				ALT	MOD: 14	6 PK 894
				CAM		ZRK 1316
				CAM		KT 1217

#### 2.5 TD

2499 ccm	80 kW	8140.47	06.94 - 08.98	AC-C	FROM MTR-NO: 2669696; MOD: 14; AWD	5 PK 1104
				AC-C	MOD: 14; FWD	5 PK 1055
				AC-C	UNTIL MTR-NO: 2669395; MOD: 14; AWD	5 PK 1080
				ALT	MOD: 14	6 PK 894
				CAM		ZRK 1316
				CAM		KT 1217

#### 2.5 TD

2499 ccm	85 kW	8140.47	06.94 - 04.98	AC-C	FROM MTR-NO: 2669696; MOD: 14; AWD	5 PK 1104
				AC-C	MOD: 14; FWD	5 PK 1055
				AC-C	UNTIL MTR-NO: 2669395; MOD: 14; AWD	5 PK 1080
				ALT	MOD: 14	6 PK 894
				CAM		ZRK 1316
				CAM		KT 1217

#### 2.5 D

2500 ccm	62 kW	8140.67	03.94 - 04.02	AC-C	FROM MTR-NO: 2669396; MOD: 18; AWD	5 PK 1104
				AC-C	MOD: 18; FWD	5 PK 1055
				AC-C	UNTIL MTR-NO: 2669395; MOD: 18; AWD	5 PK 1080
				ALT	MOD: 18	6 PK 894
				CAM		ZRK 1312
				CAM		KT 1229

#### 2.5 TDI

2500 ccm	80 kW	8140.47R	03.94 - 04.02	AC-C	FROM MTR-NO: 2669696; MOD: 14; AWD	5 PK 1104
				AC-C	FROM MTR-NO: 2669696; MOD: 18; AWD	5 PK 1104
				AC-C	MOD: 14; FWD	5 PK 1055
				AC-C	MOD: 18; FWD	5 PK 1055
				AC-C	UNTIL MTR-NO: 2669395; MOD: 14; AWD	5 PK 1080
				AC-C	UNTIL MTR-NO: 2669395; MOD: 18; AWD	5 PK 1080
				ALT	MOD: 14	6 PK 894
				ALT	MOD: 18	6 PK 894
				CAM		ZRK 1316
				CAM		KT 1217

#### 2.5 TDI

2500 ccm	85 kW	8140.47	03.94 - 04.02	AC-C	FROM MTR-NO: 2669696; MOD: 14; AWD	5 PK 1104
				AC-C	MOD: 14; FWD	5 PK 1055
				AC-C	UNTIL MTR-NO: 2669395; MOD: 14; AWD	5 PK 1080
				ALT	MOD: 14	6 PK 894



## FIAT

### DUCATO Pritsche/Fahrgestell (230)

<b>2.5 TDI</b>						
2500 ccm	85 kW	8140.47	03.94 - 04.02	CAM		ZRK 1316
				CAM		KT 1217
<b>2.5 TDI 4x4</b>						
2500 ccm	85 kW	8140.47	06.98 - 04.02	AC-C	FROM MTR-NO: 2669696; MOD: 14; AWD	5 PK 1104
				AC-C	MOD: 14; FWD	5 PK 1055
				AC-C	UNTIL MTR-NO: 2669395; MOD: 14; AWD	5 PK 1080
				ALT	MOD: 14	6 PK 894
				CAM		ZRK 1316
				CAM		KT 1217
<b>2.8 JTD</b>						
2798 ccm	94 kW	8140.43S	11.00 - 04.02	AC-C	FROM: 03.01; MOD: 14	5 PK 1104
				AC-C	MOD: 18	5 PK 1104
				ALT	+ AUTO-TM; MOD: 18	6 PK 995
				ALT	+ MAN-TM; MOD: 18	6 PK 950
				ALT	FROM: 03.01; + AUTO-TM; MOD: 14	6 PK 995
				ALT	FROM: 03.01; + MAN-TM; OE-NO.: 500385160; MOD: 14	6 PK 995
				ALT	FROM: 03.01; OE-NO.: 504171190; MOD: 14	6 PK 950
				CAM		ZRK 1312
				CAM		KT 1229
<b>2.8 iDTD 4x4</b>						
2799 ccm	90 kW	8140.43	05.98 - 09.01	AC-C	MOD: 14	5 PK 1104
				AC-C	MOD: 18; AWD	5 PK 1104
				AC-C	MOD: 18; FWD	5 PK 1055
				ALT	FROM MTR-NO: 2976899; MOD: 14	6 PK 950
				ALT	FROM MTR-NO: 2976899; MOD: 18; AWD	6 PK 950
				ALT	UNTIL MTR-NO: 2976898; MOD: 18	6 PK 913
				ALT	UNTIL: 12.99; UNTIL MTR-NO: 2976898; MOD: 14	6 PK 913
<b>2.8 D</b>						
2800 ccm	64 kW	8140.63	02.98 - 04.02	PS		AVX 10 x 700
				AC-C	MOD: 14; AWD	5 PK 1104
				AC-C	MOD: 14; FWD	5 PK 1055
				AC-C	MOD: 18; AWD	5 PK 1104
				AC-C	MOD: 18; FWD	5 PK 1055
				ALT	FROM: 12.99; FROM MTR-NO: 2976899; MOD: 14	6 PK 950
				ALT	FROM: 12.99; FROM MTR-NO: 2976899; MOD: 18	6 PK 950
				ALT	UNTIL: 12.99; UNTIL MTR-NO: 2976898; MOD: 14	6 PK 913
				VAC-P	UNTIL: 12.99; UNTIL MTR-NO: 2976898; MOD: 18	6 PK 913
				CAM		ZRK 1316
				CAM		KT 1217
<b>2.8 TDI</b>						
2800 ccm	90 kW	8140.43	12.98 - 04.02	PS		AVX 10 x 700
				AC-C	MOD: 18; AWD	5 PK 1104
				AC-C	MOD: 18; FWD	5 PK 1055
				ALT	FROM MTR-NO: 2976899; MOD: 18; AWD	6 PK 950
				ALT	UNTIL MTR-NO: 2976898; MOD: 18	6 PK 913
				CAM		ZRK 1332
				CAM		KT 1340

### DUCATO Bus (244, Z\_)

<b>2.0</b>						
1998 ccm	81 kW	RFL	04.02 -	ALT	MOD: 11; - AC	6 PK 698
				ALT	MOD: 11; + AC	6 PK 1100
				ALT	MOD: 15; - AC	6 PK 698
				ALT	MOD: 15; + AC	6 PK 1100
				ALT	MOD: 18; - AC	6 PK 698
				ALT	MOD: 18; + AC	6 PK 1100
				PS	MOD: 11	4 PK 755
				PS	MOD: 15	4 PK 755
				PS	MOD: 18	4 PK 755
				CAM		ZRK 1127
				CAM		KT 1522

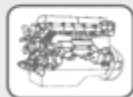

## FIAT

### DUCATO Bus (244, Z\_)

#### 2.0 4x4

1998 ccm	81 kW	RFL	05.02 -	ALT	MTR-CODE: RFL; MOD: 15; - AC	6 PK 698
				ALT	MTR-CODE: RFL; MOD: 15; + AC	6 PK 1100
				ALT	MTR-CODE: RFL; MOD: 18; - AC	6 PK 698
				ALT	MTR-CODE: RFL; MOD: 18; + AC	6 PK 1100
				PS	MTR-CODE: RFL; MOD: 15	4 PK 755
				PS	MTR-CODE: RFL; MOD: 18	4 PK 755

#### 2.0 Bipower

1998 ccm	81 kW	RFL	11.02 -	ALT	MOD: 15; - AC	6 PK 698
				ALT	MOD: 15; + AC	6 PK 1100
				PS	MOD: 15	4 PK 755
				CAM		ZRK 1127
				CAM		KT 1522

#### 2.0 JTD

1997 ccm	62 kW	RHV (DW10)	04.02 -	ALT	FROM: 05.04; FROM CHA-NO.: 7431902; MOD: 15; - AC	6 PK 870
				ALT	MOD: 15; + AC	6 PK 1185
				ALT	UNTIL: 05.04; UNTIL CHA-NO.: 7431901; MOD: 15; - AC	6 PK 1470
				PS	MOD: 15	4 PK 755
				CAM		ZRK 1352
				CAM		KT 1327
				W-P; CAM		KT 1327 W1

#### 2.3 JTD

2286 ccm	81 kW	F1AE0481C	04.02 -	AC-C	FROM MTR-NO: 0113089	4 EPK 903
				AC-C	UNTIL MTR-NO: 0113089; MOD: 11	4 PK 985
				AC-C	UNTIL MTR-NO: 0113089; MOD: 15	4 PK 985
				AC-C	UNTIL MTR-NO: 0113089; MOD: 18	4 PK 985
				ALT	MOD: 11	7 PK 1080
				ALT	MOD: 15	7 PK 1080
				ALT	MOD: 18	7 PK 1080
				CAM		ZRK 1596
				CAM		KT 1527

#### 2.8 JTD

2798 ccm	94 kW	8140.43S	04.02 -	AC-C	MOD: 11	5 PK 1104
				AC-C	MOD: 18	5 PK 1104
				ALT	+ AUTO-TM; MOD: 11	6 PK 995
				ALT	+ AUTO-TM; MOD: 18	6 PK 995
				ALT	+ MAN-TM; MOD: 11	6 PK 950
				ALT	+ MAN-TM; MOD: 18	6 PK 950
				CAM		ZRK 1312
				CAM		KT 1229

#### 2.8 JTD 4x4

2798 ccm	94 kW	8140.43S	07.02 -	AC-C	MOD: 18	5 PK 1104
				ALT	+ AUTO-TM; MOD: 18	6 PK 995
				ALT	+ MAN-TM; MOD: 18	6 PK 950
				CAM		ZRK 1312
				CAM		KT 1229

#### 2.8 JTD

2799 ccm	107 kW	8140.43N	04.04 -	AC-C	MOD: 18	5 PK 1104
				ALT	+ AUTO-TM; MOD: 18	6 PK 995
				ALT	+ MAN-TM; MOD: 18	6 PK 950
				CAM		ZRK 1312
				CAM		KT 1229

### DUCATO Kasten (244)

#### 2.0

1998 ccm	81 kW	RFL	04.02 -	ALT	MOD: 11; - AC	6 PK 698
				ALT	MOD: 11; + AC	6 PK 1100
				ALT	MOD: 15; - AC	6 PK 698
				ALT	MOD: 15; + AC	6 PK 1100
				ALT	MOD: 18; - AC	6 PK 698
				ALT	MOD: 18; + AC	6 PK 1100
				PS	MOD: 11	4 PK 755
				PS	MOD: 15	4 PK 755
				PS	MOD: 18	4 PK 755
				CAM		ZRK 1127
				CAM		KT 1522



## FIAT

### DUCATO Kasten (244)

#### 2.0 Bipower

1998 ccm	81 kW	RFL	11.02 -	ALT	MOD: 15; - AC	6 PK 698
				ALT	MOD: 15; + AC	6 PK 1100
				PS	MOD: 15	4 PK 755
				CAM		KT 1522

#### 2.0 JTD

1997 ccm	62 kW	RHV (DW10)	04.02 -	ALT	FROM: 05.04; FROM CHA-NO.: 7431902; MOD: 11; - AC	6 PK 870
				ALT	FROM: 05.04; FROM CHA-NO.: 7431902; MOD: 15; - AC	6 PK 870
				ALT	MOD: 11; + AC	6 PK 1185
				ALT	MOD: 15; + AC	6 PK 1185
				ALT	UNTIL: 05.04; UNTIL CHA-NO.: 7431901; MOD: 11; - AC	6 PK 1470
				ALT	UNTIL: 05.04; UNTIL CHA-NO.: 7431901; MOD: 15; - AC	6 PK 1470
				PS	MOD: 11	4 PK 755
				PS	MOD: 15	4 PK 755
				CAM		ZRK 1352
				CAM		KT 1327
				W-P; CAM		KT 1327 W1

#### 2.3 JTD

2286 ccm	81 kW	F1AE0481C	04.02 -	AC-C	FROM MTR-NO: 0113089	4 EPK 903
				AC-C	UNTIL MTR-NO: 0113089; MOD: 11	4 PK 985
				AC-C	UNTIL MTR-NO: 0113089; MOD: 15	4 PK 985
				AC-C	UNTIL MTR-NO: 0113089; MOD: 18	4 PK 985
				ALT	MOD: 11	7 PK 1080
				ALT	MOD: 15	7 PK 1080
				ALT	MOD: 18	7 PK 1080
				CAM		ZRK 1596
				CAM		KT 1527

#### 2.8 JTD

2798 ccm	94 kW	8140.43S	04.02 -	AC-C	MOD: 11	5 PK 1104
				AC-C	MOD: 15	5 PK 1104
				AC-C	MOD: 18	5 PK 1104
				ALT	+ AUTO-TM; MOD: 11	6 PK 995
				ALT	+ AUTO-TM; MOD: 15	6 PK 995
				ALT	+ AUTO-TM; MOD: 18	6 PK 995
				ALT	+ MAN-TM; MOD: 11	6 PK 950
				ALT	+ MAN-TM; MOD: 15	6 PK 950
				ALT	+ MAN-TM; MOD: 18	6 PK 950
				CAM		ZRK 1312
				CAM		KT 1229

#### 2.8 JTD 4x4

2798 ccm	94 kW	8140.43S	07.02 -	AC-C	MOD: 15	5 PK 1104
				AC-C	MOD: 18	5 PK 1104
				ALT	+ AUTO-TM; MOD: 15	6 PK 995
				ALT	+ AUTO-TM; MOD: 18	6 PK 995
				ALT	+ MAN-TM; MOD: 15	6 PK 950
				ALT	+ MAN-TM; MOD: 18	6 PK 950
				CAM		ZRK 1312
				CAM		KT 1229

#### 2.8 JTD Power

2800 ccm	107 kW	8140.43N	05.04 -	AC-C	MTR-CODE: 814043N; MOD: 15	5 PK 1104
				AC-C	MTR-CODE: 814043S; MOD: 18	5 PK 1104
				ALT	MTR-CODE: 814043N; + AUTO-TM; MOD: 15	6 PK 995
				ALT	MTR-CODE: 814043N; + MAN-TM; MOD: 15	6 PK 950
				ALT	MTR-CODE: 814043S; + AUTO-TM; MOD: 18	6 PK 995
				ALT	MTR-CODE: 814043S; + MAN-TM; MOD: 18	6 PK 950
				CAM		ZRK 1312
				CAM		KT 1229

### DUCATO Pritsche/Fahrgestell (244)

#### 2.0 JTD

1997 ccm	62 kW	RHV (DW10)	04.02 -	ALT	FROM: 05.04; FROM CHA-NO.: 7431902; MOD: 15; - AC	6 PK 870
				ALT	MOD: 15; + AC	6 PK 1185
				ALT	UNTIL: 05.04; UNTIL CHA-NO.: 7431901; MOD: 15; - AC	6 PK 1470



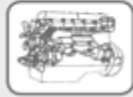

## FIAT

### DUCATO Pritsche/Fahrgestell (244)

#### 2.0 JTD

1997 ccm	62 kW	RHV (DW10)	04.02 -	PS CAM CAM W-P; CAM	MOD: 15	4 PK 755 ZRK 1352 KT 1327 KT 1327 W1
----------	-------	------------	---------	------------------------------	---------	---

#### 2.3 JTD

2286 ccm	81 kW	F1AE0481C	04.02 -	AC-C AC-C AC-C ALT ALT CAM CAM	FROM MTR-NO: 0113089 UNTIL MTR-NO: 0113089; MOD: 15 UNTIL MTR-NO: 0113089; MOD: 18 MOD: 15 MOD: 18	4 EPK 903 4 PK 985 4 PK 985 7 PK 1080 7 PK 1080 ZRK 1596 KT 1527
----------	-------	-----------	---------	--	--	--

#### 2.8 JTD

2798 ccm	94 kW	8140.43S	04.02 -	AC-C AC-C ALT ALT ALT ALT CAM CAM	MOD: 15 MOD: 18 + AUTO-TM; MOD: 15 + AUTO-TM; MOD: 18 + MAN-TM; MOD: 15 + MAN-TM; MOD: 18	5 PK 1104 5 PK 1104 6 PK 995 6 PK 995 6 PK 950 6 PK 950 ZRK 1312 KT 1229
----------	-------	----------	---------	--	--	---

#### 2.8 JTD 4x4

2798 ccm	94 kW	8140.43S	10.02 -	AC-C AC-C ALT ALT ALT ALT CAM CAM	MOD: 15 MOD: 18 + AUTO-TM; MOD: 15 + AUTO-TM; MOD: 18 + MAN-TM; MOD: 15 + MAN-TM; MOD: 18	5 PK 1104 5 PK 1104 6 PK 995 6 PK 995 6 PK 950 6 PK 950 ZRK 1312 KT 1229
----------	-------	----------	---------	--	--	---

#### 2.8 JTD Power

2800 ccm	107 kW	8140.43N	05.04 -	CAM CAM		ZRK 1312 KT 1229
----------	--------	----------	---------	------------	--	---------------------

### DUCATO Bus (250)

#### 140 Natural Power

2999 ccm	100 kW	F1CE0441A	04.09 -	ALT	MOD: 35	6 PK 1165
----------	--------	-----------	---------	-----	---------	-----------

#### 100 Multijet 2,2 D

2198 ccm	74 kW	4HV	07.06 -	ALT ALT ALT PS	- AC MOD: 30; + AC MOD: 33; + AC	6 EPK 873 6 PK 1670 6 PK 1670 4 EPK 922
----------	-------	-----	---------	-------------------------	--	--

#### 115 Multijet 2,0 D

1956 ccm	85 kW	250 A1.000	06.11 -	W-P; CAM		KT 1525 W1
----------	-------	------------	---------	----------	--	------------

#### 120 Multijet 2,3 D

2287 ccm	88 kW	F1AE0481D	07.06 -	AC-C ALT ALT CAM CAM	MOD: 30 MOD: 33	4 EPK 903 7 PK 1080 7 PK 1080 ZRK 1596 KT 1527
----------	-------	-----------	---------	----------------------------------	--------------------	--

#### 160 Multijet 3,0 D

2999 ccm	116 kW	F1CE0481D;F1CE3481M	07.06 -	AC-C ALT ALT	MTR-CODE: F1ACE0481D; MOD: 30 MTR-CODE: F1ACE0481D; MOD: 33	4 EPK 1102 6 PK 1165 6 PK 1165
----------	--------	---------------------	---------	--------------------	--	--------------------------------------

### DUCATO Kasten (250)

#### 100 Multijet 2,2 D

2198 ccm	74 kW	4HV	07.06 -	ALT ALT ALT PS	- AC MOD: 30; + AC MOD: 33; + AC	6 EPK 873 6 PK 1670 6 PK 1670 4 EPK 922
----------	-------	-----	---------	-------------------------	--	--

#### 115 Multijet 2,0 D

1956 ccm	85 kW	250 A1.000	06.11 -	W-P; CAM		KT 1525 W1
----------	-------	------------	---------	----------	--	------------

#### 120 Multijet 2,3 D

2287 ccm	88 kW	F1AE0481D	07.06 -	AC-C ALT	MOD: 30	4 EPK 903 7 PK 1080
----------	-------	-----------	---------	-------------	---------	------------------------



## FIAT

### DUCATO Kasten (250)

#### 120 Multijet 2,3 D

2287 ccm	88 kW	F1AE0481D	07.06 -	ALT	MOD: 33	7 PK 1080
				ALT	MOD: 35	7 PK 1080
				ALT	MOD: 40	7 PK 1080
				CAM		ZRK 1596
				CAM		KT 1527

#### 130 Multijet 2,3 D

2287 ccm	96 kW	F1AE0481N;F1AE3481D	01.07 -	ALT	MTR-CODE: F1AE0481N; MOD: 30	7 PK 1080
				ALT	MTR-CODE: F1AE0481N; MOD: 33	7 PK 1080
				ALT	MTR-CODE: F1AE0481N; MOD: 35	7 PK 1080

#### 160 Multijet 3,0 D

2999 ccm	116 kW	F1CE0481D	07.06 -	AC-C		4 EPK 1102
				ALT	MTR-CODE: F1ACE0481D; MOD: 30	6 PK 1165
				ALT	MTR-CODE: F1ACE0481D; MOD: 33	6 PK 1165
				ALT	MTR-CODE: F1ACE0481D; MOD: 35	6 PK 1165

### DUCATO Pritsche/Fahrgestell (250)

#### 100 Multijet 2,2 D

2198 ccm	74 kW	4HV	07.06 -	ALT	- AC	6 EPK 873
				ALT	MOD: 33; + AC	6 PK 1670
				ALT	MOD: 35; + AC	6 PK 1670
				PS		4 EPK 922

#### 115 Multijet 2,0 D

1956 ccm	85 kW	250 A1.000	06.11 -	W-P; CAM		KT 1525 W1
----------	-------	------------	---------	----------	--	------------

#### 120 Multijet 2,3 D

2287 ccm	88 kW	F1AE0481D	07.06 -	AC-C		4 EPK 903
				ALT	MOD: 33	7 PK 1080
				ALT	MOD: 35	7 PK 1080
				ALT	MOD: 40	7 PK 1080
				CAM		ZRK 1596
				CAM		KT 1527

#### 130 Multijet 2,3 D

2287 ccm	96 kW	F1AE0481N;F1AE3481D	01.07 -	ALT	MTR-CODE: F1AE0481N; MOD: 30	7 PK 1080
				ALT	MTR-CODE: F1AE0481N; MOD: 33	7 PK 1080
				ALT	MTR-CODE: F1AE0481N; MOD: 35	7 PK 1080

#### 160 Multijet 3,0 D

2999 ccm	116 kW	F1CE0481D	07.06 -	AC-C		4 EPK 1102
				ALT	MTR-CODE: F1ACE0481D; MOD: 33	6 PK 1165
				ALT	MTR-CODE: F1ACE0481D; MOD: 35	6 PK 1165
				ALT	MTR-CODE: F1ACE0481D; MOD: 40	6 PK 1165

## FORD

### TOURNEO CONNECT

#### 1.8 16V

1796 ccm	85 kW	EYPA;EYPC;EYPD	06.02 -	ALT	FROM: 08.05; MTR-CODE: ZH18EYPD; - AC	6 PK 1975
				ALT	FROM: 08.05; MTR-CODE: ZH18EYPD; + AC	6 PK 2100
				ALT	MTR-CODE: ZH18EYPA;ZH18EYPB; - AC	6 PK 1975
				ALT	MTR-CODE: ZH18EYPA;ZH18EYPB; + AC	6 PK 2100
				CAM		ZRK 1184
				CAM		KT 1440

#### 1.8 Di

1753 ccm	55 kW	BHPA;P7PA;P7PB;R2PA	06.02 -	ALT	FROM: 05.03; - AC	6 PK 1460
				ALT	FROM: 05.07; + AC	6 PK 1748
				ALT	UNTIL: 05.03; - AC	6 PK 1420
				ALT	UNTIL: 05.07; + AC	6 PK 1718
				INJ-P		ZRK 1353
				INJ-P	AU	KT 1319

#### 1.8 Turbo Di

1753 ccm	66 kW	HCPA;HCPB;P9PA;P9PB;P9PC;P9PD;R3PA;RWPE;RWPF	06.02 -	ALT	FROM: 05.03; - AC	6 PK 1460
				ALT	FROM: 05.07; + AC	6 PK 1748
				ALT	UNTIL: 05.03; - AC	6 PK 1420
				ALT	UNTIL: 05.07; + AC	6 PK 1718
				INJ-P		ZRK 1353
				INJ-P	AU	KT 1319

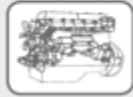

## FORD

### TOURNEO CONNECT

#### 1.8 TDCi

1753 ccm	81 kW	RWPA;RWPC;RWPD	08.06 -	ALT	- AC	6 PK 1460
				ALT	FROM: 05.07; + AC	6 PK 1748
				ALT	UNTIL: 05.07; + AC	6 PK 1718
				CAM		ZRK 1353
				CAM		KT 1319

### TRANSIT CONNECT (P65\_, P70\_, P80\_)

#### 1.8 16V

1796 ccm	85 kW	EYPA;EYPC;EYPD	06.02 -	ALT	- AC	6 PK 1975
				ALT	+ AC	6 PK 2100
				CAM		ZRK 1184
				CAM		KT 1440

#### 1.8 Di

1753 ccm	55 kW	BHPA;P7PA;P7PB;R2PA	06.02 -	ALT	FROM: 05.03; - AC	6 PK 1460
				ALT	FROM: 05.07; + AC	6 PK 1748
				ALT	UNTIL: 05.03; - AC	6 PK 1420
				ALT	UNTIL: 05.07; + AC	6 PK 1718
				INJ-P		ZRK 1353
				INJ-P	AU	KT 1319

#### 1.8 TDCi

1753 ccm	66 kW	HCPA;HCPB;P9PA;P9PB;P9PC; P9PD;R3PA;RWPE;RWPF	06.02 -	ALT	FROM: 05.03; - AC	6 PK 1460
				ALT	FROM: 05.07; + AC	6 PK 1748
				ALT	UNTIL: 05.03; - AC	6 PK 1420
				ALT	UNTIL: 05.07; + AC	6 PK 1718
				INJ-P		ZRK 1353
				INJ-P	AU	KT 1319

#### 1.8 TDCi

1753 ccm	81 kW	RWPA;RWPC;RWPD	08.06 -	ALT	- AC	6 PK 1460
				ALT	FROM: 05.07; + AC	6 PK 1748
				ALT	UNTIL: 05.07; + AC	6 PK 1718
				CAM		ZRK 1353
				CAM		KT 1319

### TRANSIT TOURNEO

#### 2.0

1998 ccm	84 kW	NSH	11.94 - 12.00	ALT	- AC; - PS; - EXT-HEAT	6 PK 1413
				ALT	+ AC; + PS; - EXT-HEAT	6 PK 1975
				ALT	+ EXT-HEAT	6 PK 1930
				ALT	+ PS; - AC; - EXT-HEAT	6 PK 1775

#### 2.4 D

2496 ccm	55 kW	4HA	08.94 - 06.00	ALT		4 PK 1510
				PS	- AC; + EXT-HEAT	6 PK 1635
				PS	+ AC	6 PK 1432

#### 2.5 DI

2496 ccm	51 kW	4FA;4FB;4FC;4FD	11.94 - 12.00	ALT		4 PK 1510
				PS	- AC; + EXT-HEAT	6 PK 1635
				PS	+ AC	6 PK 1432
				CAM	FROM: 07.97	ZRK 1425
				CAM	UNTIL: 07.97	ZRK 1424
				CAM	FROM: 07.97	KT 1241
				CAM	UNTIL: 07.97	KT 1240

#### 2.5 DI

2496 ccm	56 kW	4HA;4HB;4HC	11.94 - 12.00	CAM	FROM: 07.97	ZRK 1425
				CAM	UNTIL: 07.97	ZRK 1424
				CAM	FROM: 07.97	KT 1241
				CAM	UNTIL: 07.97	KT 1240

#### 2.5 TD

2496 ccm	63 kW	4GA;4GB;4GC	11.94 - 12.00	ALT	- AC; + STD-HEAT	4 PK 1485
				PS	- AC; + EXT-HEAT	6 PK 1635
				PS	+ AC	6 PK 1432
				CAM	FROM: 07.97	ZRK 1425
				CAM	UNTIL: 07.97	ZRK 1424
				CAM	FROM: 07.97	KT 1241
				CAM	UNTIL: 07.97	KT 1240

#### 2.5 TD

2496 ccm	74 kW	4EB;4EC	04.98 - 12.00	ALT		4 PK 1510
----------	-------	---------	---------------	-----	--	-----------



## FORD

### TRANSIT TOURNEO

2.5 TD							
2496 ccm	74 kW	4EB;4EC	04.98 - 12.00	PS	- AC; + EXT-HEAT		6 PK 1635
				PS	+ AC		6 PK 1432
				CAM			ZRK 1425
				CAM			KT 1241

### TRANSIT Bus (E\_ \_)

#### 2.0 (EBL, EBS, ECL, EDS, EDL, EGL, ESS, ESL, EUS)

1998 ccm	84 kW	NSF;NSG	09.95 - 03.00	ALT	MTR-CODE: NSF;NSH; MOD: 100; - AC; - PS; - EXT-HEAT		6 PK 1413
				ALT	MTR-CODE: NSF;NSH; MOD: 100; + AC; + PS; - EXT-HEAT		6 PK 1975
				ALT	MTR-CODE: NSF;NSH; MOD: 100; + EXT-HEAT		6 PK 1930
				ALT	MTR-CODE: NSF;NSH; MOD: 100; + PS; - AC; - EXT-HEAT		6 PK 1775
				ALT	MTR-CODE: NSF;NSH; MOD: 150; - AC; - PS; - EXT-HEAT		6 PK 1413
				ALT	MTR-CODE: NSF;NSH; MOD: 150; + AC; + PS; - EXT-HEAT		6 PK 1975
				ALT	MTR-CODE: NSF;NSH; MOD: 150; + EXT-HEAT		6 PK 1930
				ALT	MTR-CODE: NSF;NSH; MOD: 150; + PS; - AC; - EXT-HEAT		6 PK 1775

#### 2.5 DI (EBL, EDS, ESL, ESS, EUS)

2496 ccm	51 kW	4FA;4FB;4FC;4FD	08.94 - 03.00	ALT	FROM: 08.97; MTR-CODE: 4BC;4CC;4DA;4EA;4EB; MOD: 190		4 PK 1510
				ALT	MTR-CODE: 4EB;4EC;4FB;4FD;4HA; MOD: 100		4 PK 1510
				PS	MTR-CODE: 4BC;4CC;4DA;4EA;4EB; MOD: 190; - AC; + EXT-HEAT		6 PK 1635
				PS	MTR-CODE: 4BC;4CC;4DA;4EA;4EB; MOD: 190; + AC		6 PK 1432
				PS	MTR-CODE: 4EB;4EC;4FB;4FD;4HA; MOD: 100; - AC; + EXT-HEAT		6 PK 1635
				PS	MTR-CODE: 4EB;4EC;4FB;4FD;4HA; MOD: 100; + AC		6 PK 1432
				CAM	FROM: 10.97		ZRK 1425
				CAM	UNTIL: 09.97		ZRK 1424
				CAM	FROM: 07.97		KT 1241
				CAM	UNTIL: 07.97		KT 1240

#### 2.5 TD (EB\_, ED\_, ES\_)

2496 ccm	55 kW	4HA;4HD	08.94 - 06.00	ALT	MTR-CODE: 4EB;4EC;4ED;4GC;4GD; MOD: 150; - AC; + EXT-HEAT		6 PK 1635
				ALT	MTR-CODE: 4EB;4EC;4ED;4GC;4GD; MOD: 150; + AC		6 PK 1432
				ALT	MTR-CODE: 4EB;4EC;4FB;4FD;4HA; MOD: 100		4 PK 1510
				PS	MTR-CODE: 4EB;4EC;4FB;4FD;4HA; MOD: 100; - AC; + EXT-HEAT		6 PK 1635
				PS	MTR-CODE: 4EB;4EC;4FB;4FD;4HA; MOD: 100; + AC		6 PK 1432
				CAM			ZRK 1425
				CAM			KT 1241

#### 2.5 DI (EBL, ECL, EDS, EDL)

2496 ccm	56 kW	4HB;4HC	07.94 - 03.00	ALT	MOD: 100		4 PK 1485
				PS	MOD: 100; - AC; + EXT-HEAT		6 PK 1635
				PS	MOD: 100; + AC		6 PK 1432
				CAM	FROM: 10.97		ZRK 1425
				CAM	UNTIL: 09.97		ZRK 1424
				CAM	FROM: 10.97		KT 1241
				CAM	UNTIL: 09.97		KT 1240

#### 2.5 TD (EBL, EDL, EDS, EGL, ESL, ESS, EUS)

2496 ccm	63 kW	4GA;4GB;4GC;4GD;4GE;4GF	01.95 - 03.00	ALT	MTR-CODE: 4EB;4EC;4ED;4GC;4GD; MOD: 150; - AC; + EXT-HEAT		6 PK 1635
				ALT	MTR-CODE: 4EB;4EC;4ED;4GC;4GD; MOD: 150; - AC; + STD-HEAT		4 PK 1485
				ALT	MTR-CODE: 4EB;4EC;4ED;4GC;4GD; MOD: 150; + AC		6 PK 1432
				ALT	MTR-CODE: 4GC;4GD; MOD: 100		4 PK 1485
				PS	MTR-CODE: 4GC;4GD; MOD: 100; - AC; + EXT-HEAT		6 PK 1635
				PS	MTR-CODE: 4GC;4GD; MOD: 100; + AC		6 PK 1432
				CAM	FROM: 10.97		ZRK 1425
				CAM	UNTIL: 09.97		ZRK 1424



## FORD

### TRANSIT Bus (E\_ \_)

#### 2.5 TD (EBL, EDL, EDS, EGL, ESL, ESS, EUS)

2496 ccm	63 kW	4GA;4GB;4GC;4GD;4GE;4GF	01.95 - 03.00	CAM	FROM: 10.97	KT 1241
				CAM	UNTIL: 09.97	KT 1240

#### 2.5 TD (ECL, EDL, EDS, ESL, ESS, EUS)

2496 ccm	74 kW	4EB;4EC	07.94 - 03.00	ALT	MOD: 150; - AC; + EXT-HEAT	6 PK 1635
				ALT	MOD: 150; - AC; + STD-HEAT	4 PK 1485
				ALT	MOD: 150; + AC	6 PK 1432
				CAM	FROM: 10.97	ZRK 1425
				CAM	UNTIL: 09.97	ZRK 1424
				CAM	FROM: 09.97	KT 1241
				CAM	UNTIL: 09.97	KT 1240

#### 2.5 DI (EBL, EDL, EDS, ESL, ESS)

2496 ccm	85 kW	4ED	08.97 - 03.00	ALT	MTR-CODE: 4EB;4EC;4ED;4GC;4GD; MOD: 150; - AC; + EXT-HEAT	6 PK 1635
				ALT	MTR-CODE: 4EB;4EC;4ED;4GC;4GD; MOD: 150; - AC; + STD-HEAT	4 PK 1485
				ALT	MTR-CODE: 4EB;4EC;4ED;4GC;4GD; MOD: 150; + AC	6 PK 1432
				ALT	MTR-CODE: 4ED;4HA; MOD: 190	4 PK 1485
				PS	FROM: 12.98; MTR-CODE: 4ED; MOD: 100; - AC; + EXT-HEAT	6 PK 1635
				PS	FROM: 12.98; MTR-CODE: 4ED; MOD: 100; + AC	6 PK 1432
				PS	MTR-CODE: 4ED;4HA; MOD: 190; - AC; + EXT-HEAT	6 PK 1635
				PS	MTR-CODE: 4ED;4HA; MOD: 190; + AC	6 PK 1432
				CAM	FROM: 10.97	ZRK 1425
				CAM		KT 1241

### TRANSIT Kasten (E\_ \_)

#### 2.0 (EAL, EAS)

1998 ccm	84 kW	NSF;NSG	06.94 - 03.00	ALT	MOD: 80; - AC; - PS; - EXT-HEAT	6 PK 1413
				ALT	MOD: 80; + AC; + PS; - EXT-HEAT	6 PK 1975
				ALT	MOD: 80; + EXT-HEAT	6 PK 1930
				ALT	MOD: 80; + PS; - AC; - EXT-HEAT	6 PK 1775

#### 2.5 DI (EAL, EAS)

2496 ccm	51 kW	4FA;4FB;4FC;4FD	06.94 - 03.00	ALT	FROM: 02.95; MTR-CODE: 4BA;4BC;4CC;4FA; MOD: 80	4 PK 1510
				ALT	FROM: 08.97; MTR-CODE: 4BC;4CC;4DA;4EA;4EB; MOD: 190	4 PK 1510
				ALT	MTR-CODE: 4EB;4EC;4FB;4FD;4HA; MOD: 100	4 PK 1510
				ALT	UNTIL: 02.95; MTR-CODE: 4BA;4BC;4CC;4FA; MOD: 80	4 PK 1520
				ALT	UNTIL: 07.94; MTR-CODE: 4BC;4CC;4DA;4EA;4EB; MOD: 190	4 PK 1520
				PS	MTR-CODE: 4BC;4CC;4DA;4EA;4EB; MOD: 190; - AC; + EXT-HEAT	6 PK 1635
				PS	MTR-CODE: 4BC;4CC;4DA;4EA;4EB; MOD: 190; + AC	6 PK 1432
				PS	MTR-CODE: 4EB;4EC;4FB;4FD;4HA; MOD: 100; - AC; + EXT-HEAT	6 PK 1635
				PS	MTR-CODE: 4EB;4EC;4FB;4FD;4HA; MOD: 100; + AC	6 PK 1432
				CAM	FROM: 10.97	ZRK 1425
				CAM	UNTIL: 09.97	ZRK 1424
				CAM	FROM: 07.97	KT 1241
				CAM	UNTIL: 07.97	KT 1240

#### 2.5 TD (EAS)

2496 ccm	55 kW	4HA;4HD	10.98 - 03.00	ALT	MTR-CODE: 4EB;4EC;4ED;4GC;4GD; MOD: 150; - AC; + EXT-HEAT	6 PK 1635
				ALT	MTR-CODE: 4EB;4EC;4ED;4GC;4GD; MOD: 150; + AC	6 PK 1432
				ALT	MTR-CODE: 4EB;4EC;4FB;4FD;4HA; MOD: 100	4 PK 1510
				PS	MTR-CODE: 4EB;4EC;4FB;4FD;4HA; MOD: 100; - AC; + EXT-HEAT	6 PK 1635
				PS	MTR-CODE: 4EB;4EC;4FB;4FD;4HA; MOD: 100; + AC	6 PK 1432
				CAM		ZRK 1425
				CAM		KT 1241

#### 2.5 DI (EAL, EAS)

2496 ccm	56 kW	4HB;4HC	06.94 - 03.00	ALT	MOD: 190	4 PK 1485
----------	-------	---------	---------------	-----	----------	-----------



## FORD

### TRANSIT Kasten (E\_ \_)

#### 2.5 DI (EAL, EAS)

2496 ccm	56 kW	4HB;4HC	06.94 - 03.00	PS	MOD: 190; - AC; + EXT-HEAT	6 PK 1635
				PS	MOD: 190; + AC	6 PK 1432
				CAM	FROM: 10.97	ZRK 1425
				CAM	UNTIL: 09.97	ZRK 1424
				CAM	FROM: 07.97	KT 1241
				CAM	UNTIL: 07.97	KT 1240

#### 2.5 TD (EAL, EAS)

2496 ccm	63 kW	4GA;4GB;4GC;4GD;4GE;4GF	06.94 - 03.00	ALT	MTR-CODE: 4EB;4EC;4ED;4GC;4GD; MOD: 150; - AC; + EXT-HEAT	6 PK 1635
				ALT	MTR-CODE: 4EB;4EC;4ED;4GC;4GD; MOD: 150; - AC; + STD-HEAT	4 PK 1485
				ALT	MTR-CODE: 4EB;4EC;4ED;4GC;4GD; MOD: 150; + AC	6 PK 1432
				ALT	MTR-CODE: 4GC;4GD; MOD: 100	4 PK 1485
				ALT	UNTIL: 08.97; MTR-CODE: 4BC;4CC;4DA;4EA;4EB; MOD: 190	4 PK 1485
				PS	MTR-CODE: 4BC;4CC;4DA;4EA;4EB; MOD: 190; - AC; + EXT-HEAT	6 PK 1635
				PS	MTR-CODE: 4BC;4CC;4DA;4EA;4EB; MOD: 190; + AC	6 PK 1432
				PS	MTR-CODE: 4GC;4GD; MOD: 100; - AC; + EXT-HEAT	6 PK 1635
				PS	MTR-CODE: 4GC;4GD; MOD: 100; + AC	6 PK 1432
				CAM	FROM: 10.97	ZRK 1425
				CAM	UNTIL: 09.97	ZRK 1424
				CAM	FROM: 10.97	KT 1241
				CAM	UNTIL: 09.97	KT 1240

#### 2.5 TDI (EAL, EAS)

2496 ccm	74 kW	4EB;4EC	06.94 - 03.00	ALT	FROM: 08.97; MTR-CODE: 4BC;4CC;4DA;4EA;4EB; MOD: 190	4 PK 1510
				ALT	MTR-CODE: 4EB;4EC;4ED;4GC;4GD; MOD: 150; - AC; + EXT-HEAT	6 PK 1635
				ALT	MTR-CODE: 4EB;4EC;4ED;4GC;4GD; MOD: 150; - AC; + STD-HEAT	4 PK 1485
				ALT	MTR-CODE: 4EB;4EC;4ED;4GC;4GD; MOD: 150; + AC	6 PK 1432
				ALT	MTR-CODE: 4EB;4EC;4FB;4FD;4HA; MOD: 100	4 PK 1510
				ALT	MTR-CODE: 4EC;4GC;4GD; MOD: 230	4 PK 1485
				ALT	UNTIL: 07.94; MTR-CODE: 4BC;4CC;4DA;4EA;4EB; MOD: 190	4 PK 1520
				ALT	UNTIL: 08.97; MTR-CODE: 4BC;4CC;4DA;4EA;4EB; MOD: 190	4 PK 1485
				PS	MTR-CODE: 4BC;4CC;4DA;4EA;4EB; MOD: 190; - AC; + EXT-HEAT	6 PK 1635
				PS	MTR-CODE: 4BC;4CC;4DA;4EA;4EB; MOD: 190; + AC	6 PK 1432
				PS	MTR-CODE: 4EB;4EC;4FB;4FD;4HA; MOD: 100; - AC; + EXT-HEAT	6 PK 1635
				PS	MTR-CODE: 4EB;4EC;4FB;4FD;4HA; MOD: 100; + AC	6 PK 1432
				PS	MTR-CODE: 4EC;4GC;4GD; MOD: 230; - AC; + EXT-HEAT	6 PK 1635
				PS	MTR-CODE: 4EC;4GC;4GD; MOD: 230; + AC	6 PK 1432
				CAM	FROM: 10.97	ZRK 1425
				CAM	UNTIL: 09.97	ZRK 1424
				CAM	FROM: 10.97	KT 1241
				CAM	UNTIL: 09.97	KT 1240

#### 2.5 DI (EAL, EAS)

2496 ccm	85 kW	4ED	05.99 - 03.00	PS		AVX 13 x 1015 TM
				VAC-P		AVX 10 x 935
				ALT	MTR-CODE: 4EB;4EC;4ED;4GC;4GD; MOD: 150; - AC; + EXT-HEAT	6 PK 1635
				ALT	MTR-CODE: 4EB;4EC;4ED;4GC;4GD; MOD: 150; - AC; + STD-HEAT	4 PK 1485
				ALT	MTR-CODE: 4EB;4EC;4ED;4GC;4GD; MOD: 150; + AC	6 PK 1432
				ALT	MTR-CODE: 4ED; MOD: 100; - AC; + EXT-HEAT	6 PK 1635
				ALT	MTR-CODE: 4ED; MOD: 100; + AC	6 PK 1432
				ALT	MTR-CODE: 4ED;4HA; MOD: 190	4 PK 1485
				PS	MTR-CODE: 4ED;4HA; MOD: 190; - AC; + EXT-HEAT	6 PK 1635

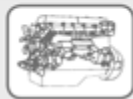

## FORD

### TRANSIT Kasten (E\_ \_)

#### 2.5 DI (EAL, EAS)

2496 ccm	85 kW	4ED	05.99 - 03.00	PS CAM CAM	MTR-CODE: 4ED;4HA; MOD: 190; + AC	<b>6 PK 1432</b> <b>ZRK 1425</b> <b>KT 1241</b>
----------	-------	-----	---------------	------------------	-----------------------------------	---

### TRANSIT Pritsche/Fahrgestell (E\_ \_)

#### 2.0 (EME/L/S, ENE/L/S)

1998 ccm	84 kW	NSF;NSG	08.94 - 03.00	ALT	MTR-CODE: NSF; MOD: 120; - AC; - PS; - EXT-HEAT	<b>6 PK 1413</b>
				ALT	MTR-CODE: NSF; MOD: 120; + AC; + PS; - EXT-HEAT	<b>6 PK 1975</b>
				ALT	MTR-CODE: NSF; MOD: 120; + EXT-HEAT	<b>6 PK 1930</b>
				ALT	MTR-CODE: NSF; MOD: 120; + PS; - AC; - EXT-HEAT	<b>6 PK 1775</b>
				ALT	MTR-CODE: NSF;NSH; MOD: 100; - AC; - PS; - EXT-HEAT	<b>6 PK 1413</b>
				ALT	MTR-CODE: NSF;NSH; MOD: 100; + AC; + PS; - EXT-HEAT	<b>6 PK 1975</b>
				ALT	MTR-CODE: NSF;NSH; MOD: 100; + EXT-HEAT	<b>6 PK 1930</b>
				ALT	MTR-CODE: NSF;NSH; MOD: 100; + PS; - AC; - EXT-HEAT	<b>6 PK 1775</b>
				ALT	MTR-CODE: NSF;NSH; MOD: 150; - AC; - PS; - EXT-HEAT	<b>6 PK 1413</b>
				ALT	MTR-CODE: NSF;NSH; MOD: 150; + AC; + PS; - EXT-HEAT	<b>6 PK 1975</b>
				ALT	MTR-CODE: NSF;NSH; MOD: 150; + EXT-HEAT	<b>6 PK 1930</b>
				ALT	MTR-CODE: NSF;NSH; MOD: 150; + PS; - AC; - EXT-HEAT	<b>6 PK 1775</b>
				ALT	MTR-CODE: NSF;NSH; MOD: 190; - AC; - PS; - EXT-HEAT	<b>6 PK 1413</b>
				ALT	MTR-CODE: NSF;NSH; MOD: 190; + AC; + PS; - EXT-HEAT	<b>6 PK 1975</b>
				ALT	MTR-CODE: NSF;NSH; MOD: 190; + EXT-HEAT	<b>6 PK 1930</b>
				ALT	MTR-CODE: NSF;NSH; MOD: 190; + PS; - AC; - EXT-HEAT	<b>6 PK 1775</b>

#### 2.5 DI (EML/S, ENL/S)

2496 ccm	51 kW	4FA;4FB;4FC;4FD	08.94 - 03.00	ALT	FROM: 08.97; MTR-CODE: 4BC;4CC;4DA;4EA;4EB; MOD: 190	<b>4 PK 1510</b>
				ALT	MTR-CODE: 4EB;4EC;4FB;4FD;4HA; MOD: 100	<b>4 PK 1510</b>
				ALT	MTR-CODE: 4FA; MOD: 120	<b>4 PK 1510</b>
				PS	MTR-CODE: 4BC;4CC;4DA;4EA;4EB; MOD: 190; - AC; + EXT-HEAT	<b>6 PK 1635</b>
				PS	MTR-CODE: 4BC;4CC;4DA;4EA;4EB; MOD: 190; + AC	<b>6 PK 1432</b>
				PS	MTR-CODE: 4EB;4EC;4FB;4FD;4HA; MOD: 100; - AC; + EXT-HEAT	<b>6 PK 1635</b>
				PS	MTR-CODE: 4EB;4EC;4FB;4FD;4HA; MOD: 100; + AC	<b>6 PK 1432</b>
				PS	MTR-CODE: 4FA; MOD: 120; - AC; + EXT-HEAT	<b>6 PK 1635</b>
				PS	MTR-CODE: 4FA; MOD: 120; + AC	<b>6 PK 1432</b>
				CAM	FROM: 10.97	<b>ZRK 1425</b>
				CAM	UNTIL: 09.97	<b>ZRK 1424</b>
				CAM	FROM: 07.97	<b>KT 1241</b>
				CAM	UNTIL: 07.97	<b>KT 1240</b>

#### 2.5 TD (EME/L/S, ENE/L/S)

2496 ccm	55 kW	4HA;4HD	10.98 - 07.00	ALT	MTR-CODE: 4EB;4EC;4ED;4GC;4GD; MOD: 150; - AC; + EXT-HEAT	<b>6 PK 1635</b>
				ALT	MTR-CODE: 4EB;4EC;4ED;4GC;4GD; MOD: 150; + AC	<b>6 PK 1432</b>
				ALT	MTR-CODE: 4EB;4EC;4FB;4FD;4HA; MOD: 100	<b>4 PK 1510</b>
				ALT	MTR-CODE: 4HA; MOD: 120	<b>4 PK 1510</b>
				PS	MTR-CODE: 4EB;4EC;4FB;4FD;4HA; MOD: 100; - AC; + EXT-HEAT	<b>6 PK 1635</b>
				PS	MTR-CODE: 4EB;4EC;4FB;4FD;4HA; MOD: 100; + AC	<b>6 PK 1432</b>
				PS	MTR-CODE: 4HA; MOD: 120; - AC; + EXT-HEAT	<b>6 PK 1635</b>
				PS	MTR-CODE: 4HA; MOD: 120; + AC	<b>6 PK 1432</b>
				CAM		<b>ZRK 1425</b>
				CAM		<b>KT 1241</b>

#### 2.5 DI (EME/L/S, ENE/L/S)

2496 ccm	56 kW	4HB;4HC	08.94 - 03.00	ALT	MTR-CODE: 4HB; MOD: 100	<b>4 PK 1485</b>
				ALT	MTR-CODE: 4HC; MOD: 120	<b>4 PK 1485</b>

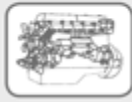

**FORD**
**TRANSIT Pritsche/Fahrgestell (E\_\_)**
**2.5 DI (EME/L/S, ENE/L/S)**

2496 ccm	56 kW	4HB;4HC	08.94 - 03.00	PS	MTR-CODE: 4HB; MOD: 100; - AC; + EXT-HEAT	6 PK 1635
				PS	MTR-CODE: 4HB; MOD: 100; + AC	6 PK 1432
				PS	MTR-CODE: 4HC; MOD: 120; - AC; + EXT-HEAT	6 PK 1635
				PS	MTR-CODE: 4HC; MOD: 120; + AC	6 PK 1432
				CAM	FROM: 10.97	ZRK 1425
				CAM	UNTIL: 09.97	ZRK 1424
				CAM	FROM: 07.97	KT 1241
				CAM	UNTIL: 07.97	KT 1240

**2.5 TD (EME/L/S, ENE/L/S)**

2496 ccm	63 kW	4GA;4GB;4GC;4GD;4GE;4GF	08.94 - 03.00	ALT	MTR-CODE: 4EB;4EC;4ED;4GC;4GD; MOD: 150; - AC; + EXT-HEAT	6 PK 1635
				ALT	MTR-CODE: 4EB;4EC;4ED;4GC;4GD; MOD: 150; - AC; + STD-HEAT	4 PK 1485
				ALT	MTR-CODE: 4EB;4EC;4ED;4GC;4GD; MOD: 150; + AC	6 PK 1432
				ALT	MTR-CODE: 4EC;4GC;4GD; MOD: 230	4 PK 1485
				ALT	MTR-CODE: 4GC; MOD: 120	4 PK 1485
				ALT	MTR-CODE: 4GC;4GD; MOD: 100	4 PK 1485
				ALT	UNTIL: 08.97; MTR-CODE: 4BC;4CC;4DA;4EA;4EB; MOD: 190	4 PK 1485
				PS	MTR-CODE: 4BC;4CC;4DA;4EA;4EB; MOD: 190; - AC; + EXT-HEAT	6 PK 1635
				PS	MTR-CODE: 4BC;4CC;4DA;4EA;4EB; MOD: 190; + AC	6 PK 1432
				PS	MTR-CODE: 4EC;4GC;4GD; MOD: 230; - AC; + EXT-HEAT	6 PK 1635
				PS	MTR-CODE: 4EC;4GC;4GD; MOD: 230; + AC	6 PK 1432
				PS	MTR-CODE: 4GC; MOD: 120; - AC; + EXT-HEAT	6 PK 1635
				PS	MTR-CODE: 4GC; MOD: 120; + AC	6 PK 1432
				PS	MTR-CODE: 4GC;4GD; MOD: 100; - AC; + EXT-HEAT	6 PK 1635
				PS	MTR-CODE: 4GC;4GD; MOD: 100; + AC	6 PK 1432
				CAM	FROM: 10.97	ZRK 1425
				CAM	UNTIL: 09.97	ZRK 1424
				CAM	FROM: 10.97	KT 1241
				CAM	UNTIL: 09.97	KT 1240

**2.5 TD (EME/L/S, ENE/L/S)**

2496 ccm	74 kW	4EB;4EC	08.94 - 03.00	ALT	FROM: 08.97; MTR-CODE: 4BC;4CC;4DA;4EA;4EB; MOD: 190	4 PK 1510
				ALT	MTR-CODE: 4EB;4EC;4ED;4GC;4GD; MOD: 150; - AC; + EXT-HEAT	6 PK 1635
				ALT	MTR-CODE: 4EB;4EC;4ED;4GC;4GD; MOD: 150; - AC; + STD-HEAT	4 PK 1485
				ALT	MTR-CODE: 4EB;4EC;4ED;4GC;4GD; MOD: 150; + AC	6 PK 1432
				ALT	MTR-CODE: 4EB;4EC;4FB;4FD;4HA; MOD: 100	4 PK 1510
				ALT	MTR-CODE: 4EC;4GC;4GD; MOD: 230	4 PK 1485
				ALT	UNTIL: 08.97; MTR-CODE: 4BC;4CC;4DA;4EA;4EB; MOD: 190	4 PK 1485
				PS	MTR-CODE: 4BC;4CC;4DA;4EA;4EB; MOD: 190; - AC; + EXT-HEAT	6 PK 1635
				PS	MTR-CODE: 4BC;4CC;4DA;4EA;4EB; MOD: 190; + AC	6 PK 1432
				PS	MTR-CODE: 4EB;4EC;4FB;4FD;4HA; MOD: 100; - AC; + EXT-HEAT	6 PK 1635
				PS	MTR-CODE: 4EB;4EC;4FB;4FD;4HA; MOD: 100; + AC	6 PK 1432
				PS	MTR-CODE: 4EC;4GC;4GD; MOD: 230; - AC; + EXT-HEAT	6 PK 1635
				PS	MTR-CODE: 4EC;4GC;4GD; MOD: 230; + AC	6 PK 1432
				CAM	FROM: 10.97	ZRK 1425
				CAM	UNTIL: 09.97	ZRK 1424
				CAM	FROM: 09.97	KT 1241
				CAM	UNTIL: 09.97	KT 1240

**2.5 DI (EML, ENE/L)**

2496 ccm	85 kW	4ED	05.99 - 03.00	ALT	MTR-CODE: 4EB;4EC;4ED;4GC;4GD; MOD: 150; - AC; + EXT-HEAT	6 PK 1635
				ALT	MTR-CODE: 4EB;4EC;4ED;4GC;4GD; MOD: 150; - AC; + STD-HEAT	4 PK 1485
				ALT	MTR-CODE: 4EB;4EC;4ED;4GC;4GD; MOD: 150; + AC	6 PK 1432

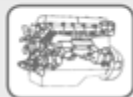

## FORD

### TRANSIT Pritsche/Fahrgestell (E\_ \_)

#### 2.5 DI (EML, ENE/L)

2496 ccm	85 kW	4ED	05.99 - 03.00	ALT	MTR-CODE: 4ED; MOD: 100; - AC; + EXT-HEAT	6 PK 1635
				ALT	MTR-CODE: 4ED; MOD: 100; + AC	6 PK 1432
				ALT	MTR-CODE: 4ED;4HA; MOD: 190	4 PK 1485
				PS	MTR-CODE: 4ED;4HA; MOD: 190; - AC; + EXT-HEAT	6 PK 1635
				PS	MTR-CODE: 4ED;4HA; MOD: 190; + AC	6 PK 1432
				CAM		ZRK 1425
				CAM		KT 1241

### TRANSIT Bus (FD\_ \_ , FB\_ \_ , FS\_ \_ , FZ\_ \_ , FC\_ \_)

#### 2.0 DI (F\_E\_ , F\_F\_ , F\_G\_ )

1998 ccm	55 kW	D3FA	08.00 - 05.06	ALT	- AC	6 EPK 831
				ALT	MOD: 260; + AC	6 PK 1642
				ALT	MOD: 280; + AC	6 PK 1642
				ALT	MOD: 300; + AC	6 PK 1642
				PS	FROM: 04.03	4 EPK 711
				PS	MOD: 260; AU	4 PK 735
				PS	MOD: 280; AU	4 PK 735
				PS	MOD: 300; AU	4 PK 735

#### 2.0 DI (F\_E\_ , F\_F\_ , F\_G\_ )

1998 ccm	63 kW	F3FA	08.00 - 05.06	ALT	- AC	6 EPK 831
				ALT	MTR-CODE: ABFA;ABFB;F3FA; MOD: 300; + AC	6 PK 1642
				ALT	MTR-CODE: F3FA; MOD: 260; + AC	6 PK 1642
				ALT	MTR-CODE: F3FA; MOD: 280; + AC	6 PK 1642
				PS	FROM: 04.03	4 EPK 711
				PS	MTR-CODE: ABFA;ABFB;F3FA; MOD: 300; AU	4 PK 735
				PS	MTR-CODE: F3FA; MOD: 260; AU	4 PK 735
				PS	MTR-CODE: F3FA; MOD: 280; AU	4 PK 735

#### 2.0 DI (F\_E\_ , F\_F\_ , F\_G\_ )

1998 ccm	74 kW	ABFA	08.00 - 05.06	ALT	- AC	6 EPK 831
				ALT	MTR-CODE: ABFA;ABFB; MOD: 260; + AC	6 PK 1642
				ALT	MTR-CODE: ABFA;ABFB; MOD: 280; + AC	6 PK 1642
				ALT	MTR-CODE: ABFA;ABFB; MOD: 300; + AC	6 PK 1642
				ALT	MTR-CODE: ABFA;ABFB;F3FA; MOD: 300; + AC	6 PK 1642
				PS	FROM: 04.03	4 EPK 711
				PS	MTR-CODE: ABFA;ABFB; MOD: 260; AU	4 PK 735
				PS	MTR-CODE: ABFA;ABFB; MOD: 280; AU	4 PK 735
				PS	MTR-CODE: ABFA;ABFB; MOD: 300; AU	4 PK 735
				PS	MTR-CODE: ABFA;ABFB;F3FA; MOD: 300; AU	4 PK 735

#### 2.0 TDCi (F\_F\_ , F\_E\_ , F\_G\_ )

1998 ccm	92 kW	F1FA	08.02 - 05.06	ALT	- AC	6 EPK 831
				ALT	MOD: 280; + AC	6 PK 1642
				ALT	MOD: 300; + AC	6 PK 1642
				PS	FROM: 04.03	4 EPK 711
				PS	MOD: 280; AU	4 PK 735
				PS	MOD: 300; AU	4 PK 735

#### 2.3 16V [RWD] (F\_B\_ , F\_C\_ , F\_A\_ )

2295 ccm	107 kW	E5FA;E5FC	08.00 - 05.06	ALT	MTR-CODE: E5FA; MOD: 350; - AC	6 PK 1775
				ALT	MTR-CODE: E5FA; MOD: 350; + AC	6 PK 1950
				ALT	MTR-CODE: E5FA;E5FC; MOD: 330; - AC	6 PK 1775
				ALT	MTR-CODE: E5FA;E5FC; MOD: 330; + AC	6 PK 1950

#### 2.4 DI [RWD] (F\_B\_ , F\_C\_ )

2402 ccm	55 kW	F4FA	01.00 - 05.06	ALT	FROM: 08.00; MOD: 330; - AC	7 PK 2710 TM
				ALT	FROM: 08.00; MOD: 330; + AC	7 PK 2875 TM
				ALT	FROM: 09.00; MOD: 350; - AC	7 PK 2710 TM
				ALT	FROM: 09.00; MOD: 350; + AC	7 PK 2875 TM

#### 2.4 DI (F\_B\_ , F\_C\_ , F\_A\_ )

2402 ccm	66 kW	D2FA;D2FB;D2FE	01.00 - 05.06	ALT	FROM: 10.01; MTR-CODE: D2FE; MOD: 330; - AC	7 PK 2710 TM
				ALT	FROM: 10.01; MTR-CODE: D2FE; MOD: 330; + AC	7 PK 2875 TM
				ALT	FROM: 10.01; MTR-CODE: D2FE; MOD: 350; - AC	7 PK 2710 TM
				ALT	FROM: 10.01; MTR-CODE: D2FE; MOD: 350; + AC	7 PK 2875 TM

#### 2.4 TDE

2402 ccm	85 kW	FXFA	03.04 - 05.06	ALT	MOD: 300; - AC	7 PK 2710 TM
----------	-------	------	---------------	-----	----------------	--------------

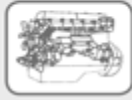

## FORD

### TRANSIT Bus (FD\_, FB\_, FS\_, FZ\_, FC\_)

#### 2.4 TDE

2402 ccm	85 kW	FXFA	03.04 - 05.06	ALT	MOD: 300; + AC	7 PK 2875 TM
				ALT	MOD: 330; - AC	7 PK 2710 TM
				ALT	MOD: 330; + AC	7 PK 2875 TM
				ALT	MOD: 350; - AC	7 PK 2710 TM
				ALT	MOD: 350; + AC	7 PK 2875 TM

#### 2.4 DI [RWD] (F\_B\_, F\_C\_, F\_A\_)

2402 ccm	88 kW	D4FA	01.00 - 05.06	ALT	FROM: 08.00; MOD: 330; - AC	7 PK 2710 TM
				ALT	FROM: 08.00; MOD: 330; + AC	7 PK 2875 TM
				ALT	FROM: 08.00; MOD: 350; - AC	7 PK 2710 TM
				ALT	FROM: 08.00; MOD: 350; + AC	7 PK 2875 TM

#### 2.4 TDE (F\_C\_, F\_B\_, F\_A\_)

2402 ccm	92 kW	DOFA	07.01 - 05.06	ALT	MTR-CODE: DOFA;TBE; MOD: 330; - AC	7 PK 2710 TM
				ALT	MTR-CODE: DOFA;TBE; MOD: 330; + AC	7 PK 2875 TM
				ALT	MTR-CODE: DOFA;TBE; MOD: 350; - AC	7 PK 2710 TM
				ALT	MTR-CODE: DOFA;TBE; MOD: 350; + AC	7 PK 2875 TM

#### 2.4 TDCi

2402 ccm	101 kW	H9FA	03.04 - 05.06	ALT	MOD: 330; - AC	7 PK 2710 TM
				ALT	MOD: 330; + AC	7 PK 2875 TM
				ALT	MOD: 350; - AC	7 PK 2710 TM
				ALT	MOD: 350; + AC	7 PK 2875 TM

### TRANSIT Kasten (FA\_)

#### 2.3

2295 ccm	105 kW	E5FC	03.01 - 03.06	ALT	MOD: 330; - AC	6 PK 1775
				ALT	MOD: 330; + AC	6 PK 1950

#### 2.3 16V [RWD] (FAA\_, FAB\_, FAC\_)

2295 ccm	107 kW	E5FA;E5FC	04.01 - 05.06	ALT	MTR-CODE: E5FA; MOD: 350; - AC	6 PK 1775
				ALT	MTR-CODE: E5FA; MOD: 350; + AC	6 PK 1950
				ALT	MTR-CODE: E5FA;E5FC; MOD: 330; - AC	6 PK 1775
				ALT	MTR-CODE: E5FA;E5FC; MOD: 330; + AC	6 PK 1950

#### 2.0 DI (FAE\_, FAF\_, FAG\_)

1998 ccm	55 kW	D3FA	08.00 - 05.06	ALT	- AC	6 EPK 831
				ALT	MOD: 260; + AC	6 PK 1642
				ALT	MOD: 280; + AC	6 PK 1642
				PS	FROM: 04.03	4 EPK 711
				PS	MOD: 260; AU	4 PK 735
				PS	MOD: 280; AU	4 PK 735

#### 2.0 DI (FAE\_, FAF\_, FAG\_)

1998 ccm	63 kW	F3FA	08.00 - 05.06	ALT	- AC	6 EPK 831
				ALT	MOD: 260; + AC	6 PK 1642
				ALT	MOD: 280; + AC	6 PK 1642
				ALT	MOD: 300; + AC	6 PK 1642
				PS	FROM: 04.03	4 EPK 711
				PS	MOD: 260; AU	4 PK 735
				PS	MOD: 280; AU	4 PK 735
				PS	MOD: 300; AU	4 PK 735

#### 2.0 DI (FAE\_, FAF\_, FAG\_)

1998 ccm	74 kW	ABFA	08.00 - 05.06	ALT	- AC	6 EPK 831
				ALT	MTR-CODE: ABFA;ABFB; MOD: 260; + AC	6 PK 1642
				ALT	MTR-CODE: ABFA;ABFB; MOD: 280; + AC	6 PK 1642
				ALT	MTR-CODE: ABFA;ABFB; MOD: 300; + AC	6 PK 1642
				PS	FROM: 04.03	4 EPK 711
				PS	MTR-CODE: ABFA;ABFB; MOD: 260; AU	4 PK 735
				PS	MTR-CODE: ABFA;ABFB; MOD: 280; AU	4 PK 735
				PS	MTR-CODE: ABFA;ABFB; MOD: 300; AU	4 PK 735

#### 2.0 TDCi

1998 ccm	92 kW	F1FA	08.02 - 05.06	ALT	- AC	6 EPK 831
				ALT	MOD: 260; + AC	6 PK 1642
				ALT	MOD: 280; + AC	6 PK 1642
				ALT	MOD: 300; + AC	6 PK 1642
				PS	FROM: 04.03	4 EPK 711
				PS	MOD: 260; AU	4 PK 735
				PS	MOD: 280; AU	4 PK 735
				PS	MOD: 300; AU	4 PK 735

#### 2.4 TD

2402 ccm	55 kW	F4FA	08.00 - 08.03	ALT	MOD: 350; - AC	7 PK 2710 TM
----------	-------	------	---------------	-----	----------------	--------------

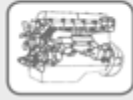

## FORD

### TRANSIT Kasten (FA\_\_)

#### 2.4 TD

2402 ccm 55 kW F4FA 08.00 - 08.03 ALT MOD: 350; + AC 7 PK 2875 TM

#### 2.4 DI [RWD] (FAA\_, FAB\_, FAC\_, FAD\_)

2402 ccm 55 kW F4FA 01.00 - 05.06 ALT MOD: 330; - AC 7 PK 2710 TM  
ALT MOD: 330; + AC 7 PK 2875 TM  
ALT MOD: 350; - AC 7 PK 2710 TM  
ALT MOD: 350; + AC 7 PK 2875 TM

#### 2.4 DI (FAA\_, FAB\_, FAC\_, FAD\_)

2402 ccm 66 kW D2FA;D2FB;D2FE 01.00 - 05.06 ALT FROM: 10.01; MTR-CODE: D2FE; MOD: 300; - AC 7 PK 2710 TM  
ALT FROM: 10.01; MTR-CODE: D2FE; MOD: 300; + AC 7 PK 2875 TM  
ALT MTR-CODE: D2FA;D2FE; MOD: 330; - AC 7 PK 2710 TM  
ALT MTR-CODE: D2FA;D2FE; MOD: 330; + AC 7 PK 2875 TM  
ALT MTR-CODE: D2FA;D2FE; MOD: 350; - AC 7 PK 2710 TM  
ALT MTR-CODE: D2FA;D2FE; MOD: 350; + AC 7 PK 2875 TM

#### 2.4 TDE

2402 ccm 85 kW FXFA 03.04 - 05.06 ALT MOD: 300; - AC 7 PK 2710 TM  
ALT MOD: 300; + AC 7 PK 2875 TM  
ALT MOD: 330; - AC 7 PK 2710 TM  
ALT MOD: 330; + AC 7 PK 2875 TM  
ALT MOD: 350; - AC 7 PK 2710 TM  
ALT MOD: 350; + AC 7 PK 2875 TM

#### 2.4 TDdi

2402 ccm 88 kW D4FA 08.00 - 08.03 ALT MOD: 260; - AC 7 PK 2710 TM  
ALT MOD: 260; + AC 7 PK 2875 TM  
ALT MOD: 280; - AC 7 PK 2710 TM  
ALT MOD: 280; + AC 7 PK 2875 TM  
ALT MOD: 330; - AC 7 PK 2710 TM  
ALT MOD: 330; + AC 7 PK 2875 TM  
ALT MOD: 350; - AC 7 PK 2710 TM  
ALT MOD: 350; + AC 7 PK 2875 TM

#### 2.4 DI [RWD] (FAA\_, FAB\_, FAC\_, FAD\_)

2402 ccm 88 kW D4FA 01.00 - 05.06 ALT FROM: 08.00; MOD: 350; - AC 7 PK 2710 TM  
ALT FROM: 08.00; MOD: 350; + AC 7 PK 2875 TM  
ALT MOD: 330; - AC 7 PK 2710 TM  
ALT MOD: 330; + AC 7 PK 2875 TM

#### 2.4 TDE

2402 ccm 92 kW DOFA 07.01 - 05.06 ALT MTR-CODE: DOFA;TBE; MOD: 300; - AC 7 PK 2710 TM  
ALT MTR-CODE: DOFA;TBE; MOD: 300; + AC 7 PK 2875 TM  
ALT MTR-CODE: DOFA;TBE; MOD: 330; - AC 7 PK 2710 TM  
ALT MTR-CODE: DOFA;TBE; MOD: 330; + AC 7 PK 2875 TM  
ALT MTR-CODE: DOFA;TBE; MOD: 350; - AC 7 PK 2710 TM  
ALT MTR-CODE: DOFA;TBE; MOD: 350; + AC 7 PK 2875 TM

#### 2.4 TDCi

2402 ccm 101 kW H9FA 03.04 - 05.06 ALT MOD: 330; - AC 7 PK 2710 TM  
ALT MOD: 330; + AC 7 PK 2875 TM  
ALT MOD: 350; - AC 7 PK 2710 TM  
ALT MOD: 350; + AC 7 PK 2875 TM

### TRANSIT Pritsche/Fahrgestell (FM\_\_, FN\_\_)

#### 2.3 16V (F\_A\_, F\_B\_, F\_C\_, F\_D\_)

2295 ccm 107 kW E5FA;E5FC 04.01 - 05.06 ALT MTR-CODE: E5FA; MOD: 350; - AC 6 PK 1775  
ALT MTR-CODE: E5FA; MOD: 350; + AC 6 PK 1950  
ALT MTR-CODE: E5FA;E5FC; MOD: 330; - AC 6 PK 1775  
ALT MTR-CODE: E5FA;E5FC; MOD: 330; + AC 6 PK 1950

#### 2.0 DI (F\_E\_, F\_F\_)

1998 ccm 55 kW D3FA 08.00 - 05.06 ALT - AC 6 EPK 831  
ALT MOD: 280; + AC 6 PK 1642  
PS FROM: 04.03 4 EPK 711  
PS MOD: 280; AU 4 PK 735

#### 2.0 DI (F\_E\_, F\_F\_)

1998 ccm 63 kW F3FA 08.00 - 05.06 ALT - AC 6 EPK 831  
ALT MTR-CODE: ABFA;ABFB;F3FA; MOD: 300; + AC 6 PK 1642  
ALT MTR-CODE: F3FA; MOD: 260; + AC 6 PK 1642  
ALT MTR-CODE: F3FA; MOD: 280; + AC 6 PK 1642  
ALT MTR-CODE: F3FA; MOD: 300; + AC 6 PK 1642



## FORD

### TRANSIT Pritsche/Fahrgestell (FM\_-, FN\_-)

#### 2.0 DI (F\_E\_, F\_F\_)

1998 ccm	63 kW	F3FA	08.00 - 05.06	PS	FROM: 04.03	4 EPK 711
				PS	MTR-CODE: ABFA;ABFB;F3FA; MOD: 300; AU	4 PK 735
				PS	MTR-CODE: F3FA; MOD: 260; AU	4 PK 735
				PS	MTR-CODE: F3FA; MOD: 280; AU	4 PK 735
				PS	MTR-CODE: F3FA; MOD: 300; AU	4 PK 735

#### 2.0 DI (F\_E\_, F\_F\_)

1998 ccm	74 kW	ABFA	08.00 - 05.06	ALT	- AC	6 EPK 831
				ALT	MTR-CODE: ABFA;ABFB; MOD: 260; + AC	6 PK 1642
				ALT	MTR-CODE: ABFA;ABFB; MOD: 280; + AC	6 PK 1642
				ALT	MTR-CODE: ABFA;ABFB; MOD: 300; + AC	6 PK 1642
				ALT	MTR-CODE: ABFA;ABFB;F3FA; MOD: 300; + AC	6 PK 1642
				PS	FROM: 04.03	4 EPK 711
				PS	MTR-CODE: ABFA;ABFB; MOD: 260; AU	4 PK 735
				PS	MTR-CODE: ABFA;ABFB; MOD: 280; AU	4 PK 735
				PS	MTR-CODE: ABFA;ABFB; MOD: 300; AU	4 PK 735
				PS	MTR-CODE: ABFA;ABFB;F3FA; MOD: 300; AU	4 PK 735

#### 2.0 TDCi (F\_E\_, F\_F\_)

1998 ccm	92 kW	F1FA	08.02 - 05.06	ALT	- AC	6 EPK 831
				ALT	MOD: 280; + AC	6 PK 1642
				ALT	MOD: 300; + AC	6 PK 1642
				PS	FROM: 04.03	4 EPK 711
				PS	MOD: 280; AU	4 PK 735
				PS	MOD: 300; AU	4 PK 735

#### 2.4 DI (F\_A\_, F\_B\_, F\_C\_, F\_D\_)

2402 ccm	55 kW	F4FA	01.00 - 05.06	ALT	MOD: 330; - AC	7 PK 2710 TM
				ALT	MOD: 330; + AC	7 PK 2875 TM
				ALT	MOD: 350; - AC	7 PK 2710 TM
				ALT	MOD: 350; + AC	7 PK 2875 TM

#### 2.4 DI (F\_A\_, F\_B\_, F\_C\_, F\_D\_)

2402 ccm	66 kW	D2FA;D2FB;D2FE	01.00 - 05.06	ALT	FROM: 10.01; MTR-CODE: D2FA; MOD: 430; - AC	7 PK 2710 TM
				ALT	FROM: 10.01; MTR-CODE: D2FA; MOD: 430; + AC	7 PK 2875 TM
				ALT	MTR-CODE: D2FA; MOD: 425; - AC	7 PK 2710 TM
				ALT	MTR-CODE: D2FA; MOD: 425; + AC	7 PK 2875 TM
				ALT	MTR-CODE: D2FA;D2FE; MOD: 330; - AC	7 PK 2710 TM
				ALT	MTR-CODE: D2FA;D2FE; MOD: 330; + AC	7 PK 2875 TM
				ALT	MTR-CODE: D2FA;D2FE; MOD: 350; - AC	7 PK 2710 TM
				ALT	MTR-CODE: D2FA;D2FE; MOD: 350; + AC	7 PK 2875 TM

#### 2.4 TDE

2402 ccm	85 kW	FXFA	03.04 - 05.06	ALT	MOD: 300; - AC	7 PK 2710 TM
				ALT	MOD: 300; + AC	7 PK 2875 TM
				ALT	MOD: 330; - AC	7 PK 2710 TM
				ALT	MOD: 330; + AC	7 PK 2875 TM
				ALT	MOD: 350; - AC	7 PK 2710 TM
				ALT	MOD: 350; + AC	7 PK 2875 TM

#### 2.4 TDdi

2402 ccm	88 kW	D4FA	08.00 - 08.03	ALT	MOD: 280; - AC	7 PK 2710 TM
				ALT	MOD: 280; + AC	7 PK 2875 TM

#### 2.4 DI (F\_A\_, F\_B\_, F\_C\_, F\_D\_)

2402 ccm	88 kW	D4FA	01.00 - 05.06	ALT	FROM: 08.00; MOD: 260; - AC	7 PK 2710 TM
				ALT	FROM: 08.00; MOD: 260; + AC	7 PK 2875 TM
				ALT	FROM: 08.00; MOD: 280; - AC	7 PK 2710 TM
				ALT	FROM: 08.00; MOD: 280; + AC	7 PK 2875 TM
				ALT	MOD: 330; - AC	7 PK 2710 TM
				ALT	MOD: 330; + AC	7 PK 2875 TM
				ALT	MOD: 350; - AC	7 PK 2710 TM
				ALT	MOD: 350; + AC	7 PK 2875 TM
				ALT	MOD: 425; - AC	7 PK 2710 TM
				ALT	MOD: 425; + AC	7 PK 2875 TM

#### 2.4 TDE

2402 ccm	92 kW	DOFA	07.01 - 05.06	ALT	MTR-CODE: DOFA;TBE; MOD: 330; - AC	7 PK 2710 TM
				ALT	MTR-CODE: DOFA;TBE; MOD: 330; + AC	7 PK 2875 TM
				ALT	MTR-CODE: DOFA;TBE; MOD: 350; - AC	7 PK 2710 TM
				ALT	MTR-CODE: DOFA;TBE; MOD: 350; + AC	7 PK 2875 TM
				ALT	MTR-CODE: TBE; MOD: 410; - AC	7 PK 2710 TM

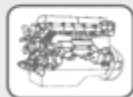

## FORD

### TRANSIT Pritsche/Fahrgestell (FM\_ , FN\_ )

#### 2.4 TDE

2402 ccm	92 kW	DOFA	07.01 - 05.06	ALT	MTR-CODE: TBE; MOD: 410; + AC	7 PK 2875 TM
				ALT	MTR-CODE: TBE; MOD: 425; - AC	7 PK 2710 TM
				ALT	MTR-CODE: TBE; MOD: 425; + AC	7 PK 2875 TM

#### 2.4 TDCi

2402 ccm	101 kW	H9FA	03.04 - 05.06	ALT	MOD: 330; - AC	7 PK 2710 TM
				ALT	MOD: 330; + AC	7 PK 2875 TM
				ALT	MOD: 350; - AC	7 PK 2710 TM
				ALT	MOD: 350; + AC	7 PK 2875 TM
				ALT	MOD: 425; - AC	7 PK 2710 TM
				ALT	MOD: 425; + AC	7 PK 2875 TM
				ALT	MOD: 430; - AC	7 PK 2710 TM
				ALT	MOD: 430; + AC	7 PK 2875 TM

### TRANSIT TOURNEO

#### 2.2 TDCi

2198 ccm	81 kW	QVFA	07.06 -	ALT	- AC	6 EPK 873
				ALT	+ AC	6 PK 1670
				PS		4 EPK 922

#### 2.2 TDCi

2198 ccm	85 kW	SRFA;SRFB;SRFC;SRFD;SRFE	10.08 -	ALT	+ AC	6 PK 1670
----------	-------	--------------------------	---------	-----	------	-----------

#### 2.2 TDCi

2198 ccm	96 kW	QWFA	07.06 -	ALT	- AC	6 EPK 873
				ALT	+ AC	6 PK 1670
				PS		4 EPK 922

#### 2.2 TDCi

2198 ccm	103 kW	PGFA;PGFB	10.07 -	ALT	- AC	6 EPK 873
				ALT	+ AC	6 PK 1670
				PS		4 EPK 922

### TRANSIT Bus

#### 2.2 TDCi

2198 ccm	63 kW	P8FA;P8FB	04.06 -	ALT	- AC	6 EPK 873
				ALT	MTR-CODE: P8FA; + AC	6 PK 1670
				ALT	MTR-CODE: P8FA; MOD: 280; + AC	6 PK 1670
				ALT	MTR-CODE: P8FA; MOD: 300; + AC	6 PK 1670
				ALT	MTR-CODE: P8FA;PGFA;QVFA;QWFA; MOD: 300; + AC	6 PK 1670
				PS		4 EPK 922

#### 2.2 TDCi

2198 ccm	81 kW	QVFA	04.06 -	ALT	- AC	6 EPK 873
				ALT	MTR-CODE: P8FA;PGFA;QVFA;QWFA; MOD: 300; + AC	6 PK 1670
				ALT	MTR-CODE: QVFA; MOD: 280; + AC	6 PK 1670
				ALT	MTR-CODE: QVFA; MOD: 300; + AC	6 PK 1670
				ALT	MTR-CODE: QVFA; MOD: 330; + AC	6 PK 1670
				ALT	MTR-CODE: QVFA; MOD: 350; + AC	6 PK 1670
				PS		4 EPK 922

#### 2.2 TDCi

2198 ccm	85 kW	SRFA;SRFB;SRFC;SRFD;SRFE	10.08 -	ALT	MTR-CODE: P8FA;PGFA;QVFA;QWFA; MOD: 300; + AC	6 PK 1670
				ALT	MTR-CODE: QVFA; MOD: 280; + AC	6 PK 1670
				ALT	MTR-CODE: QVFA; MOD: 300; + AC	6 PK 1670
				ALT	MTR-CODE: QVFA; MOD: 330; + AC	6 PK 1670
				ALT	MTR-CODE: QVFA; MOD: 350; + AC	6 PK 1670

#### 2.2 TDCi

2198 ccm	96 kW	QWFA	04.06 -	ALT	- AC	6 EPK 873
				ALT	MTR-CODE: P8FA;PGFA;QVFA;QWFA; MOD: 300; + AC	6 PK 1670
				ALT	MTR-CODE: QWFA; MOD: 280; + AC	6 PK 1670
				ALT	MTR-CODE: QWFA; MOD: 300; + AC	6 PK 1670
				ALT	MTR-CODE: QWFA; MOD: 330; + AC	6 PK 1670
				ALT	MTR-CODE: QWFA; MOD: 350; + AC	6 PK 1670
				PS		4 EPK 922

#### 2.2 TDCi

2198 ccm	103 kW	PGFA;PGFB;UHFA;UHFB;UHFC	10.07 -	ALT	- AC	6 EPK 873
				ALT	MTR-CODE: P8FA;PGFA;QVFA;QWFA; MOD: 300; + AC	6 PK 1670



## FORD

### TRANSIT Bus

#### 2.2 TDCi

2198 ccm	103 kW	PGFA;PGFB;UHFA;UHFB;UHFC	10.07 -	ALT	MTR-CODE: PGFA; MOD: 280; + AC	6 PK 1670
				ALT	MTR-CODE: PGFA; MOD: 300; + AC	6 PK 1670
				ALT	MTR-CODE: PGFA; MOD: 330; + AC	6 PK 1670
				ALT	MTR-CODE: PGFA; MOD: 350; + AC	6 PK 1670
				PS		4 EPK 922

#### 2.4 TDCi

2402 ccm	74 kW	PHFA;PHFC	04.06 -	ALT	MTR-CODE: PHFA; MOD: 330; + AC	7 PK 2842 TM
				ALT	MTR-CODE: PHFA; MOD: 350; + AC	7 PK 2842 TM
				ALT	MTR-CODE: PHFA; OE-NO.: 6C1Q6C301GB; MOD: 330; - AC	7 PK 2682 TM
				ALT	MTR-CODE: PHFA; OE-NO.: 6C1Q6C301GB; MOD: 350; - AC	7 PK 2682 TM
				ALT	MTR-CODE: PHFA; OE-NO.: YC1E6C301AB/CB; MOD: 330; - AC	7 PK 2710 TM
				ALT	MTR-CODE: PHFA; OE-NO.: YC1E6C301AB/CB; MOD: 350; - AC	7 PK 2710 TM
				ALT	MTR-CODE: PHFA; OE-NO.: YC1E6C301BB/DB; MOD: 330; - AC	7 PK 2875 TM
				ALT	MTR-CODE: PHFA; OE-NO.: YC1E6C301BB/DB; MOD: 350; - AC	7 PK 2875 TM

#### 2.4 TDCi

2402 ccm	85 kW	JXFA;JXFC	04.06 -	ALT	MOD: 330; + AC	7 PK 2842 TM
				ALT	MOD: 350; + AC	7 PK 2842 TM
				ALT	MOD: 430; + AC	7 PK 2842 TM
				ALT	OE-NO.: 6C1Q6C301GB; MOD: 330; - AC	7 PK 2682 TM
				ALT	OE-NO.: 6C1Q6C301GB; MOD: 350; - AC	7 PK 2682 TM
				ALT	OE-NO.: 6C1Q6C301GB; MOD: 430; - AC	7 PK 2682 TM
				ALT	OE-NO.: YC1E6C301AB/CB; MOD: 330; - AC	7 PK 2710 TM
				ALT	OE-NO.: YC1E6C301AB/CB; MOD: 350; - AC	7 PK 2710 TM
				ALT	OE-NO.: YC1E6C301AB/CB; MOD: 430; - AC	7 PK 2710 TM
				ALT	OE-NO.: YC1E6C301BB/DB; MOD: 330; - AC	7 PK 2875 TM
				ALT	OE-NO.: YC1E6C301BB/DB; MOD: 350; - AC	7 PK 2875 TM
				ALT	OE-NO.: YC1E6C301BB/DB; MOD: 430; - AC	7 PK 2875 TM

#### 2.4 TDCi

2402 ccm	103 kW	H9FD	04.06 -	ALT	MTR-CODE: HPFB; MOD: 330; + AC	7 PK 2842 TM
				ALT	MTR-CODE: HPFB; MOD: 350; + AC	7 PK 2842 TM
				ALT	MTR-CODE: HPFB; OE-NO.: 6C1Q6C301GB; MOD: 330; - AC	7 PK 2682 TM
				ALT	MTR-CODE: HPFB; OE-NO.: 6C1Q6C301GB; MOD: 350; - AC	7 PK 2682 TM
				ALT	MTR-CODE: HPFB; OE-NO.: YC1E6C301AB/CB; MOD: 330; - AC	7 PK 2710 TM
				ALT	MTR-CODE: HPFB; OE-NO.: YC1E6C301AB/CB; MOD: 350; - AC	7 PK 2710 TM
				ALT	MTR-CODE: HPFB; OE-NO.: YC1E6C301BB/DB; MOD: 330; - AC	7 PK 2875 TM
				ALT	MTR-CODE: HPFB; OE-NO.: YC1E6C301BB/DB; MOD: 350; - AC	7 PK 2875 TM

#### 2.4 TDCi 4x4

2402 ccm	103 kW	H9FB	11.06 -	ALT	MTR-CODE: HPFB; MOD: 330; + AC	7 PK 2842 TM
				ALT	MTR-CODE: HPFB; MOD: 350; + AC	7 PK 2842 TM
				ALT	MTR-CODE: HPFB; OE-NO.: 6C1Q6C301GB; MOD: 330; - AC	7 PK 2682 TM
				ALT	MTR-CODE: HPFB; OE-NO.: 6C1Q6C301GB; MOD: 350; - AC	7 PK 2682 TM
				ALT	MTR-CODE: HPFB; OE-NO.: YC1E6C301AB/CB; MOD: 330; - AC	7 PK 2710 TM
				ALT	MTR-CODE: HPFB; OE-NO.: YC1E6C301AB/CB; MOD: 350; - AC	7 PK 2710 TM
				ALT	MTR-CODE: HPFB; OE-NO.: YC1E6C301BB/DB; MOD: 330; - AC	7 PK 2875 TM
				ALT	MTR-CODE: HPFB; OE-NO.: YC1E6C301BB/DB; MOD: 350; - AC	7 PK 2875 TM

#### 3.2 TDCi

3199 ccm	147 kW	SAFA;SAFB	02.08 -	ALT	MOD: 350; - AC	7 PK 2682 TM
				ALT	MOD: 350; + AC	7 PK 2842 TM

### TRANSIT Kasten

#### 2.3 16V

2295 ccm	107 kW	GZFA;GZFC	04.06 -	ALT	MTR-CODE: GZFA; MOD: 300; - AC	6 PK 2205
----------	--------	-----------	---------	-----	--------------------------------	-----------





## FORD

### TRANSIT Kasten

#### 2.3 16V

2295 ccm	107 kW	GZFA;GZFC	04.06 -	ALT	MTR-CODE: GZFA; MOD: 330; - AC	<b>6 PK 2205</b>
				ALT	MTR-CODE: GZFA; MOD: 350; - AC	<b>6 PK 2205</b>

#### 2.2 TDCi

2198 ccm	63 kW	P8FA;P8FB	04.06 -	ALT	- AC	<b>6 EPK 873</b>
				ALT	MTR-CODE: P8FA; MOD: 260; + AC	<b>6 PK 1670</b>
				ALT	MTR-CODE: P8FA; MOD: 280; + AC	<b>6 PK 1670</b>
				ALT	MTR-CODE: P8FA; MOD: 300; + AC	<b>6 PK 1670</b>
				ALT	MTR-CODE: P8FA;PGFA;QVFA;QWFA; MOD: 300; + AC	<b>6 PK 1670</b>
				PS		<b>4 EPK 922</b>

#### 2.2 TDCi

2198 ccm	81 kW	QVFA	04.06 -	ALT	- AC	<b>6 EPK 873</b>
				ALT	MTR-CODE: P8FA;PGFA;QVFA;QWFA; MOD: 300; + AC	<b>6 PK 1670</b>
				ALT	MTR-CODE: QVFA; MOD: 260; + AC	<b>6 PK 1670</b>
				ALT	MTR-CODE: QVFA; MOD: 280; + AC	<b>6 PK 1670</b>
				ALT	MTR-CODE: QVFA; MOD: 300; + AC	<b>6 PK 1670</b>
				ALT	MTR-CODE: QVFA; MOD: 330; + AC	<b>6 PK 1670</b>
				ALT	MTR-CODE: QVFA; MOD: 350; + AC	<b>6 PK 1670</b>
				PS		<b>4 EPK 922</b>

#### 2.2 TDCi

2198 ccm	85 kW	SRFA;SRFB;SRFC;SRFD;SRFE	10.08 -	ALT	MTR-CODE: P8FA;PGFA;QVFA;QWFA; MOD: 300; + AC	<b>6 PK 1670</b>
				ALT	MTR-CODE: QVFA; MOD: 260; + AC	<b>6 PK 1670</b>
				ALT	MTR-CODE: QVFA; MOD: 280; + AC	<b>6 PK 1670</b>
				ALT	MTR-CODE: QVFA; MOD: 300; + AC	<b>6 PK 1670</b>
				ALT	MTR-CODE: QVFA; MOD: 330; + AC	<b>6 PK 1670</b>
				ALT	MTR-CODE: QVFA; MOD: 350; + AC	<b>6 PK 1670</b>
				PS		<b>4 EPK 922</b>

#### 2.2 TDCi

2198 ccm	96 kW	QWFA	04.06 -	ALT	- AC	<b>6 EPK 873</b>
				ALT	MTR-CODE: P8FA;PGFA;QVFA;QWFA; MOD: 300; + AC	<b>6 PK 1670</b>
				ALT	MTR-CODE: QWFA; MOD: 260; + AC	<b>6 PK 1670</b>
				ALT	MTR-CODE: QWFA; MOD: 280; + AC	<b>6 PK 1670</b>
				ALT	MTR-CODE: QWFA; MOD: 300; + AC	<b>6 PK 1670</b>
				ALT	MTR-CODE: QWFA; MOD: 330; + AC	<b>6 PK 1670</b>
				ALT	MTR-CODE: QWFA; MOD: 350; + AC	<b>6 PK 1670</b>
				PS		<b>4 EPK 922</b>

#### 2.2 TDCi

2198 ccm	103 kW	PGFA;PGFB;UHFA;UHFB;UHFC	10.07 -	ALT	- AC	<b>6 EPK 873</b>
				ALT	MTR-CODE: P8FA;PGFA;QVFA;QWFA; MOD: 300; + AC	<b>6 PK 1670</b>
				ALT	MTR-CODE: PGFA; MOD: 260; + AC	<b>6 PK 1670</b>
				ALT	MTR-CODE: PGFA; MOD: 280; + AC	<b>6 PK 1670</b>
				ALT	MTR-CODE: PGFA; MOD: 300; + AC	<b>6 PK 1670</b>
				ALT	MTR-CODE: PGFA; MOD: 330; + AC	<b>6 PK 1670</b>
				ALT	MTR-CODE: PGFA; MOD: 350; + AC	<b>6 PK 1670</b>
				PS		<b>4 EPK 922</b>

#### 2.4 TDCi

2402 ccm	74 kW	PHFA;PHFC	04.06 -	ALT	MTR-CODE: PHFA; MOD: 300; + AC	<b>7 PK 2842 TM</b>
				ALT	MTR-CODE: PHFA; MOD: 330; + AC	<b>7 PK 2842 TM</b>
				ALT	MTR-CODE: PHFA; MOD: 350; + AC	<b>7 PK 2842 TM</b>
				ALT	MTR-CODE: PHFA; MOD: 430; + AC	<b>7 PK 2842 TM</b>
				ALT	MTR-CODE: PHFA; OE-NO.: 6C1Q6C301GB; MOD: 300; - AC	<b>7 PK 2682 TM</b>
				ALT	MTR-CODE: PHFA; OE-NO.: 6C1Q6C301GB; MOD: 330; - AC	<b>7 PK 2682 TM</b>
				ALT	MTR-CODE: PHFA; OE-NO.: 6C1Q6C301GB; MOD: 350; - AC	<b>7 PK 2682 TM</b>
				ALT	MTR-CODE: PHFA; OE-NO.: 6C1Q6C301GB; MOD: 430; - AC	<b>7 PK 2682 TM</b>
				ALT	MTR-CODE: PHFA; OE-NO.: YC1E6C301AB/CB; MOD: 300; - AC	<b>7 PK 2710 TM</b>
				ALT	MTR-CODE: PHFA; OE-NO.: YC1E6C301AB/CB; MOD: 330; - AC	<b>7 PK 2710 TM</b>
				ALT	MTR-CODE: PHFA; OE-NO.: YC1E6C301AB/CB; MOD: 350; - AC	<b>7 PK 2710 TM</b>

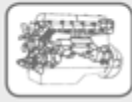

## FORD

### TRANSIT Kasten

#### 2.4 TDCi

2402 ccm	74 kW	PHFA;PHFC	04.06 -	ALT	MTR-CODE: PHFA; OE-NO.: YC1E6C301AB/CB; MOD: 430; - AC	7 PK 2710 TM
				ALT	MTR-CODE: PHFA; OE-NO.: YC1E6C301BB/DB; MOD: 300; - AC	7 PK 2875 TM
				ALT	MTR-CODE: PHFA; OE-NO.: YC1E6C301BB/DB; MOD: 330; - AC	7 PK 2875 TM
				ALT	MTR-CODE: PHFA; OE-NO.: YC1E6C301BB/DB; MOD: 350; - AC	7 PK 2875 TM
				ALT	MTR-CODE: PHFA; OE-NO.: YC1E6C301BB/DB; MOD: 430; - AC	7 PK 2875 TM

#### 2.4 TDCi

2402 ccm	85 kW	JXFA;JXFC	04.06 -	ALT	MOD: 330; + AC	7 PK 2842 TM
				ALT	MOD: 350; + AC	7 PK 2842 TM
				ALT	MOD: 430; + AC	7 PK 2842 TM
				ALT	MOD: 460; + AC	7 PK 2842 TM
				ALT	OE-NO.: 6C1Q6C301GB; MOD: 330; - AC	7 PK 2682 TM
				ALT	OE-NO.: 6C1Q6C301GB; MOD: 350; - AC	7 PK 2682 TM
				ALT	OE-NO.: 6C1Q6C301GB; MOD: 430; - AC	7 PK 2682 TM
				ALT	OE-NO.: 6C1Q6C301GB; MOD: 460; - AC	7 PK 2682 TM
				ALT	OE-NO.: YC1E6C301AB/CB; MOD: 330; - AC	7 PK 2710 TM
				ALT	OE-NO.: YC1E6C301AB/CB; MOD: 350; - AC	7 PK 2710 TM
				ALT	OE-NO.: YC1E6C301AB/CB; MOD: 430; - AC	7 PK 2710 TM
				ALT	OE-NO.: YC1E6C301AB/CB; MOD: 460; - AC	7 PK 2710 TM
				ALT	OE-NO.: YC1E6C301BB/DB; MOD: 330; - AC	7 PK 2875 TM
				ALT	OE-NO.: YC1E6C301BB/DB; MOD: 350; - AC	7 PK 2875 TM
				ALT	OE-NO.: YC1E6C301BB/DB; MOD: 430; - AC	7 PK 2875 TM
				ALT	OE-NO.: YC1E6C301BB/DB; MOD: 460; - AC	7 PK 2875 TM

#### 2.4 TDCi

2402 ccm	103 kW	H9FD	04.06 -	ALT	MTR-CODE: HPFB; MOD: 330; + AC	7 PK 2842 TM
				ALT	MTR-CODE: HPFB; MOD: 350; + AC	7 PK 2842 TM
				ALT	MTR-CODE: HPFB; MOD: 430; + AC	7 PK 2842 TM
				ALT	MTR-CODE: HPFB; MOD: 460; + AC	7 PK 2842 TM
				ALT	MTR-CODE: HPFB; OE-NO.: 6C1Q6C301GB; MOD: 330; - AC	7 PK 2682 TM
				ALT	MTR-CODE: HPFB; OE-NO.: 6C1Q6C301GB; MOD: 350; - AC	7 PK 2682 TM
				ALT	MTR-CODE: HPFB; OE-NO.: 6C1Q6C301GB; MOD: 430; - AC	7 PK 2682 TM
				ALT	MTR-CODE: HPFB; OE-NO.: 6C1Q6C301GB; MOD: 460; - AC	7 PK 2682 TM
				ALT	MTR-CODE: HPFB; OE-NO.: YC1E6C301AB/CB; MOD: 330; - AC	7 PK 2710 TM
				ALT	MTR-CODE: HPFB; OE-NO.: YC1E6C301AB/CB; MOD: 350; - AC	7 PK 2710 TM
				ALT	MTR-CODE: HPFB; OE-NO.: YC1E6C301AB/CB; MOD: 430; - AC	7 PK 2710 TM
				ALT	MTR-CODE: HPFB; OE-NO.: YC1E6C301AB/CB; MOD: 460; - AC	7 PK 2710 TM
				ALT	MTR-CODE: HPFB; OE-NO.: YC1E6C301BB/DB; MOD: 330; - AC	7 PK 2875 TM
				ALT	MTR-CODE: HPFB; OE-NO.: YC1E6C301BB/DB; MOD: 350; - AC	7 PK 2875 TM
				ALT	MTR-CODE: HPFB; OE-NO.: YC1E6C301BB/DB; MOD: 430; - AC	7 PK 2875 TM
				ALT	MTR-CODE: HPFB; OE-NO.: YC1E6C301BB/DB; MOD: 460; - AC	7 PK 2875 TM

#### 2.4 TDCi 4x4

2402 ccm	103 kW	H9FB	11.06 -	ALT	MOD: 350; + AC	7 PK 2842 TM
				ALT	OE-NO.: 6C1Q6C301GB; MOD: 350; - AC	7 PK 2682 TM
				ALT	OE-NO.: YC1E6C301AB/CB; MOD: 350; - AC	7 PK 2710 TM
				ALT	OE-NO.: YC1E6C301BB/DB; MOD: 350; - AC	7 PK 2875 TM

#### 3.2 TDCi

3199 ccm	147 kW	SAFA;SAFB	09.07 -	ALT	MTR-CODE: 32DDOP; MOD: 350; - AC	7 PK 2682 TM
				ALT	MTR-CODE: 32DDOP; MOD: 350; + AC	7 PK 2842 TM
				ALT	MTR-CODE: 32DDOP; MOD: 460; - AC	7 PK 2682 TM
				ALT	MTR-CODE: 32DDOP; MOD: 460; + AC	7 PK 2842 TM

### TRANSIT Pritsche/Fahrgestell

#### 2.3 16V

2295 ccm	107 kW	GZFA;GZFC	04.06 -	ALT	MTR-CODE: GZFB; MOD: 300; - AC	6 PK 2205
----------	--------	-----------	---------	-----	--------------------------------	-----------



## FORD

### TRANSIT Pritsche/Fahrgestell

#### 2.3 16V

2295 ccm	107 kW	GZFA;GZFC	04.06 -	ALT	MTR-CODE: GZFB; MOD: 330; - AC	6 PK 2205
				ALT	MTR-CODE: GZFB; MOD: 350; - AC	6 PK 2205

#### 2.2 TDCi

2198 ccm	63 kW	P8FA;P8FB	04.06 -	ALT	- AC	6 EPK 873
				ALT	MTR-CODE: P8FA; MOD: 300; + AC	6 PK 1670
				ALT	MTR-CODE: P8FA;PGFA;QVFA;QWFA; MOD: 300; + AC	6 PK 1670
				PS		4 EPK 922

#### 2.2 TDCi

2198 ccm	81 kW	QVFA	04.06 -	ALT	- AC	6 EPK 873
				ALT	MTR-CODE: P8FA;PGFA;QVFA;QWFA; MOD: 300; + AC	6 PK 1670
				ALT	MTR-CODE: QVFA; MOD: 300; + AC	6 PK 1670
				ALT	MTR-CODE: QVFA; MOD: 350; + AC	6 PK 1670
				PS		4 EPK 922

#### 2.2 TDCi

2198 ccm	85 kW	SRFA;SRFB;SRFC;SRFD;SRFE	10.08 -	ALT	MTR-CODE: P8FA;PGFA;QVFA;QWFA; MOD: 300; + AC	6 PK 1670
				ALT	MTR-CODE: QVFA; MOD: 300; + AC	6 PK 1670
				ALT	MTR-CODE: QVFA; MOD: 350; + AC	6 PK 1670

#### 2.2 TDCi

2198 ccm	96 kW	QWFA	04.06 -	ALT	- AC	6 EPK 873
				ALT	MTR-CODE: P8FA;PGFA;QVFA;QWFA; MOD: 300; + AC	6 PK 1670
				ALT	MTR-CODE: QWFA; MOD: 300; + AC	6 PK 1670
				ALT	MTR-CODE: QWFA; MOD: 350; + AC	6 PK 1670
				PS		4 EPK 922

#### 2.2 TDCi

2198 ccm	103 kW	PGFA;PGFB;UHFA;UHFB;UHFC	10.07 -	ALT	- AC	6 EPK 873
				ALT	MTR-CODE: P8FA;PGFA;QVFA;QWFA; MOD: 300; + AC	6 PK 1670
				ALT	MTR-CODE: PGFA; MOD: 300; + AC	6 PK 1670
				ALT	MTR-CODE: PGFA; MOD: 350; + AC	6 PK 1670
				PS		4 EPK 922

#### 2.4 TDCi

2402 ccm	74 kW	PHFA;PHFC	04.06 -	ALT	MTR-CODE: PHFA; MOD: 300; + AC	7 PK 2842 TM
				ALT	MTR-CODE: PHFA; MOD: 330; + AC	7 PK 2842 TM
				ALT	MTR-CODE: PHFA; MOD: 350; + AC	7 PK 2842 TM
				ALT	MTR-CODE: PHFA; MOD: 430; + AC	7 PK 2842 TM
				ALT	MTR-CODE: PHFA; OE-NO.: 6C1Q6C301GB; MOD: 300; - AC	7 PK 2682 TM
				ALT	MTR-CODE: PHFA; OE-NO.: 6C1Q6C301GB; MOD: 330; - AC	7 PK 2682 TM
				ALT	MTR-CODE: PHFA; OE-NO.: 6C1Q6C301GB; MOD: 350; - AC	7 PK 2682 TM
				ALT	MTR-CODE: PHFA; OE-NO.: 6C1Q6C301GB; MOD: 430; - AC	7 PK 2682 TM
				ALT	MTR-CODE: PHFA; OE-NO.: YC1E6C301AB/CB; MOD: 300; - AC	7 PK 2710 TM
				ALT	MTR-CODE: PHFA; OE-NO.: YC1E6C301AB/CB; MOD: 330; - AC	7 PK 2710 TM
				ALT	MTR-CODE: PHFA; OE-NO.: YC1E6C301AB/CB; MOD: 350; - AC	7 PK 2710 TM
				ALT	MTR-CODE: PHFA; OE-NO.: YC1E6C301AB/CB; MOD: 430; - AC	7 PK 2710 TM
				ALT	MTR-CODE: PHFA; OE-NO.: YC1E6C301BB/DB; MOD: 300; - AC	7 PK 2875 TM
				ALT	MTR-CODE: PHFA; OE-NO.: YC1E6C301BB/DB; MOD: 330; - AC	7 PK 2875 TM
				ALT	MTR-CODE: PHFA; OE-NO.: YC1E6C301BB/DB; MOD: 350; - AC	7 PK 2875 TM
				ALT	MTR-CODE: PHFA; OE-NO.: YC1E6C301BB/DB; MOD: 430; - AC	7 PK 2875 TM

#### 2.4 TDCi

2402 ccm	85 kW	JXFA;JXFC	04.06 -	ALT	MOD: 330; + AC	7 PK 2842 TM
				ALT	MOD: 350; + AC	7 PK 2842 TM
				ALT	MOD: 430; + AC	7 PK 2842 TM
				ALT	OE-NO.: 6C1Q6C301GB; MOD: 330; - AC	7 PK 2682 TM
				ALT	OE-NO.: 6C1Q6C301GB; MOD: 350; - AC	7 PK 2682 TM



## FORD

### TRANSIT Pritsche/Fahrgestell

#### 2.4 TDCi

2402 ccm	85 kW	JXFA;JXFC	04.06 -	ALT	OE-NO.: 6C1Q6C301GB; MOD: 430; - AC	7 PK 2682 TM
				ALT	OE-NO.: YC1E6C301AB/CB; MOD: 330; - AC	7 PK 2710 TM
				ALT	OE-NO.: YC1E6C301AB/CB; MOD: 350; - AC	7 PK 2710 TM
				ALT	OE-NO.: YC1E6C301AB/CB; MOD: 430; - AC	7 PK 2710 TM
				ALT	OE-NO.: YC1E6C301BB/DB; MOD: 330; - AC	7 PK 2875 TM
				ALT	OE-NO.: YC1E6C301BB/DB; MOD: 350; - AC	7 PK 2875 TM
				ALT	OE-NO.: YC1E6C301BB/DB; MOD: 430; - AC	7 PK 2875 TM

#### 2.4 TDCi

2402 ccm	103 kW	H9FD	04.06 -	ALT	MTR-CODE: HPFB; MOD: 330; + AC	7 PK 2842 TM
				ALT	MTR-CODE: HPFB; MOD: 350; + AC	7 PK 2842 TM
				ALT	MTR-CODE: HPFB; MOD: 460; + AC	7 PK 2842 TM
				ALT	MTR-CODE: HPFB; OE-NO.: 6C1Q6C301GB; MOD: 330; - AC	7 PK 2682 TM
				ALT	MTR-CODE: HPFB; OE-NO.: 6C1Q6C301GB; MOD: 350; - AC	7 PK 2682 TM
				ALT	MTR-CODE: HPFB; OE-NO.: 6C1Q6C301GB; MOD: 460; - AC	7 PK 2682 TM
				ALT	MTR-CODE: HPFB; OE-NO.: YC1E6C301AB/CB; MOD: 330; - AC	7 PK 2710 TM
				ALT	MTR-CODE: HPFB; OE-NO.: YC1E6C301AB/CB; MOD: 350; - AC	7 PK 2710 TM
				ALT	MTR-CODE: HPFB; OE-NO.: YC1E6C301AB/CB; MOD: 460; - AC	7 PK 2710 TM
				ALT	MTR-CODE: HPFB; OE-NO.: YC1E6C301BB/DB; MOD: 330; - AC	7 PK 2875 TM
				ALT	MTR-CODE: HPFB; OE-NO.: YC1E6C301BB/DB; MOD: 350; - AC	7 PK 2875 TM
				ALT	MTR-CODE: HPFB; OE-NO.: YC1E6C301BB/DB; MOD: 460; - AC	7 PK 2875 TM

#### 2.4 TDCi 4x4

2402 ccm	103 kW	H9FB	11.06 -	ALT	MOD: 350; + AC	7 PK 2842 TM
				ALT	OE-NO.: 6C1Q6C301GB; MOD: 350; - AC	7 PK 2682 TM
				ALT	OE-NO.: YC1E6C301AB/CB; MOD: 350; - AC	7 PK 2710 TM
				ALT	OE-NO.: YC1E6C301BB/DB; MOD: 350; - AC	7 PK 2875 TM

#### 3.2 TDCi

3199 ccm	147 kW	SAFA;SAFB	09.07 -	ALT	FROM: 02.08; MTR-CODE: 32DDOP; MOD: 430; + AC	7 PK 2842 TM
				ALT	FROM: 02.08; MTR-CODE: 32DDOP; OE-NO.: 6C1Q6C301GB; MOD: 430; - AC	7 PK 2682 TM
				ALT	MTR-CODE: 32DDOP; MOD: 350; - AC	7 PK 2682 TM
				ALT	MTR-CODE: 32DDOP; MOD: 350; + AC	7 PK 2842 TM
				ALT	MTR-CODE: 32DDOP; MOD: 460; - AC	7 PK 2682 TM
				ALT	MTR-CODE: 32DDOP; MOD: 460; + AC	7 PK 2842 TM

## FORD AUSTRALIA

### COURIER Pick-up (PC)

#### 2.0

1998 ccm	84 kW	FE	06.85 - 12.89		+ AC	13A 940
				ALT		13A 980
				CAM	FROM: 01.88	ZRK 1167
				CAM	UNTIL: 12.87	ZRK 1335

#### 2.0

1998 ccm	92 kW	FE	12.89 - 12.92		+ AC	13A 940
				ALT		13A 980
				CAM		ZRK 1167

#### 2.2

2184 ccm	68 kW	F2 (12 V)	01.89 - 06.93		+ AC	13A 915
				ALT		13A 990
				CAM		ZRK 1168

#### 2.6 i

2606 ccm	92 kW	G6	10.91 - 04.96		+ PS	13A 940
				- TEN-PUL	+ AC	13A 1090
				ALT		13A 1065
				TENS-PUL	+ AC	13A 1195

#### 2.6 i 4x4

2606 ccm	92 kW	G6	10.90 - 04.96		+ PS	13A 940
				- TEN-PUL	+ AC	13A 1090

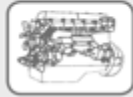

## FORD AUSTRALIA

### COURIER Pick-up (PC)

#### 2.6 i 4x4

2606 ccm	92 kW	G6	10.90 - 04.96	ALT		13A 1065
				TENS-PUL	+ AC	13A 1195

#### 2.2 D

2184 ccm	47 kW	R2	06.85 - 04.96		+ AC	13A 915
				ALT		13A 1120
				CAM	FROM: 07.87	ZRK 1264

### COURIER Pritsche/Fahrgestell (PC)

#### 2.0

1998 ccm	84 kW	FE	01.88 - 12.89		+ AC	13A 940
				ALT		13A 980
				CAM		ZRK 1167

#### 2.0

1998 ccm	92 kW	FE	12.89 - 12.92		+ AC	13A 940
				ALT		13A 980
				CAM		ZRK 1167

#### 2.2

2184 ccm	68 kW	F2 (12 V)	01.89 - 06.93		+ AC	13A 915
				ALT		13A 990
				CAM		ZRK 1168

#### 2.6 i

2606 ccm	92 kW	G6	10.91 - 04.96		+ PS	13A 940
				- TEN-PUL	+ AC	13A 1090
				ALT		13A 1065
				TENS-PUL	+ AC	13A 1195

#### 2.6 i 4x4

2606 ccm	92 kW	G6	10.91 - 04.96		+ PS	13A 940
				- TEN-PUL	+ AC	13A 1090
				ALT		13A 1065
				TENS-PUL	+ AC	13A 1195

#### 2.2 D

2184 ccm	47 kW	R2	01.88 - 04.96		+ AC	13A 915
				ALT		13A 1120
				CAM		ZRK 1264

### COURIER Pick-up (PD)

#### 2.6 i

2606 ccm	92 kW	G6	05.96 - 02.99		+ PS	13A 940
				- TEN-PUL	+ AC	13A 1090
				ALT		13A 1065
				TENS-PUL	+ AC	13A 1195

#### 2.6 i 4x4

2606 ccm	92 kW	G6	05.96 - 02.99		+ PS	13A 940
				- TEN-PUL	+ AC	13A 1090
				ALT		13A 1065
				TENS-PUL	+ AC	13A 1195

#### 2.5 D

2500 ccm	63 kW	WL	05.96 - 02.99		+ AC	13A 1030
				ALT	QTY: 2	13A 1100
				CAM		ZRK 1393

#### 2.5 D Allrad

2500 ccm	63 kW	WL	05.96 - 02.99		+ AC	13A 1030
				ALT	QTY: 2	13A 1100
				CAM		ZRK 1393

### COURIER Pritsche/Fahrgestell (PD)

#### 2.6 i

2606 ccm	92 kW	G6	05.96 - 02.99		+ PS	13A 940
				- TEN-PUL	+ AC	13A 1090
				ALT		13A 1065
				TENS-PUL	+ AC	13A 1195

#### 2.6 i 4x4

2606 ccm	92 kW	G6	05.96 - 02.99		+ PS	13A 940
				- TEN-PUL	+ AC	13A 1090
				ALT		13A 1065
				TENS-PUL	+ AC	13A 1195



## FORD AUSTRALIA

### COURIER Pritsche/Fahrgestell (PD)

2.5 D							
2500 ccm	64 kW	WL	05.96 - 02.99		+ AC		13A 1030
				ALT	QTY: 2		13A 1100
				CAM			ZRK 1393
2.5 D 4x4							
2500 ccm	64 kW	WL	05.96 - 02.99		+ AC		13A 1030
				ALT	QTY: 2		13A 1100
				CAM			ZRK 1393

### COURIER Pick-up (PE)

2.6 i							
2606 ccm	92 kW	G6	02.99 - 11.02		+ PS		13A 940
				- TEN-PUL	+ AC		13A 1090
				ALT			13A 1065
				TENS-PUL	+ AC		13A 1195
2.6 i 4x4							
2606 ccm	92 kW	G6	02.99 - 11.02		+ PS		13A 940
				- TEN-PUL	+ AC		13A 1090
				ALT			13A 1065
				TENS-PUL	+ AC		13A 1195
2.5 TD							
2500 ccm	86 kW	WLAT (12 V)	02.99 - 11.02		+ AC		13A 1030
				ALT	QTY: 2		13A 1100
				CAM			ZRK 1393
2.5 TD 4x4							
2500 ccm	86 kW	WLAT (12 V)	02.99 - 11.02		+ AC		13A 1030
				ALT	QTY: 2		13A 1100
				CAM			ZRK 1393

### COURIER Pritsche/Fahrgestell (PE)

2.6 i							
2606 ccm	92 kW	G6	02.99 - 11.02		+ PS		13A 940
				- TEN-PUL	+ AC		13A 1090
				ALT			13A 1065
				TENS-PUL	+ AC		13A 1195
2.6 i 4x4							
2606 ccm	92 kW	G6	02.99 - 11.02		+ PS		13A 940
				- TEN-PUL	+ AC		13A 1090
				ALT			13A 1065
				TENS-PUL	+ AC		13A 1195
2.5 TD							
2500 ccm	86 kW	WLAT (12 V)	02.99 - 11.02		+ AC		13A 1030
				ALT	QTY: 2		13A 1100
				CAM			ZRK 1393
2.5 TD 4x4							
2500 ccm	86 kW	WLAT (12 V)	02.99 - 11.02		+ AC		13A 1030
				ALT	QTY: 2		13A 1100
				CAM			ZRK 1393

### COURIER Pick-up (PG)

2.6 i							
2606 ccm	92 kW	G6	11.02 - 07.04		+ PS		13A 940
				- TEN-PUL	+ AC		13A 1090
				ALT			13A 1065
				TENS-PUL	+ AC		13A 1195
2.6 i 4x4							
2606 ccm	92 kW	G6	11.02 - 07.04		+ PS		13A 940
				- TEN-PUL	+ AC		13A 1090
				ALT			13A 1065
				TENS-PUL	+ AC		13A 1195
2.5 TD							
2500 ccm	86 kW	WLAT (12 V)	11.02 - 07.04		+ AC		13A 1030
				ALT	QTY: 2		13A 1100
				CAM			ZRK 1393
2.5 TD 4x4							
2500 ccm	86 kW	WLAT (12 V)	11.02 - 07.04		+ AC		13A 1030
				ALT	QTY: 2		13A 1100



## FORD AUSTRALIA

### COURIER Pick-up (PG)

#### 2.5 TD 4x4

2500 ccm	86 kW	WLAT (12 V)	11.02 - 07.04	CAM		ZRK 1393
----------	-------	-------------	---------------	-----	--	----------

### COURIER Pritsche/Fahrgestell (PG)

#### 2.6 i

2606 ccm	92 kW	G6	11.02 - 07.04		+ PS	13A 940
				- TEN-PUL	+ AC	13A 1090
				ALT		13A 1065
				TENS-PUL	+ AC	13A 1195

#### 2.6 i 4x4

2606 ccm	92 kW	G6	11.02 - 07.04		+ PS	13A 940
				- TEN-PUL	+ AC	13A 1090
				ALT		13A 1065
				TENS-PUL	+ AC	13A 1195

#### 2.5 TD

2500 ccm	86 kW	WLAT (12 V)	11.02 - 07.04		+ AC	13A 1030
				ALT	QTY: 2	13A 1100
				CAM		ZRK 1393

#### 2.5 TD 4x4

2500 ccm	86 kW	WLAT (12 V)	11.02 - 07.04		+ AC	13A 1030
				ALT	QTY: 2	13A 1100
				CAM		ZRK 1393

### COURIER Pick-up (PH)

#### 2.6 i

2606 ccm	92 kW	G6	08.04 - 02.06		+ PS	13A 940
				- TEN-PUL	+ AC	13A 1090
				ALT		13A 1065
				TENS-PUL	+ AC	13A 1195

#### 2.6 Allrad

2606 ccm	92 kW	G6	08.04 - 02.06		+ PS	13A 940
				- TEN-PUL	+ AC	13A 1090
				ALT		13A 1065
				TENS-PUL	+ AC	13A 1195

#### 2.5 TD

2500 ccm	86 kW	WLAT (12 V)	08.04 - 12.06		+ AC	13A 1030
				ALT	QTY: 2	13A 1100
				CAM		ZRK 1393

#### 2.5 TD Allrad

2500 ccm	86 kW	WLAT (12 V)	08.04 - 12.06		+ AC	13A 1030
				ALT	QTY: 2	13A 1100
				CAM		ZRK 1393

### COURIER Pritsche/Fahrgestell (PH)

#### 2.6 i

2606 ccm	92 kW	G6	08.04 -		+ PS	13A 940
				- TEN-PUL	+ AC	13A 1090
				ALT		13A 1065
				TENS-PUL	+ AC	13A 1195

#### 2.6 i 4x4

2606 ccm	92 kW	G6	08.04 -		+ PS	13A 940
				- TEN-PUL	+ AC	13A 1090
				ALT		13A 1065
				TENS-PUL	+ AC	13A 1195

#### 2.5 TD

2500 ccm	86 kW	WLAT (12 V)	08.04 -		+ AC	13A 1030
				ALT	QTY: 2	13A 1100
				CAM		ZRK 1393

#### 2.5 TD 4x4

2500 ccm	86 kW	WLT	08.04 -		+ AC	13A 1030
				ALT	QTY: 2	13A 1100
				CAM		ZRK 1393

### ECONOVAN Kasten (JG)

#### 2.0

1998 ccm	63 kW	FE	06.97 - 01.00		+ PS	13A 760
				ALT	- AC	13A 990
				ALT	+ AC	13A 940



## FORD AUSTRALIA

### ECONOVAN Kasten (JG)

<b>2.0</b>						
1998 ccm	63 kW	FE	06.97 - 01.00		+ AC	4 PK 1145
				CAM		ZRK 1167

### ECONOVAN Pritsche/Fahrgestell (JG)

<b>2.0</b>						
1998 ccm	63 kW	FE	06.97 - 01.00		+ PS	13A 760
				ALT	- AC	13A 990
				ALT	+ AC	13A 940
					+ AC	4 PK 1145
				CAM		ZRK 1167

### ECONOVAN Kasten (JH)

<b>1.8 i</b>						
1789 ccm	67 kW	F8 (8 V)	03.03 - 07.06		+ AC	13A 965
					+ PS	13A 775
				ALT		13A 940
					+ AC	4 PK 1145
				CAM		ZRK 1162

<b>2.0</b>						
1998 ccm	63 kW	FE	01.00 - 02.03		+ PS	13A 760
				ALT	- AC	13A 990
				ALT	+ AC	13A 940
					+ AC	4 PK 1145
				CAM		ZRK 1167

<b>2.0 i</b>						
1998 ccm	71 kW	FE	03.03 - 07.06		+ PS	13A 760
				ALT	- AC	13A 990
				ALT	+ AC	13A 940
					+ AC	4 PK 1145
				CAM		ZRK 1167

### FALCON Pritsche/Fahrgestell (AU)

<b>4.0 i</b>						
3984 ccm	157 kW	YTR	07.00 - 09.02	ALT	MTR-TYP: NOT VCT	6 PK 2373
				ALT	MTR-TYP: VCT	6 PK 2510

<b>4.0 i XR6</b>						
3984 ccm	164 kW		07.99 - 09.02	ALT	MTR-TYP: NOT VCT	6 PK 2373
				ALT	MTR-TYP: VCT	6 PK 2510

<b>4.0 i XR6</b>						
3984 ccm	172 kW		02.02 - 09.02	ALT	MTR-TYP: NOT VCT	6 PK 2373
				ALT	MTR-TYP: VCT	6 PK 2510

<b>5.0 i V8</b>						
4942 ccm	175 kW	MNJ	07.99 - 09.02	ALT		6 PK 2415

### FALCON Pritsche/Fahrgestell (BA)

<b>4.0 i</b>						
3984 ccm	182 kW	BARRA 182	09.02 - 09.05	ALT		6 PK 2218

<b>4.0 i Turbo</b>						
3984 ccm	220 kW	BARRA 245T	09.02 - 09.05	ALT		6 PK 2218

### FALCON Pritsche/Fahrgestell (BF)

<b>4.0 i</b>						
3984 ccm	190 kW	BARRA 190	10.05 - 04.08	ALT		6 PK 2230

<b>5.4 i V8</b>						
5408 ccm	220 kW	BARRA 220	10.05 - 01.08	ALT		6 PK 2535

### FALCON Pick-up (FG)

<b>4.0 i R6(Inc XR6)</b>						
3984 ccm	195 kW	BARRA 195	02.08 -	ALT		6 PK 2230

<b>4.0 i Turbo (Inc XR6)</b>						
3984 ccm	270 kW	BARRA 270T	02.08 -	ALT		6 PK 2230

<b>5.4 i V8 XR8</b>						
5408 ccm	290 kW	Boss 290	02.08 -	ALT		6 PK 2535

### FALCON Pritsche/Fahrgestell (FG)

<b>4.0 i</b>						
3984 ccm	195 kW	BARRA 195	02.08 -	ALT		6 PK 2230





## FORD AUSTRALIA

### RANGER Pick-up (PJ)

<b>3.0</b>						
2953 ccm	115 kW	WEAT	11.06 - 03.09		+ AC	13A 980
				ALT	QTY: 2	13A 1100

#### 3.0 Allrad

2953 ccm	115 kW	WEAT	11.06 - 03.09		+ AC	13A 980
				ALT	QTY: 2	13A 1100

#### 2.5 TDdi

2500 ccm	105 kW	WLAT (16 V)	11.06 - 03.09		+ AC	13A 980
				ALT	QTY: 2	13A 1100

#### 2.5 TDdi Allrad

2500 ccm	105 kW	WLAT (16 V)	11.06 - 03.09		+ AC	13A 980
				ALT	QTY: 2	13A 1100

### RANGER Pritsche/Fahrgestell (PJ)

#### 2.5 TDdi

2500 ccm	105 kW	WLAT (16 V)	11.06 - 03.09		+ AC	13A 980
				ALT	QTY: 2	13A 1100

### RANGER Pick-up (PK)

#### 2.5 TDdi

2500 ccm	105 kW	WLAT (16 V)	03.09 - 11.11		+ AC	13A 980
				ALT	QTY: 2	13A 1100

#### 3.0 TDdi 4x4

2953 ccm	115 kW	WEAT	03.09 - 11.11		+ AC	13A 980
				ALT	QTY: 2	13A 1100

### RANGER Pritsche/Fahrgestell (PK)

#### 2.5 TDdi 4x4

2500 ccm	105 kW	WLAT (16 V)	03.09 - 11.11		+ AC	13A 980
				ALT	QTY: 2	13A 1100

#### 3.0 TDdi

2953 ccm	115 kW	WEAT	03.09 - 11.11		+ AC	13A 980
				ALT	QTY: 2	13A 1100

### TRANSIT Bus (VF, VG)

#### 2.0

1998 ccm	84 kW	NSF;NSG	09.95 - 03.00	ALT		6 PK 1415
				ALT	+ AC; + PS	6 PK 1775
				ALT	+ AC; + PS	6 PK 1980

#### 2.0

1998 ccm	84 kW	NSF	06.94 - 03.00	ALT		6 PK 1415
				ALT	+ AC; + PS	6 PK 1775
				ALT	+ AC; + PS	6 PK 1980

#### 2.5

2496 ccm	55 kW	4HC	08.94 - 06.00		+ PS; FROM: 10.96	13A 980
					+ PS; UNTIL: 10.96	13A 1030
				ALT	+ AC; + PS	6 PK 1420
						4 PK 1510

#### 2.5

2496 ccm	63 kW	4GF	01.95 - 03.00		+ PS; FROM: 10.96	13A 980
					+ PS; UNTIL: 10.96	13A 1030
				ALT	+ AC; + PS	6 PK 1420
						4 PK 1485

#### 2.5

2496 ccm	74 kW	4EB	07.94 - 03.00		+ PS; FROM: 10.96	13A 980
					+ PS; UNTIL: 10.96	13A 1030
				ALT	+ AC; + PS	6 PK 1420
						4 PK 1485

#### 2.5

2496 ccm	85 kW	4ED	08.97 - 03.00		+ PS	13A 980
				ALT	+ AC; + PS	6 PK 1420
						4 PK 1485

### TRANSIT Pritsche/Fahrgestell (VF, VG)

#### 2.0

1998 ccm	84 kW	NSF;NSG	08.94 - 03.00	ALT		6 PK 1415
				ALT	+ AC; + PS	6 PK 1775
				ALT	+ AC; + PS	6 PK 1980



## FORD AUSTRALIA

### TRANSIT Pritsche/Fahrgestell (VF, VG)

#### 2.5

2496 ccm	52 kW	4FB	08.94 - 03.00		+ PS; FROM: 10.96 + PS; UNTIL: 10.96 + AC; + PS	13A 980 13A 1030 6 PK 1420 4 PK 1510
				ALT		

#### 2.5

2496 ccm	55 kW	4HC	10.98 - 03.00		+ PS + PS + AC; + PS	13A 1030 13A 980 6 PK 1420 4 PK 1510
				ALT		

#### 2.5

2496 ccm	56 kW	4HB	08.94 - 03.00		+ PS; FROM: 10.96 + PS; UNTIL: 10.96 + AC; + PS	13A 980 13A 1030 6 PK 1420 4 PK 1510
				ALT		

#### 2.5

2496 ccm	63 kW	4GF	08.94 - 03.00		+ PS + PS; FROM: 10.96 + AC; + PS	13A 1030 13A 980 6 PK 1420 4 PK 1485
				ALT		

#### 2.5

2496 ccm	74 kW	4EB	08.94 - 03.00		+ PS; FROM: 10.96 + PS; UNTIL: 10.96 + AC; + PS	13A 980 13A 1030 6 PK 1420 4 PK 1485
				ALT		

#### 2.5

2496 ccm	85 kW	4ED	05.99 - 03.00		+ PS + AC; + PS	13A 980 6 PK 1420 4 PK 1485
				ALT		

### TRANSIT Bus (VH, VJ)

#### 2.3

2295 ccm	107 kW	E5FA;E5FC	08.00 - 09.06	ALT	- AC	6 PK 1775
				ALT	+ AC	6 PK 1955

#### 2.4 D

2402 ccm	55 kW	F4FA	01.00 - 09.06	ALT		7 PK 2875 TM
----------	-------	------	---------------	-----	--	--------------

#### 2.4 D

2402 ccm	66 kW	D2FA	01.00 - 09.06	ALT		7 PK 2875 TM
----------	-------	------	---------------	-----	--	--------------

#### 2.4 D

2402 ccm	85 kW	FXFA	03.04 - 09.06	ALT		7 PK 2875 TM
----------	-------	------	---------------	-----	--	--------------

#### 2.4 D

2402 ccm	88 kW		01.00 - 09.06	ALT		7 PK 2875 TM
----------	-------	--	---------------	-----	--	--------------

#### 2.4 D

2402 ccm	92 kW	DOFA	07.01 - 09.06	ALT		7 PK 2875 TM
----------	-------	------	---------------	-----	--	--------------

#### 2.4 D

2402 ccm	101 kW	H9FA	03.04 - 09.06	ALT		7 PK 2875 TM
----------	--------	------	---------------	-----	--	--------------

### TRANSIT Pritsche/Fahrgestell (VH, VJ)

#### 2.4 D

2402 ccm	55 kW	F4FA	01.00 - 09.06	ALT		7 PK 2875 TM
----------	-------	------	---------------	-----	--	--------------

#### 2.4 D

2402 ccm	66 kW	D2FA	01.00 - 09.06	ALT		7 PK 2875 TM
----------	-------	------	---------------	-----	--	--------------

#### 2.4 D

2402 ccm	85 kW	FXFA	03.04 - 07.06	ALT		7 PK 2875 TM
----------	-------	------	---------------	-----	--	--------------

#### 2.4 D

2402 ccm	88 kW	D4FA	08.00 - 08.03	ALT		7 PK 2875 TM
----------	-------	------	---------------	-----	--	--------------

#### 2.4 D

2402 ccm	88 kW	D4FA	01.00 - 09.06	ALT		7 PK 2875 TM
----------	-------	------	---------------	-----	--	--------------

#### 2.4 D

2402 ccm	92 kW	DOFA	07.01 - 09.06	ALT		7 PK 2875 TM
----------	-------	------	---------------	-----	--	--------------

#### 2.4 D

2402 ccm	101 kW	H9FA	03.04 - 09.06	ALT		7 PK 2875 TM
----------	--------	------	---------------	-----	--	--------------

### TRANSIT Bus (VM)

#### 2.4 D

2402 ccm	74 kW	PHFC	07.06 -	ALT		7 PK 2842 TM
----------	-------	------	---------	-----	--	--------------

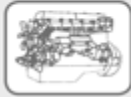

## FORD AUSTRALIA

### TRANSIT Bus (VM)

#### 2.4 D

2402 ccm 85 kW JXFA 07.06 - ALT 7 PK 2842 TM

#### 2.4 TD

2402 ccm 103 kW H9FB 07.06 - ALT 7 PK 2842 TM

#### 2.4 TD Allrad

2402 ccm 103 kW H9FB 11.06 - ALT 7 PK 2842 TM  
ALT 7 PK 2875 TM

### TRANSIT Kasten (VM)

#### 2.3 i

2261 ccm 104 kW 09.06 - ALT 6 PK 2275

#### 2.2 TD

2198 ccm 81 kW QVFA 09.06 - ALT + PS 4 EPK 922  
ALT 6 PK 1675  
ALT + AC 6 PK 1970

#### 2.4 D

2402 ccm 74 kW PHFC 07.06 - ALT 7 PK 2842 TM

#### 2.4 D

2402 ccm 85 kW FXFA 07.06 - ALT 7 PK 2842 TM

#### 2.4 TD

2402 ccm 103 kW H9FB 07.06 - ALT 7 PK 2842 TM

#### 2.4 TD Allrad

2402 ccm 103 kW H9FB 11.06 - ALT 7 PK 2842 TM  
ALT 7 PK 2875 TM

### TRANSIT Pritsche/Fahrgestell (VM)

#### 2.4 D

2402 ccm 74 kW PHFC 07.06 - ALT 7 PK 2842 TM

#### 2.4 D

2402 ccm 85 kW JXFA 07.06 - ALT 7 PK 2842 TM

#### 2.4 TD

2402 ccm 103 kW H9FB 07.06 - ALT 7 PK 2842 TM

#### 2.4 TD Allrad

2402 ccm 103 kW H9FB 11.06 - ALT 7 PK 2842 TM  
ALT 7 PK 2875 TM

## HOLDEN

### COLORADO Pick-up (RC)

#### 3.6 i V6

3565 ccm 157 kW 03.08 - 06.12 ALT 6 PK 1120

#### 3.0 TD

2999 ccm 120 kW 4JJ1-TC 03.08 - 06.12 ALT + AC 13A 1370  
ALT 7 PK 990

#### 3.0 TD 4x4

2999 ccm 120 kW 4JJ1-TC 03.08 - 06.12 ALT + AC 13A 1370  
ALT 7 PK 990

### COLORADO Pritsche/Fahrgestell (RC)

#### 3.6 i V6

3565 ccm 157 kW 03.08 - 06.12 ALT 6 PK 1120

#### 3.0 TD

2999 ccm 120 kW 4JJ1-TC 03.08 - 06.12 ALT + AC 13A 1370  
ALT 7 PK 990

#### 3.0 TD 4x4

2999 ccm 120 kW 4JJ1-TC 03.08 - 06.12 ALT + AC 13A 1370  
ALT 7 PK 990

### ONE TONNER Pritsche/Fahrgestell (VY)

#### 3.8 i V6

3791 ccm 152 kW 06.03 - 12.04 ALT - AC 6 PK 2230  
ALT + AC; FROM CHA-NO.: L661776 6 PK 2825  
ALT + AC; UNTIL CHA-NO.: L661776 6 PK 2805

#### 3.6

3565 ccm 175 kW HB 08.03 - 07.04 ALT 6 PK 2550

#### 5.7

5665 ccm 235 kW LS1 08.03 - 07.04 + AC 4 PK 1100



## HOLDEN

### ONE TONNER Pritsche/Fahrgestell (VY)

<b>5.7</b>	5665 ccm	235 kW	LS1	08.03 - 07.04	ALT		<b>6 PK 2000</b>
------------	----------	--------	-----	---------------	-----	--	------------------

### ONE TONNER Pritsche/Fahrgestell (VZ)

<b>3.6</b>	3565 ccm	175 kW	HB	11.04 - 12.05	ALT		<b>6 PK 2550</b>
<b>3.6 Allrad</b>	3565 ccm	175 kW	HB	11.04 - 12.05	ALT		<b>6 PK 2550</b>
<b>5.7</b>	5665 ccm	235 kW	LS1	11.04 - 12.05		+ AC	<b>4 PK 1100</b>
					ALT	VIN: 491216	<b>6 PK 1970</b>
					ALT	VIN: 491217	<b>6 PK 2000</b>

### RODEO Pick-up (TF)

#### 2.2 i (TFR30, TFR25)

2198 ccm	87 kW	C 22 NE	06.98 - 02.03			+ AC	<b>13A 915</b>
						+ PS	<b>13A 965</b>
				ALT			<b>11A 1040</b>

#### 2.3 i (TFR16)

2254 ccm	69 kW	4ZD1	06.91 - 08.03			+ AC	<b>AVX 10 x 763</b>
						+ PS	<b>13A 1015</b>
				ALT			<b>13A 875</b>

#### 2.6 i (TFR17)

2559 ccm	88 kW	4ZE1	02.88 - 06.98			+ AC	<b>13A 1005</b>
						+ PS	<b>13A 1015</b>
				ALT			<b>13A 890</b>

#### 2.6 i 4x4 (TFS17)

2559 ccm	88 kW	4ZE1	02.88 - 06.98			+ AC	<b>13A 1005</b>
						+ PS	<b>13A 1015</b>
				ALT			<b>13A 890</b>

#### 3.2 i (TFR25)

3165 ccm	140 kW	6VD1	02.98 - 02.03	ALT		- AC	<b>6 PK 2050</b>
				ALT		+ AC	<b>6 PK 2300</b>

#### 3.2 4x4 (TFS25)

3165 ccm	140 kW	6VD1	02.98 - 02.03	ALT		- AC	<b>6 PK 2050</b>
				ALT		+ AC	<b>6 PK 2300</b>

#### 2.5 D (TFR54)

2499 ccm	57 kW	4JA1	02.88 - 12.92			+ AC	<b>AVX 13 x 1550</b>
						+ PS	<b>AVX 13 x 1443</b>
				ALT			<b>15A 1030</b>

#### 2.5 D 4x4 (TFS54)

2499 ccm	57 kW	4JA1	02.88 - 12.92			+ AC	<b>AVX 13 x 1550</b>
						+ PS	<b>AVX 13 x 1443</b>
				ALT			<b>15A 1030</b>

#### 2.8 TD (TFR55)

2771 ccm	74 kW	4JB1-T	05.90 - 02.03			+ AC; QTY: 2	<b>13A 1525</b>
				ALT			<b>15A 1030</b>
				CAM			<b>ZRK 1097</b>

#### 2.8 TD 4x4 (TFS55)

2771 ccm	74 kW	4JB1-T	05.90 - 02.03			+ AC; QTY: 2	<b>13A 1525</b>
				ALT			<b>15A 1030</b>
				CAM			<b>ZRK 1097</b>

#### 3.0 TD 4x4 (TFS77)

2999 ccm	96 kW	4JH1-TC	12.01 - 02.03			+ AC; QTY: 2	<b>AVX 13 x 1562</b>
				ALT			<b>13A 1040</b>

### RODEO Pritsche/Fahrgestell (TF)

#### 2.6 i (TFR17)

2559 ccm	88 kW	4ZE1	02.88 - 02.98			+ AC	<b>13A 1005</b>
						+ PS	<b>13A 1015</b>
				ALT			<b>13A 890</b>

#### 2.6 i 4x4 (TFS17)

2559 ccm	88 kW	4ZE1	02.88 - 06.98			+ AC	<b>13A 1005</b>
						+ PS	<b>13A 1015</b>
				ALT			<b>13A 890</b>

#### 3.2 i (TFR25)

3165 ccm	140 kW	6VD1	02.98 - 02.03	ALT		- AC	<b>6 PK 2050</b>
----------	--------	------	---------------	-----	--	------	------------------

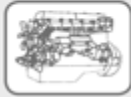

## HOLDEN

### RODEO Pritsche/Fahrgestell (TF)

#### 3.2 i (TFR25)

3165 ccm 140 kW 6VD1 02.98 - 02.03 ALT + AC 6 PK 2300

#### 3.2 i 4x4 (TFS25)

3165 ccm 140 kW 6VD1 03.98 - 02.03 ALT - AC 6 PK 2050  
ALT + AC 6 PK 2300

#### 2.8 TD (TFR55)

2771 ccm 74 kW 4JB1-T 05.90 - 02.03 + AC; QTY: 2 13A 1525  
ALT 15A 1030  
CAM ZRK 1097

### RODEO Pick-up (RA)

#### 2.4 i (TFR32)

2405 ccm 94 kW C 24 SE 02.03 - 07.08 + AC 13A 915  
+ PS 13A 965  
ALT 11A 1040

#### 3.5 i 4x4 (TFS26)

3494 ccm 147 kW 6VE1 02.03 - 12.05 ALT 6 PK 2300

#### 3.5 i (TFS26)

3494 ccm 147 kW 6VE1 02.03 - 12.05 ALT 6 PK 2300

#### 3.6 i (TFS27)

3565 ccm 157 kW 01.06 - 06.08 ALT 6 PK 1120

#### 3.6 i 4x4 (TFS27)

3565 ccm 157 kW 01.06 - 06.08 ALT 6 PK 1120

#### 3.0 TD (TFR77)

2999 ccm 96 kW 4JH1-TC 02.03 - 01.07 + AC; QTY: 2 AVX 13 x 1562  
ALT 13A 1030

#### 3.0 TD 4x4 (TFS77)

2999 ccm 96 kW 4JH1-TC 02.03 - 01.07 + AC; QTY: 2 AVX 13 x 1562  
ALT 13A 1030

#### 3.0 DiTD (TFR77)

2999 ccm 117 kW 4JJ1-TC 01.07 - 10.08 + AC; QTY: 2 AVX 13 x 1562  
ALT 13A 1030

#### 3.0 DiTD 4x4 (TFS77)

2999 ccm 117 kW 4JJ1-TC 01.07 - 10.08 + AC; QTY: 2 AVX 13 x 1562  
ALT 13A 1030

### RODEO Pritsche/Fahrgestell (RA)

#### 2.4 i (TFR32)

2405 ccm 94 kW C 24 SE 08.03 - 07.08 + AC 13A 915  
+ PS 13A 965  
ALT 11A 1040

#### 3.5 i (TFR26)

3494 ccm 147 kW 6VE1 02.03 - 12.05 ALT 6 PK 2300

#### 3.5 i 4x4 (TFS26)

3494 ccm 147 kW 6VE1 02.03 - 12.05 ALT 6 PK 2300

#### 3.0 DiTD (TFR77)

2999 ccm 117 kW 4JJ1-TC 01.07 - 10.08 + AC; QTY: 2 AVX 13 x 1562  
ALT 13A 1030

## HYUNDAI

### GRACE Bus

#### 2.5 TD

2476 ccm 59 kW D4BF 06.98 - 10.01 BAL ZRK 1202  
CAM ZRK 1522  
BAL KT 1391

### H100 Bus (P)

#### 2.4

2351 ccm 84 kW G4CS 01.97 - 03.00 ALT AVX 10 x 960  
ALT FROM: 08.97 4 PK 980  
BAL ZRK 1388  
CAM ZRK 1285  
CAM KT 1276  
CAM KT 1321

#### 2.4

2351 ccm 90 kW G4CS 07.93 - 03.00 BAL ZRK 1388



## HYUNDAI

### H100 Bus (P)

#### 2.4

2351 ccm	90 kW	G4CS	07.93 - 03.00	CAM		ZRK 1285
				CAM		KT 1276
				CAM		KT 1321

#### 2.5 D

2477 ccm	55 kW	D4BA;D4BX	07.93 - 12.94	BAL	FROM: 03.94	ZRK 1153
				BAL	UNTIL: 02.94	ZRK 1277
				CAM		ZRK 1260
				CAM		KT 1143

#### 2.5 D

2477 ccm	57 kW	D4BA	12.94 - 03.00	AC-C	FROM: 05.99	AVX 13 x 1400
				ALT		17 x 1060
				BAL	FROM: 02.96	ZRK 1202
				BAL	UNTIL: 01.96	ZRK 1153
				CAM	FROM: 06.96	ZRK 1522
				CAM	UNTIL: 05.96	ZRK 1260
				BAL	FROM: 02.96	KT 1391
				CAM	FROM: 06.96	KT 1488
				CAM	UNTIL: 05.96	KT 1143

#### 2.5 TD

2477 ccm	59 kW	D4BF	07.93 - 03.00	AC-C	FROM: 05.99	AVX 13 x 1400
				BAL	FROM: 02.96	ZRK 1202
				BAL	UNTIL: 01.96	ZRK 1153
				CAM	FROM: 06.96	ZRK 1522
				CAM	UNTIL: 05.96	ZRK 1260
				BAL	FROM: 06.96	KT 1391
				CAM	FROM: 06.96	KT 1488
				CAM	UNTIL: 05.96	KT 1143

### H100 Kasten

#### 2.4

2351 ccm	82 kW	G4CS	10.97 - 12.04	BAL		ZRK 1388
				CAM		ZRK 1285
				CAM		KT 1276

#### 2.5 D

2477 ccm	55 kW	D4BA;D4BX	07.93 - 12.94	ALT		17 x 1060
				BAL	FROM: 03.94	ZRK 1153
				BAL	UNTIL: 02.94	ZRK 1277
				CAM		ZRK 1260
				CAM		KT 1143

#### 2.5 D

2477 ccm	57 kW	D4BA	12.94 - 03.00	AC-C	FROM: 05.99	AVX 13 x 1400
				ALT	FROM: 11.96; REQ: 2	AVX 10 x 1100
				ALT	REQ: 2; + ABS	AVX 10 x 1100
				ALT	UNTIL: 11.96	17 x 1060
				BAL	FROM: 02.96	ZRK 1202
				BAL	UNTIL: 01.96	ZRK 1153
				CAM	FROM: 06.96	ZRK 1522
				CAM	UNTIL: 05.96	ZRK 1260
				BAL	FROM: 06.96	KT 1391
				CAM	FROM: 06.96	KT 1488
				CAM	UNTIL: 05.96	KT 1143

### HIGHWAY VAN

#### 2.0 16V

1997 ccm	100 kW		03.00 -	ALT	OE-NO.: 25212-38001	4 PK 950
				PS	- AC	5 PK 1110
				PS	+ AC	5 PK 1390

#### 2.7 V6 24V

2656 ccm	125 kW	G6BA	03.00 -	ALT	- AC	6 PK 1700
				ALT	+ AC	6 PK 2000

### H-1 / STAREX

#### 2.4

2351 ccm	82 kW	G4CS	06.97 - 04.04	ALT	FROM: 10.97	4 PK 980
				BAL		ZRK 1388
				CAM		ZRK 1285
				CAM		KT 1276



## HYUNDAI

### H-1 / STAREX

<b>2.4</b>						
2351 ccm	82 kW	G4CS	06.97 - 04.04	CAM		KT 1321
<b>2.4 4WD</b>						
2351 ccm	82 kW	G4CS	02.98 - 04.04	ALT		4 PK 980
				BAL		ZRK 1388
				CAM		ZRK 1285
				CAM		KT 1276
				CAM		KT 1321
<b>2.4</b>						
2351 ccm	101 kW	G4JS	02.03 - 04.04	AC-C		4 PK 940
				ALT		4 PK 950
				PS	- AC	5 PK 1110
				PS	+ AC	5 PK 1390
<b>2.4</b>						
2351 ccm	107 kW	G4JS	11.01 - 04.04	AC-C	UNTIL: 08.07	4 PK 940
				ALT		4 PK 950
				PS	- AC	5 PK 1110
				PS	+ AC	5 PK 1390
<b>2.5 D</b>						
2476 ccm	57 kW	D4BF	10.97 - 04.04	PS	MTR-CODE: 4D56;D4BF	4 PK 1060
				PS	MTR-CODE: D4BF	4 PK 1060
				BAL		ZRK 1202
				CAM		ZRK 1522
<b>2.5 TD</b>						
2476 ccm	59 kW	D4BF	06.97 - 04.04	ALT		AVX 10 x 1100
				PS		4 PK 1060
				BAL		ZRK 1202
				CAM		ZRK 1522
				BAL		KT 1391
				CAM		KT 1488
<b>2.5 TD 4WD</b>						
2476 ccm	59 kW	D4BF	02.98 - 04.04	ALT		AVX 10 x 1100
				PS		4 PK 1060
				BAL		ZRK 1202
				CAM		ZRK 1522
				BAL		KT 1391
				CAM		KT 1488
<b>2.5 TCI</b>						
2476 ccm	73 kW	D4BH	10.97 - 12.07	PS		4 PK 1060
				BAL		ZRK 1202
				CAM		ZRK 1522
				BAL		KT 1391
				CAM		KT 1488
<b>2.5 TD 4WD</b>						
2476 ccm	73 kW	D4BH	03.01 - 04.04	PS	MTR-CODE: D4BH	4 PK 1060
				BAL		ZRK 1202
				CAM		ZRK 1522
				BAL		KT 1391
				CAM		KT 1488
<b>2.5 TCI</b>						
2476 ccm	74 kW	D4BH	05.04 - 12.07	PS		4 PK 1060
				BAL		ZRK 1202
				CAM		ZRK 1522
				BAL		KT 1391
<b>2.5 TD 4WD</b>						
2476 ccm	74 kW	D4BH	11.01 - 04.04	PS	MTR-CODE: D4BH	4 PK 1060
				BAL		ZRK 1202
				CAM		ZRK 1522
				BAL		KT 1391
				CAM		KT 1488
<b>2.5 CRDi</b>						
2497 ccm	81 kW		06.06 - 12.07	ALT	UNTIL: 09.07; MTR-CODE: D4CC; - AC	7 PK 1730
				ALT	UNTIL: 09.07; MTR-CODE: D4CC; + AC	7 PK 2283
<b>2.5 CRDi</b>						
2497 ccm	103 kW		12.02 - 04.04	ALT	- AC	7 PK 1730
				ALT	+ AC	7 PK 2283



## HYUNDAI

### H-1 / STAREX

#### 2.5 CRDi 4x4

2497 ccm	103 kW		12.02 - 04.04	ALT	- AC	7 PK 1730
				ALT	+ AC	7 PK 2283

### H-1 Kasten

#### 2.4

2351 ccm	82 kW	G4CS	03.00 - 04.04	ALT	MTR-CODE: G4CS	4 PK 980
				ALT	MTR-CODE: G4CS24L	4 PK 980
				BAL		ZRK 1388
				CAM		ZRK 1285
				CAM		KT 1276
				CAM		KT 1321

#### 2.4

2351 ccm	107 kW	G4JS	11.01 - 04.04	AC-C	UNTIL: 08.07	4 PK 940
				ALT		4 PK 950
				PS	- AC	5 PK 1110
				PS	+ AC	5 PK 1390

#### 2.5 TD

2476 ccm	59 kW	D4BF	03.00 - 09.00	PS		4 PK 1060
				BAL		ZRK 1202
				CAM		ZRK 1522
				BAL		KT 1391
				CAM		KT 1488

#### 2.5 TD

2476 ccm	73 kW	D4BH	03.00 - 04.04	PS		4 PK 1060
				BAL		ZRK 1202
				CAM		ZRK 1522
				BAL		KT 1391
				CAM		KT 1488

#### 2.5 TD

2476 ccm	74 kW	D4BH	10.01 - 04.04	AC-C		AVX 13 x 950
				ALT	REQ: 2	AVX 10 x 1090
				PS		4 PK 1060
				BAL		ZRK 1202
				CAM		ZRK 1522
				BAL		KT 1391
				CAM		KT 1488

#### 2.5 CRDi

2497 ccm	81 kW	D4CB	07.01 - 04.04	ALT	- AC	7 PK 1730
				ALT	+ AC	7 PK 2283

#### 2.5 CRDi

2497 ccm	103 kW	D4CB	08.03 - 04.04	ALT	- AC	7 PK 1730
				ALT	+ AC	7 PK 2283

### H-1 Pritsche/Fahrgestell

#### 2.5 D

2477 ccm	73 kW	D4BH	06.00 - 10.05	PS		4 PK 1060
				BAL		ZRK 1202
				CAM		ZRK 1522
				BAL		KT 1391

### H-1 Cargo

#### 2.5 CRDi

2497 ccm	81 kW	D4CB	02.08 -	ALT	- AC	7 PK 1730
				ALT	+ AC	7 PK 2283

#### 2.5 CRDi

2497 ccm	125 kW	D4CB	02.08 -	ALT	- AC	7 PK 1730
				ALT	+ AC	7 PK 2283

### H-1 Travel

#### 2.5 CRDi

2497 ccm	125 kW	D4CB	05.08 -	ALT	- AC	7 PK 1730
				ALT	+ AC	7 PK 2283
				ALT	OE-NO.: 25212-4A000	7 PK 2283
				ALT	OE-NO.: 25212-4A010	7 PK 1730
				ALT	UNTIL: 07.08; MTR-CODE: D4DF; + AC	7 PK 2271





## HYUNDAI

### PORTER Bus

<b>2.4</b>						
2351 ccm	82 kW	G4CS	03.96 - 04.04	ALT BAL CAM CAM	FROM: 07.97	4 PK 980 ZRK 1388 ZRK 1285 KT 1276
<b>2.5 TD</b>						
2477 ccm	73 kW	D4BH	07.94 - 04.04	PS	FROM: 03.96	4 PK 1060

### PORTER Kasten

<b>2.4</b>						
2351 ccm	82 kW	G4CS	03.96 - 04.04	ALT BAL CAM CAM	FROM: 07.97	4 PK 980 ZRK 1388 ZRK 1285 KT 1276
<b>2.5 TD</b>						
2477 ccm	73 kW	D4BH	07.94 - 04.04	PS BAL CAM BAL CAM	FROM: 03.96	4 PK 1060 ZRK 1202 ZRK 1522 KT 1391 KT 1488

### PORTER Pick-up

<b>2.4</b>						
2351 ccm	82 kW	G4CS	03.96 - 04.04	ALT BAL CAM CAM	FROM: 07.97	4 PK 980 ZRK 1388 ZRK 1285 KT 1276
<b>2.5 TD</b>						
2477 ccm	73 kW	D4BH	07.94 - 04.04	PS BAL CAM BAL CAM	FROM: 03.96	4 PK 1060 ZRK 1202 ZRK 1522 KT 1391 KT 1488

### PORTER Kasten

<b>2.5 TCi</b>						
2477 ccm	74 kW	D4BH	05.04 -	PS		4 PK 1060

## ISUZU

### MIDI Bus (94000, 98000)

<b>2.0 TD (98000)</b>						
1995 ccm	51 kW	4FC1T	01.89 -	PS		AVX 10 x 660
<b>2.2 D (98000)</b>						
2189 ccm	45 kW	4FD1	01.89 -	PS		AVX 10 x 660
<b>2.2 D 4WD (94000)</b>						
2189 ccm	45 kW	4FD1	01.89 -	PS		AVX 10 x 660
<b>2.4 D (98000)</b>						
2380 ccm	56 kW	4FG1T	01.94 -	PS		AVX 10 x 660

### MIDI Van (94000, 98000)

<b>2.0 TD (98000)</b>						
1995 ccm	51 kW	4FC1T	01.89 -	PS		AVX 10 x 660
<b>2.2 D (98000)</b>						
2189 ccm	45 kW	4FD1	01.89 -	PS		AVX 10 x 660
<b>2.2 D 4WD (94000)</b>						
2189 ccm	45 kW	4FD1	01.89 -	PS		AVX 10 x 660
<b>2.4 TD (98000)</b>						
2380 ccm	56 kW	4FG1T	01.94 -	PS		AVX 10 x 660

### MIDI Kasten (98000N)

<b>2.0 4WD</b>						
1995 ccm	61 kW	4ZC1	09.88 -	AIR-P		AVX 10 x 763
<b>2.2 D</b>						
2189 ccm	45 kW	4FD1	01.89 -	PS		AVX 10 x 660
<b>2.2 D 4WD</b>						
2189 ccm	45 kW	4FD1	09.88 -	PS		AVX 10 x 660



## ISUZU

### MIDI Kasten (98000N)

<b>2.4 TD</b>	2380 ccm	56 kW	4FG1T	02.94 -	PS		AVX 10 x 660
---------------	----------	-------	-------	---------	----	--	--------------

## IVECO

### DAILY I Kasten/Kombi

#### 30-8 (10014131, 10014132, 10014137, 10014231, 10014232...)

2445 ccm	53 kW	8140.61.200	01.78 - 12.89	ALT CAM CAM			AVX 10 x 950 ZRK 1100 KT 1091
----------	-------	-------------	---------------	-------------------	--	--	-------------------------------------

#### 35-8 (10034131, 10034132, 10034137, 10034224, 10034231...)

2445 ccm	53 kW	8140.61.200	01.78 - 12.89	ALT ALT CAM CAM			AVX 10 x 925 AVX 10 x 950 ZRK 1100 KT 1091
----------	-------	-------------	---------------	--------------------------	--	--	---

#### 35-10 (10314204, 10314211, 10314212, 10314217, 10314411...)

2445 ccm	68 kW	8140.21.200	01.85 - 12.89	ALT CAM CAM			AVX 10 x 925 ZRK 1102 KT 1098
----------	-------	-------------	---------------	-------------------	--	--	-------------------------------------

#### 40-8 V

2445 ccm	53 kW	8140.61.200	01.83 - 06.89	CAM			KT 1091
----------	-------	-------------	---------------	-----	--	--	---------

#### 40-10 V

2445 ccm	68 kW	8140.27 S	01.85 - 12.89	AC-C ALT ALT CAM CAM	UNTIL MTR-NO: 1927815  + AC UNTIL MTR-NO: 1307400		AVX 10 x 850 AVX 10 x 925 AVX 10 x 1075 TM ZRK 1102 KT 1098
----------	-------	-----------	---------------	----------------------------------	--	--	---

#### 45-10 V (10334204, 10334211, 10334212, 10334217, 10334404)

2445 ccm	68 kW	8140.21.200	01.85 - 12.89	AC-C ALT ALT CAM CAM	UNTIL MTR-NO: 1927815  + AC UNTIL MTR-NO: 1307400		AVX 10 x 850 AVX 10 x 925 AVX 10 x 1075 TM ZRK 1102 KT 1098
----------	-------	-------------	---------------	----------------------------------	--	--	---

#### 49-10 V (10354204, 10354211, 10354212, 10354217...)

2445 ccm	68 kW	8140.21.200	01.85 - 12.89	AC-C ALT ALT CAM CAM	UNTIL MTR-NO: 1927815  + AC UNTIL MTR-NO: 1307400		AVX 10 x 850 AVX 10 x 925 AVX 10 x 1075 TM ZRK 1102 KT 1098
----------	-------	-------------	---------------	----------------------------------	--	--	---

### DAILY I Pritsche/Fahrgestell

#### 30-8 (10011131, 10011132, 10011231, 10011232, 10011237...)

2445 ccm	53 kW	8140.61.200	01.78 - 12.89	ALT CAM CAM			AVX 10 x 925 ZRK 1100 KT 1091
----------	-------	-------------	---------------	-------------------	--	--	-------------------------------------

#### 35-8 (10031131, 10031132, 10031137, 10031224, 10031231...)

2445 ccm	53 kW	8140.61.200	01.78 - 12.89	ALT CAM CAM			AVX 10 x 925 ZRK 1100 KT 1091
----------	-------	-------------	---------------	-------------------	--	--	-------------------------------------

#### 35-10 (10310311, 10311111, 10311112, 10311117, 10311211...)

2445 ccm	68 kW	8140.21.200	01.85 - 12.89	ALT ALT CAM CAM	AMP: 85 UNTIL MTR-NO: 1307400		AVX 10 x 925 AVX 10 x 913 ZRK 1102 KT 1098
----------	-------	-------------	---------------	--------------------------	----------------------------------	--	---

#### 40-8

2445 ccm	53 kW	8140.61.200	01.83 - 06.89	CAM			KT 1091
----------	-------	-------------	---------------	-----	--	--	---------

#### 40-10

2445 ccm	68 kW	8140.27 S	01.85 - 12.89	AC-C AC-C ALT ALT CAM CAM	FROM MTR-NO: 1927816 UNTIL MTR-NO: 1927815  + AC UNTIL MTR-NO: 1307400		AVX 10 x 875 AVX 10 x 850 AVX 10 x 925 AVX 10 x 1075 TM ZRK 1102 KT 1098
----------	-------	-----------	---------------	--	--	--	---

#### 45-10 (10331211, 10331212, 10331217, 10331304, 10331311...)

2445 ccm	68 kW	8140.21.200	01.85 - 12.89	ALT CAM CAM	UNTIL MTR-NO: 1307400		AVX 10 x 925 ZRK 1102 KT 1098
----------	-------	-------------	---------------	-------------------	-----------------------	--	-------------------------------------



## IVECO

### DAILY I Pritsche/Fahrgestell

#### 49-10 (10350211, 10350304, 10350311, 10350404, 10350411...)

2445 ccm	68 kW	8140.21.200	01.85 - 12.89	AC-C	UNTIL MTR-NO: 1927815	AVX 10 x 850
				ALT		AVX 10 x 925
				ALT	+ AC	AVX 10 x 1075 TM
				CAM	UNTIL MTR-NO: 1307400	ZRK 1102
				CAM		KT 1098

### DAILY II Bus

#### A 40-10 (94139111, 94139131, 94139311, 94139315...)

2499 ccm	76 kW	8140.27.2720	01.91 - 12.96	AC-C	UNTIL MTR-NO: 1927815	AVX 10 x 850
				ALT		AVX 10 x 925
				ALT	+ AC	AVX 10 x 1075 TM
				CAM	UNTIL MTR-NO: 1307400	ZRK 1102
				CAM	FROM MTR-NO: 1307401	KT 1217
				CAM	UNTIL MTR-NO: 1307400	KT 1098

#### A 40-10 (95719111, 95719131, 95719311, 95719315...)

2798 ccm	76 kW	8140.23.	09.96 - 05.99	AC-C		AVX 13 x 890
				ALT		AVX 10 x 925
				ALT	+ AC	AVX 10 x 1050
				W-P		AVX 13 x 800 TM
				W-P	OPT	AVX 13 x 800
				CAM	MTR-CODE: 8140.23.3720	KT 1340

#### A 40-12 (95819311, 95819315, 95819317, 95819331)

2798 ccm	90 kW	8140.43.	05.96 - 05.99	ALT		AVX 10 x 925
				CAM	MTR-CODE: 8140.43.3711	KT 1340

#### A 45-10 (94159111, 94159131, 94159211, 94159311...)

2499 ccm	76 kW	8140.27.2720	01.91 - 04.96	AC-C	UNTIL MTR-NO: 1927815	AVX 10 x 850
				ALT		AVX 10 x 925
				ALT	+ AC	AVX 10 x 1075 TM
				CAM	UNTIL MTR-NO: 1307400	ZRK 1102
				CAM	FROM MTR-NO: 1307401	KT 1217
				CAM	UNTIL MTR-NO: 1307400	KT 1098

#### A 45-10 (95739111, 95739131, 95739311, 95739317, 95739331)

2798 ccm	76 kW	8140.23.	05.96 - 05.99	AC-C		AVX 13 x 890
				ALT		AVX 10 x 925
				ALT	+ AC	AVX 10 x 1050
				W-P		AVX 13 x 800 TM
				W-P	OPT	AVX 13 x 800
				CAM	MTR-CODE: 8140.23.3720	KT 1340

#### A 45-12 (94179211, 94179231, 94179311, 94179317...)

2499 ccm	85 kW	8140.47.2711;8140.47.2721	06.90 - 04.96	AC-C	UNTIL MTR-NO: 1927815	AVX 10 x 850
				ALT		AVX 10 x 925
				ALT	+ AC	AVX 10 x 1075 TM
				CAM	FROM MTR-NO: 1307401	KT 1217
				CAM	UNTIL MTR-NO: 1307400	KT 1098

#### A 45-12 (95839211, 95839231, 95839311, 95839317...)

2798 ccm	90 kW	8140.43.	05.96 - 05.99	ALT		AVX 10 x 925
				CAM		KT 1340

### DAILY II Kasten/Kombi

#### 30-8 (12914111, 12914112, 12914117, 12914131, 12914137...)

2499 ccm	55 kW	8140.07.2700;8140.07.2712	01.89 - 08.98	ALT		AVX 10 x 925
				CAM		ZRK 1312
				CAM	UNTIL MTR-NO: 1307400; MTR-CODE: 814007	ZRK 1102
				CAM	FROM MTR-NO: 1307401; MTR-CODE: 8140.07.2700;2712	KT 1217
				CAM	FROM MTR-NO: 1307401; MTR-CODE: 8140.67F	KT 1229
				CAM	UNTIL MTR-NO: 1307400; MTR-CODE: 8140.07.2700;2712	KT 1098
				CAM	UNTIL MTR-NO: 1307400; MTR-CODE: 8140.67F	KT 1091

#### 30-8 (12914111, 12914112, 12914117, 12914131, 12914137...)

2499 ccm	55 kW	8140.07.2700;8140.07.2712	01.89 - 08.98	ALT		AVX 10 x 925
				CAM		ZRK 1312
				CAM	UNTIL MTR-NO: 1307400; MTR-CODE: 814007	ZRK 1102
				CAM	FROM MTR-NO: 1307401; MTR-CODE: 8140.07.2700;2712	KT 1217



## IVECO

### DAILY II Kasten/Kombi

#### 30-8 (12914111, 12914112, 12914117, 12914131, 12914137...)

2499 ccm	55 kW	8140.07.2700;8140.07.2712	01.89 - 08.98	CAM	FROM MTR-NO: 1307401; MTR-CODE: 8140.67F	KT 1229
				CAM	UNTIL MTR-NO: 1307400; MTR-CODE: 8140.07.2700;2712	KT 1098
				CAM	UNTIL MTR-NO: 1307400; MTR-CODE: 8140.67F	KT 1091

#### 30-8 (12914111, 12914112, 12914117, 12914131, 12914137...)

2499 ccm	60 kW	8140.67F.	01.89 - 08.98	ALT		AVX 10 x 925
				CAM		ZRK 1312
				CAM	UNTIL MTR-NO: 1307400; MTR-CODE: 814007	ZRK 1102
				CAM	FROM MTR-NO: 1307401; MTR-CODE: 8140.07.2700;2712	KT 1217
				CAM	FROM MTR-NO: 1307401; MTR-CODE: 8140.67F	KT 1229
				CAM	UNTIL MTR-NO: 1307400; MTR-CODE: 8140.07.2700;2712	KT 1098
				CAM	UNTIL MTR-NO: 1307400; MTR-CODE: 8140.67F	KT 1091

#### 30-8 (12914111, 12914112, 12914117, 12914131, 12914137...)

2499 ccm	60 kW	8140.67F.;8140.67F.3710;8140.67F.3711;8140.67F.3713;8140.67F.3721	01.89 - 08.98	ALT		AVX 10 x 925
				CAM		ZRK 1312
				CAM	UNTIL MTR-NO: 1307400; MTR-CODE: 814007	ZRK 1102
				CAM	FROM MTR-NO: 1307401; MTR-CODE: 8140.07.2700;2712	KT 1217
				CAM	FROM MTR-NO: 1307401; MTR-CODE: 8140.67F	KT 1229
				CAM	UNTIL MTR-NO: 1307400; MTR-CODE: 8140.07.2700;2712	KT 1098
				CAM	UNTIL MTR-NO: 1307400; MTR-CODE: 8140.67F	KT 1091

#### 30-8 (14914111, 14914117, 14914211, 14914217, 14915111...)

2499 ccm	60 kW	8140.67F.;8140.67F.3710;8140.67F.3711;8140.67F.3713;8140.67F.3721	01.89 - 08.98	ALT		AVX 10 x 925
				CAM	UNTIL MTR-NO: 1307400; MTR-CODE: 814007	ZRK 1102
				CAM		KT 1229

#### 30-8 (14914111, 14914117, 14914211, 14914217, 14915111...)

2798 ccm	62 kW	8140.63.	09.98 - 05.99	ALT		AVX 10 x 925
				CAM		KT 1217

#### 30-8 V (14914111, 14914117, 14914211, 14914217...)

2798 ccm	62 kW	8140.63.	09.98 - 05.99	CAM		KT 1217
----------	-------	----------	---------------	-----	--	---------

#### 30-10

2798 ccm	76 kW	8140.23.	01.97 - 05.99	CAM		ZRK 1332
				CAM	MTR-CODE: 8140.23.3720	KT 1340

#### 30-10 C

2798 ccm	76 kW	8140.23.	01.97 - 05.99	CAM		ZRK 1332
				CAM	MTR-CODE: 8140.23.3720	KT 1340

#### 30-10 C

2798 ccm	76 kW	8140.23.	01.97 - 05.99	CAM		ZRK 1332
				CAM	MTR-CODE: 8140.23.3720	KT 1340

#### 35-8 (12934104, 12934111, 12934112, 12934117, 12934124...)

2499 ccm	55 kW	8140.07.2700;8140.07.2712	01.91 - 08.98	ALT		AVX 10 x 925
				CAM	UNTIL MTR-NO: 1307400; MTR-CODE: 814007	ZRK 1102
				CAM	FROM MTR-NO: 1307401; MTR-CODE: 8140.07.2700;2712	KT 1217
				CAM	FROM MTR-NO: 1307401; MTR-CODE: 8140.67F	KT 1229
				CAM	UNTIL MTR-NO: 1307400; MTR-CODE: 8140.07.2700;2712	KT 1098
				CAM	UNTIL MTR-NO: 1307400; MTR-CODE: 8140.67F	KT 1091

#### 35-8 (12934104, 12934111, 12934112, 12934117, 12934124...)

2499 ccm	55 kW	8140.07.2700;8140.07.2712	01.91 - 08.98	ALT		AVX 10 x 925
				CAM	UNTIL MTR-NO: 1307400; MTR-CODE: 814007	ZRK 1102
				CAM	FROM MTR-NO: 1307401; MTR-CODE: 8140.07.2700;2712	KT 1217
				CAM	FROM MTR-NO: 1307401; MTR-CODE: 8140.67F	KT 1229



## IVECO

### DAILY II Kasten/Kombi

#### 35-8 (12934104, 12934111, 12934112, 12934117, 12934124...)

2499 ccm	55 kW	8140.07.2700;8140.07.2712	01.91 - 08.98	CAM	UNTIL MTR-NO: 1307400; MTR-CODE: 8140.07.2700;2712	KT 1098
				CAM	UNTIL MTR-NO: 1307400; MTR-CODE: 8140.67F	KT 1091

#### 35-8 (12934104, 12934111, 12934112, 12934117, 12934124...)

2499 ccm	60 kW	8140.67F.;8140.67F.3701;8140.67F.3710;8140.67F.3711;8140.67F.3713;8140.67F.3721	01.91 - 08.98	ALT		AVX 10 x 925
				CAM	UNTIL MTR-NO: 1307400; MTR-CODE: 814007	ZRK 1102
				CAM	FROM MTR-NO: 1307401; MTR-CODE: 8140.07.2700;2712	KT 1217
				CAM	FROM MTR-NO: 1307401; MTR-CODE: 8140.67F	KT 1229
				CAM	UNTIL MTR-NO: 1307400; MTR-CODE: 8140.07.2700;2712	KT 1098
				CAM	UNTIL MTR-NO: 1307400; MTR-CODE: 8140.67F	KT 1091

#### 35-8 (12934104, 12934111, 12934112, 12934117, 12934124...)

2499 ccm	60 kW	8140.67F.;8140.67F.3701;8140.67F.3710;8140.67F.3711;8140.67F.3713;8140.67F.3721	01.91 - 08.98	ALT		AVX 10 x 925
				CAM	UNTIL MTR-NO: 1307400; MTR-CODE: 814007	ZRK 1102
				CAM	FROM MTR-NO: 1307401; MTR-CODE: 8140.07.2700;2712	KT 1217
				CAM	FROM MTR-NO: 1307401; MTR-CODE: 8140.67F	KT 1229
				CAM	UNTIL MTR-NO: 1307400; MTR-CODE: 8140.07.2700;2712	KT 1098
				CAM	UNTIL MTR-NO: 1307400; MTR-CODE: 8140.67F	KT 1091

#### 35-8 (14934104, 14934111, 14934204, 14934205, 14934211...)

2798 ccm	62 kW	8140.63.	09.98 - 05.99	CAM		KT 1217
----------	-------	----------	---------------	-----	--	---------

#### 35-10 (12974212, 12974217, 13014111, 13014131, 13014204...)

2499 ccm	76 kW	8140.47R.2790	01.89 - 08.98	AC-C	UNTIL MTR-NO: 1927815	AVX 10 x 850
				ALT		AVX 10 x 925
				ALT	+ AC	AVX 10 x 1075 TM
				CAM	FROM MTR-NO: 1307401	KT 1217
				CAM	UNTIL MTR-NO: 1307400	KT 1098

#### 35-10 (12974212, 12974217, 13014111, 13014131, 13014204...)

2499 ccm	80 kW	8140.47R	01.89 - 08.98	AC-C	UNTIL MTR-NO: 1927815	AVX 10 x 850
				ALT		AVX 10 x 925
				ALT	+ AC	AVX 10 x 1075 TM
				CAM	FROM MTR-NO: 1307401	KT 1217
				CAM	UNTIL MTR-NO: 1307400	KT 1098

#### 35-10 (15034111, 15034204, 15034211, 15034215, 15034217...)

2798 ccm	76 kW	8140.23.	01.96 - 05.99	AC-C		AVX 13 x 890
				ALT		AVX 10 x 940
				ALT	+ AC	AVX 10 x 1050
				ALT	AMP: 85	AVX 10 x 925
				CAM	MTR-CODE: 8140.23.3720	KT 1340

#### 35-12 (13114131, 13114204, 13114211, 13114212, 13114217...)

2499 ccm	85 kW	8140.47.2700	01.90 - 04.96	AC-C	UNTIL MTR-NO: 1927815	AVX 10 x 850
				ALT		AVX 10 x 925
				ALT	+ AC	AVX 10 x 1075 TM
				CAM	FROM MTR-NO: 1307401	KT 1217
				CAM	UNTIL MTR-NO: 1307400	KT 1098

#### 40-10 V

2499 ccm	76 kW	8140.27.2720	01.90 - 04.96	AC-C	UNTIL MTR-NO: 1927815	AVX 10 x 850
				ALT		AVX 10 x 925
				ALT	+ AC	AVX 10 x 1075 TM
				CAM	UNTIL MTR-NO: 1307400	ZRK 1102
				CAM	FROM MTR-NO: 1307401	KT 1217
				CAM	UNTIL MTR-NO: 1307400	KT 1098

#### 40-10 4x4 (15214104, 15214111, 15214117, 15215111)

2798 ccm	76 kW	8140.23.	01.97 - 05.99	ALT		AVX 10 x 940
				ALT	AMP: 85	AVX 10 x 925
				CAM	MTR-CODE: 8140.23.3720	KT 1340



## IVECO

### DAILY II Kasten/Kombi

<b>40-12 V</b>						
2499 ccm	85 kW	8140.47.2700	10.90 - 04.96	CAM	FROM MTR-NO: 1307401	KT 1217
				CAM	UNTIL MTR-NO: 1307400	KT 1098
<b>45-10 V (13034204, 13034211, 13034212, 13034224...)</b>						
2499 ccm	76 kW	8140.27.2720	01.89 - 04.96	AC-C	UNTIL MTR-NO: 1927815	AVX 10 x 850
				ALT		AVX 10 x 925
				ALT	+ AC	AVX 10 x 1075 TM
				CAM	UNTIL MTR-NO: 1307400	ZRK 1102
				CAM	FROM MTR-NO: 1307401	KT 1217
				CAM	UNTIL MTR-NO: 1307400	KT 1098
<b>49-10 V (13054204, 13054211, 13054212, 13054215...)</b>						
2499 ccm	76 kW	8140.27.2700;8140.47R.2790	01.89 - 04.96	AC-C	UNTIL MTR-NO: 1927815	AVX 10 x 850
				ALT		AVX 10 x 925
				ALT	+ AC	AVX 10 x 1075 TM
				CAM	UNTIL MTR-NO: 1307400	ZRK 1102
				CAM	FROM MTR-NO: 1307401	KT 1217
				CAM	UNTIL MTR-NO: 1307400	KT 1098
<b>49-12 V (13134124, 13134204, 13134211, 13134212...)</b>						
2499 ccm	85 kW	8140.47.2711;8140.47.2721	06.90 - 04.96	AC-C	UNTIL MTR-NO: 1927815	AVX 10 x 850
				ALT		AVX 10 x 925
				ALT	+ AC	AVX 10 x 1075 TM
				CAM	FROM MTR-NO: 1307401	KT 1217
				CAM	UNTIL MTR-NO: 1307400	KT 1098
<b>49-12 V (15154204, 15154211, 15154215, 15154217...)</b>						
2798 ccm	90 kW	8140.43.	05.96 - 05.99	AC-C		AVX 13 x 890
				ALT		AVX 10 x 940
				ALT	+ AC	AVX 10 x 1050
				ALT	AMP: 85	AVX 10 x 925
				W-P		AVX 13 x 800 TM
				W-P	OPT	AVX 13 x 800
				CAM	MTR-CODE: 8140.43.3711	KT 1340
<b>59-12 V (13154404, 13154411, 13154412, 13154417...)</b>						
2499 ccm	85 kW	8140.47.2700;8140.47.2711	05.91 - 04.96	AC-C	UNTIL MTR-NO: 1927815	AVX 10 x 850
				ALT		AVX 10 x 925
				ALT	+ AC	AVX 10 x 1075 TM
				CAM	FROM MTR-NO: 1307401	ZRK 1316
				CAM	UNTIL MTR-NO: 1307400	ZRK 1102
				CAM	FROM MTR-NO: 1307401	KT 1217
				CAM	UNTIL MTR-NO: 1307400	KT 1098
<b>59-12 V (15174404, 15174411, 15174415, 15174417)</b>						
2798 ccm	90 kW	8140.43.	05.96 - 05.99	AC-C		AVX 13 x 890
				ALT		AVX 10 x 940
				ALT	+ AC	AVX 10 x 1050
				ALT	AMP: 85	AVX 10 x 925
				W-P		AVX 13 x 800 TM
				W-P	OPT	AVX 13 x 800
				CAM	MTR-CODE: 8140.43.3711	KT 1340

### DAILY II Kipper

<b>35-8 K (14930304, 14931104, 14931111, 14931115...)</b>						
2798 ccm	62 kW	8140.63.	09.98 - 05.99	CAM		KT 1217
<b>35-10 K (15030111, 15030211, 15030311, 15031111...)</b>						
2798 ccm	76 kW	8140.23.	01.97 - 05.99	AC-C		AVX 13 x 890
				ALT		AVX 10 x 940
				ALT	+ AC	AVX 10 x 1050
				ALT	AMP: 85	AVX 10 x 925
				W-P		AVX 13 x 800 TM
				W-P	OPT	AVX 13 x 800
				CAM	MTR-CODE: 8140.23.3720	KT 1340
<b>35-12 K (15130311, 15130411, 15131111, 15131204...)</b>						
2798 ccm	90 kW	8140.43.	09.96 - 08.98	AC-C		AVX 13 x 890
				ALT		AVX 10 x 940
				ALT	+ AC	AVX 10 x 1050
				ALT	AMP: 85	AVX 10 x 925
				W-P		AVX 13 x 800 TM
				W-P	OPT	AVX 13 x 800
				CAM	MTR-CODE: 8140.43.3711	KT 1340



## IVECO

### DAILY II Kipper

#### 45-10 (13031204, 13031211, 13031212, 13031224, 13031231...)

2499 ccm	76 kW	8140.27.2720	01.92 - 04.96	AC-C	UNTIL MTR-NO: 1927815	AVX 10 x 850
				ALT		AVX 10 x 925
				ALT	+ AC	AVX 10 x 1075 TM
				CAM	UNTIL MTR-NO: 1307400	ZRK 1102
				CAM		KT 1217

#### 49-10 K (13056212, 13056224, 13056231, 13056237...)

2499 ccm	76 kW	8140.27.2700;8140.47R.2790	01.89 - 04.96	AC-C	UNTIL MTR-NO: 1927815	AVX 10 x 850
				ALT		AVX 10 x 925
				ALT	+ AC	AVX 10 x 1075 TM
				CAM	UNTIL MTR-NO: 1307400; MTR-CODE: 814027	ZRK 1102
				CAM	FROM MTR-NO: 1307401	KT 1217
				CAM	UNTIL MTR-NO: 1307400	KT 1098

#### 49-10 K (15056204, 15056211, 15056304, 15056311)

2798 ccm	76 kW	8140.23.	05.96 - 05.99	AC-C		AVX 13 x 890
				ALT		AVX 10 x 940
				ALT	+ AC	AVX 10 x 1050
				ALT	AMP: 85	AVX 10 x 925
				W-P		AVX 13 x 800 TM
				W-P	OPT	AVX 13 x 800
				CAM	MTR-CODE: 8140.23.3720	KT 1340

#### 49-12 K (13136204, 13136211, 13136212, 13136224...)

2499 ccm	85 kW	8140.47.2711;8140.47.2721	06.90 - 04.96	AC-C	UNTIL MTR-NO: 1927815	AVX 10 x 850
				ALT		AVX 10 x 925
				ALT	+ AC	AVX 10 x 1075 TM
				CAM	FROM MTR-NO: 1307401	KT 1217
				CAM	UNTIL MTR-NO: 1307400	KT 1098

#### 49-12 K

2798 ccm	90 kW	8140.43.	05.96 - 05.99	CAM	MTR-CODE: 8140.43.3711	KT 1340
----------	-------	----------	---------------	-----	------------------------	---------

#### 59-12 K (13156211, 13156212, 13156231, 13156311...)

2499 ccm	85 kW	8140.47.2700;8140.47.2711	05.91 - 04.96	AC-C	UNTIL MTR-NO: 1927815	AVX 10 x 850
				ALT		AVX 10 x 925
				ALT	+ AC	AVX 10 x 1075 TM
				CAM	FROM MTR-NO: 1307401	KT 1217
				CAM	UNTIL MTR-NO: 1307400	KT 1098

#### 59-12 K (15176211, 15176304, 15176311, 15176315...)

2798 ccm	90 kW	8140.43.	05.96 - 05.99	AC-C		AVX 13 x 890
				ALT		AVX 10 x 940
				ALT	+ AC	AVX 10 x 1050
				ALT	AMP: 85	AVX 10 x 925
				W-P		AVX 13 x 800 TM
				W-P	OPT	AVX 13 x 800
				CAM	MTR-CODE: 8140.43.3711	KT 1340

### DAILY II Pritsche/Fahrgestell

#### 30-8 (12910211, 12911111, 12911112, 12911117, 12911131...)

2499 ccm	55 kW	8140.07.2700	01.92 - 08.98	ALT		AVX 10 x 925
				CAM	UNTIL MTR-NO: 1307400; MTR-CODE: 814007	ZRK 1102
				CAM	FROM MTR-NO: 1307401; MTR-CODE: 8140.67F	KT 1229
				CAM	MTR-CODE: 8140.07.2700	KT 1217
				CAM	UNTIL MTR-NO: 1307400; MTR-CODE: 8140.67F	KT 1091

#### 30-8 (12910211, 12911111, 12911112, 12911117, 12911131...)

2499 ccm	55 kW	8140.07.2700	01.92 - 08.98	ALT		AVX 10 x 925
				CAM	UNTIL MTR-NO: 1307400; MTR-CODE: 814007	ZRK 1102
				CAM	FROM MTR-NO: 1307401; MTR-CODE: 8140.67F	KT 1229
				CAM	MTR-CODE: 8140.07.2700	KT 1217
				CAM	UNTIL MTR-NO: 1307400; MTR-CODE: 8140.67F	KT 1091

#### 30-8 (10011131, 10011132, 10011231, 10011232, 10011237...)

2499 ccm	60 kW	8140.67F.;8140.67F.3710;8140.67F.3711;8140.67F.3713;8140.67F.3721	01.92 - 08.98	ALT		AVX 10 x 925
				CAM		KT 1229

#### 30-8 (12910211, 12911111, 12911112, 12911117, 12911131...)

2499 ccm	60 kW	8140.67F.	01.92 - 08.98	ALT		AVX 10 x 925
----------	-------	-----------	---------------	-----	--	--------------



## IVECO

### DAILY II Pritsche/Fahrgestell

#### 30-8 (12910211, 12911111, 12911112, 12911117, 12911131...)

2499 ccm	60 kW	8140.67F.	01.92 - 08.98	CAM	UNTIL MTR-NO: 1307400; MTR-CODE: 814007	<b>ZRK 1102</b>
				CAM	FROM MTR-NO: 1307401; MTR-CODE: 8140.67F	<b>KT 1229</b>
				CAM	MTR-CODE: 8140.07.2700	<b>KT 1217</b>
				CAM	UNTIL MTR-NO: 1307400; MTR-CODE: 8140.67F	<b>KT 1091</b>

#### 30-8 (12910211, 12911111, 12911112, 12911117, 12911131...)

2499 ccm	60 kW	8140.67F.	01.92 - 08.98	ALT		<b>AVX 10 x 925</b>
				CAM	UNTIL MTR-NO: 1307400; MTR-CODE: 814007	<b>ZRK 1102</b>
				CAM	FROM MTR-NO: 1307401; MTR-CODE: 8140.67F	<b>KT 1229</b>
				CAM	MTR-CODE: 8140.07.2700	<b>KT 1217</b>
				CAM	UNTIL MTR-NO: 1307400; MTR-CODE: 8140.67F	<b>KT 1091</b>

#### 30-8 (10011131, 10011132, 10011231, 10011232, 10011237...)

2798 ccm	62 kW	8140.63.	09.98 - 05.99	CAM		<b>KT 1217</b>
----------	-------	----------	---------------	-----	--	----------------

#### 30-8 (14911111, 14911117, 14911211, 14911215, 14911217...)

2798 ccm	62 kW	8140.63.	09.98 - 05.99	ALT		<b>AVX 10 x 925</b>
				CAM		<b>KT 1217</b>

#### 30-10

2798 ccm	76 kW	8140.23.	01.98 - 05.99	CAM		<b>ZRK 1332</b>
				CAM	MTR-CODE: 8140.23.3720	<b>KT 1340</b>

#### 35-8 (12931102, 12931104, 12931111, 12931112, 12931117...)

2499 ccm	55 kW	8140.07.2700;8140.07.2712	01.89 - 08.98	ALT		<b>AVX 10 x 925</b>
				CAM	UNTIL MTR-NO: 1307400; MTR-CODE: 814007	<b>ZRK 1102</b>
				CAM	FROM MTR-NO: 1307401; MTR-CODE: 8140.07.2700;2712	<b>KT 1217</b>
				CAM	FROM MTR-NO: 1307401; MTR-CODE: 8140.67F	<b>KT 1229</b>
				CAM	UNTIL MTR-NO: 1307400; MTR-CODE: 8140.07.2700;2712	<b>KT 1098</b>
				CAM	UNTIL MTR-NO: 1307400; MTR-CODE: 8140.67F	<b>KT 1091</b>

#### 35-8 (12931102, 12931104, 12931111, 12931112, 12931117...)

2499 ccm	55 kW	8140.07.2700;8140.07.2712	01.89 - 08.98	ALT		<b>AVX 10 x 925</b>
				CAM	UNTIL MTR-NO: 1307400; MTR-CODE: 814007	<b>ZRK 1102</b>
				CAM	FROM MTR-NO: 1307401; MTR-CODE: 8140.07.2700;2712	<b>KT 1217</b>
				CAM	FROM MTR-NO: 1307401; MTR-CODE: 8140.67F	<b>KT 1229</b>
				CAM	UNTIL MTR-NO: 1307400; MTR-CODE: 8140.07.2700;2712	<b>KT 1098</b>
				CAM	UNTIL MTR-NO: 1307400; MTR-CODE: 8140.67F	<b>KT 1091</b>

#### 35-8 (12931102, 12931104, 12931111, 12931112, 12931117...)

2499 ccm	60 kW	8140.67F.	01.89 - 08.98	ALT		<b>AVX 10 x 925</b>
				CAM	UNTIL MTR-NO: 1307400; MTR-CODE: 814007	<b>ZRK 1102</b>
				CAM	FROM MTR-NO: 1307401; MTR-CODE: 8140.07.2700;2712	<b>KT 1217</b>
				CAM	FROM MTR-NO: 1307401; MTR-CODE: 8140.67F	<b>KT 1229</b>
				CAM	UNTIL MTR-NO: 1307400; MTR-CODE: 8140.07.2700;2712	<b>KT 1098</b>
				CAM	UNTIL MTR-NO: 1307400; MTR-CODE: 8140.67F	<b>KT 1091</b>

#### 35-8 (12931102, 12931104, 12931111, 12931112, 12931117...)

2499 ccm	60 kW	8140.67F.	01.89 - 08.98	ALT		<b>AVX 10 x 925</b>
				CAM	UNTIL MTR-NO: 1307400; MTR-CODE: 814007	<b>ZRK 1102</b>
				CAM	FROM MTR-NO: 1307401; MTR-CODE: 8140.07.2700;2712	<b>KT 1217</b>
				CAM	FROM MTR-NO: 1307401; MTR-CODE: 8140.67F	<b>KT 1229</b>
				CAM	UNTIL MTR-NO: 1307400; MTR-CODE: 8140.07.2700;2712	<b>KT 1098</b>
				CAM	UNTIL MTR-NO: 1307400; MTR-CODE: 8140.67F	<b>KT 1091</b>

#### 35-8 (14930304, 14931104, 14931111, 14931115, 14931204...)

2798 ccm	62 kW	8140.63.	09.98 - 05.99	CAM		<b>KT 1217</b>
----------	-------	----------	---------------	-----	--	----------------





## IVECO

### DAILY II Pritsche/Fahrgestell

#### 35-10 (12971112, 12971212, 12971312, 12971317, 12976112...)

2499 ccm	68 kW	8140.97.2781	01.89 - 12.96	AC-C	FROM MTR-NO: 1927816	AVX 10 x 875
				AC-C	UNTIL MTR-NO: 1927815	AVX 10 x 850
				ALT		AVX 10 x 925
				ALT	+ AC	AVX 10 x 1075 TM
				CAM	FROM MTR-NO: 1307401	KT 1217
				CAM	UNTIL MTR-NO: 1307400	KT 1098

#### 35-10 (12971112, 12971212, 12971312, 12971317, 12976112...)

2499 ccm	76 kW	8140.47R.2790	01.89 - 12.96	AC-C	FROM MTR-NO: 1927816	AVX 10 x 875
				AC-C	UNTIL MTR-NO: 1927815	AVX 10 x 850
				ALT		AVX 10 x 925
				ALT	+ AC	AVX 10 x 1075 TM
				CAM	FROM MTR-NO: 1307401	KT 1217
				CAM	UNTIL MTR-NO: 1307400	KT 1098

#### 35-10 (15030111, 15030211, 15030311, 15031111, 15031117...)

2798 ccm	76 kW	8140.23.	01.96 - 05.99	AC-C		AVX 13 x 890
				ALT		AVX 10 x 940
				ALT	+ AC	AVX 10 x 1050
				ALT	AMP: 85	AVX 10 x 925
				W-P		AVX 13 x 800 TM
				W-P	OPT	AVX 13 x 800
				CAM		ZRK 1332
				CAM	MTR-CODE: 8140.23.3720	KT 1340

#### 35-12 (13110131, 13110211, 13110231, 13110311, 13110312...)

2499 ccm	85 kW	8140.47.2700	01.90 - 04.96	AC-C	FROM MTR-NO: 1927816	AVX 10 x 875
				AC-C	UNTIL MTR-NO: 1927815	AVX 10 x 850
				ALT		AVX 10 x 925
				ALT	+ AC	AVX 10 x 1075 TM
				CAM	FROM MTR-NO: 1307401	KT 1217
				CAM	UNTIL MTR-NO: 1307400	KT 1098

#### 35-12 (15130311, 15130411, 15131111, 15131204, 15131211...)

2798 ccm	90 kW	8140.43.	05.96 - 05.99	AC-C		AVX 13 x 890
				ALT		AVX 10 x 940
				ALT	+ AC	AVX 10 x 1050
				ALT	AMP: 85	AVX 10 x 925
				W-P		AVX 13 x 800 TM
				W-P	OPT	AVX 13 x 800
				CAM	MTR-CODE: 8140.43.3711	KT 1340

#### 40-10 W 4x4

2798 ccm	76 kW	8140.23.	01.97 - 05.99	CAM	MTR-CODE: 8140.23.3720	KT 1340
----------	-------	----------	---------------	-----	------------------------	---------

#### 40-12

2499 ccm	85 kW	8140.47.2700	10.90 - 04.96	CAM	FROM MTR-NO: 1307401	KT 1217
				CAM	UNTIL MTR-NO: 1307400	KT 1098

#### 45-10 (13031204, 13031211, 13031212, 13031224, 13031231...)

2499 ccm	76 kW	8140.27.2720	01.89 - 04.96	AC-C	UNTIL MTR-NO: 1927815	AVX 10 x 850
				ALT		AVX 10 x 925
				ALT	+ AC	AVX 10 x 1075 TM
				CAM	UNTIL MTR-NO: 1307400	ZRK 1102
				CAM	FROM MTR-NO: 1307401	KT 1217
				CAM	UNTIL MTR-NO: 1307400	KT 1098

#### 49-10 (13050211, 13050231, 13050304, 13050311, 13050331...)

2499 ccm	76 kW	8140.27.2700;8140.47R.2790	01.89 - 04.96	AC-C	UNTIL MTR-NO: 1927815	AVX 10 x 850
				ALT		AVX 10 x 925
				ALT	+ AC	AVX 10 x 1075 TM
				CAM	FROM MTR-NO: 1307401	ZRK 1316
				CAM	UNTIL MTR-NO: 1307400; MTR-CODE: 814027	ZRK 1102
				CAM	FROM MTR-NO: 1307401	KT 1217
				CAM	UNTIL MTR-NO: 1307400	KT 1098

#### 49-10 (15050304, 15050404, 15050411, 15051204, 15051211...)

2798 ccm	76 kW	8140.23.	05.96 - 05.99	AC-C		AVX 13 x 890
				ALT		AVX 10 x 940
				ALT	+ AC	AVX 10 x 1050
				ALT	AMP: 85	AVX 10 x 925
				W-P		AVX 13 x 800 TM
				W-P	OPT	AVX 13 x 800
				CAM	MTR-CODE: 8140.23.3720	KT 1340

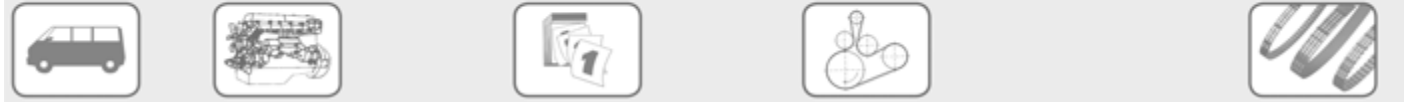

## IVECO

### DAILY II Pritsche/Fahrgestell

#### 49-12 (13130211, 13130231, 13130304, 13130311, 13130312...)

2499 ccm	85 kW	8140.47.2711;8140.47.2721	06.90 - 04.96	AC-C	UNTIL MTR-NO: 1927815	AVX 10 x 850
				ALT		AVX 10 x 925
				ALT	+ AC	AVX 10 x 1075 TM
				CAM	FROM MTR-NO: 1307401	KT 1217
				CAM	UNTIL MTR-NO: 1307400	KT 1098

#### 49-12 (15150211, 15150311, 15150404, 15150411, 15151204...)

2798 ccm	90 kW	8140.43.	05.96 - 05.99	AC-C		AVX 13 x 890
				ALT		AVX 10 x 940
				ALT	+ AC	AVX 10 x 1050
				ALT	AMP: 85	AVX 10 x 925
				W-P		AVX 13 x 800 TM
				W-P	OPT	AVX 13 x 800
				CAM	MTR-CODE: 8140.43.3711	KT 1340

#### 59-12 (13150204, 13150211, 13150231, 13150311, 13150312...)

2499 ccm	85 kW	8140.47.2700;8140.47.2711	05.91 - 04.96	AC-C	UNTIL MTR-NO: 1927815	AVX 10 x 850
				ALT		AVX 10 x 925
				ALT	+ AC	AVX 10 x 1075 TM
				CAM	FROM MTR-NO: 1307401	KT 1217
				CAM	UNTIL MTR-NO: 1307400	KT 1098

#### 59-12 (15170211, 15170304, 15170311, 15170504, 15170511...)

2798 ccm	90 kW	8140.43.	05.96 - 05.99	AC-C		AVX 13 x 890
				ALT		AVX 10 x 940
				ALT	+ AC	AVX 10 x 1050
				ALT	AMP: 85	AVX 10 x 925
				W-P		AVX 13 x 800 TM
				W-P	OPT	AVX 13 x 800
				CAM	MTR-CODE: 8140.43.3711	KT 1340

### DAILY III Kasten/Kombi

#### 29 L 9 V

2798 ccm	62 kW	8140.63.	05.99 -	CAM		ZRK 1316
				CAM		KT 1217

#### 29 L 10 V (ALJA43A2, ALJA42A2, ALJA41A2)

2287 ccm	70 kW	F1AE0481A	09.02 -	CAM		ZRK 1596
				CAM		KT 1527

#### 29 L 11 V

2798 ccm	78 kW	8140.43C	05.99 -	CAM	OE-NO.: 99456476	ZRK 1312
				CAM	OE-NO.: 99456477	ZRK 1332
				CAM	OE-NO.: 99456476	KT 1229
				CAM	OE-NO.: 99456477	KT 1340

#### 29 L 13

2798 ccm	92 kW	8140.43S	05.01 -	CAM		ZRK 1312
				CAM		KT 1229

#### 35 S 9 V,35 C 9 V

2798 ccm	62 kW	8140.63.	05.99 -	CAM		ZRK 1316
				CAM		KT 1217

#### 35 S 10 (ANJA41A1, ANJA42A2, ANJA42AB, ANJA43A, ANJAV1A...)

2287 ccm	70 kW	F1AE0481A	09.02 -	CAM		ZRK 1596
				CAM		KT 1527

#### 35 S 11 V,35 C 11 V

2798 ccm	78 kW	8140.43C	05.99 -	CAM	OE-NO.: 99456476	ZRK 1312
				CAM	OE-NO.: 99456477	ZRK 1332
				CAM	OE-NO.: 99456476	KT 1229
				CAM	OE-NO.: 99456477	KT 1340

#### 35 S 13 V,35 C 13 V

2798 ccm	92 kW	8140.43S	05.99 -	CAM		ZRK 1312
				CAM		KT 1229

#### 35 S 15 V, 35 C 15 V (A6HCV3B2, A6HBV4B2, A6HC41B2...)

2798 ccm	107 kW	8140.43N	11.02 -	CAM		ZRK 1312
				CAM		KT 1229

#### 50 C 11

2798 ccm	78 kW	8140.43C	05.99 -	CAM	OE-NO.: 99456476	ZRK 1312
				CAM	OE-NO.: 99456477	ZRK 1332
				CAM	OE-NO.: 99456476	KT 1229
				CAM	OE-NO.: 99456477	KT 1340



## IVECO

### DAILY III Kasten/Kombi

#### 50 C 13

2798 ccm	92 kW	8140.43S	05.99 -	CAM	ZRK 1312
				CAM	KT 1229

### DAILY III Pritsche/Fahrgestell

#### 29 L 9

2798 ccm	62 kW	8140.63.	05.99 -	CAM	ZRK 1316
				CAM	KT 1217

#### 29 L 10 (ALJAV1A1, ALJA41AA, ALJA41A1, AHJA64A1...)

2287 ccm	70 kW	F1AE0481A	09.02 -	CAM	ZRK 1596
				CAM	KT 1527

#### 29 L 11

2798 ccm	78 kW	8140.43B;8140.43C	05.99 -	CAM	OE-NO.: 99456476	ZRK 1312
				CAM	OE-NO.: 99456477	ZRK 1332
				CAM	OE-NO.: 99456476	KT 1229
				CAM	OE-NO.: 99456477	KT 1340

#### 29 L 13

2798 ccm	92 kW	8140.43S	11.01 -	CAM	ZRK 1312
				CAM	KT 1229

#### 35 C 10 V , 35 S 10 V (AMJA11A1, AMJA14A1, AMJA64A1...)

2287 ccm	70 kW	F1AE0481A	09.02 -	CAM	ZRK 1596
				CAM	KT 1527

#### 35 C 15

2798 ccm	107 kW	8140.43N	11.01 -	CAM	ZRK 1312
				CAM	KT 1229

#### 35 S 9,35 C 9

2798 ccm	62 kW	8140.63.	05.99 -	CAM	ZRK 1316
				CAM	KT 1217

#### 35 S 11,35 C 11 (A2FC13AA, A6FBU4AB, A2NB14A1, A2ND13A1...)

2798 ccm	78 kW	8140.43C	05.99 -	CAM	OE-NO.: 99456476	ZRK 1312
				CAM	OE-NO.: 99456477	ZRK 1332
				CAM	OE-NO.: 99456476	KT 1229
				CAM	OE-NO.: 99456477	KT 1340

#### 35 S 13,35 C 13

2798 ccm	92 kW	8140.43S	05.99 -	CAM	ZRK 1312
				CAM	KT 1229

#### 50 C 11

2798 ccm	78 kW	8140.43C	05.99 -	CAM	OE-NO.: 99456476	ZRK 1312
				CAM	OE-NO.: 99456477	ZRK 1332
				CAM	OE-NO.: 99456476	KT 1229
				CAM	OE-NO.: 99456477	KT 1340

#### 50 C 13

2798 ccm	92 kW	8140.43S	05.99 -	CAM	ZRK 1312
				CAM	KT 1229

#### 50 C 15

2798 ccm	107 kW	8140.43N	01.01 -	CAM	ZRK 1312
				CAM	KT 1229

#### 65 C 15

2798 ccm	107 kW	8140.43N	11.01 -	CAM	ZRK 1312
				CAM	KT 1229

### DAILY IV Kasten/Kombi

#### 29L10 V

2287 ccm	70 kW	F1AE0481FA	05.06 -	CAM	ZRK 1596
				CAM	KT 1527

#### 35C10, 35S10

2287 ccm	70 kW	F1AE0481FA	05.06 -	CAM	ZRK 1596
				CAM	KT 1527

#### 40C10 V

2287 ccm	70 kW	F1AE0481FA	05.06 -	CAM	ZRK 1596
				CAM	KT 1527

### DAILY IV Kipper

#### 35C10 K

2287 ccm	70 kW	F1AE0481FA	05.06 -	CAM	ZRK 1596
				CAM	KT 1527



## IVECO

### DAILY IV Pritsche/Fahrgestell

<b>29L10</b>						
2287 ccm	70 kW	F1AE0481FA	05.06 -	CAM		ZRK 1596
				CAM		KT 1527
<b>35C10, 35S10</b>						
2287 ccm	70 kW	F1AE0481FA	05.06 -	CAM		ZRK 1596
				CAM		KT 1527
<b>40C10</b>						
2287 ccm	70 kW	F1AE0481FA	05.06 -	CAM		ZRK 1596
				CAM		KT 1527

## KIA

### BONGO Bus

<b>2.4 TDCi</b>						
2477 ccm	69 kW	D4BH	10.03 -	PS		4 PK 1060
<b>2.9 TDiC</b>						
2902 ccm	90 kW		10.03 -	ALT		5 PK 1590

### BONGO Großraumlimousine

<b>2.4 TDCi</b>						
2477 ccm	69 kW	D4BH	10.03 -	PS		4 PK 1060
<b>2.9 TDiC</b>						
2902 ccm	90 kW		10.03 -	ALT		5 PK 1590
<b>2.9 TDiC 4WD</b>						
2902 ccm	90 kW		10.03 -	ALT		5 PK 1590

### BONGO Pritsche/Fahrgestell

<b>2.4 TDCi</b>						
2477 ccm	69 kW	D4BH	10.03 -	PS		4 PK 1060
<b>2.9 TDiC</b>						
2902 ccm	90 kW		10.03 -	ALT		5 PK 1590
<b>2.9 TDiC 4WD</b>						
2902 ccm	90 kW		10.03 -	ALT		5 PK 1590

### PREGIO Bus

<b>2.5 D</b>						
2477 ccm	69 kW	D4BH	08.95 - 09.04	PS	FROM: 08.96	4 PK 1060
				BAL		ZRK 1202
				CAM		ZRK 1522
				BAL		KT 1391
				CAM		KT 1488

### PREGIO Kasten (TB)

<b>2.5 TCI D</b>						
2476 ccm	69 kW	D4BH	09.02 -	PS		4 PK 1060
				BAL		ZRK 1202
				CAM		ZRK 1522
				BAL		KT 1391
				CAM		KT 1488

## LDV

### CONVOY Kasten

<b>2.4 D</b>						
2402 ccm	55 kW	F4FA	03.02 - 04.09	ALT	- AC	7 PK 2710 TM
				ALT	+ AC	7 PK 2875 TM
<b>2.4 D</b>						
2402 ccm	66 kW	D2FA	03.02 - 04.09	ALT	- AC	7 PK 2710 TM
				ALT	+ AC	7 PK 2875 TM

### 400 Pritsche/Fahrgestell

<b>2.5 TD</b>						
2498 ccm	71 kW	ET 70	11.95 - 10.96	AIR-C	UNTIL: 03.96; MTR-CODE: ET70; MOD: VA431;VA435;VD431; + PS	AVX 13 x 1025 TM
				PS	UNTIL: 03.96; MTR-CODE: ET70; MOD: VA431;VA435;VD431; + PS	AVX 13 x 1025



## MAZDA

### E-SERIE Kasten (SR2)

#### E2000

1998 ccm	60 kW	FE;FE60;FE61	03.91 - 05.94	PS PS CAM CAM	AWD	AVX 13 x 775 AVX 13 x 825 ZRK 1335 KT 1184
----------	-------	--------------	---------------	------------------------	-----	---

#### E2000

1998 ccm	63 kW	FE18;FE58	05.85 - 04.89	PS PS CAM CAM CAM CAM CAM	AWD FROM: 07.85; UNTIL: 11.87 FROM: 12.87 UNTIL: 06.85 FROM: 07.85; UNTIL: 11.87 FROM: 12.87	AVX 13 x 775 AVX 13 x 825 ZRK 1335 ZRK 1167 ZRK 1120 KT 1184 KT 1163
----------	-------	-----------	---------------	---	---	--

#### E2000

1998 ccm	70 kW	FE	06.94 - 05.03	PS PS CAM	AWD	AVX 13 x 775 AVX 13 x 825 ZRK 1167
----------	-------	----	---------------	-----------------	-----	--

#### E2200 D

2184 ccm	46 kW	R203;R207	05.85 - 02.88	CAM		ZRK 1264
----------	-------	-----------	---------------	-----	--	----------

#### E2200 D

2184 ccm	47 kW	R203;R207	03.91 - 05.03	CAM		ZRK 1264
----------	-------	-----------	---------------	-----	--	----------

#### 2200 D 4WD

2184 ccm	47 kW	R203;R207	03.91 - 05.03	CAM		ZRK 1264
----------	-------	-----------	---------------	-----	--	----------

#### E2200 D

2184 ccm	52 kW	R2	02.97 - 08.02	CAM		ZRK 1225
----------	-------	----	---------------	-----	--	----------

### E-SERIE Großraumlimousine (SG)

#### 2.0 i (SGE3, SGEW)

1998 ccm	74 kW	FE (12V)	08.99 - 10.01	ALT PS		4 PK 925 4 PK 980
----------	-------	----------	---------------	-----------	--	----------------------

#### 2.5 i

2499 ccm	96 kW		08.99 - 10.01	ALT PS		4 PK 925 4 PK 980
----------	-------	--	---------------	-----------	--	----------------------

## MERCEDES-BENZ

### UNIMOG

#### 90

2874 ccm	65 kW	OM 602.941	11.92 -	HYD-P HYD-P ALT ALT	MOD: U 90 MOD: U 90 MOD: U90; - AC MOD: U90; + AC; + EXT-HEAT	AVX 13 x 1375 AVX 13 x 1375 TM 6 PK 2080 6 PK 2257
----------	-------	------------	---------	------------------------------	--	---

#### 100H; 100M

2874 ccm	80 kW	OM 602.981;OM 602.989	09.96 -	FAN FAN ALT ALT ALT ALT ALT	MTR-CODE: OM 602.981; MOD: UX 100H;UX 100M MTR-CODE: OM 602.981; MOD: UX 100H;UX 100M MOD: UX100H,UX100M MOD: UX100H,UX100M; - AC MOD: UX100H,UX100M; - AC MOD: UX100H,UX100M; + AC; - EXT-HEAT OE-NO.: 0089977092; MOD: UX100H,UX100M; + AC OE-NO.: 68465; MOD: UX100H,UX100M; + AC; + EXT-HEAT	AVX 13 x 1500 AVX 13 x 1500 TM 6 PK 2080 6 PK 2080 6 PK 2100 6 PK 2050 6 PK 2257 6 PK 2245
----------	-------	-----------------------	---------	---	---	---

#### 110; 110L

3973 ccm	75 kW	OM 364.955;OM 364.958	02.92 -	AIR-C AIR-C ALT ALT PS PS	MTR-CODE: OM 364.955; MOD: U 110;U 110L; REQ: 2 MTR-CODE: OM 364.955; MOD: U 110;U 110L; REQ: 2 MTR-CODE: OM 364.955; MOD: U 110;U 110L; REQ: 2 MTR-CODE: OM 364.955; MOD: U 110;U 110L; REQ: 2 FROM MTR-NO: 388692; MTR-CODE: OM 364.955; MOD: U 110;U 110L FROM MTR-NO: 388692; MTR-CODE: OM 364.955; MOD: U 110;U 110L	AVX 13 x 1025 AVX 13 x 1025 TM AVX 13 x 1275 AVX 13 x 1275 TM AVX 13 x 950 AVX 13 x 950 TM
----------	-------	-----------------------	---------	--	--	---



## MERCEDES-BENZ

### UNIMOG

#### 110; 110L

3973 ccm	75 kW	OM 364.955;OM 364.958	02.92 -	PS	UNTIL MTR-NO: 388691; MTR-CODE: OM 364.955; MOD: U 110;U 110L	<b>AVX 13 x 1000</b>
				PS	UNTIL MTR-NO: 388691; MTR-CODE: OM 364.955; MOD: U 110;U 110L	<b>AVX 13 x 1000 TM</b>

#### 100L

2874 ccm	85 kW	OM 602.981;OM 602.989	07.96 -	ALT	MOD: U100L; - AC	<b>6 PK 2080</b>
				ALT	MOD: U100L; - AC	<b>6 PK 2100</b>
				ALT	MOD: U100L; + AC; - EXT-HEAT	<b>6 PK 2050</b>
				ALT	OE-NO.: 0089977092; MOD: U100L; + AC	<b>6 PK 2257</b>
				ALT	OE-NO.: 68465; MOD: U100L; + AC; + EXT-HEAT	<b>6 PK 2245</b>

#### 130; 140

3972 ccm	98 kW	OM 364.982;OM 364.985	07.92 -	AIR-C	MTR-CODE: OM 364.982; MOD: U 130;U 140;U 140L; REQ: 2	<b>AVX 13 x 1025</b>
				AIR-C	MTR-CODE: OM 364.982; MOD: U 130;U 140;U 140L; REQ: 2	<b>AVX 13 x 1025 TM</b>
				ALT	MTR-CODE: OM 364.982; MOD: U 130;U 140;U 140L; REQ: 2	<b>AVX 13 x 1275</b>
				ALT	MTR-CODE: OM 364.982; MOD: U 130;U 140;U 140L; REQ: 2	<b>AVX 13 x 1275 TM</b>
				PS	UNTIL MTR-NO: 388691; MTR-CODE: OM 364.982; MOD: U 130;U 140;U 140L	<b>AVX 13 x 1000</b>
				PS	UNTIL MTR-NO: 388691; MTR-CODE: OM 364.982; MOD: U 130;U 140;U 140L	<b>AVX 13 x 1000 TM</b>
				S-PUL	MTR-CODE: OM 364.982; MOD: U 130;U 140;U 140L	<b>AVX 13 x 1125</b>
				S-PUL	MTR-CODE: OM 364.982; MOD: U 130;U 140;U 140L	<b>AVX 13 x 1125 TM</b>

#### 140T

3972 ccm	98 kW	OM 364.982	07.92 -	AIR-C	MOD: U 130;U 140;U 140L; REQ: 2	<b>AVX 13 x 1025</b>
				AIR-C	MOD: U 130;U 140;U 140L; REQ: 2	<b>AVX 13 x 1025 TM</b>
				ALT	MOD: U 130;U 140;U 140L; REQ: 2	<b>AVX 13 x 1275</b>
				ALT	MOD: U 130;U 140;U 140L; REQ: 2	<b>AVX 13 x 1275 TM</b>
				PS	UNTIL MTR-NO: 388691; MOD: U 130;U 140;U 140L	<b>AVX 13 x 1000</b>
				PS	UNTIL MTR-NO: 388691; MOD: U 130;U 140;U 140L	<b>AVX 13 x 1000 TM</b>
				S-PUL	MOD: U 130;U 140;U 140L	<b>AVX 13 x 1125</b>
				S-PUL	MOD: U 130;U 140;U 140L	<b>AVX 13 x 1125 TM</b>

#### 140L

3972 ccm	100 kW	OM 364.985	07.92 -	AIR-C	MTR-CODE: OM 364.982; MOD: U 130;U 140;U 140L; REQ: 2	<b>AVX 13 x 1025</b>
				AIR-C	MTR-CODE: OM 364.982; MOD: U 130;U 140;U 140L; REQ: 2	<b>AVX 13 x 1025 TM</b>
				ALT	MTR-CODE: OM 364.982; MOD: U 130;U 140;U 140L; REQ: 2	<b>AVX 13 x 1275</b>
				ALT	MTR-CODE: OM 364.982; MOD: U 130;U 140;U 140L; REQ: 2	<b>AVX 13 x 1275 TM</b>
				HYD-P	UNTIL MTR-NO: 388691; MTR-CODE: OM 364.982; MOD: U 130;U 140;U 140L	<b>AVX 13 x 1000</b>
				HYD-P	UNTIL MTR-NO: 388691; MTR-CODE: OM 364.982; MOD: U 130;U 140;U 140L	<b>AVX 13 x 1000 TM</b>
				S-PUL	MTR-CODE: OM 364.982; MOD: U 130;U 140;U 140L	<b>AVX 13 x 1125</b>
				S-PUL	MTR-CODE: OM 364.982; MOD: U 130;U 140;U 140L	<b>AVX 13 x 1125 TM</b>

#### 60T; 600T

2404 ccm	38 kW	OM 616.911;OM 616.915;OM 616.931;OM 616.932	01.77 -	FAN	FROM MTR-NO: 2787; MTR-CODE: OM 616.911; MOD: U 600T;U 60T; U 600T	<b>AVX 13 x 1450</b>
				FAN	FROM MTR-NO: 2787; MTR-CODE: OM 616.911; MOD: U 600T;U 60T; U 600T	<b>AVX 13 x 1450 TM</b>
				HYD-P	MTR-CODE: OM 616.911; MOD: U 600T;U 60T; U 600T	<b>AVX 13 x 1000</b>
				HYD-P	MTR-CODE: OM 616.911; MOD: U 600T;U 60T; U 600T	<b>AVX 13 x 1000 TM</b>
				PS	MTR-CODE: OM 616.911; MOD: U 600T;U 60T; U 600T	<b>AVX 13 x 750</b>
				PS	MTR-CODE: OM 616.911; MOD: U 600T;U 60T; U 600T	<b>AVX 13 x 750 TM</b>
				PS	UNTIL MTR-NO: 2786; MTR-CODE: OM 616.911; MOD: U 600T;U 60T; U 600T	<b>AVX 13 x 925</b>



## MERCEDES-BENZ

### UNIMOG

#### 60T; 600T

2404 ccm	38 kW	OM 616.911;OM 616.915;OM 616.931;OM 616.932	01.77 -	PS	UNTIL MTR-NO: 2786; MTR-CODE: OM 616.911; MOD: U 600T;U 60T; U 600T	AVX 13 x 925 TM
----------	-------	---	---------	----	---	-----------------

#### 52; 60; 600; 600L

2404 ccm	38 kW	OM 616.911;OM 616.915;OM 616.931;OM 616.932	01.77 -	FAN	FROM MTR-NO: 2787; MTR-CODE: OM 616.911; MOD: U 600;U 600L	AVX 13 x 1450
				FAN	FROM MTR-NO: 2787; MTR-CODE: OM 616.911; MOD: U 600;U 600L	AVX 13 x 1450 TM
				HYD-P	MTR-CODE: OM 616.911; MOD: U 600;U 600L	AVX 13 x 1000
				HYD-P	MTR-CODE: OM 616.911; MOD: U 600;U 600L	AVX 13 x 1000 TM
				PS	FROM MTR-NO: 2788; MTR-CODE: OM 616.911; MOD: U 52	AVX 13 x 925
				PS	FROM MTR-NO: 2788; MTR-CODE: OM 616.911; MOD: U 52	AVX 13 x 925 TM
				PS	MTR-CODE: OM 616.911; MOD: U 600;U 600L	AVX 13 x 750
				PS	MTR-CODE: OM 616.911; MOD: U 600;U 600L	AVX 13 x 750 TM
				PS	UNTIL MTR-NO: 2786; MTR-CODE: OM 616.911; MOD: U 600;U 600L	AVX 13 x 925
				PS	UNTIL MTR-NO: 2786; MTR-CODE: OM 616.911; MOD: U 600;U 600L	AVX 13 x 925 TM
				PS	UNTIL MTR-NO: 2787; MTR-CODE: OM 616.911; MOD: U 52	AVX 13 x 950
				PS	UNTIL MTR-NO: 2787; MTR-CODE: OM 616.911; MOD: U 52	AVX 13 x 950 TM

#### 600

2399 ccm	38 kW	OM 616.942;OM 616.943	05.88 -	HYD-P	MTR-CODE: OM 616.942; MOD: U 600	AVX 13 x 1000
				HYD-P	MTR-CODE: OM 616.942; MOD: U 600	AVX 13 x 1000 TM
				PS	FROM MTR-NO: 2787; MTR-CODE: OM 616.942; MOD: U 600	AVX 13 x 950
				PS	FROM MTR-NO: 2787; MTR-CODE: OM 616.942; MOD: U 600	AVX 13 x 950 TM
				PS	MTR-CODE: OM 616.942; MOD: U 600	AVX 13 x 750
				PS	MTR-CODE: OM 616.942; MOD: U 600	AVX 13 x 750 TM
				PS	UNTIL MTR-NO: 2786; MTR-CODE: OM 616.942; MOD: U 600	AVX 13 x 925
				PS	UNTIL MTR-NO: 2786; MTR-CODE: OM 616.942; MOD: U 600	AVX 13 x 925 TM

#### 600

2399 ccm	38 kW	OM 616.942;OM 616.943	05.88 -	HYD-P	MTR-CODE: OM 616.942; MOD: U 600	AVX 13 x 1000
				HYD-P	MTR-CODE: OM 616.942; MOD: U 600	AVX 13 x 1000 TM
				PS	FROM MTR-NO: 2787; MTR-CODE: OM 616.942; MOD: U 600	AVX 13 x 950
				PS	FROM MTR-NO: 2787; MTR-CODE: OM 616.942; MOD: U 600	AVX 13 x 950 TM
				PS	MTR-CODE: OM 616.942; MOD: U 600	AVX 13 x 750
				PS	MTR-CODE: OM 616.942; MOD: U 600	AVX 13 x 750 TM
				PS	UNTIL MTR-NO: 2786; MTR-CODE: OM 616.942; MOD: U 600	AVX 13 x 925
				PS	UNTIL MTR-NO: 2786; MTR-CODE: OM 616.942; MOD: U 600	AVX 13 x 925 TM

#### 650; 650L

2399 ccm	38 kW	OM 616.942;OM 616.943	05.88 -	PS	FROM MTR-NO: 2788; MTR-CODE: OM 616.942; MOD: U 650;U 650L	AVX 13 x 925
				PS	FROM MTR-NO: 2788; MTR-CODE: OM 616.942; MOD: U 650;U 650L	AVX 13 x 925 TM
				PS	UNTIL MTR-NO: 2787; MTR-CODE: OM 616.942; MOD: U 650;U 650L	AVX 13 x 950
				PS	UNTIL MTR-NO: 2787; MTR-CODE: OM 616.942; MOD: U 650;U 650L	AVX 13 x 950 TM

#### 650; 650L

2399 ccm	38 kW	OM 616.942;OM 616.943	05.88 -	PS	FROM MTR-NO: 2788; MTR-CODE: OM 616.942; MOD: U 650;U 650L	AVX 13 x 925
				PS	FROM MTR-NO: 2788; MTR-CODE: OM 616.942; MOD: U 650;U 650L	AVX 13 x 925 TM
				PS	UNTIL MTR-NO: 2787; MTR-CODE: OM 616.942; MOD: U 650;U 650L	AVX 13 x 950
				PS	UNTIL MTR-NO: 2787; MTR-CODE: OM 616.942; MOD: U 650;U 650L	AVX 13 x 950 TM

#### 800

3780 ccm	53 kW	OM 314.917	01.77 -	ALT	MOD: U 800;U 800L	AVX 13 x 1200
				ALT	MOD: U 800;U 800L	AVX 13 x 1200 TM
				PS	MOD: U 800;U 800L	AVX 13 x 900



## MERCEDES-BENZ

### UNIMOG

<b>800</b>							
3780 ccm	53 kW	OM 314.917	01.77 -	PS	MOD: U 800;U 800L		<b>AVX 13 x 900 TM</b>
<b>800L</b>							
3780 ccm	53 kW	OM 314.917	01.77 -	ALT	MOD: U 800;U 800L		<b>AVX 13 x 1200</b>
				ALT	MOD: U 800;U 800L		<b>AVX 13 x 1200 TM</b>
				PS	MOD: U 800;U 800L		<b>AVX 13 x 900</b>
				PS	MOD: U 800;U 800L		<b>AVX 13 x 900 TM</b>
<b>800</b>							
3780 ccm	53 kW	OM 314.917	05.88 -	ALT	MOD: U 800;U 800L		<b>AVX 13 x 1200</b>
				ALT	MOD: U 800;U 800L		<b>AVX 13 x 1200 TM</b>
				PS	MOD: U 800;U 800L		<b>AVX 13 x 900</b>
				PS	MOD: U 800;U 800L		<b>AVX 13 x 900 TM</b>
<b>1000</b>							
5958 ccm	75 kW	OM 356.914;OM 366.915	01.88 -	AIR-C	MTR-CODE: OM 356.914;OM 366.915; MOD: U 1000		<b>AVX 13 x 1125</b>
				AIR-C	MTR-CODE: OM 356.914;OM 366.915; MOD: U 1000		<b>AVX 13 x 1125 TM</b>
				FAN	MTR-CODE: OM 356.914;OM 366.915; MOD: U 1000		<b>AVX 13 x 1275</b>
				FAN	MTR-CODE: OM 356.914;OM 366.915; MOD: U 1000		<b>AVX 13 x 1275 TM</b>
				FAN	MTR-CODE: OM 356.914;OM 366.915; MOD: U 1000		<b>AVX 13 x 1550</b>
				FAN	MTR-CODE: OM 356.914;OM 366.915; MOD: U 1000		<b>AVX 13 x 1550 TM</b>
				PS	MTR-CODE: OM 356.914;OM 366.915; MOD: U 1000		<b>AVX 13 x 900</b>
				PS	MTR-CODE: OM 356.914;OM 366.915; MOD: U 1000		<b>AVX 13 x 900 TM</b>
<b>1200T</b>							
5958 ccm	92 kW	OM 356.954;OM 366.949	01.88 -	AIR-C	MTR-CODE: OM 356.950;OM 366.949; MOD: U 1200;U 1200T		<b>AVX 13 x 1125</b>
				AIR-C	MTR-CODE: OM 356.950;OM 366.949; MOD: U 1200;U 1200T		<b>AVX 13 x 1125 TM</b>
				FAN	MTR-CODE: OM 356.950;OM 366.949; MOD: U 1200;U 1200T		<b>AVX 13 x 1275</b>
				FAN	MTR-CODE: OM 356.950;OM 366.949; MOD: U 1200;U 1200T		<b>AVX 13 x 1275 TM</b>
				FAN	MTR-CODE: OM 356.950;OM 366.949; MOD: U 1200;U 1200T		<b>AVX 13 x 1625</b>
				FAN	MTR-CODE: OM 356.950;OM 366.949; MOD: U 1200;U 1200T		<b>AVX 13 x 1625 TM</b>
				PS	MTR-CODE: OM 356.950;OM 366.949; MOD: U 1200;U 1200T		<b>AVX 13 x 975</b>
				PS	MTR-CODE: OM 356.950;OM 366.949; MOD: U 1200;U 1200T		<b>AVX 13 x 975 TM</b>
<b>1200</b>							
5958 ccm	92 kW	OM 356.950;OM 356.954;OM 366.949	01.88 -	AIR-C	MTR-CODE: OM 356.950;OM 366.949; MOD: U 1200;U 1200T		<b>AVX 13 x 1125</b>
				AIR-C	MTR-CODE: OM 356.950;OM 366.949; MOD: U 1200;U 1200T		<b>AVX 13 x 1125 TM</b>
				FAN	MTR-CODE: OM 356.950;OM 366.949; MOD: U 1200;U 1200T		<b>AVX 13 x 1275</b>
				FAN	MTR-CODE: OM 356.950;OM 366.949; MOD: U 1200;U 1200T		<b>AVX 13 x 1275 TM</b>
				FAN	MTR-CODE: OM 356.950;OM 366.949; MOD: U 1200;U 1200T		<b>AVX 13 x 1625</b>
				FAN	MTR-CODE: OM 356.950;OM 366.949; MOD: U 1200;U 1200T		<b>AVX 13 x 1625 TM</b>
				PS	MTR-CODE: OM 356.950;OM 366.949; MOD: U 1200;U 1200T		<b>AVX 13 x 975</b>
				PS	MTR-CODE: OM 356.950;OM 366.949; MOD: U 1200;U 1200T		<b>AVX 13 x 975 TM</b>
<b>1250; 1250L</b>							
5958 ccm	92 kW	OM 356.950;OM 356.954;OM 366.949	01.88 -	AIR-C	MTR-CODE: OM 356.950;OM 366; MOD: U 1250;U 1250L		<b>AVX 13 x 1125</b>
				AIR-C	MTR-CODE: OM 356.950;OM 366; MOD: U 1250;U 1250L		<b>AVX 13 x 1125 TM</b>
				FAN	MTR-CODE: OM 356.950;OM 366; MOD: U 1250;U 1250L		<b>AVX 13 x 1275</b>
				FAN	MTR-CODE: OM 356.950;OM 366; MOD: U 1250;U 1250L		<b>AVX 13 x 1275 TM</b>





## MERCEDES-BENZ

### UNIMOG

#### 1250; 1250L

5958 ccm	92 kW	OM 356.950;OM 356.954;OM 366.949	01.88 -	FAN	MTR-CODE: OM 356.950;OM 366; MOD: U 1250;U 1250L	AVX 13 x 1625
				FAN	MTR-CODE: OM 356.950;OM 366; MOD: U 1250;U 1250L	AVX 13 x 1625 TM
				PS	MTR-CODE: OM 356.950;OM 366; MOD: U 1250;U 1250L	AVX 13 x 975
				PS	MTR-CODE: OM 356.950;OM 366; MOD: U 1250;U 1250L	AVX 13 x 975 TM

#### 1250L

5958 ccm	100 kW	OM 366.955	05.88 -	AIR-C	MTR-CODE: OM 356.950;OM 366; MOD: U 1250;U 1250L	AVX 13 x 1125
				AIR-C	MTR-CODE: OM 356.950;OM 366; MOD: U 1250;U 1250L	AVX 13 x 1125 TM
				FAN	MTR-CODE: OM 356.950;OM 366; MOD: U 1250;U 1250L	AVX 13 x 1275
				FAN	MTR-CODE: OM 356.950;OM 366; MOD: U 1250;U 1250L	AVX 13 x 1275 TM
				FAN	MTR-CODE: OM 356.950;OM 366; MOD: U 1250;U 1250L	AVX 13 x 1625
				FAN	MTR-CODE: OM 356.950;OM 366; MOD: U 1250;U 1250L	AVX 13 x 1625 TM
				PS	MTR-CODE: OM 356.950;OM 366; MOD: U 1250;U 1250L	AVX 13 x 975
				PS	MTR-CODE: OM 356.950;OM 366; MOD: U 1250;U 1250L	AVX 13 x 975 TM

#### 1350L

5958 ccm	100 kW	OM 366.955	05.88 -	AC-C	UNTIL MTR-NO: 392287; OE-NO.: 0039970792; MOD: U 1350L	AVX 13 x 1250
				AC-C	UNTIL MTR-NO: 392287; OE-NO.: 0039970792; MOD: U 1350L	AVX 13 x 1250 TM
				AIR-C	OE-NO.: 0049976992; MOD: U 1350L	AVX 13 x 1125
				AIR-C	OE-NO.: 0049976992; MOD: U 1350L	AVX 13 x 1125 TM
				FAN	FROM MTR-NO: 392288; OE-NO.: 0049971292; MOD: U 1350L	AVX 13 x 1275
				FAN	FROM MTR-NO: 392288; OE-NO.: 0049971292; MOD: U 1350L	AVX 13 x 1275 TM
				FAN	OE-NO.: 0049976192; MOD: U 1350L	AVX 13 x 1625
				FAN	OE-NO.: 0049976192; MOD: U 1350L	AVX 13 x 1625 TM
				PS	OE-NO.: 0049971292; MOD: U 1350L	AVX 13 x 950
				PS	OE-NO.: 0049971292; MOD: U 1350L	AVX 13 x 950 TM
				PS	OE-NO.: 0119973192; MOD: U 1350L	AVX 13 x 975
				PS	OE-NO.: 0119973192; MOD: U 1350L	AVX 13 x 975 TM

#### 1400

5958 ccm	100 kW	OM 357.912;OM 366.947;OM 366.948;OM 366.955;OM 366.956	01.88 -	AC-C	MTR-CODE: OM 357.912; OE-NO.: 0049976992; MOD: U 1400	AVX 13 x 1125
				AC-C	MTR-CODE: OM 357.912; OE-NO.: 0049976992; MOD: U 1400	AVX 13 x 1125 TM
				AC-C	UNTIL MTR-NO: 392287; MTR-CODE: OM 357.912; OE-NO.: 0039970792; MOD: U 1400	AVX 13 x 1250
				AC-C	UNTIL MTR-NO: 392287; MTR-CODE: OM 357.912; OE-NO.: 0039970792; MOD: U 1400	AVX 13 x 1250 TM
				AIR-C	MTR-CODE: OM 357.912; OE-NO.: 0119973192; MOD: U 1400	AVX 13 x 975
				AIR-C	MTR-CODE: OM 357.912; OE-NO.: 0119973192; MOD: U 1400	AVX 13 x 975 TM
				ALT	MTR-CODE: OM 357.912; OE-NO.: 0049971292; MOD: U 1400	AVX 13 x 950
				ALT	MTR-CODE: OM 357.912; OE-NO.: 0049971292; MOD: U 1400	AVX 13 x 950 TM
				ALT	MTR-CODE: OM 357.912; OE-NO.: 0049976192; MOD: U 1400	AVX 13 x 1625
				ALT	MTR-CODE: OM 357.912; OE-NO.: 0049976192; MOD: U 1400	AVX 13 x 1625 TM
				FAN	FROM MTR-NO: 392288; MTR-CODE: OM 357.912; OE-NO.: 0049971292; MOD: U 1400	AVX 13 x 1275
				FAN	FROM MTR-NO: 392288; MTR-CODE: OM 357.912; OE-NO.: 0049971292; MOD: U 1400	AVX 13 x 1275 TM

#### 1450; 1450L

5958 ccm	100 kW	OM 357.912;OM 366.947;OM 366.948;OM 366.955;OM 366.956	01.88 -	AC-C	MTR-CODE: OM 357.912; OE-NO.: 0049976992; MOD: U 1450;U 1450L	AVX 13 x 1125
----------	--------	--	---------	------	---	---------------



## MERCEDES-BENZ

### UNIMOG

#### 1450; 1450L

5958 ccm	100 kW	OM 357.912;OM 366.947;OM 366.948;OM 366.955;OM 366.956	01.88 -	AC-C	MTR-CODE: OM 357.912; OE-NO.: 0049976992; MOD: U 1450;U 1450L	AVX 13 x 1125 TM
				AC-C	UNTIL MTR-NO: 392287; MTR-CODE: OM 357.912; OE-NO.: 0039970792; MOD: U 1450;U 1450L	AVX 13 x 1250
				AC-C	UNTIL MTR-NO: 392287; MTR-CODE: OM 357.912; OE-NO.: 0039970792; MOD: U 1450;U 1450L	AVX 13 x 1250 TM
				AIR-C	MTR-CODE: OM 357.912; OE-NO.: 0119973192; MOD: U 1450;U 1450L	AVX 13 x 975
				AIR-C	MTR-CODE: OM 357.912; OE-NO.: 0119973192; MOD: U 1450;U 1450L	AVX 13 x 975 TM
				ALT	MTR-CODE: OM 357.912; OE-NO.: 0049971292; MOD: U 1450;U 1450L	AVX 13 x 950
				ALT	MTR-CODE: OM 357.912; OE-NO.: 0049971292; MOD: U 1450;U 1450L	AVX 13 x 950 TM
				ALT	MTR-CODE: OM 357.912; OE-NO.: 0049976192; MOD: U 1450;U 1450L	AVX 13 x 1625
				ALT	MTR-CODE: OM 357.912; OE-NO.: 0049976192; MOD: U 1450;U 1450L	AVX 13 x 1625 TM
				FAN	FROM MTR-NO: 392288; MTR-CODE: OM 357.912; OE-NO.: 0049971292; MOD: U 1450;U 1450L	AVX 13 x 1275
				FAN	FROM MTR-NO: 392288; MTR-CODE: OM 357.912; OE-NO.: 0049971292; MOD: U 1450;U 1450L	AVX 13 x 1275 TM

#### 1550L

5958 ccm	100 kW	OM 366.955;OM 366.956	05.88 -	AC-C	MTR-CODE: OM 356.955; OE-NO.: 0049976992; MOD: U 1550L	AVX 13 x 1125
				AC-C	MTR-CODE: OM 356.955; OE-NO.: 0049976992; MOD: U 1550L	AVX 13 x 1125 TM
				AC-C	UNTIL MTR-NO: 392287; MTR-CODE: OM 356.955; OE-NO.: 0039970792; MOD: U 1550L	AVX 13 x 1250
				AC-C	UNTIL MTR-NO: 392287; MTR-CODE: OM 356.955; OE-NO.: 0039970792; MOD: U 1550L	AVX 13 x 1250 TM
				AIR-C	MTR-CODE: OM 356.955; OE-NO.: 0119973192; MOD: U 1550L	AVX 13 x 975
				AIR-C	MTR-CODE: OM 356.955; OE-NO.: 0119973192; MOD: U 1550L	AVX 13 x 975 TM
				ALT	MTR-CODE: OM 356.955; OE-NO.: 0049976192; MOD: U 1550L	AVX 13 x 1625
				ALT	MTR-CODE: OM 356.955; OE-NO.: 0049976192; MOD: U 1550L	AVX 13 x 1625 TM
				FAN	FROM MTR-NO: 392288; MTR-CODE: OM 356.955; OE-NO.: 0049971292; MOD: U 1550L	AVX 13 x 1275
				FAN	FROM MTR-NO: 392288; MTR-CODE: OM 356.955; OE-NO.: 0049971292; MOD: U 1550L	AVX 13 x 1275 TM

#### 1550L

5958 ccm	114 kW	OM 356.955;OM 356.956	01.92 -	AC-C	MTR-CODE: OM 356.955; OE-NO.: 0049976992; MOD: U 1550L	AVX 13 x 1125
				AC-C	MTR-CODE: OM 356.955; OE-NO.: 0049976992; MOD: U 1550L	AVX 13 x 1125 TM
				AC-C	UNTIL MTR-NO: 392287; MTR-CODE: OM 356.955; OE-NO.: 0039970792; MOD: U 1550L	AVX 13 x 1250
				AC-C	UNTIL MTR-NO: 392287; MTR-CODE: OM 356.955; OE-NO.: 0039970792; MOD: U 1550L	AVX 13 x 1250 TM
				AIR-C	MTR-CODE: OM 356.955; OE-NO.: 0119973192; MOD: U 1550L	AVX 13 x 975
				AIR-C	MTR-CODE: OM 356.955; OE-NO.: 0119973192; MOD: U 1550L	AVX 13 x 975 TM
				ALT	MTR-CODE: OM 356.955; OE-NO.: 0049976192; MOD: U 1550L	AVX 13 x 1625
				ALT	MTR-CODE: OM 356.955; OE-NO.: 0049976192; MOD: U 1550L	AVX 13 x 1625 TM
				FAN	FROM MTR-NO: 392288; MTR-CODE: OM 356.955; OE-NO.: 0049971292; MOD: U 1550L	AVX 13 x 1275
				FAN	FROM MTR-NO: 392288; MTR-CODE: OM 356.955; OE-NO.: 0049971292; MOD: U 1550L	AVX 13 x 1275 TM

#### 1550L

5958 ccm	115 kW	OM 356.956	05.88 -	AC-C	MTR-CODE: OM 356.955; OE-NO.: 0049976992; MOD: U 1550L	AVX 13 x 1125
				AC-C	MTR-CODE: OM 356.955; OE-NO.: 0049976992; MOD: U 1550L	AVX 13 x 1125 TM

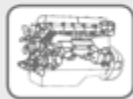

## MERCEDES-BENZ

### UNIMOG

#### 1550L

5958 ccm	115 kW	OM 356.956	05.88 -	AC-C	UNTIL MTR-NO: 392287; MTR-CODE: OM 356.955; OE-NO.: 0039970792; MOD: U 1550L	AVX 13 x 1250
				AC-C	UNTIL MTR-NO: 392287; MTR-CODE: OM 356.955; OE-NO.: 0039970792; MOD: U 1550L	AVX 13 x 1250 TM
				AIR-C	MTR-CODE: OM 356.955; OE-NO.: 0119973192; MOD: U 1550L	AVX 13 x 975
				AIR-C	MTR-CODE: OM 356.955; OE-NO.: 0119973192; MOD: U 1550L	AVX 13 x 975 TM
				ALT	MTR-CODE: OM 356.955; OE-NO.: 0049976192; MOD: U 1550L	AVX 13 x 1625
				ALT	MTR-CODE: OM 356.955; OE-NO.: 0049976192; MOD: U 1550L	AVX 13 x 1625 TM
				FAN	FROM MTR-NO: 392288; MTR-CODE: OM 356.955; OE-NO.: 0049971292; MOD: U 1550L	AVX 13 x 1275
				FAN	FROM MTR-NO: 392288; MTR-CODE: OM 356.955; OE-NO.: 0049971292; MOD: U 1550L	AVX 13 x 1275 TM

#### 1550L

5958 ccm	125 kW	OM 366.963	01.92 -	AC-C	UNTIL MTR-NO: 392287; MTR-CODE: OM 356.955; OE-NO.: 0039970792; MOD: U 1550L	AVX 13 x 1250
				AC-C	UNTIL MTR-NO: 392287; MTR-CODE: OM 356.955; OE-NO.: 0039970792; MOD: U 1550L	AVX 13 x 1250 TM
				FAN	FROM MTR-NO: 392288; MTR-CODE: OM 356.955; OE-NO.: 0049971292; MOD: U 1550L	AVX 13 x 1275
				FAN	FROM MTR-NO: 392288; MTR-CODE: OM 356.955; OE-NO.: 0049971292; MOD: U 1550L	AVX 13 x 1275 TM
				FAN	MTR-CODE: OM 356.955; OE-NO.: 0049976192; MOD: U 1550L	AVX 13 x 1625
				FAN	MTR-CODE: OM 356.955; OE-NO.: 0049976192; MOD: U 1550L	AVX 13 x 1625 TM
				PS	MTR-CODE: OM 356.955; OE-NO.: 0119973192; MOD: U 1550L	AVX 13 x 975
				PS	MTR-CODE: OM 356.955; OE-NO.: 0119973192; MOD: U 1550L	AVX 13 x 975 TM
				S-PUL	MTR-CODE: OM 356.955; OE-NO.: 0049976992; MOD: U 1550L	AVX 13 x 1125
				S-PUL	MTR-CODE: OM 356.955; OE-NO.: 0049976992; MOD: U 1550L	AVX 13 x 1125 TM

#### 1550L

5958 ccm	150 kW	OM 356.997;OM 357.924;OM 366.984	05.88 -	AC-C	MTR-CODE: OM 356.955; OE-NO.: 0049976992; MOD: U 1550L	AVX 13 x 1125
				AC-C	MTR-CODE: OM 356.955; OE-NO.: 0049976992; MOD: U 1550L	AVX 13 x 1125 TM
				AC-C	UNTIL MTR-NO: 392287; MTR-CODE: OM 356.955; OE-NO.: 0039970792; MOD: U 1550L	AVX 13 x 1250
				AC-C	UNTIL MTR-NO: 392287; MTR-CODE: OM 356.955; OE-NO.: 0039970792; MOD: U 1550L	AVX 13 x 1250 TM
				AIR-C	MTR-CODE: OM 356.955; OE-NO.: 0119973192; MOD: U 1550L	AVX 13 x 975
				AIR-C	MTR-CODE: OM 356.955; OE-NO.: 0119973192; MOD: U 1550L	AVX 13 x 975 TM
				ALT	MTR-CODE: OM 356.955; OE-NO.: 0049976192; MOD: U 1550L	AVX 13 x 1625
				ALT	MTR-CODE: OM 356.955; OE-NO.: 0049976192; MOD: U 1550L	AVX 13 x 1625 TM
				FAN	FROM MTR-NO: 392288; MTR-CODE: OM 356.955; OE-NO.: 0049971292; MOD: U 1550L	AVX 13 x 1275
				FAN	FROM MTR-NO: 392288; MTR-CODE: OM 356.955; OE-NO.: 0049971292; MOD: U 1550L	AVX 13 x 1275 TM

#### 1550L

5958 ccm	177 kW	OM 356.980;OM 357.945	05.88 -	AC-C	MTR-CODE: OM 356.955; OE-NO.: 0049976992; MOD: U 1550L	AVX 13 x 1125
				AC-C	MTR-CODE: OM 356.955; OE-NO.: 0049976992; MOD: U 1550L	AVX 13 x 1125 TM
				AC-C	UNTIL MTR-NO: 392287; MTR-CODE: OM 356.955; OE-NO.: 0039970792; MOD: U 1550L	AVX 13 x 1250
				AC-C	UNTIL MTR-NO: 392287; MTR-CODE: OM 356.955; OE-NO.: 0039970792; MOD: U 1550L	AVX 13 x 1250 TM
				AIR-C	MTR-CODE: OM 356.955; OE-NO.: 0119973192; MOD: U 1550L	AVX 13 x 975
				AIR-C	MTR-CODE: OM 356.955; OE-NO.: 0119973192; MOD: U 1550L	AVX 13 x 975 TM
				ALT	MTR-CODE: OM 356.955; OE-NO.: 0049976192; MOD: U 1550L	AVX 13 x 1625



## MERCEDES-BENZ

### UNIMOG

#### 1550L

5958 ccm	177 kW	OM 356.980;OM 357.945	05.88 -	ALT	MTR-CODE: OM 356.955; OE-NO.: 0049976192; MOD: U 1550L	AVX 13 x 1625 TM
				FAN	FROM MTR-NO: 392288; MTR-CODE: OM 356.955; OE-NO.: 0049971292; MOD: U 1550L	AVX 13 x 1275
				FAN	FROM MTR-NO: 392288; MTR-CODE: OM 356.955; OE-NO.: 0049971292; MOD: U 1550L	AVX 13 x 1275 TM

#### 1600

5958 ccm	115 kW	OM 356.956;OM 366.949	01.88 -	AC-C	MTR-CODE: OM 356.956; OE-NO.: 0049976992; MOD: U 1600	AVX 13 x 1125
				AC-C	MTR-CODE: OM 356.956; OE-NO.: 0049976992; MOD: U 1600	AVX 13 x 1125 TM
				AC-C	UNTIL MTR-NO: 392287; MTR-CODE: OM 356.956; OE-NO.: 0039970792; MOD: U 1600	AVX 13 x 1250
				AC-C	UNTIL MTR-NO: 392287; MTR-CODE: OM 356.956; OE-NO.: 0039970792; MOD: U 1600	AVX 13 x 1250 TM
				AIR-C	MTR-CODE: OM 356.956; OE-NO.: 0119973192; MOD: U 1600	AVX 13 x 975
				AIR-C	MTR-CODE: OM 356.956; OE-NO.: 0119973192; MOD: U 1600	AVX 13 x 975 TM
				ALT	MTR-CODE: OM 356.956; OE-NO.: 0049976192; MOD: U 1600	AVX 13 x 1625
				ALT	MTR-CODE: OM 356.956; OE-NO.: 0049976192; MOD: U 1600	AVX 13 x 1625 TM
				FAN	FROM MTR-NO: 392288; MTR-CODE: OM 356.956; OE-NO.: 0049971292; MOD: U 1600	AVX 13 x 1275
				FAN	FROM MTR-NO: 392288; MTR-CODE: OM 356.956; OE-NO.: 0049971292; MOD: U 1600	AVX 13 x 1275 TM

#### 1600

5958 ccm	150 kW	OM 356.997;OM 357.924;OM 366.984	09.89 -	AC-C	UNTIL MTR-NO: 392287; MTR-CODE: OM 356.956; OE-NO.: 0039970792; MOD: U 1600	AVX 13 x 1250
				AC-C	UNTIL MTR-NO: 392287; MTR-CODE: OM 356.956; OE-NO.: 0039970792; MOD: U 1600	AVX 13 x 1250 TM
				ALT	FROM MTR-NO: 392288; MTR-CODE: OM 356.956; OE-NO.: 0049971292; MOD: U 1600	AVX 13 x 1275
				ALT	FROM MTR-NO: 392288; MTR-CODE: OM 356.956; OE-NO.: 0049971292; MOD: U 1600	AVX 13 x 1275 TM
				FAN	MTR-CODE: OM 356.956; OE-NO.: 0049976192; MOD: U 1600	AVX 13 x 1625
				FAN	MTR-CODE: OM 356.956; OE-NO.: 0049976192; MOD: U 1600	AVX 13 x 1625 TM
				PS	MTR-CODE: OM 356.956; OE-NO.: 0119973192; MOD: U 1600	AVX 13 x 975
				PS	MTR-CODE: OM 356.956; OE-NO.: 0119973192; MOD: U 1600	AVX 13 x 975 TM
				S-PUL	MTR-CODE: OM 356.956; OE-NO.: 0049976992; MOD: U 1600	AVX 13 x 1125
				S-PUL	MTR-CODE: OM 356.956; OE-NO.: 0049976992; MOD: U 1600	AVX 13 x 1125 TM

#### 1600

5958 ccm	177 kW	OM 356.980;OM 357.945	05.91 -	AC-C	MTR-CODE: OM 356.956; OE-NO.: 0049976992; MOD: U 1600	AVX 13 x 1125
				AC-C	MTR-CODE: OM 356.956; OE-NO.: 0049976992; MOD: U 1600	AVX 13 x 1125 TM
				AC-C	UNTIL MTR-NO: 392287; MTR-CODE: OM 356.956; OE-NO.: 0039970792; MOD: U 1600	AVX 13 x 1250
				AC-C	UNTIL MTR-NO: 392287; MTR-CODE: OM 356.956; OE-NO.: 0039970792; MOD: U 1600	AVX 13 x 1250 TM
				AIR-C	MTR-CODE: OM 356.956; OE-NO.: 0119973192; MOD: U 1600	AVX 13 x 975
				AIR-C	MTR-CODE: OM 356.956; OE-NO.: 0119973192; MOD: U 1600	AVX 13 x 975 TM
				ALT	MTR-CODE: OM 356.956; OE-NO.: 0049976192; MOD: U 1600	AVX 13 x 1625
				ALT	MTR-CODE: OM 356.956; OE-NO.: 0049976192; MOD: U 1600	AVX 13 x 1625 TM
				FAN	FROM MTR-NO: 392288; MTR-CODE: OM 356.956; OE-NO.: 0049971292; MOD: U 1600	AVX 13 x 1275
				FAN	FROM MTR-NO: 392288; MTR-CODE: OM 356.956; OE-NO.: 0049971292; MOD: U 1600	AVX 13 x 1275 TM

#### 1650; 1650L

5958 ccm	115 kW	OM 356.956;OM 366.948;OM 366.949	01.88 -	AC-C	MTR-CODE: OM 356.956; OE-NO.: 0049976992; MOD: U 1650;U 1650L	AVX 13 x 1125
----------	--------	----------------------------------	---------	------	---	---------------



## MERCEDES-BENZ

### UNIMOG

#### 1650; 1650L

5958 ccm	115 kW	OM 356.956;OM 366.948;OM 366.949	01.88 -	AC-C	MTR-CODE: OM 356.956; OE-NO.: 0049976992; MOD: U 1650;U 1650L	AVX 13 x 1125 TM
				AC-C	UNTIL MTR-NO: 392287; MTR-CODE: OM 356.956; OE-NO.: 0039970792; MOD: U 1650;U 1650L	AVX 13 x 1250
				AC-C	UNTIL MTR-NO: 392287; MTR-CODE: OM 356.956; OE-NO.: 0039970792; MOD: U 1650;U 1650L	AVX 13 x 1250 TM
				AIR-C	MTR-CODE: OM 356.956; OE-NO.: 0119973192; MOD: U 1650;U 1650L	AVX 13 x 975
				AIR-C	MTR-CODE: OM 356.956; OE-NO.: 0119973192; MOD: U 1650;U 1650L	AVX 13 x 975 TM
				ALT	MTR-CODE: OM 356.956; OE-NO.: 0049976192; MOD: U 1650;U 1650L	AVX 13 x 1625
				ALT	MTR-CODE: OM 356.956; OE-NO.: 0049976192; MOD: U 1650;U 1650L	AVX 13 x 1625 TM
				FAN	FROM MTR-NO: 392288; MTR-CODE: OM 356.956; OE-NO.: 0049971292; MOD: U 1650;U 1650L	AVX 13 x 1275
				FAN	FROM MTR-NO: 392288; MTR-CODE: OM 356.956; OE-NO.: 0049971292; MOD: U 1650;U 1650L	AVX 13 x 1275 TM

#### 1650; 1650L

5958 ccm	150 kW	OM 356.997;OM 357.924;OM 366.984	09.89 -	AC-C	UNTIL MTR-NO: 392287; MTR-CODE: OM 356.956; OE-NO.: 0039970792; MOD: U 1650;U 1650L	AVX 13 x 1250
				AC-C	UNTIL MTR-NO: 392287; MTR-CODE: OM 356.956; OE-NO.: 0039970792; MOD: U 1650;U 1650L	AVX 13 x 1250 TM
				ALT	FROM MTR-NO: 392288; MTR-CODE: OM 356.956; OE-NO.: 0049971292; MOD: U 1650;U 1650L	AVX 13 x 1275
				ALT	FROM MTR-NO: 392288; MTR-CODE: OM 356.956; OE-NO.: 0049971292; MOD: U 1650;U 1650L	AVX 13 x 1275 TM
				FAN	MTR-CODE: OM 356.956; OE-NO.: 0049976192; MOD: U 1650;U 1650L	AVX 13 x 1625
				FAN	MTR-CODE: OM 356.956; OE-NO.: 0049976192; MOD: U 1650;U 1650L	AVX 13 x 1625 TM
				PS	MTR-CODE: OM 356.956; OE-NO.: 0119973192; MOD: U 1650;U 1650L	AVX 13 x 975
				PS	MTR-CODE: OM 356.956; OE-NO.: 0119973192; MOD: U 1650;U 1650L	AVX 13 x 975 TM
				S-PUL	MTR-CODE: OM 356.956; OE-NO.: 0049976992; MOD: U 1650;U 1650L	AVX 13 x 1125
				S-PUL	MTR-CODE: OM 356.956; OE-NO.: 0049976992; MOD: U 1650;U 1650L	AVX 13 x 1125 TM

#### 1650; 1650L

5958 ccm	177 kW	OM 356.980;OM 357.945	05.91 -	AC-C	MTR-CODE: OM 356.956; OE-NO.: 0049976992; MOD: U 1650;U 1650L	AVX 13 x 1125
				AC-C	MTR-CODE: OM 356.956; OE-NO.: 0049976992; MOD: U 1650;U 1650L	AVX 13 x 1125 TM
				AC-C	UNTIL MTR-NO: 392287; MTR-CODE: OM 356.956; OE-NO.: 0039970792; MOD: U 1650;U 1650L	AVX 13 x 1250
				AC-C	UNTIL MTR-NO: 392287; MTR-CODE: OM 356.956; OE-NO.: 0039970792; MOD: U 1650;U 1650L	AVX 13 x 1250 TM
				AIR-C	MTR-CODE: OM 356.956; OE-NO.: 0119973192; MOD: U 1650;U 1650L	AVX 13 x 975
				AIR-C	MTR-CODE: OM 356.956; OE-NO.: 0119973192; MOD: U 1650;U 1650L	AVX 13 x 975 TM
				ALT	MTR-CODE: OM 356.956; OE-NO.: 0049976192; MOD: U 1650;U 1650L	AVX 13 x 1625
				ALT	MTR-CODE: OM 356.956; OE-NO.: 0049976192; MOD: U 1650;U 1650L	AVX 13 x 1625 TM
				FAN	FROM MTR-NO: 392288; MTR-CODE: OM 356.956; OE-NO.: 0049971292; MOD: U 1650;U 1650L	AVX 13 x 1275
				FAN	FROM MTR-NO: 392288; MTR-CODE: OM 356.956; OE-NO.: 0049971292; MOD: U 1650;U 1650L	AVX 13 x 1275 TM

#### 1700

5958 ccm	122 kW	OM 356.957;OM 366.963;OM 382.950	09.88 -	AC-C	MTR-CODE: OM 356.957; OE-NO.: 0049976992; MOD: U 1700;U 1700T	AVX 13 x 1125
----------	--------	----------------------------------	---------	------	---	---------------



## MERCEDES-BENZ

### UNIMOG

#### 1700

5958 ccm	122 kW	OM 356.957;OM 366.963;OM 382.950	09.88 -	AC-C	MTR-CODE: OM 356.957; OE-NO.: 0049976992; MOD: U 1700;U 1700T	AVX 13 x 1125 TM
				AC-C	UNTIL MTR-NO: 392287; MTR-CODE: OM 356.957; OE-NO.: 0039970792; MOD: U 1700;U 1700T	AVX 13 x 1250
				AC-C	UNTIL MTR-NO: 392287; MTR-CODE: OM 356.957; OE-NO.: 0039970792; MOD: U 1700;U 1700T	AVX 13 x 1250 TM
				AIR-C	MTR-CODE: OM 356.957; OE-NO.: 0119973192; MOD: U 1700;U 1700T	AVX 13 x 975
				AIR-C	MTR-CODE: OM 356.957; OE-NO.: 0119973192; MOD: U 1700;U 1700T	AVX 13 x 975 TM
				ALT	MTR-CODE: OM 356.957; OE-NO.: 0049976192; MOD: U 1700;U 1700T	AVX 13 x 1625
				ALT	MTR-CODE: OM 356.957; OE-NO.: 0049976192; MOD: U 1700;U 1700T	AVX 13 x 1625 TM
				FAN	FROM MTR-NO: 392288; MTR-CODE: OM 356.957; OE-NO.: 0049971292; MOD: U 1700;U 1700T	AVX 13 x 1275
				FAN	FROM MTR-NO: 392288; MTR-CODE: OM 356.957; OE-NO.: 0049971292; MOD: U 1700;U 1700T	AVX 13 x 1275 TM

#### 1700T

5958 ccm	122 kW	OM 356.957;OM 366.963	09.88 -	AC-C	MTR-CODE: OM 356.957; OE-NO.: 0049976992; MOD: U 1700;U 1700T	AVX 13 x 1125
				AC-C	MTR-CODE: OM 356.957; OE-NO.: 0049976992; MOD: U 1700;U 1700T	AVX 13 x 1125 TM
				AC-C	UNTIL MTR-NO: 392287; MTR-CODE: OM 356.957; OE-NO.: 0039970792; MOD: U 1700;U 1700T	AVX 13 x 1250
				AC-C	UNTIL MTR-NO: 392287; MTR-CODE: OM 356.957; OE-NO.: 0039970792; MOD: U 1700;U 1700T	AVX 13 x 1250 TM
				AIR-C	MTR-CODE: OM 356.957; OE-NO.: 0119973192; MOD: U 1700;U 1700T	AVX 13 x 975
				AIR-C	MTR-CODE: OM 356.957; OE-NO.: 0119973192; MOD: U 1700;U 1700T	AVX 13 x 975 TM
				ALT	MTR-CODE: OM 356.957; OE-NO.: 0049976192; MOD: U 1700;U 1700T	AVX 13 x 1625
				ALT	MTR-CODE: OM 356.957; OE-NO.: 0049976192; MOD: U 1700;U 1700T	AVX 13 x 1625 TM
				FAN	FROM MTR-NO: 392288; MTR-CODE: OM 356.957; OE-NO.: 0049971292; MOD: U 1700;U 1700T	AVX 13 x 1275
				FAN	FROM MTR-NO: 392288; MTR-CODE: OM 356.957; OE-NO.: 0049971292; MOD: U 1700;U 1700T	AVX 13 x 1275 TM

#### 1750; 1750L

5958 ccm	122 kW	OM 356.957;OM 356.981;OM 366.963	09.88 -	AC-C	MTR-CODE: OM 356.957; OE-NO.: 0049976992; MOD: U 1750;U 1750L	AVX 13 x 1125
				AC-C	MTR-CODE: OM 356.957; OE-NO.: 0049976992; MOD: U 1750;U 1750L	AVX 13 x 1125 TM
				AC-C	UNTIL MTR-NO: 392287; MTR-CODE: OM 356.957; OE-NO.: 0039970792; MOD: U 1750;U 1750L	AVX 13 x 1250
				AC-C	UNTIL MTR-NO: 392287; MTR-CODE: OM 356.957; OE-NO.: 0039970792; MOD: U 1750;U 1750L	AVX 13 x 1250 TM
				AIR-C	MTR-CODE: OM 356.957; OE-NO.: 0119973192; MOD: U 1750;U 1750L	AVX 13 x 975
				AIR-C	MTR-CODE: OM 356.957; OE-NO.: 0119973192; MOD: U 1750;U 1750L	AVX 13 x 975 TM
				ALT	MTR-CODE: OM 356.957; OE-NO.: 0049976192; MOD: U 1750;U 1750L	AVX 13 x 1625
				ALT	MTR-CODE: OM 356.957; OE-NO.: 0049976192; MOD: U 1750;U 1750L	AVX 13 x 1625 TM
				FAN	FROM MTR-NO: 392288; MTR-CODE: OM 356.957; OE-NO.: 0049971292; MOD: U 1750;U 1750L	AVX 13 x 1275
				FAN	FROM MTR-NO: 392288; MTR-CODE: OM 356.957; OE-NO.: 0049971292; MOD: U 1750;U 1750L	AVX 13 x 1275 TM

#### 1750; 1750L

5958 ccm	122 kW	OM 356.957;OM 356.981;OM 366.963	09.88 -	AC-C	MTR-CODE: OM 356.957; OE-NO.: 0049976992; MOD: U 1750;U 1750L	AVX 13 x 1125
----------	--------	----------------------------------	---------	------	---	---------------

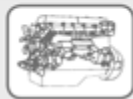

## MERCEDES-BENZ

### UNIMOG

#### 1750; 1750L

5958 ccm	122 kW	OM 356.957;OM 356.981;OM 366.963	09.88 -	AC-C	MTR-CODE: OM 356.957; OE-NO.: 0049976992; MOD: U 1750;U 1750L	AVX 13 x 1125 TM
				AC-C	UNTIL MTR-NO: 392287; MTR-CODE: OM 356.957; OE-NO.: 0039970792; MOD: U 1750;U 1750L	AVX 13 x 1250
				AC-C	UNTIL MTR-NO: 392287; MTR-CODE: OM 356.957; OE-NO.: 0039970792; MOD: U 1750;U 1750L	AVX 13 x 1250 TM
				AIR-C	MTR-CODE: OM 356.957; OE-NO.: 0119973192; MOD: U 1750;U 1750L	AVX 13 x 975
				AIR-C	MTR-CODE: OM 356.957; OE-NO.: 0119973192; MOD: U 1750;U 1750L	AVX 13 x 975 TM
				ALT	MTR-CODE: OM 356.957; OE-NO.: 0049976192; MOD: U 1750;U 1750L	AVX 13 x 1625
				ALT	MTR-CODE: OM 356.957; OE-NO.: 0049976192; MOD: U 1750;U 1750L	AVX 13 x 1625 TM
				FAN	FROM MTR-NO: 392288; MTR-CODE: OM 356.957; OE-NO.: 0049971292; MOD: U 1750;U 1750L	AVX 13 x 1275
				FAN	FROM MTR-NO: 392288; MTR-CODE: OM 356.957; OE-NO.: 0049971292; MOD: U 1750;U 1750L	AVX 13 x 1275 TM

#### 2100

5958 ccm	155 kW	OM 356.997;OM 366.984	09.89 -	AC-C	MTR-CODE: OM 356.997; OE-NO.: 0049976992; MOD: U 2100;U 2100T	AVX 13 x 1125
				AC-C	MTR-CODE: OM 356.997; OE-NO.: 0049976992; MOD: U 2100;U 2100T	AVX 13 x 1125 TM
				AC-C	UNTIL MTR-NO: 392287; MTR-CODE: OM 356.997; OE-NO.: 0039970792; MOD: U 2100;U 2100T	AVX 13 x 1250
				AC-C	UNTIL MTR-NO: 392287; MTR-CODE: OM 356.997; OE-NO.: 0039970792; MOD: U 2100;U 2100T	AVX 13 x 1250 TM
				AIR-C	MTR-CODE: OM 356.997; OE-NO.: 0119973192; MOD: U 2100;U 2100T	AVX 13 x 975
				AIR-C	MTR-CODE: OM 356.997; OE-NO.: 0119973192; MOD: U 2100;U 2100T	AVX 13 x 975 TM
				ALT	MTR-CODE: OM 356.997; OE-NO.: 0049976192; MOD: U 2100;U 2100T	AVX 13 x 1625
				ALT	MTR-CODE: OM 356.997; OE-NO.: 0049976192; MOD: U 2100;U 2100T	AVX 13 x 1625 TM
				FAN	FROM MTR-NO: 392288; MTR-CODE: OM 356.997; OE-NO.: 0049971292; MOD: U 2100;U 2100T	AVX 13 x 1275
				FAN	FROM MTR-NO: 392288; MTR-CODE: OM 356.997; OE-NO.: 0049971292; MOD: U 2100;U 2100T	AVX 13 x 1275 TM

#### 2100T

5958 ccm	155 kW	OM 356.997;OM 366.984	09.89 -	AC-C	MTR-CODE: OM 356.997; OE-NO.: 0049976992; MOD: U 2100;U 2100T	AVX 13 x 1125
				AC-C	MTR-CODE: OM 356.997; OE-NO.: 0049976992; MOD: U 2100;U 2100T	AVX 13 x 1125 TM
				AC-C	UNTIL MTR-NO: 392287; MTR-CODE: OM 356.997; OE-NO.: 0039970792; MOD: U 2100;U 2100T	AVX 13 x 1250
				AC-C	UNTIL MTR-NO: 392287; MTR-CODE: OM 356.997; OE-NO.: 0039970792; MOD: U 2100;U 2100T	AVX 13 x 1250 TM
				AIR-C	MTR-CODE: OM 356.997; OE-NO.: 0119973192; MOD: U 2100;U 2100T	AVX 13 x 975
				AIR-C	MTR-CODE: OM 356.997; OE-NO.: 0119973192; MOD: U 2100;U 2100T	AVX 13 x 975 TM
				ALT	MTR-CODE: OM 356.997; OE-NO.: 0049976192; MOD: U 2100;U 2100T	AVX 13 x 1625
				ALT	MTR-CODE: OM 356.997; OE-NO.: 0049976192; MOD: U 2100;U 2100T	AVX 13 x 1625 TM
				FAN	FROM MTR-NO: 392288; MTR-CODE: OM 356.997; OE-NO.: 0049971292; MOD: U 2100;U 2100T	AVX 13 x 1275
				FAN	FROM MTR-NO: 392288; MTR-CODE: OM 356.997; OE-NO.: 0049971292; MOD: U 2100;U 2100T	AVX 13 x 1275 TM

#### 2150

5958 ccm	155 kW	OM 356.997;OM 366.984	09.89 -	AC-C	MTR-CODE: OM 356.980;OM 366; OE-NO.: 0049976992; MOD: U 2150	AVX 13 x 1125
----------	--------	-----------------------	---------	------	--	---------------



## MERCEDES-BENZ

### UNIMOG

#### 2150

5958 ccm	155 kW	OM 356.997;OM 366.984	09.89 -	AC-C	MTR-CODE: OM 356.980;OM 366; OE-NO.: 0049976992; MOD: U 2150	<b>AVX 13 x 1125 TM</b>
				AC-C	UNTIL MTR-NO: 392287; MTR-CODE: OM 356.980;OM 366; OE-NO.: 0039970792; MOD: U 2150	<b>AVX 13 x 1250</b>
				AC-C	UNTIL MTR-NO: 392287; MTR-CODE: OM 356.980;OM 366; OE-NO.: 0039970792; MOD: U 2150	<b>AVX 13 x 1250 TM</b>
				AIR-C	MTR-CODE: OM 356.980;OM 366; OE-NO.: 0119973192; MOD: U 2150	<b>AVX 13 x 975</b>
				AIR-C	MTR-CODE: OM 356.980;OM 366; OE-NO.: 0119973192; MOD: U 2150	<b>AVX 13 x 975 TM</b>
				ALT	MTR-CODE: OM 356.980;OM 366; OE-NO.: 0049976192; MOD: U 2150	<b>AVX 13 x 1625</b>
				ALT	MTR-CODE: OM 356.980;OM 366; OE-NO.: 0049976192; MOD: U 2150	<b>AVX 13 x 1625 TM</b>
				FAN	FROM MTR-NO: 392288; MTR-CODE: OM 356.980;OM 366; OE-NO.: 0049971292; MOD: U 2150	<b>AVX 13 x 1275</b>
				FAN	FROM MTR-NO: 392288; MTR-CODE: OM 356.980;OM 366; OE-NO.: 0049971292; MOD: U 2150	<b>AVX 13 x 1275 TM</b>

#### 2150; 2150L

5958 ccm	155 kW	OM 356.997;OM 357.924;OM 366.984	09.89 -	AC-C	MTR-CODE: OM 356.980;OM 366; OE-NO.: 0049976992; MOD: U 2150	<b>AVX 13 x 1125</b>
				AC-C	MTR-CODE: OM 356.980;OM 366; OE-NO.: 0049976992; MOD: U 2150	<b>AVX 13 x 1125 TM</b>
				AC-C	UNTIL MTR-NO: 392287; MTR-CODE: OM 356.980;OM 366; OE-NO.: 0039970792; MOD: U 2150	<b>AVX 13 x 1250</b>
				AC-C	UNTIL MTR-NO: 392287; MTR-CODE: OM 356.980;OM 366; OE-NO.: 0039970792; MOD: U 2150	<b>AVX 13 x 1250 TM</b>
				AIR-C	MTR-CODE: OM 356.980;OM 366; OE-NO.: 0119973192; MOD: U 2150	<b>AVX 13 x 975</b>
				AIR-C	MTR-CODE: OM 356.980;OM 366; OE-NO.: 0119973192; MOD: U 2150	<b>AVX 13 x 975 TM</b>
				ALT	MTR-CODE: OM 356.980;OM 366; OE-NO.: 0049976192; MOD: U 2150	<b>AVX 13 x 1625</b>
				ALT	MTR-CODE: OM 356.980;OM 366; OE-NO.: 0049976192; MOD: U 2150	<b>AVX 13 x 1625 TM</b>
				FAN	FROM MTR-NO: 392288; MTR-CODE: OM 356.980;OM 366; OE-NO.: 0049971292; MOD: U 2150	<b>AVX 13 x 1275</b>
				FAN	FROM MTR-NO: 392288; MTR-CODE: OM 356.980;OM 366; OE-NO.: 0049971292; MOD: U 2150	<b>AVX 13 x 1275 TM</b>

#### 2150; 2150L

5958 ccm	177 kW	OM 356.980;OM 357.945	09.89 -	AC-C	MTR-CODE: OM 356.980;OM 366; OE-NO.: 0049976992; MOD: U 2150	<b>AVX 13 x 1125</b>
				AC-C	MTR-CODE: OM 356.980;OM 366; OE-NO.: 0049976992; MOD: U 2150	<b>AVX 13 x 1125 TM</b>
				AC-C	UNTIL MTR-NO: 392287; MTR-CODE: OM 356.980;OM 366; OE-NO.: 0039970792; MOD: U 2150	<b>AVX 13 x 1250</b>
				AC-C	UNTIL MTR-NO: 392287; MTR-CODE: OM 356.980;OM 366; OE-NO.: 0039970792; MOD: U 2150	<b>AVX 13 x 1250 TM</b>
				AIR-C	MTR-CODE: OM 356.980;OM 366; OE-NO.: 0119973192; MOD: U 2150	<b>AVX 13 x 975</b>
				AIR-C	MTR-CODE: OM 356.980;OM 366; OE-NO.: 0119973192; MOD: U 2150	<b>AVX 13 x 975 TM</b>
				ALT	MTR-CODE: OM 356.980;OM 366; OE-NO.: 0049976192; MOD: U 2150	<b>AVX 13 x 1625</b>
				ALT	MTR-CODE: OM 356.980;OM 366; OE-NO.: 0049976192; MOD: U 2150	<b>AVX 13 x 1625 TM</b>
				FAN	FROM MTR-NO: 392288; MTR-CODE: OM 356.980;OM 366; OE-NO.: 0049971292; MOD: U 2150	<b>AVX 13 x 1275</b>
				FAN	FROM MTR-NO: 392288; MTR-CODE: OM 356.980;OM 366; OE-NO.: 0049971292; MOD: U 2150	<b>AVX 13 x 1275 TM</b>



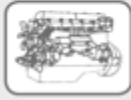

## MERCEDES-BENZ

### 100 Bus (631)

<b>D</b>						
2399 ccm	41 kW	OM 616	12.90 - 12.94	ALT		AVX 13 x 1015 TM
				PS	OE-NO.: 0089972392	AVX 13 x 650
				PS	OE-NO.: 0089976692	AVX 13 x 700

### 100 Kasten (631)

<b>D (631.332, 631.342)</b>						
2399 ccm	53 kW	OM 616.963	02.88 - 05.92	ALT		AVX 13 x 1015 TM
				PS		AVX 13 x 700

<b>D (631.332, 631.342)</b>						
2399 ccm	55 kW	OM 616.963	12.90 - 02.96	PS		AVX 13 x 700

### VIANO (W639)

<b>3,0</b>						
3199 ccm	140 kW	M 112.951	09.03 -	ALT	- AC	6 PK 2315
				ALT	+ AC	6 PK 2373

<b>3.2</b>						
3199 ccm	160 kW	M 112.951	09.03 -	ALT	- AC	6 PK 2315
				ALT	+ AC	6 PK 2373

<b>3.5</b>						
3498 ccm	190 kW	M 272.979	09.07 -	ALT		6 PK 2404

<b>3.7</b>						
3724 ccm	170 kW	M 112.976	06.04 -	ALT		6 PK 2373

<b>CDI 2.0</b>						
2148 ccm	80 kW	OM 646.982	09.03 -	ALT		6 PK 2260
				ALT	FROM: 04.05; FROM CHA-NO.: 158570; 2. ALT;	6 PK 2285
				ALT	2 ALT; + PTO	
				ALT	UNTIL: 04.05; UNTIL CHA-NO.: 158569; 2. ALT;	6 PK 2270
					2 ALT; + PTO	

<b>CDI 2.0 4-matic</b>						
2148 ccm	80 kW	OM 646.982	07.05 -	ALT		6 PK 2260
				ALT	FROM CHA-NO.: 158570; 2. ALT; 2 ALT; + PTO	6 PK 2285

<b>CDI 2.0</b>						
2148 ccm	85 kW	OM 646.982	08.05 -	ALT		6 PK 2260
				ALT	2. ALT; 2 ALT; + PTO	6 PK 2285

<b>CDI 2.2</b>						
2148 ccm	110 kW	OM 646.982	09.03 -	ALT		6 PK 2260
				ALT	FROM: 04.05; FROM CHA-NO.: 158570; 2. ALT;	6 PK 2285
					2 ALT; + PTO	
				ALT	UNTIL: 04.05; UNTIL CHA-NO.: 158569; 2. ALT;	6 PK 2270
					2 ALT; + PTO	

<b>CDI 2.2 4-matic</b>						
2148 ccm	110 kW	OM 646.982	07.05 -	ALT	FROM: 03.06	6 PK 2260
				ALT	FROM: 03.06; 2. ALT; 2 ALT; + PTO	6 PK 2285

<b>CDI 3.0</b>						
2987 ccm	150 kW	OM 642.990	03.06 -	ALT		7 PK 2035
				FAN		6 EPK 691

### VITO Bus (638)

<b>113 2.0 (638.114, 638.194)</b>						
1998 ccm	95 kW	M 111.948;M 111.950	02.96 - 07.03	ALT	- AC	6 PK 2100
				ALT	+ AC	6 PK 2205

<b>114 2.3 (638.134, 638.194)</b>						
2295 ccm	105 kW	M 111.978	12.96 - 07.03	ALT	- AC	6 PK 2100
				ALT	+ AC	6 PK 2205

<b>108 CDI 2.2 (638.194)</b>						
2148 ccm	60 kW	OM 611A (60 KW CDI)	03.99 - 07.03	ALT	- AC	6 PK 2075
				ALT	+ AC	6 PK 2160

<b>110 CDI 2.2 (638.194)</b>						
2148 ccm	75 kW	OM 611LA (75 KW CDI)	03.99 - 07.03	ALT	- AC	6 PK 2075
				ALT	+ AC	6 PK 2160

<b>112 CDI 2.2 (638.194)</b>						
2151 ccm	90 kW	OM 611.980	03.99 - 07.03	ALT	- AC	6 PK 2075
				ALT	+ AC	6 PK 2160

<b>108 D 2.3 (638.164)</b>						
2299 ccm	58 kW	OM 601.942	02.96 - 07.03	ALT	- AC	6 PK 2000
				ALT	+ AC	6 PK 2080



## MERCEDES-BENZ

### VITO Bus (638)

#### 110 TD 2.3 (638.174)

2299 ccm	72 kW	OM 601.970	02.96 - 07.03	ALT	- AC	6 PK 2020
				ALT	+ AC	6 PK 2100

### VITO Kasten (638)

#### 113 2.0 (638.014, 638.094)

1998 ccm	95 kW	M 111.948;M 111.950	03.97 - 07.03	ALT	- AC	6 PK 2100
				ALT	+ AC	6 PK 2205

#### 114 2.3 (638.034, 638.094)

2295 ccm	105 kW	M 111.978	03.97 - 07.03	ALT	- AC	6 PK 2100
				ALT	+ AC	6 PK 2205

#### 108 CDI 2.2 (638.094)

2151 ccm	60 kW	OM 611A (60 KW CDI)	03.99 - 07.03	ALT	- AC	6 PK 2075
				ALT	+ AC	6 PK 2160

#### 110 CDI 2.2 (638.094)

2151 ccm	75 kW	OM 611LA (75 KW CDI)	03.99 - 07.03	ALT	- AC	6 PK 2075
				ALT	+ AC	6 PK 2160

#### 112 CDI 2.2 (638.094)

2151 ccm	90 kW	OM 611.980	03.99 - 07.03	ALT	- AC	6 PK 2075
				ALT	+ AC	6 PK 2160

#### 108 D 2.3 (638.064)

2299 ccm	58 kW	OM 601.942	03.97 - 07.03	ALT	- AC	6 PK 2000
				ALT	+ AC	6 PK 2080

#### 110 D 2.3 (638.074)

2299 ccm	72 kW	OM 601.970	03.97 - 07.03	ALT	- AC	6 PK 2020
				ALT	+ AC	6 PK 2100

### VITO Bus (W639)

#### 119

3199 ccm	140 kW	M 112.951	09.03 -	ALT		6 PK 2373
----------	--------	-----------	---------	-----	--	-----------

#### 122

3199 ccm	160 kW	M 112.951	09.03 -	ALT		6 PK 2373
----------	--------	-----------	---------	-----	--	-----------

#### 126

3498 ccm	190 kW	M 272.978	09.07 -	ALT	FROM: 02.08	6 PK 2404
----------	--------	-----------	---------	-----	-------------	-----------

#### 123

3724 ccm	170 kW	M 112.976	06.04 -	ALT		6 PK 2373
----------	--------	-----------	---------	-----	--	-----------

#### 109 CDI

2148 ccm	65 kW	OM 646.983	09.03 -	ALT	- ENG-PTO	6 PK 2260
				ALT	FROM: 05.05; FROM CHA-NO.: 158570; + ENG-PTO	6 PK 2285
				ALT	UNTIL: 04.05; UNTIL CHA-NO.: 158569; + ENG-PTO	6 PK 2270

#### 109 CDI 4x4

2148 ccm	70 kW	OM 646.981	09.07 -	ALT	- ENG-PTO	6 PK 2260
				ALT	FROM CHA-NO.: 158570; + ENG-PTO	6 PK 2285

#### 109 CDI

2148 ccm	70 kW	OM 646.980	09.06 -	ALT	- ENG-PTO	6 PK 2260
				ALT	FROM CHA-NO.: 158570; + ENG-PTO	6 PK 2285

#### 111 CDI

2148 ccm	80 kW	OM 646.982	09.03 -	ALT	- ENG-PTO	6 PK 2260
				ALT	FROM: 05.05; FROM CHA-NO.: 158570; + ENG-PTO	6 PK 2285
				ALT	UNTIL: 04.05; UNTIL CHA-NO.: 158569; + ENG-PTO	6 PK 2270

#### 111 CDI 4x4

2148 ccm	80 kW	OM 646.982	09.07 -	ALT	- ENG-PTO	6 PK 2260
				ALT	+ ENG-PTO	6 PK 2285

#### 111 CDI

2148 ccm	85 kW	OM 646.982	09.07 -	ALT	- ENG-PTO	6 PK 2260
				ALT	+ ENG-PTO	6 PK 2285

#### 115 CDI

2148 ccm	110 kW	OM 646.982	09.03 -	ALT		6 PK 2260
----------	--------	------------	---------	-----	--	-----------

#### 115 CDI 4x4

2148 ccm	110 kW	OM 646.982	09.07 -	ALT		6 PK 2260
----------	--------	------------	---------	-----	--	-----------

#### 120 CDI

2987 ccm	150 kW	OM 642.990	09.07 -	ALT		7 PK 2035
----------	--------	------------	---------	-----	--	-----------

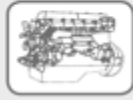

## MERCEDES-BENZ

### VITO / MIXTO Kasten (W639)

#### 119

3199 ccm 140 kW M 112.951 09.03 - ALT 6 PK 2373

#### 122

3199 ccm 160 kW M 112.951 09.03 - ALT 6 PK 2373

#### 126

3498 ccm 190 kW M 272.978 09.07 - ALT FROM: 02.08 6 PK 2404

#### 123 (639.603)

3724 ccm 170 kW M 112.976 06.04 - ALT 6 PK 2373

#### 109 CDI

2148 ccm 65 kW OM 646.983 09.03 - ALT - ENG-PTO 6 PK 2260

ALT FROM: 05.05; FROM CHA-NO.: 158570; + ENG-PTO 6 PK 2285

ALT UNTIL: 04.05; UNTIL CHA-NO.: 158569; + ENG-PTO 6 PK 2270

#### 109 CDi

2148 ccm 70 kW OM 646.981 08.06 - ALT - ENG-PTO 6 PK 2260

ALT FROM CHA-NO.: 158570; + ENG-PTO 6 PK 2285

#### 111 CDI

2148 ccm 80 kW OM 646.982 09.03 - ALT - ENG-PTO 6 PK 2260

ALT FROM: 05.05; FROM CHA-NO.: 158570; + ENG-PTO 6 PK 2285

ALT UNTIL: 04.05; UNTIL CHA-NO.: 158569; + ENG-PTO 6 PK 2270

#### 111 CDI 4x4

2148 ccm 80 kW OM 646.982 09.07 - ALT - ENG-PTO 6 PK 2260

ALT + ENG-PTO 6 PK 2285

#### 111 CDI

2148 ccm 85 kW OM 646.982 09.07 - ALT - ENG-PTO 6 PK 2260

ALT + ENG-PTO 6 PK 2285

#### 115 CDI

2148 ccm 110 kW OM 646.982 09.03 - ALT 6 PK 2260

#### 115 CDI 4x4

2148 ccm 110 kW OM 646.982 09.07 - ALT 6 PK 2260

#### 120 CDI

2987 ccm 150 kW OM 642.990 09.07 - AC-C 6 EPK 691

ALT 7 PK 2035

### SPRINTER 2-t Bus (901, 902)

#### 214 NGT

2295 ccm 92 kW M 111.984 04.00 - 05.06 ALT FROM MTR-NO: 000442; + AUTO-TM; - AC 6 PK 2115

ALT FROM MTR-NO: 000442; + AUTO-TM; + AC 6 PK 2215

ALT UNTIL MTR-NO: 000441; + AUTO-TM; - AC 6 PK 2100

ALT UNTIL MTR-NO: 000441; + AUTO-TM; + AC 6 PK 2205

#### 214

2295 ccm 105 kW M 111.979 02.95 - 05.06 ALT FROM MTR-NO: 000442; + AUTO-TM; - AC 6 PK 2115

ALT FROM MTR-NO: 000442; + AUTO-TM; + AC 6 PK 2215

ALT FROM MTR-NO: 002029; + MAN-TM; - AC 6 PK 2115

ALT FROM MTR-NO: 002029; + MAN-TM; + AC 6 PK 2215

ALT UNTIL MTR-NO: 000441; + AUTO-TM; - AC 6 PK 2100

ALT UNTIL MTR-NO: 000441; + AUTO-TM; + AC 6 PK 2205

ALT UNTIL MTR-NO: 002028; + MAN-TM; - AC 6 PK 2100

ALT UNTIL MTR-NO: 002028; + MAN-TM; + AC 6 PK 2205

#### 208 CDI

2148 ccm 60 kW OM 611.987 04.00 - 05.06 ALT + AC 6 PK 2270

ALT FROM CHA-NO.: 220798; - AC 6 PK 2260

ALT UNTIL CHA-NO.: 220797; - AC 6 PK 2191

#### 211 CDI

2148 ccm 80 kW OM 611.981 04.00 - 05.06 ALT + AC 6 PK 2270

ALT FROM CHA-NO.: R220798; - AC 6 PK 2260

ALT UNTIL CHA-NO.: R220797; - AC 6 PK 2191

#### 213 CDI

2148 ccm 95 kW OM 611.981 04.00 - 05.06 ALT + AC 6 PK 2270

ALT FROM CHA-NO.: R220798; - AC 6 PK 2260

ALT UNTIL CHA-NO.: R220797; - AC 6 PK 2191

#### 208 D

2299 ccm 58 kW OM 601.943 02.95 - 04.00 ALT - AC 6 PK 2020

ALT + AC 6 PK 2100



## MERCEDES-BENZ

### SPRINTER 2-t Bus (901, 902)

#### 216 CDI

2685 ccm	115 kW	OM 612.981	04.00 - 05.06	ALT	+ AC	6 PK 2270
				ALT	FROM CHA-NO.: R220798; - AC	6 PK 2260
				ALT	UNTIL CHA-NO.: R220797; - AC	6 PK 2191

#### 210 D

2874 ccm	75 kW	OM 602.980	03.97 - 04.00	ALT	- AC	6 PK 2080
				ALT	+ AC	6 PK 2140

#### 212 D

2874 ccm	90 kW	OM 602.980	02.95 - 04.00	ALT	- AC	6 PK 2080
				ALT	+ AC	6 PK 2140

### SPRINTER 2-t Kasten (901, 902)

#### 214 NGT

2295 ccm	92 kW	M 111.984	04.00 - 05.06	ALT	FROM MTR-NO: 000442; + AUTO-TM; - AC	6 PK 2115
				ALT	FROM MTR-NO: 000442; + AUTO-TM; + AC	6 PK 2215
				ALT	UNTIL MTR-NO: 000441; + AUTO-TM; - AC	6 PK 2100
				ALT	UNTIL MTR-NO: 000441; + AUTO-TM; + AC	6 PK 2205

#### 214

2295 ccm	105 kW	M 111.979;M 111.984	02.95 - 05.06	ALT	FROM MTR-NO: 000442; + AUTO-TM; - AC	6 PK 2115
				ALT	FROM MTR-NO: 000442; + AUTO-TM; + AC	6 PK 2215
				ALT	FROM MTR-NO: 002029; + MAN-TM; - AC	6 PK 2115
				ALT	FROM MTR-NO: 002029; + MAN-TM; + AC	6 PK 2215
				ALT	UNTIL MTR-NO: 000441; + AUTO-TM; - AC	6 PK 2100
				ALT	UNTIL MTR-NO: 000441; + AUTO-TM; + AC	6 PK 2205
				ALT	UNTIL MTR-NO: 002028; + MAN-TM; - AC	6 PK 2100
				ALT	UNTIL MTR-NO: 002028; + MAN-TM; + AC	6 PK 2205

#### 208 CDI

2148 ccm	60 kW	OM 611.987	04.00 - 05.06	ALT	+ AC	6 PK 2270
				ALT	FROM CHA-NO.: 220798; - AC	6 PK 2260
				ALT	UNTIL CHA-NO.: 220797; - AC	6 PK 2191

#### 211 CDI

2148 ccm	80 kW	OM 611.981	04.00 - 05.06	ALT	+ AC	6 PK 2270
				ALT	FROM CHA-NO.: R220798; - AC	6 PK 2260
				ALT	UNTIL CHA-NO.: R220797; - AC	6 PK 2191

#### 213 CDI

2148 ccm	95 kW	OM 611.981	04.00 - 05.06	ALT	+ AC	6 PK 2270
				ALT	FROM CHA-NO.: R220798; - AC	6 PK 2260
				ALT	UNTIL CHA-NO.: R220797; - AC	6 PK 2191

#### 208 D

2299 ccm	58 kW	OM 601.943	02.95 - 04.00	ALT	- AC	6 PK 2020
				ALT	+ AC	6 PK 2100

#### 208 D

2299 ccm	60 kW	OM 601.943	10.96 - 04.00	ALT	- AC	6 PK 2020
				ALT	+ AC	6 PK 2100

#### 216 CDI

2685 ccm	115 kW	OM 612.981	04.00 - 05.06	ALT	+ AC	6 PK 2270
				ALT	FROM CHA-NO.: R220798; - AC	6 PK 2260
				ALT	UNTIL CHA-NO.: R220797; - AC	6 PK 2191

#### 210 D

2874 ccm	75 kW	OM 602.980	01.97 - 04.00	ALT	- AC	6 PK 2080
				ALT	+ AC	6 PK 2140

#### 212 D

2874 ccm	90 kW	OM 602.980	02.95 - 04.00	ALT	- AC	6 PK 2080
				ALT	+ AC	6 PK 2140

### SPRINTER 2-t Pritsche/Fahrgestell (901, 902)

#### 214 NGT

2295 ccm	92 kW		04.00 - 05.06	ALT	FROM MTR-NO: 000442; MTR-CODE: 111984; + AUTO-TM; - AC	6 PK 2115
				ALT	FROM MTR-NO: 000442; MTR-CODE: 111984; + AUTO-TM; + AC	6 PK 2215
				ALT	UNTIL MTR-NO: 000441; MTR-CODE: 111984; + AUTO-TM; - AC	6 PK 2100
				ALT	UNTIL MTR-NO: 000441; MTR-CODE: 111984; + AUTO-TM; + AC	6 PK 2205

#### 214

2295 ccm	105 kW	M 111.979	02.95 - 05.06	ALT	FROM MTR-NO: 000442; MTR-CODE: 111979;111984; + AUTO-TM; - AC	6 PK 2115
----------	--------	-----------	---------------	-----	---	-----------



## MERCEDES-BENZ

### SPRINTER 2-t Pritsche/Fahrgestell (901, 902)

#### 214

2295 ccm	105 kW	M 111.979	02.95 - 05.06	ALT	FROM MTR-NO: 000442; MTR-CODE: 111979;111984; + AUTO-TM; + AC	6 PK 2215
				ALT	FROM MTR-NO: 002029; MTR-CODE: 111979;111984; + MAN-TM; - AC	6 PK 2115
				ALT	FROM MTR-NO: 002029; MTR-CODE: 111979;111984; + MAN-TM; + AC	6 PK 2215
				ALT	FROM: 04.00; FROM MTR-NO: 000442; MTR-CODE: 111984; + AUTO-TM; - AC	6 PK 2115
				ALT	FROM: 04.00; FROM MTR-NO: 000442; MTR-CODE: 111984; + AUTO-TM; + AC	6 PK 2215
				ALT	FROM: 04.00; FROM MTR-NO: 002029; MTR-CODE: 111984; + MAN-TM; - AC	6 PK 2115
				ALT	FROM: 04.00; FROM MTR-NO: 002029; MTR-CODE: 111984; + MAN-TM; + AC	6 PK 2215
				ALT	FROM: 04.00; UNTIL MTR-NO: 000441; MTR-CODE: 111984; + AUTO-TM; - AC	6 PK 2100
				ALT	FROM: 04.00; UNTIL MTR-NO: 000441; MTR-CODE: 111984; + AUTO-TM; + AC	6 PK 2205
				ALT	FROM: 04.00; UNTIL MTR-NO: 002028; MTR-CODE: 111984; + MAN-TM; - AC	6 PK 2100
				ALT	FROM: 04.00; UNTIL MTR-NO: 002028; MTR-CODE: 111984; + MAN-TM; + AC	6 PK 2205
				ALT	UNTIL MTR-NO: 000441; MTR-CODE: 111979;111984; + AUTO-TM; - AC	6 PK 2100
				ALT	UNTIL MTR-NO: 000441; MTR-CODE: 111979;111984; + AUTO-TM; + AC	6 PK 2205
				ALT	UNTIL MTR-NO: 002028; MTR-CODE: 111979;111984; + MAN-TM; - AC	6 PK 2100
				ALT	UNTIL MTR-NO: 002028; MTR-CODE: 111979;111984; + MAN-TM; + AC	6 PK 2205

#### 208 CDI

2148 ccm	60 kW	OM 611.987	04.00 - 05.06	ALT	+ AC	6 PK 2270
				ALT	FROM CHA-NO.: 220798; - AC	6 PK 2260
				ALT	UNTIL CHA-NO.: 220797; - AC	6 PK 2191

#### 211 CDI

2148 ccm	80 kW	OM 611.981	04.00 - 05.06	ALT	+ AC	6 PK 2270
				ALT	FROM CHA-NO.: R220798; - AC	6 PK 2260
				ALT	UNTIL CHA-NO.: R220797; - AC	6 PK 2191

#### 213 CDI

2148 ccm	95 kW	OM 611.981	04.00 - 05.06	ALT	+ AC	6 PK 2270
				ALT	FROM CHA-NO.: R220798; - AC	6 PK 2260
				ALT	UNTIL CHA-NO.: R220797; - AC	6 PK 2191

#### 208 D

2299 ccm	58 kW	OM 601.943	01.95 - 04.00	ALT	- AC	6 PK 2020
				ALT	+ AC	6 PK 2100

#### 208 D

2299 ccm	60 kW	OM 601.943	09.96 - 04.00	ALT	- AC	6 PK 2020
				ALT	+ AC	6 PK 2100

#### 216 CDI

2685 ccm	115 kW	OM 612.981	04.00 - 05.06	ALT	+ AC	6 PK 2270
				ALT	FROM CHA-NO.: R220798; - AC	6 PK 2260
				ALT	UNTIL CHA-NO.: R220797; - AC	6 PK 2191

#### 210 D

2874 ccm	75 kW	OM 602.980	01.97 - 04.00	ALT	- AC	6 PK 2080
				ALT	+ AC	6 PK 2140

#### 212 D

2874 ccm	90 kW	OM 602.980	02.95 - 04.00	ALT	- AC	6 PK 2080
				ALT	+ AC	6 PK 2140

### SPRINTER 3-t Bus (903)

#### 314 NGT

2295 ccm	92 kW	M 111.984	04.00 - 05.06	ALT	FROM MTR-NO: 000442; + AUTO-TM; - AC	6 PK 2115
				ALT	FROM MTR-NO: 000442; + AUTO-TM; + AC	6 PK 2215
				ALT	UNTIL MTR-NO: 000441; + AUTO-TM; - AC	6 PK 2100
				ALT	UNTIL MTR-NO: 000441; + AUTO-TM; + AC	6 PK 2205

#### 314

2295 ccm	105 kW	M 111.984	02.95 - 05.06	ALT	FROM MTR-NO: 000442; + AUTO-TM; - AC	6 PK 2115
				ALT	FROM MTR-NO: 000442; + AUTO-TM; + AC	6 PK 2215
				ALT	FROM MTR-NO: 002029; + MAN-TM; - AC	6 PK 2115



## MERCEDES-BENZ

### SPRINTER 3-t Bus (903)

<b>314</b>							
2295 ccm	105 kW	M 111.984	02.95 - 05.06	ALT	FROM MTR-NO: 002029; + MAN-TM; + AC		6 PK 2215
				ALT	UNTIL MTR-NO: 000441; + AUTO-TM; - AC		6 PK 2100
				ALT	UNTIL MTR-NO: 000441; + AUTO-TM; + AC		6 PK 2205
				ALT	UNTIL MTR-NO: 002028; + MAN-TM; - AC		6 PK 2100
				ALT	UNTIL MTR-NO: 002028; + MAN-TM; + AC		6 PK 2205
<b>314 4x4</b>							
2295 ccm	105 kW	M 111.984	08.02 - 05.06	ALT	FROM MTR-NO: 000442; + AUTO-TM; - AC		6 PK 2115
				ALT	FROM MTR-NO: 000442; + AUTO-TM; + AC		6 PK 2215
				ALT	FROM MTR-NO: 002029; + MAN-TM; - AC		6 PK 2115
				ALT	FROM MTR-NO: 002029; + MAN-TM; + AC		6 PK 2215
				ALT	UNTIL MTR-NO: 000441; + AUTO-TM; - AC		6 PK 2100
				ALT	UNTIL MTR-NO: 000441; + AUTO-TM; + AC		6 PK 2205
				ALT	UNTIL MTR-NO: 002028; + MAN-TM; - AC		6 PK 2100
				ALT	UNTIL MTR-NO: 002028; + MAN-TM; + AC		6 PK 2205
<b>308 CDI</b>							
2148 ccm	60 kW	OM 611.987	04.00 - 05.06	ALT	+ AC		6 PK 2270
				ALT	FROM CHA-NO.: 220798; - AC		6 PK 2260
				ALT	UNTIL CHA-NO.: 220797; - AC		6 PK 2191
<b>311 CDI</b>							
2148 ccm	80 kW	OM 611.981	04.00 - 05.06	ALT	+ AC		6 PK 2270
				ALT	FROM CHA-NO.: R220798; - AC		6 PK 2260
				ALT	UNTIL CHA-NO.: R220797; - AC		6 PK 2191
<b>311 CDI 4x4</b>							
2148 ccm	80 kW	OM 611.981	08.02 - 05.06	ALT	+ AC		6 PK 2270
				ALT	FROM CHA-NO.: R220798; - AC		6 PK 2260
				ALT	UNTIL CHA-NO.: R220797; - AC		6 PK 2191
<b>313 CDI</b>							
2148 ccm	95 kW	OM 611.981	04.00 - 05.06	ALT	+ AC		6 PK 2270
				ALT	FROM CHA-NO.: R220798; - AC		6 PK 2260
				ALT	UNTIL CHA-NO.: R220797; - AC		6 PK 2191
<b>313 CDI 4x4</b>							
2148 ccm	95 kW	OM 611.981	08.02 - 05.06	ALT	+ AC		6 PK 2270
				ALT	FROM CHA-NO.: R220798; - AC		6 PK 2260
				ALT	UNTIL CHA-NO.: R220797; - AC		6 PK 2191
<b>308 D</b>							
2299 ccm	58 kW	OM 601.943	02.95 - 04.00	ALT	- AC		6 PK 2020
				ALT	+ AC		6 PK 2100
<b>316 CDI</b>							
2685 ccm	115 kW	OM 612.981	04.00 - 05.06	ALT	+ AC		6 PK 2270
				ALT	FROM CHA-NO.: R220798; - AC		6 PK 2260
				ALT	UNTIL CHA-NO.: R220797; - AC		6 PK 2191
<b>316 CDI 4x4</b>							
2685 ccm	115 kW	OM 612.981	08.02 - 05.06	ALT	+ AC		6 PK 2270
				ALT	FROM CHA-NO.: R220798; - AC		6 PK 2260
				ALT	UNTIL CHA-NO.: R220797; - AC		6 PK 2191
<b>310 D 4x4</b>							
2874 ccm	75 kW	OM 602.980	05.97 - 08.02	ALT	- AC		6 PK 2080
				ALT	+ AC		6 PK 2140
<b>312 D 2.9</b>							
2874 ccm	90 kW	OM 602.980	02.95 - 04.00	ALT	- AC		6 PK 2080
				ALT	+ AC		6 PK 2140
				ALT	UNTIL: 04.95; + AC		6 PK 2145
<b>312 D 2.9 4x4</b>							
2874 ccm	90 kW	OM 602.980	05.97 - 08.02	ALT	- AC		6 PK 2080
				ALT	+ AC		6 PK 2140
<b>SPRINTER 3-t Kasten (903)</b>							
<b>314 NGT</b>							
2295 ccm	92 kW		04.00 - 05.06	ALT	FROM MTR-NO: 000442; + AUTO-TM; - AC		6 PK 2115
				ALT	FROM MTR-NO: 000442; + AUTO-TM; + AC		6 PK 2215
				ALT	UNTIL MTR-NO: 000441; + AUTO-TM; - AC		6 PK 2100
				ALT	UNTIL MTR-NO: 000441; + AUTO-TM; + AC		6 PK 2205
<b>314</b>							
2295 ccm	105 kW	M 111.979; M 111.984	02.95 - 05.06	ALT	FROM MTR-NO: 000442; + AUTO-TM; - AC		6 PK 2115
				ALT	FROM MTR-NO: 000442; + AUTO-TM; + AC		6 PK 2215

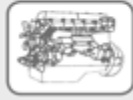

## MERCEDES-BENZ

### SPRINTER 3-t Kasten (903)

#### 314

2295 ccm	105 kW	M 111.979;M 111.984	02.95 - 05.06	ALT	FROM MTR-NO: 002029; + MAN-TM; - AC	6 PK 2115
				ALT	FROM MTR-NO: 002029; + MAN-TM; + AC	6 PK 2215
				ALT	UNTIL MTR-NO: 000441; + AUTO-TM; - AC	6 PK 2100
				ALT	UNTIL MTR-NO: 000441; + AUTO-TM; + AC	6 PK 2205
				ALT	UNTIL MTR-NO: 002028; + MAN-TM; - AC	6 PK 2100
				ALT	UNTIL MTR-NO: 002028; + MAN-TM; + AC	6 PK 2205

#### 314 4x4

2295 ccm	105 kW	M 111.984	08.02 - 05.06	ALT	FROM MTR-NO: 000442; + AUTO-TM; - AC	6 PK 2115
				ALT	FROM MTR-NO: 000442; + AUTO-TM; + AC	6 PK 2215
				ALT	FROM MTR-NO: 002029; + MAN-TM; - AC	6 PK 2115
				ALT	FROM MTR-NO: 002029; + MAN-TM; + AC	6 PK 2215
				ALT	UNTIL MTR-NO: 000441; + AUTO-TM; - AC	6 PK 2100
				ALT	UNTIL MTR-NO: 000441; + AUTO-TM; + AC	6 PK 2205
				ALT	UNTIL MTR-NO: 002028; + MAN-TM; - AC	6 PK 2100
				ALT	UNTIL MTR-NO: 002028; + MAN-TM; + AC	6 PK 2205

#### 308 CDI

2148 ccm	60 kW	OM 611.987	04.00 - 05.06	ALT	+ AC	6 PK 2270
				ALT	FROM CHA-NO.: 220798; - AC	6 PK 2260
				ALT	UNTIL CHA-NO.: 220797; - AC	6 PK 2191

#### 311 CDI

2148 ccm	80 kW	OM 611.981	04.00 - 05.06	ALT	+ AC	6 PK 2270
				ALT	FROM CHA-NO.: R220798; - AC	6 PK 2260
				ALT	UNTIL CHA-NO.: R220797; - AC	6 PK 2191

#### 311 CDI 4x4

2148 ccm	80 kW	OM 611.981	08.02 - 05.06	ALT	+ AC	6 PK 2270
				ALT	FROM CHA-NO.: R220798; - AC	6 PK 2260
				ALT	UNTIL CHA-NO.: R220797; - AC	6 PK 2191

#### 313 CDI

2148 ccm	95 kW	OM 611.981	04.00 - 05.06	ALT	+ AC	6 PK 2270
				ALT	FROM CHA-NO.: R220798; - AC	6 PK 2260
				ALT	UNTIL CHA-NO.: R220797; - AC	6 PK 2191

#### 313 CDI 4x4

2148 ccm	95 kW	OM 611.981	08.02 - 05.06	ALT	+ AC	6 PK 2270
				ALT	FROM CHA-NO.: R220798; - AC	6 PK 2260
				ALT	UNTIL CHA-NO.: R220797; - AC	6 PK 2191

#### 308 D 2.3

2299 ccm	58 kW	OM 601.943	02.95 - 04.00	ALT	- AC	6 PK 2020
				ALT	+ AC	6 PK 2100

#### 316 CDI

2685 ccm	115 kW	OM 612.981	04.00 - 05.06	ALT	+ AC	6 PK 2270
				ALT	FROM CHA-NO.: R220798; - AC	6 PK 2260
				ALT	UNTIL CHA-NO.: R220797; - AC	6 PK 2191

#### 316 CDI 4x4

2685 ccm	115 kW	OM 612.981	08.02 - 05.06	ALT	+ AC	6 PK 2270
				ALT	FROM CHA-NO.: R220798; - AC	6 PK 2260
				ALT	UNTIL CHA-NO.: R220797; - AC	6 PK 2191

#### 310 D 2.9

2874 ccm	75 kW	OM 602.980	02.95 - 04.00	ALT	- AC	6 PK 2080
				ALT	+ AC	6 PK 2140

#### 312 D 2.9

2874 ccm	90 kW	OM 602.980	02.95 - 04.00	ALT	- AC	6 PK 2080
				ALT	+ AC	6 PK 2140
				ALT	UNTIL: 04.95; + AC	6 PK 2145

#### 312 D 2.9 4x4

2874 ccm	90 kW	OM 602.980	05.97 - 08.02	ALT	- AC	6 PK 2080
				ALT	+ AC	6 PK 2140

### SPRINTER 3-t Pritsche/Fahrgestell (903)

#### 314 NGT

2295 ccm	92 kW		04.00 - 05.06	ALT	FROM MTR-NO: 000442; MTR-CODE: 111984; + AUTO-TM; - AC	6 PK 2115
				ALT	FROM MTR-NO: 000442; MTR-CODE: 111984; + AUTO-TM; + AC	6 PK 2215
				ALT	UNTIL MTR-NO: 000441; MTR-CODE: 111984; + AUTO-TM; - AC	6 PK 2100



## MERCEDES-BENZ

### SPRINTER 3-t Pritsche/Fahrgestell (903)

#### 314 NGT

2295 ccm	92 kW		04.00 - 05.06	ALT	UNTIL MTR-NO: 000441; MTR-CODE: 111984; + AUTO-TM; + AC	<b>6 PK 2205</b>
----------	-------	--	---------------	-----	--	------------------

#### 314

2295 ccm	105 kW	M 111.984	02.95 - 05.06	ALT	FROM MTR-NO: 000442; MTR-CODE: 111979;111984; + AUTO-TM; - AC	<b>6 PK 2115</b>
				ALT	FROM MTR-NO: 000442; MTR-CODE: 111979;111984; + AUTO-TM; + AC	<b>6 PK 2215</b>
				ALT	FROM MTR-NO: 002029; MTR-CODE: 111979;111984; + MAN-TM; - AC	<b>6 PK 2115</b>
				ALT	FROM MTR-NO: 002029; MTR-CODE: 111979;111984; + MAN-TM; + AC	<b>6 PK 2215</b>
				ALT	FROM: 04.00; FROM MTR-NO: 000442; MTR- CODE: 111984; + AUTO-TM; - AC	<b>6 PK 2115</b>
				ALT	FROM: 04.00; FROM MTR-NO: 000442; MTR- CODE: 111984; + AUTO-TM; + AC	<b>6 PK 2215</b>
				ALT	FROM: 04.00; FROM MTR-NO: 002029; MTR- CODE: 111984; + MAN-TM; - AC	<b>6 PK 2115</b>
				ALT	FROM: 04.00; FROM MTR-NO: 002029; MTR- CODE: 111984; + MAN-TM; + AC	<b>6 PK 2215</b>
				ALT	FROM: 04.00; UNTIL MTR-NO: 000441; MTR- CODE: 111984; + AUTO-TM; - AC	<b>6 PK 2100</b>
				ALT	FROM: 04.00; UNTIL MTR-NO: 000441; MTR- CODE: 111984; + AUTO-TM; + AC	<b>6 PK 2205</b>
				ALT	FROM: 04.00; UNTIL MTR-NO: 002028; MTR- CODE: 111984; + MAN-TM; - AC	<b>6 PK 2100</b>
				ALT	FROM: 04.00; UNTIL MTR-NO: 002028; MTR- CODE: 111984; + MAN-TM; + AC	<b>6 PK 2205</b>
				ALT	UNTIL MTR-NO: 000441; MTR-CODE: 111979;111984; + AUTO-TM; - AC	<b>6 PK 2100</b>
				ALT	UNTIL MTR-NO: 000441; MTR-CODE: 111979;111984; + AUTO-TM; + AC	<b>6 PK 2205</b>
				ALT	UNTIL MTR-NO: 002028; MTR-CODE: 111979;111984; + MAN-TM; - AC	<b>6 PK 2100</b>
				ALT	UNTIL MTR-NO: 002028; MTR-CODE: 111979;111984; + MAN-TM; + AC	<b>6 PK 2205</b>

#### 314 4x4

2295 ccm	105 kW	M 111.984	08.02 - 05.06	ALT	FROM MTR-NO: 000442; + AUTO-TM; - AC	<b>6 PK 2115</b>
				ALT	FROM MTR-NO: 000442; + AUTO-TM; + AC	<b>6 PK 2215</b>
				ALT	FROM MTR-NO: 002029; + MAN-TM; - AC	<b>6 PK 2115</b>
				ALT	FROM MTR-NO: 002029; + MAN-TM; + AC	<b>6 PK 2215</b>
				ALT	UNTIL MTR-NO: 000441; + AUTO-TM; - AC	<b>6 PK 2100</b>
				ALT	UNTIL MTR-NO: 000441; + AUTO-TM; + AC	<b>6 PK 2205</b>
				ALT	UNTIL MTR-NO: 002028; + MAN-TM; - AC	<b>6 PK 2100</b>
				ALT	UNTIL MTR-NO: 002028; + MAN-TM; + AC	<b>6 PK 2205</b>

#### 308 CDI

2148 ccm	60 kW	OM 611.987	04.00 - 05.06	ALT	+ AC	<b>6 PK 2270</b>
				ALT	FROM CHA-NO.: R220798; - AC	<b>6 PK 2260</b>
				ALT	UNTIL CHA-NO.: R220797; - AC	<b>6 PK 2191</b>

#### 311 CDI

2148 ccm	80 kW	OM 611.981	04.00 - 05.06	ALT	+ AC	<b>6 PK 2270</b>
				ALT	FROM CHA-NO.: R220798; - AC	<b>6 PK 2260</b>
				ALT	UNTIL CHA-NO.: R220797; - AC	<b>6 PK 2191</b>

#### 311 CDI 4x4

2148 ccm	80 kW	OM 611.981	08.02 - 05.06	ALT	+ AC	<b>6 PK 2270</b>
				ALT	FROM CHA-NO.: R220798; - AC	<b>6 PK 2260</b>
				ALT	UNTIL CHA-NO.: R220797; - AC	<b>6 PK 2191</b>

#### 313 CDI

2148 ccm	95 kW	OM 611.981	04.00 - 05.06	ALT	+ AC	<b>6 PK 2270</b>
				ALT	FROM CHA-NO.: R220798; - AC	<b>6 PK 2260</b>
				ALT	UNTIL CHA-NO.: R220797; - AC	<b>6 PK 2191</b>

#### 313 CDI 4x4

2148 ccm	95 kW	OM 611.981	08.02 - 05.06	ALT	+ AC	<b>6 PK 2270</b>
				ALT	FROM CHA-NO.: R220798; - AC	<b>6 PK 2260</b>
				ALT	UNTIL CHA-NO.: R220797; - AC	<b>6 PK 2191</b>

#### 308 D 2.3

2299 ccm	58 kW	OM 601.943	02.95 - 04.00	ALT	- AC	<b>6 PK 2020</b>
				ALT	+ AC	<b>6 PK 2100</b>

#### 308 D 2.3

2299 ccm	60 kW	OM 601.943	11.96 - 04.00	ALT	- AC	<b>6 PK 2020</b>
----------	-------	------------	---------------	-----	------	------------------





## MERCEDES-BENZ

### SPRINTER 3-t Pritsche/Fahrgestell (903)

#### 308 D 2.3

2299 ccm 60 kW OM 601.943 11.96 - 04.00 ALT + AC 6 PK 2100

#### 316 CDI

2685 ccm 115 kW OM 612.981 04.00 - 05.06 ALT + AC 6 PK 2270  
ALT FROM CHA-NO.: R220798; - AC 6 PK 2260  
ALT UNTIL CHA-NO.: R220797; - AC 6 PK 2191

#### 316 CDI 4x4

2685 ccm 115 kW OM 612.981 08.02 - 05.06 ALT + AC 6 PK 2270  
ALT FROM CHA-NO.: R220798; - AC 6 PK 2260  
ALT UNTIL CHA-NO.: R220797; - AC 6 PK 2191

#### 310 D 2.9

2874 ccm 75 kW OM 602.980 01.97 - 04.00 ALT - AC 6 PK 2080  
ALT + AC 6 PK 2140

#### 312 D 2.9

2874 ccm 90 kW OM 602.980 02.95 - 04.00 ALT - AC 6 PK 2080  
ALT + AC 6 PK 2140  
ALT UNTIL: 04.95; + AC 6 PK 2145

### SPRINTER 4-t Bus (904)

#### 414

2295 ccm 105 kW M 111.979 02.96 - 05.06 ALT FROM MTR-NO: 000442; + AUTO-TM; - AC 6 PK 2115  
ALT FROM MTR-NO: 000442; + AUTO-TM; + AC 6 PK 2215  
ALT FROM MTR-NO: 002029; + MAN-TM; - AC 6 PK 2115  
ALT FROM MTR-NO: 002029; + MAN-TM; + AC 6 PK 2215  
ALT UNTIL MTR-NO: 000441; + AUTO-TM; - AC 6 PK 2100  
ALT UNTIL MTR-NO: 000441; + AUTO-TM; + AC 6 PK 2205  
ALT UNTIL MTR-NO: 002028; + MAN-TM; - AC 6 PK 2100  
ALT UNTIL MTR-NO: 002028; + MAN-TM; + AC 6 PK 2205

#### 408 CDI

2148 ccm 60 kW OM 611.987 04.00 - 05.06 ALT + AC 6 PK 2270  
ALT FROM CHA-NO.: 220798; - AC 6 PK 2260  
ALT UNTIL CHA-NO.: 220797; - AC 6 PK 2191

#### 411 CDI

2148 ccm 80 kW OM 611.981 04.00 - 05.06 ALT + AC 6 PK 2270  
ALT FROM CHA-NO.: R220798; - AC 6 PK 2260  
ALT UNTIL CHA-NO.: R220797; - AC 6 PK 2191

#### 413 CDI

2148 ccm 95 kW OM 611.981 04.00 - 05.06 ALT + AC 6 PK 2270  
ALT FROM CHA-NO.: R220798; - AC 6 PK 2260  
ALT UNTIL CHA-NO.: R220797; - AC 6 PK 2191

#### 416 CDI

2685 ccm 115 kW OM 612.981 04.00 - 05.06 ALT + AC 6 PK 2270  
ALT FROM CHA-NO.: R220798; - AC 6 PK 2260  
ALT UNTIL CHA-NO.: R220797; - AC 6 PK 2191

### SPRINTER 4-t Kasten (904)

#### 414

2295 ccm 105 kW M 111.979 02.96 - 05.06 ALT FROM MTR-NO: 000442; + AUTO-TM; - AC 6 PK 2115  
ALT FROM MTR-NO: 000442; + AUTO-TM; + AC 6 PK 2215  
ALT FROM MTR-NO: 002029; + MAN-TM; - AC 6 PK 2115  
ALT FROM MTR-NO: 002029; + MAN-TM; + AC 6 PK 2215  
ALT UNTIL MTR-NO: 000441; + AUTO-TM; - AC 6 PK 2100  
ALT UNTIL MTR-NO: 000441; + AUTO-TM; + AC 6 PK 2205  
ALT UNTIL MTR-NO: 002028; + MAN-TM; - AC 6 PK 2100  
ALT UNTIL MTR-NO: 002028; + MAN-TM; + AC 6 PK 2205

#### 414 4x4

2295 ccm 105 kW M 111.979 05.97 - 05.06 ALT FROM MTR-NO: 000442; + AUTO-TM; - AC 6 PK 2115  
ALT FROM MTR-NO: 000442; + AUTO-TM; + AC 6 PK 2215  
ALT FROM MTR-NO: 002029; + MAN-TM; - AC 6 PK 2115  
ALT FROM MTR-NO: 002029; + MAN-TM; + AC 6 PK 2215  
ALT UNTIL MTR-NO: 000441; + AUTO-TM; - AC 6 PK 2100  
ALT UNTIL MTR-NO: 000441; + AUTO-TM; + AC 6 PK 2205  
ALT UNTIL MTR-NO: 002028; + MAN-TM; - AC 6 PK 2100  
ALT UNTIL MTR-NO: 002028; + MAN-TM; + AC 6 PK 2205

#### 408 CDI

2148 ccm 60 kW OM 611.987 04.00 - 05.06 ALT + AC 6 PK 2270  
ALT FROM CHA-NO.: 220798; - AC 6 PK 2260



## MERCEDES-BENZ

### SPRINTER 4-t Kasten (904)

#### 408 CDI

2148 ccm	60 kW	OM 611.987	04.00 - 05.06	ALT	UNTIL CHA-NO.: 220797; - AC	6 PK 2191
----------	-------	------------	---------------	-----	-----------------------------	-----------

#### 411 CDI

2148 ccm	80 kW	OM 611.981	04.00 - 05.06	ALT	+ AC	6 PK 2270
				ALT	FROM CHA-NO.: R220798; - AC	6 PK 2260
				ALT	UNTIL CHA-NO.: R220797; - AC	6 PK 2191

#### 411 CDI 4x4

2148 ccm	80 kW	OM 611.981	04.00 - 05.06	ALT	+ AC	6 PK 2270
				ALT	FROM CHA-NO.: R220798; - AC	6 PK 2260
				ALT	UNTIL CHA-NO.: R220797; - AC	6 PK 2191

#### 413 CDI

2148 ccm	95 kW	OM 611.981	04.00 - 05.06	ALT	+ AC	6 PK 2270
				ALT	FROM CHA-NO.: R220798; - AC	6 PK 2260
				ALT	UNTIL CHA-NO.: R220797; - AC	6 PK 2191

#### 413 CDI 4x4

2148 ccm	95 kW	OM 611.981	04.00 - 05.06	ALT	+ AC	6 PK 2270
				ALT	FROM CHA-NO.: R220798; - AC	6 PK 2260
				ALT	UNTIL CHA-NO.: R220797; - AC	6 PK 2191

#### 408 D

2299 ccm	58 kW	OM 601.943	02.96 - 05.06	ALT	- AC	6 PK 2020
				ALT	+ AC	6 PK 2100

#### 416 CDI

2685 ccm	115 kW	OM 612.981	04.00 - 05.06	ALT	+ AC	6 PK 2270
				ALT	FROM CHA-NO.: R220798; - AC	6 PK 2260
				ALT	UNTIL CHA-NO.: R220797; - AC	6 PK 2191

#### 416 CDI 4x4

2685 ccm	115 kW	OM 612.981	04.00 - 05.06	ALT	+ AC	6 PK 2270
				ALT	FROM CHA-NO.: R220798; - AC	6 PK 2260
				ALT	UNTIL CHA-NO.: R220797; - AC	6 PK 2191

#### 410 D

2874 ccm	75 kW	OM 602.980	02.96 - 05.06	ALT	FROM: 01.97; - AC	6 PK 2080
				ALT	FROM: 01.97; + AC	6 PK 2140

#### 410 D 4x4

2874 ccm	75 kW	OM 602.980	05.97 - 05.06	ALT	- AC	6 PK 2080
				ALT	+ AC	6 PK 2140

#### 412 D

2874 ccm	85 kW	OM 602.980	02.96 - 05.06	ALT	- AC	6 PK 2080
				ALT	+ AC	6 PK 2140

#### 412 D 4x4

2874 ccm	85 kW	OM 602.980	05.97 - 05.06	ALT	- AC	6 PK 2080
				ALT	+ AC	6 PK 2140

#### 412 D

2874 ccm	90 kW	OM 602.980	02.96 - 05.06	ALT	- AC	6 PK 2080
				ALT	+ AC	6 PK 2140

#### 412 D 4x4

2874 ccm	90 kW	OM 602.980	05.97 - 05.06	ALT	- AC	6 PK 2080
				ALT	+ AC	6 PK 2140

### SPRINTER 4-t Pritsche/Fahrgestell (904)

#### 414

2295 ccm	105 kW	M 111.979	02.96 - 05.06	ALT	FROM MTR-NO: 000442; MTR-CODE: 111979;111984; + AUTO-TM; - AC	6 PK 2115
				ALT	FROM MTR-NO: 000442; MTR-CODE: 111979;111984; + AUTO-TM; + AC	6 PK 2215
				ALT	FROM MTR-NO: 002029; MTR-CODE: 111979;111984; + MAN-TM; - AC	6 PK 2115
				ALT	FROM MTR-NO: 002029; MTR-CODE: 111979;111984; + MAN-TM; + AC	6 PK 2215
				ALT	FROM: 04.00; FROM MTR-NO: 000442; MTR-CODE: 111984; + AUTO-TM; - AC	6 PK 2115
				ALT	FROM: 04.00; FROM MTR-NO: 000442; MTR-CODE: 111984; + AUTO-TM; + AC	6 PK 2215
				ALT	FROM: 04.00; FROM MTR-NO: 002029; MTR-CODE: 111984; + MAN-TM; - AC	6 PK 2115
				ALT	FROM: 04.00; FROM MTR-NO: 002029; MTR-CODE: 111984; + MAN-TM; + AC	6 PK 2215
				ALT	FROM: 04.00; UNTIL MTR-NO: 000441; MTR-CODE: 111984; + AUTO-TM; - AC	6 PK 2100



## MERCEDES-BENZ

### SPRINTER 4-t Pritsche/Fahrgestell (904)

#### 414

2295 ccm	105 kW	M 111.979	02.96 - 05.06	ALT	FROM: 04.00; UNTIL MTR-NO: 000441; MTR-CODE: 111984; + AUTO-TM; + AC	6 PK 2205
				ALT	FROM: 04.00; UNTIL MTR-NO: 002028; MTR-CODE: 111984; + MAN-TM; - AC	6 PK 2100
				ALT	FROM: 04.00; UNTIL MTR-NO: 002028; MTR-CODE: 111984; + MAN-TM; + AC	6 PK 2205
				ALT	UNTIL MTR-NO: 000441; MTR-CODE: 111979;111984; + AUTO-TM; - AC	6 PK 2100
				ALT	UNTIL MTR-NO: 000441; MTR-CODE: 111979;111984; + AUTO-TM; + AC	6 PK 2205
				ALT	UNTIL MTR-NO: 002028; MTR-CODE: 111979;111984; + MAN-TM; - AC	6 PK 2100
				ALT	UNTIL MTR-NO: 002028; MTR-CODE: 111979;111984; + MAN-TM; + AC	6 PK 2205

#### 414 4x4

2295 ccm	105 kW	M 111.979	05.97 - 05.06	ALT	FROM MTR-NO: 000442; + AUTO-TM; - AC	6 PK 2115
				ALT	FROM MTR-NO: 000442; + AUTO-TM; + AC	6 PK 2215
				ALT	FROM MTR-NO: 002029; + MAN-TM; - AC	6 PK 2115
				ALT	FROM MTR-NO: 002029; + MAN-TM; + AC	6 PK 2215
				ALT	UNTIL MTR-NO: 000441; + AUTO-TM; - AC	6 PK 2100
				ALT	UNTIL MTR-NO: 000441; + AUTO-TM; + AC	6 PK 2205
				ALT	UNTIL MTR-NO: 002028; + MAN-TM; - AC	6 PK 2100
				ALT	UNTIL MTR-NO: 002028; + MAN-TM; + AC	6 PK 2205

#### 408 CDI

2148 ccm	60 kW	OM 611.987	04.00 - 05.06	ALT	+ AC	6 PK 2270
				ALT	FROM CHA-NO.: R220798; - AC	6 PK 2260
				ALT	UNTIL CHA-NO.: R220797; - AC	6 PK 2191

#### 411 CDI

2148 ccm	80 kW	OM 611.981	04.00 - 05.06	ALT	+ AC	6 PK 2270
				ALT	FROM CHA-NO.: R220798; - AC	6 PK 2260
				ALT	UNTIL CHA-NO.: R220797; - AC	6 PK 2191

#### 411 CDI 4x4

2148 ccm	80 kW	OM 611.981	04.00 - 05.06	ALT	+ AC	6 PK 2270
				ALT	FROM CHA-NO.: R220798; - AC	6 PK 2260
				ALT	UNTIL CHA-NO.: R220797; - AC	6 PK 2191

#### 413 CDI

2148 ccm	95 kW	OM 611.981	04.00 - 05.06	ALT	+ AC	6 PK 2270
				ALT	FROM CHA-NO.: R220798; - AC	6 PK 2260
				ALT	UNTIL CHA-NO.: R220797; - AC	6 PK 2191

#### 413 CDI 4x4

2148 ccm	95 kW	OM 611.981	04.00 - 05.06	ALT	+ AC	6 PK 2270
				ALT	FROM CHA-NO.: R220798; - AC	6 PK 2260
				ALT	UNTIL CHA-NO.: R220797; - AC	6 PK 2191

#### 408 D

2299 ccm	58 kW	OM 601.943	02.96 - 05.06	ALT	- AC	6 PK 2020
				ALT	+ AC	6 PK 2100

#### 416 CDI

2685 ccm	115 kW	OM 612.981	04.00 - 05.06	ALT	+ AC	6 PK 2270
				ALT	FROM CHA-NO.: R220798; - AC	6 PK 2260
				ALT	UNTIL CHA-NO.: R220797; - AC	6 PK 2191

#### 416 CDI 4x4

2685 ccm	115 kW	OM 612.981	04.00 - 05.06	ALT	+ AC	6 PK 2270
				ALT	FROM CHA-NO.: R220798; - AC	6 PK 2260
				ALT	UNTIL CHA-NO.: R220797; - AC	6 PK 2191

#### 410 D

2874 ccm	75 kW	OM 602.980	02.96 - 05.06	ALT	FROM: 01.97; - AC	6 PK 2080
				ALT	FROM: 01.97; + AC	6 PK 2140

#### 410 D 4x4

2874 ccm	75 kW	OM 602.980	05.97 - 05.06	ALT	- AC	6 PK 2080
				ALT	+ AC	6 PK 2140

#### 412 D

2874 ccm	85 kW	OM 602.980	02.96 - 05.06	ALT	- AC	6 PK 2080
				ALT	+ AC	6 PK 2140

#### 412 D 4x4

2874 ccm	85 kW	OM 602.980	05.97 - 05.06	ALT	- AC	6 PK 2080
				ALT	+ AC	6 PK 2140



## MERCEDES-BENZ

### SPRINTER 4-t Pritsche/Fahrgestell (904)

<b>412 D</b>							
2874 ccm	90 kW	OM 602.980	02.96 - 05.06	ALT	- AC		6 PK 2080
				ALT	+ AC		6 PK 2140
<b>412 D 4x4</b>							
2874 ccm	90 kW	OM 602.980	05.97 - 05.06	ALT	- AC		6 PK 2080
				ALT	+ AC		6 PK 2140

### SPRINTER 3-t Bus (906)

<b>224 (906.713)</b>							
3498 ccm	190 kW	M 272.979	06.06 -	ALT			6 PK 2404
<b>210 CDI (906.711, 906.713)</b>							
2143 ccm	70 kW	OM 651.955	03.09 -	ALT	- AC		6 PK 2080
				ALT	+ AC		6 PK 2140
<b>211 CDI (906.711, 906.713)</b>							
2148 ccm	80 kW	OM 646.985	06.06 -	ALT	- ENG-PTO		6 PK 2260
				ALT	+ ENG-PTO		6 PK 2285
<b>215 CDI (906.711, 906.713)</b>							
2148 ccm	110 kW	OM 646.989;OM 646.990	06.06 -	ALT	- ENG-PTO		6 PK 2260
				ALT	+ ENG-PTO		6 PK 2285

### SPRINTER 3-t Kasten (906)

<b>224 (906.613)</b>							
3498 ccm	190 kW	M 272.979	06.06 -	ALT			6 PK 2404
<b>209 CDI (906.611, 906.613)</b>							
2148 ccm	65 kW	OM 646.984	06.06 -	ALT	- ENG-PTO		6 PK 2260
				ALT	+ ENG-PTO		6 PK 2285
<b>210 CDI (906.611, 906.613)</b>							
2143 ccm	70 kW	OM 651.955	03.09 -	ALT			6 PK 2215
<b>211 CDI (906.611, 906.613)</b>							
2148 ccm	80 kW	OM 646.985	06.06 -	ALT	- ENG-PTO		6 PK 2260
				ALT	+ ENG-PTO		6 PK 2285
<b>213 CDI (906.611, 906.613)</b>							
2148 ccm	95 kW	OM 646.986	06.06 -	ALT	- ENG-PTO		6 PK 2260
				ALT	+ ENG-PTO		6 PK 2285
<b>215 CDI (906.611, 906.613)</b>							
2148 ccm	110 kW	OM 646.989;OM 646.990	06.06 -	ALT	- ENG-PTO		6 PK 2260
				ALT	+ ENG-PTO		6 PK 2285
<b>216 CDI (906.611, 906.613)</b>							
2143 ccm	120 kW	OM 651.957	03.09 -	ALT			6 PK 2215
<b>218 CDI (906.611, 906.613)</b>							
2987 ccm	135 kW	OM 642.896;OM 642.992	06.06 -	ALT	- ENG-PTO		7 PK 2035
				FAN	OE-NO.: 0019933896		6 EPK 691
<b>219 CDI (906.611, 906.613)</b>							
2987 ccm	140 kW	OM 642.896;OM 642.992	03.09 -	ALT	- ENG-PTO		7 PK 2035

### SPRINTER 3-t Pritsche/Fahrgestell (906)

<b>224 (906.113, 906.213)</b>							
3498 ccm	190 kW	M 272.979	06.06 -	ALT			6 PK 2404
<b>209 CDI (906.111, 906.113, 906.211, 906.213)</b>							
2148 ccm	65 kW	OM 646.984	06.06 -	ALT	- ENG-PTO		6 PK 2260
				ALT	+ ENG-PTO		6 PK 2285
<b>210 CDI (906.111, 906.113, 906.211, 906.213)</b>							
2143 ccm	70 kW	OM 651.955	03.09 -	ALT	MTR-CODE: 651955		6 PK 2215
<b>211 CDI (906.111, 906.113, 906.211, 906.213)</b>							
2148 ccm	80 kW	OM 646.985	06.06 -	ALT	- ENG-PTO		6 PK 2260
				ALT	+ ENG-PTO		6 PK 2285
<b>213 CDI (906.111, 906.113, 906.211, 906.213)</b>							
2143 ccm	95 kW	OM 651.956	03.09 -	ALT	MTR-CODE: 651956		6 PK 2215
<b>213 CDI (906.111, 906.113, 906.211, 906.213)</b>							
2148 ccm	95 kW	OM 646.986	06.06 -	ALT	- ENG-PTO		6 PK 2260
				ALT	+ ENG-PTO		6 PK 2285
<b>215 CDI (906.111, 906.113, 906.211, 906.213)</b>							
2148 ccm	110 kW	OM 646.989;OM 646.990	06.06 -	ALT	MTR-CODE: 646989; - ENG-PTO		6 PK 2260
				ALT	MTR-CODE: 646989; + ENG-PTO		6 PK 2285
<b>216 CDI (906.111, 906.113, 906.211, 906.213)</b>							
2143 ccm	120 kW	OM 651.957	03.09 -	ALT	MTR-CODE: 651957		6 PK 2215



## MERCEDES-BENZ

### SPRINTER 3-t Pritsche/Fahrgestell (906)

#### 218 CDI (906.111, 906.113, 906.211, 906.213)

2987 ccm	135 kW	OM 642.896;OM 642.992;OM 642.993	06.06 -	ALT	MTR-CODE: 642896; - ENG-PTO	7 PK 2035
				ALT FAN	MTR-CODE: 642992; - ENG-PTO OE-NO.: 0019933896	7 PK 2035 6 EPK 691

#### 219 CDI (906.111, 906.113, 906.211, 906.213)

2987 ccm	140 kW	OM 642.896;OM 642.992	03.09 -	ALT	MTR-CODE: 642992; - ENG-PTO	7 PK 2035
----------	--------	-----------------------	---------	-----	-----------------------------	-----------

### SPRINTER 3,5-t Bus (906)

#### 324 (906.733, 906.735)

3498 ccm	190 kW	M 272.979	06.06 -	ALT		6 PK 2404
----------	--------	-----------	---------	-----	--	-----------

#### 310 CDI (906.731, 906.733, 906.735)

2143 ccm	70 kW	OM 651.955	03.09 -	ALT		6 PK 2215
----------	-------	------------	---------	-----	--	-----------

#### 311 CDI (906.731, 906.733, 906.735)

2148 ccm	80 kW	OM 646.985	06.06 -	ALT	- ENG-PTO	6 PK 2260
				ALT	+ ENG-PTO	6 PK 2285

#### 311 CDI 4x4 (906.731, 906.733, 906.735)

2148 ccm	80 kW	OM 646.985	02.08 -	ALT	- ENG-PTO	6 PK 2260
				ALT	+ ENG-PTO	6 PK 2285

#### 315 CDI (906.731, 906.733, 906.735)

2148 ccm	110 kW	OM 646.989;OM 646.990	06.06 -	ALT	- ENG-PTO	6 PK 2260
				ALT	+ ENG-PTO	6 PK 2285

#### 315 CDI 4x4 (906.731, 906.733, 906.735)

2148 ccm	110 kW	OM 646.989;OM 646.990	02.08 -	ALT	- ENG-PTO	6 PK 2260
				ALT	+ ENG-PTO	6 PK 2285

#### 318 CDI 4x4 (906.731, 906.733, 906.735)

2987 ccm	135 kW	OM 642.896;OM 642.992;OM 642.993	02.08 -	ALT	- ENG-PTO	7 PK 2035
----------	--------	----------------------------------	---------	-----	-----------	-----------

### SPRINTER 3,5-t Kasten (906)

#### 324 (906.633, 906.635, 906.637)

3498 ccm	190 kW	M 272.979	06.06 -	ALT		6 PK 2404
----------	--------	-----------	---------	-----	--	-----------

#### 309 CDI (906.631, 906.633, 906.635, 906.637)

2148 ccm	65 kW	OM 646.984	06.06 -	ALT	- ENG-PTO	6 PK 2260
				ALT	+ ENG-PTO	6 PK 2285

#### 310 CDI (906.631, 906.633, 906.635, 906.637)

2143 ccm	70 kW	OM 651.955	03.09 -	ALT		6 PK 2215
----------	-------	------------	---------	-----	--	-----------

#### 311 CDI (906.631, 906.633, 906.635, 906.637)

2148 ccm	80 kW	OM 646.985	06.06 -	ALT	- ENG-PTO	6 PK 2260
				ALT	+ ENG-PTO	6 PK 2285

#### 311 CDI 4x4 (906.631, 906.633, 906.635, 906.637)

2148 ccm	80 kW	OM 646.985	02.08 -	ALT	- ENG-PTO	6 PK 2260
				ALT	+ ENG-PTO	6 PK 2285

#### 313 CDI (906.631, 906.633, 906.635, 906.637)

2148 ccm	95 kW	OM 646.986	06.06 -	ALT	- ENG-PTO	6 PK 2260
				ALT	+ ENG-PTO	6 PK 2285

#### 315 CDI (906.631, 906.633, 906.635, 906.637)

2148 ccm	110 kW	OM 646.989;OM 646.990	06.06 -	ALT	- ENG-PTO	6 PK 2260
				ALT	+ ENG-PTO	6 PK 2285

#### 315 CDI 4x4 (906.631, 906.633, 906.635, 906.637)

2148 ccm	110 kW	OM 646.989;OM 646.990	02.08 -	ALT	- ENG-PTO	6 PK 2260
				ALT	+ ENG-PTO	6 PK 2285

#### 316 CDI (906.631, 906.633, 906.635, 906.637)

2143 ccm	120 kW	OM 651.957	03.09 -	ALT		6 PK 2215
----------	--------	------------	---------	-----	--	-----------

#### 316 CDI 4x4 (906.631, 906.633, 906.635, 906.637)

2143 ccm	120 kW	OM 651.957	03.09 -	ALT		6 PK 2215
----------	--------	------------	---------	-----	--	-----------

#### 318 CDI (906.631, 906.633, 906.635, 906.637)

2987 ccm	135 kW	OM 642.896;OM 642.992;OM 642.993	06.06 -	ALT	- ENG-PTO	7 PK 2035
				FAN	OE-NO.: 0019933896	6 EPK 691

#### 318 CDI 4x4 (906.631, 906.633, 906.635, 906.637)

2987 ccm	135 kW	OM 642.896;OM 642.992;OM 642.993	02.08 -	ALT	- ENG-PTO	7 PK 2035
----------	--------	----------------------------------	---------	-----	-----------	-----------

#### 319 CDI (906.631, 906.633, 906.635, 906.637)

2987 ccm	140 kW	OM 642.896;OM 642.898;OM 642.992	03.09 -	ALT	- ENG-PTO	7 PK 2035
----------	--------	----------------------------------	---------	-----	-----------	-----------



## MERCEDES-BENZ

### SPRINTER 3,5 Pritsche/Fahrgestell (906)

#### 324 (906.133, 906.135, 906.233, 906.235)

3498 ccm	190 kW	M 272.979	06.06 -	ALT		6 PK 2404
----------	--------	-----------	---------	-----	--	-----------

#### 309 CDI (906.131, 906.133, 906.135, 906.231, 906.233...)

2148 ccm	65 kW	OM 646.984	06.06 -	ALT	- ENG-PTO	6 PK 2260
				ALT	+ ENG-PTO	6 PK 2285

#### 310 CDI (906.131, 906.133, 906.135, 906.231, 906.233...)

2143 ccm	70 kW	OM 651.955	03.09 -	ALT	MTR-CODE: 651955	6 PK 2215
----------	-------	------------	---------	-----	------------------	-----------

#### 311 CDI (906.131, 906.133, 906.135, 906.231, 906.233...)

2148 ccm	80 kW	OM 646.985	06.06 -	ALT	- ENG-PTO	6 PK 2260
				ALT	+ ENG-PTO	6 PK 2285

#### 311 CDI 4x4 (906.131, 906.133, 906.135, 906.231...)

2148 ccm	80 kW	OM 646.985	02.08 -	ALT	- ENG-PTO	6 PK 2260
				ALT	+ ENG-PTO	6 PK 2285

#### 313 CDI (906.131, 906.133, 906.135, 906.231, 906.233...)

2148 ccm	95 kW	OM 646.986	06.06 -	ALT	- ENG-PTO	6 PK 2260
				ALT	+ ENG-PTO	6 PK 2285

#### 315 CDI (906.131, 906.133, 906.135, 906.231, 906.233...)

2148 ccm	110 kW	OM 646.989;OM 646.990	06.06 -	ALT	- ENG-PTO	6 PK 2260
				ALT	+ ENG-PTO	6 PK 2285

#### 315 CDI 4x4 (906.131, 906.133, 906.135, 906.231...)

2148 ccm	110 kW	OM 646.989;OM 646.990	02.08 -	ALT	- ENG-PTO	6 PK 2260
				ALT	+ ENG-PTO	6 PK 2285

#### 316 CDI (906.131, 906.133, 906.135, 906.231, 906.233...)

2143 ccm	120 kW	OM 651.957	03.09 -	ALT	MTR-CODE: 651957	6 PK 2215
----------	--------	------------	---------	-----	------------------	-----------

#### 316 CDI 4x4 (906.131, 906.133, 906.135, 906.231...)

2143 ccm	120 kW	OM 651.957	03.09 -	ALT	MTR-CODE: 651957	6 PK 2215
----------	--------	------------	---------	-----	------------------	-----------

#### 318 CDI (906.131, 906.133, 906.135, 906.231, 906.233...)

2987 ccm	135 kW	OM 642.896;OM 642.992;OM 642.993	06.06 -	ALT	MTR-CODE: 642896; - ENG-PTO	7 PK 2035
----------	--------	----------------------------------	---------	-----	-----------------------------	-----------

				ALT	MTR-CODE: 642896;642992; - ENG-PTO	7 PK 2035
				FAN	OE-NO.: 0019933896	6 EPK 691

#### 318 CDI 4x4 (906.131, 906.133, 906.135, 906.231...)

2987 ccm	135 kW	OM 642.896;OM 642.992;OM 642.993	02.08 -	ALT	MTR-CODE: 642896; - ENG-PTO	7 PK 2035
----------	--------	----------------------------------	---------	-----	-----------------------------	-----------

				ALT	MTR-CODE: 642992; - ENG-PTO	7 PK 2035
--	--	--	--	-----	-----------------------------	-----------

#### 319 CDI (906.131, 906.133, 906.135, 906.231, 906.233...)

2987 ccm	140 kW	OM 642.896;OM 642.898;OM 642.992	03.09 -	ALT	MTR-CODE: 642992; - ENG-PTO	7 PK 2035
----------	--------	----------------------------------	---------	-----	-----------------------------	-----------

### SPRINTER 4,6-t Kasten (906)

#### 424 (906.953, 906.655, 906.657)

3498 ccm	190 kW	M 272.979	06.06 -	ALT		6 PK 2404
----------	--------	-----------	---------	-----	--	-----------

#### 413 CDI (906.653, 906.655, 906.657)

2148 ccm	95 kW	OM 646.986	06.06 -	ALT		6 PK 2215
----------	-------	------------	---------	-----	--	-----------

#### 416 CDI (906.653, 906.655, 906.657)

2143 ccm	120 kW	OM 651.957	03.09 -	ALT		6 PK 2215
----------	--------	------------	---------	-----	--	-----------

#### 419 CDI (906.653, 906.655, 906.657)

2987 ccm	140 kW	OM 642.992	03.09 -	ALT	- ENG-PTO	7 PK 2035
----------	--------	------------	---------	-----	-----------	-----------

### SPRINTER 4,6-t Pritsche/Fahrgestell (906)

#### 424 (906.153, 906.155, 906.253, 906.255)

3498 ccm	190 kW	M 272.979	06.06 -	ALT	MTR-CODE: 272979	6 PK 2404
----------	--------	-----------	---------	-----	------------------	-----------

#### 413 CDI (906.153, 906.155, 906.253, 906.255)

2148 ccm	95 kW	OM 646.986	06.06 -	ALT	MTR-CODE: 651956	6 PK 2215
----------	-------	------------	---------	-----	------------------	-----------

#### 415 CDI (906.153, 906.155, 906.253, 906.255)

2148 ccm	110 kW	OM 646.989;OM 646.990	06.06 -	ALT	MTR-CODE: 646990; - ENG-PTO	6 PK 2260
				ALT	MTR-CODE: 646990; + ENG-PTO	6 PK 2285

#### 416 CDI (906.153, 906.155, 906.253, 906.255)

2143 ccm	120 kW	OM 651.957	03.09 -	ALT	MTR-CODE: 651957	6 PK 2215
----------	--------	------------	---------	-----	------------------	-----------

#### 418 CDI (906.153, 906.155, 906.253, 906.255)

2987 ccm	135 kW	OM 642.896;OM 642.992;OM 642.993	06.06 -	ALT	MTR-CODE: 642896; - ENG-PTO	7 PK 2035
----------	--------	----------------------------------	---------	-----	-----------------------------	-----------

				ALT	MTR-CODE: 642896;642992; - ENG-PTO	7 PK 2035
				ALT	MTR-CODE: 642992; - ENG-PTO	7 PK 2035

#### 419 CDI (906.153, 906.155, 906.253, 906.255)

2987 ccm	140 kW	OM 642.896;OM 642.898;OM 642.992	03.09 -	ALT	MTR-CODE: 642992; - ENG-PTO	7 PK 2035
----------	--------	----------------------------------	---------	-----	-----------------------------	-----------



## MERCEDES-BENZ

### SPRINTER 5-t Kasten (906)

#### 524 (906.653, 906.655, 906.657)

3498 ccm 190 kW M 272.979 06.06 - ALT 6 PK 2404

#### 509 CDI (906.653, 906.655, 906.657)

2148 ccm 65 kW OM 646.984 06.06 - ALT - ENG-PTO 6 PK 2260  
ALT + ENG-PTO 6 PK 2285

#### 510 CDI (906.653, 906.655, 906.657)

2143 ccm 70 kW OM 651.955 03.09 - ALT 6 PK 2215

#### 511 CDI (906.653, 906.655, 906.657)

2148 ccm 80 kW OM 646.985 06.06 - ALT - ENG-PTO 6 PK 2260  
ALT + ENG-PTO 6 PK 2285

#### 513 CDI (906.653, 906.655, 906.657)

2148 ccm 95 kW OM 646.986 06.06 - ALT FROM: 03.09; - ENG-PTO 6 PK 2260  
ALT FROM: 03.09; + ENG-PTO 6 PK 2285

#### 515 CDI (906.653, 906.655, 906.657)

2148 ccm 110 kW OM 646.989;OM 646.990 06.06 - ALT - ENG-PTO 6 PK 2260  
ALT + ENG-PTO 6 PK 2285

#### 516 CDI (906.653, 906.655, 906.657)

2143 ccm 120 kW OM 651.957 03.09 - ALT 6 PK 2215

#### 518 CDI (906.653, 906.655, 906.657)

2987 ccm 135 kW OM 642.896;OM 642.992;OM 642.993 06.06 - ALT - ENG-PTO 7 PK 2035  
FAN OE-NO.: 0019933896 6 EPK 691

#### 519 CDI (906.653, 906.655, 906.657)

2987 ccm 140 kW OM 642.896;OM 642.898;OM 642.992 03.09 - ALT - ENG-PTO 7 PK 2035

### SPRINTER 5-t Pritsche/Fahrgestell (906)

#### 524 (906.153, 906.155, 906.253, 906.255)

3498 ccm 190 kW M 272.979 06.06 - ALT 6 PK 2404

#### 509 CDI (906.153, 906.155, 906.253, 906.255)

2148 ccm 65 kW OM 646.984 06.06 - ALT - ENG-PTO 6 PK 2260  
ALT + ENG-PTO 6 PK 2285

#### 510 CDI (906.153, 906.155, 906.253, 906.255)

2143 ccm 70 kW OM 651.955 03.09 - ALT MTR-CODE: 651955 6 PK 2215

#### 511 CDI (906.153, 906.155, 906.253, 906.255)

2148 ccm 80 kW OM 646.985 06.06 - ALT - ENG-PTO 6 PK 2260  
ALT + ENG-PTO 6 PK 2285

#### 513 CDI (906.135, 906.155, 906.253, 906.255)

2148 ccm 95 kW OM 646.986 06.06 - ALT FROM: 03.09; - ENG-PTO 6 PK 2260  
ALT FROM: 03.09; + ENG-PTO 6 PK 2285

#### 515 CDI (906.153, 906.155, 906.253, 906.255)

2148 ccm 110 kW OM 646.989;OM 646.990 06.06 - ALT - ENG-PTO 6 PK 2260  
ALT + ENG-PTO 6 PK 2285

#### 516 CDI (906.153, 906.155, 906.253, 906.255)

2143 ccm 120 kW OM 651.957 03.09 - ALT MTR-CODE: 651957 6 PK 2215

#### 518 CDI (906.153, 906.155, 906.253, 906.255)

2987 ccm 135 kW OM 642.896;OM 642.992;OM 642.993 06.06 - ALT MTR-CODE: 642896; - ENG-PTO 7 PK 2035  
FAN OE-NO.: 0019933896 6 EPK 691

#### 519 CDI (906.153, 906.155, 906.253, 906.255)

2987 ccm 140 kW OM 642.896;OM 642.898;OM 642.992 03.09 - ALT MTR-CODE: 642992; - ENG-PTO 7 PK 2035

### T1 Bus (601)

#### 208 2.3

2307 ccm 63 kW M 115.955;M 115.972 05.77 - 12.82 ALT AVX 10 x 940

#### 210 2.3

2298 ccm 70 kW M 102.942 07.82 - 01.90 ALT - AC; - PS; + V-PUL 6 PK 1015  
ALT + AC; - PS; + V-PUL 6 PK 1885  
ALT + AC; + PS; + V-PUL 6 PK 1980  
ALT + PS; - AC; + V-PUL 6 PK 1885

#### 210 2.3

2298 ccm 77 kW M 102.945 05.89 - 02.96 ALT FROM: 09.89; - AC; - PS; + V-PUL 6 PK 1015  
ALT FROM: 09.89; + AC; - PS; + V-PUL 6 PK 1885  
ALT FROM: 09.89; + AC; + PS; + V-PUL 6 PK 1980  
ALT FROM: 09.89; + PS; - AC; + V-PUL 6 PK 1885

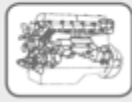

## MERCEDES-BENZ

### T1 Bus (601)

#### 208 D 2.3

2299 ccm	58 kW	OM 601.940	10.88 - 02.96	ALT	UNTIL: 12.89	AVX 10 x 940
				ALT	+ AC; + PS	6 PK 2080
				ALT	FROM MTR-NO: 253307; - AC; - PS	6 PK 995
				ALT	FROM MTR-NO: 253307; + AC; - PS	6 PK 2020
				ALT	FROM MTR-NO: 253307; + PS; - AC	6 PK 1980
				ALT	UNTIL MTR-NO: 253306; - AC; - PS	6 PK 1015
				ALT	UNTIL MTR-NO: 253306; + AC; - PS	6 PK 2030
				ALT	UNTIL MTR-NO: 253306; + PS; - AC	6 PK 2000

#### 208 D 2.3

2299 ccm	60 kW	OM 601.940	10.88 - 02.96	ALT	UNTIL: 12.89	AVX 10 x 940
----------	-------	------------	---------------	-----	--------------	--------------

#### 207 D 2.4

2404 ccm	48 kW	OM 616.917;OM 616.934	05.77 - 12.82	ALT	FROM MTR-NO: 25905917	AVX 13 x 1030
				ALT	UNTIL MTR-NO: 25904917	AVX 10 x 970

#### 207 D 2.4

2376 ccm	53 kW		07.82 - 01.90	ALT	FROM MTR-NO: 25905917	AVX 13 x 1030
----------	-------	--	---------------	-----	-----------------------	---------------

#### 210 D 2.8

2874 ccm	70 kW	OM 602.940	11.88 - 02.96	ALT	FROM: 09.89; + AC; + PS	6 PK 2080
				ALT	FROM: 09.89; FROM MTR-NO: 253307; + AC; - PS	6 PK 2020
				ALT	FROM: 09.89; FROM MTR-NO: 253308; - AC; - PS	6 PK 995
				ALT	FROM: 09.89; FROM MTR-NO: 253308; + PS; - AC	6 PK 1980
				ALT	FROM: 09.89; UNTIL MTR-NO: 253306; + AC; - PS	6 PK 2030
				ALT	FROM: 09.89; UNTIL MTR-NO: 253307; - AC; - PS	6 PK 1015
				ALT	FROM: 09.89; UNTIL MTR-NO: 253307; + PS; - AC	6 PK 2000

### T1 Kasten (601)

#### 210 2.3

2298 ccm	70 kW	M 102.942;M 102.946	07.82 - 02.96	ALT		AVX 10 x 1000
				ALT	- AC; - PS; + V-PUL	6 PK 1015
				ALT	+ AC; - PS; + V-PUL	6 PK 1885
				ALT	+ AC; + PS; + V-PUL	6 PK 1980
				ALT	+ PS; - AC; + V-PUL	6 PK 1885

#### 210 2.3

2298 ccm	77 kW	M 102.945	05.89 - 02.96	ALT	FROM: 09.89; - AC; - PS; + V-PUL	6 PK 1015
				ALT	FROM: 09.89; + AC; - PS; + V-PUL	6 PK 1885
				ALT	FROM: 09.89; + AC; + PS; + V-PUL	6 PK 1980
				ALT	FROM: 09.89; + PS; - AC; + V-PUL	6 PK 1885

#### 208 D 2.3

2299 ccm	58 kW	OM 601.940	11.88 - 02.96	ALT	+ AC; + PS	6 PK 2080
				ALT	FROM MTR-NO: 253307; - AC; - PS	6 PK 995
				ALT	FROM MTR-NO: 253307; + AC; - PS	6 PK 2020
				ALT	FROM MTR-NO: 253307; + PS; - AC	6 PK 1980
				ALT	UNTIL MTR-NO: 253306; - AC; - PS	6 PK 1015
				ALT	UNTIL MTR-NO: 253306; + AC; - PS	6 PK 2030
				ALT	UNTIL MTR-NO: 253306; + PS; - AC	6 PK 2000

#### 208 D 2.3

2299 ccm	60 kW	OM 601.940	10.88 - 02.96	ALT	+ AC; + PS	6 PK 2080
				ALT	FROM MTR-NO: 253307; - AC; - PS	6 PK 995
				ALT	FROM MTR-NO: 253307; + AC; - PS	6 PK 2020
				ALT	FROM MTR-NO: 253307; + PS; - AC	6 PK 1980
				ALT	UNTIL MTR-NO: 253306; - AC; - PS	6 PK 1015
				ALT	UNTIL MTR-NO: 253306; + AC; - PS	6 PK 2030
				ALT	UNTIL MTR-NO: 253306; + PS; - AC	6 PK 2000

#### 207 D 2.4

2399 ccm	53 kW	OM 616.937;OM 616.939	06.82 - 01.90	ALT	FROM: 09.82; UNTIL: 01.89	AVX 13 x 1030
----------	-------	-----------------------	---------------	-----	---------------------------	---------------

#### 210 D 2.8

2874 ccm	70 kW	OM 602.940	10.88 - 02.96	ALT	FROM: 09.89; + AC; + PS	6 PK 2080
				ALT	FROM: 09.89; FROM MTR-NO: 253307; + AC; - PS	6 PK 2020
				ALT	FROM: 09.89; FROM MTR-NO: 253308; - AC; - PS	6 PK 995
				ALT	FROM: 09.89; FROM MTR-NO: 253308; + PS; - AC	6 PK 1980





## MERCEDES-BENZ

### T1 Kasten (601)

#### 210 D 2.8

2874 ccm	70 kW	OM 602.940	10.88 - 02.96	ALT	FROM: 09.89; UNTIL MTR-NO: 253306; + AC; - PS	<b>6 PK 2030</b>
				ALT	FROM: 09.89; UNTIL MTR-NO: 253307; - AC; - PS	<b>6 PK 1015</b>
				ALT	FROM: 09.89; UNTIL MTR-NO: 253307; + PS; - AC	<b>6 PK 2000</b>

### T1 Pritsche/Fahrgestell (601)

#### 210 2.3

2298 ccm	70 kW	M 102.942	04.77 - 10.89	ALT	FROM: 08.81; - AC; - PS; + V-PUL	<b>6 PK 1015</b>
				ALT	FROM: 08.81; + AC; - PS; + V-PUL	<b>6 PK 1885</b>
				ALT	FROM: 08.81; + AC; + PS; + V-PUL	<b>6 PK 1980</b>
				ALT	FROM: 08.81; + PS; - AC; + V-PUL	<b>6 PK 1885</b>

#### 210 2.3

2307 ccm	63 kW	M 115.955	04.77 - 10.89	ALT		<b>AVX 10 x 1000</b>
----------	-------	-----------	---------------	-----	--	----------------------

#### 208 D 2.3

2299 ccm	58 kW	OM 601.940	11.88 - 02.96	ALT	FROM: 09.89; + AC; + PS	<b>6 PK 2080</b>
				ALT	FROM: 09.89; FROM MTR-NO: 253307; - AC; - PS	<b>6 PK 995</b>
				ALT	FROM: 09.89; FROM MTR-NO: 253307; + AC; - PS	<b>6 PK 2020</b>
				ALT	FROM: 09.89; FROM MTR-NO: 253307; + PS; - AC	<b>6 PK 1980</b>
				ALT	FROM: 09.89; UNTIL MTR-NO: 253306; - AC; - PS	<b>6 PK 1015</b>
				ALT	FROM: 09.89; UNTIL MTR-NO: 253306; + AC; - PS	<b>6 PK 2030</b>
				ALT	FROM: 09.89; UNTIL MTR-NO: 253306; + PS; - AC	<b>6 PK 2000</b>

#### 208 D 2.3

2299 ccm	60 kW	OM 601.940	06.89 - 02.96	ALT	UNTIL: 12.89	<b>AVX 10 x 940</b>
				ALT	+ AC; + PS	<b>6 PK 2080</b>
				ALT	FROM MTR-NO: 253307; - AC; - PS	<b>6 PK 995</b>
				ALT	FROM MTR-NO: 253307; + AC; - PS	<b>6 PK 2020</b>
				ALT	FROM MTR-NO: 253307; + PS; - AC	<b>6 PK 1980</b>
				ALT	UNTIL MTR-NO: 253306; - AC; - PS	<b>6 PK 1015</b>
				ALT	UNTIL MTR-NO: 253306; + AC; - PS	<b>6 PK 2030</b>
				ALT	UNTIL MTR-NO: 253306; + PS; - AC	<b>6 PK 2000</b>

#### 207 D 2.4

2399 ccm	53 kW	OM 616.937	12.77 - 10.89	ALT	UNTIL MTR-NO: 025904917;040553934	<b>AVX 10 x 960</b>
----------	-------	------------	---------------	-----	-----------------------------------	---------------------

#### 207 D 2.4

2404 ccm	48 kW	OM 616.917	04.77 - 12.82	ALT	FROM MTR-NO: 25905917	<b>AVX 13 x 1030</b>
				ALT	UNTIL MTR-NO: 25904917	<b>AVX 10 x 970</b>

#### 210 D 2.9

2874 ccm	70 kW	OM 602.940	11.88 - 02.96	ALT	FROM: 09.89; + AC; + PS	<b>6 PK 2080</b>
				ALT	FROM: 09.89; FROM MTR-NO: 253307; + AC; - PS	<b>6 PK 2020</b>
				ALT	FROM: 09.89; FROM MTR-NO: 253308; - AC; - PS	<b>6 PK 995</b>
				ALT	FROM: 09.89; FROM MTR-NO: 253308; + PS; - AC	<b>6 PK 1980</b>
				ALT	FROM: 09.89; UNTIL MTR-NO: 253306; + AC; - PS	<b>6 PK 2030</b>
				ALT	FROM: 09.89; UNTIL MTR-NO: 253307; - AC; - PS	<b>6 PK 1015</b>
				ALT	FROM: 09.89; UNTIL MTR-NO: 253307; + PS; - AC	<b>6 PK 2000</b>

### T1 Bus (602)

#### 308 D 2.3

2299 ccm	58 kW	OM 601.940	05.90 - 02.96	ALT	+ AC; + PS	<b>6 PK 2080</b>
				ALT	FROM MTR-NO: 253307; - AC; - PS	<b>6 PK 995</b>
				ALT	FROM MTR-NO: 253307; + AC; - PS	<b>6 PK 2020</b>
				ALT	FROM MTR-NO: 253307; + PS; - AC	<b>6 PK 1980</b>
				ALT	UNTIL MTR-NO: 253306; - AC; - PS	<b>6 PK 1015</b>
				ALT	UNTIL MTR-NO: 253306; + AC; - PS	<b>6 PK 2030</b>
				ALT	UNTIL MTR-NO: 253306; + PS; - AC	<b>6 PK 2000</b>

#### 308 D 2.3

2299 ccm	60 kW	OM 601.940	06.89 - 02.96	ALT	UNTIL: 12.89	<b>AVX 10 x 940</b>
				ALT	+ AC; + PS	<b>6 PK 2080</b>



## MERCEDES-BENZ

### T1 Bus (602)

#### 308 D 2.3

2299 ccm	60 kW	OM 601.940	06.89 - 02.96	ALT	FROM MTR-NO: 253307; - AC; - PS	6 PK 995
				ALT	FROM MTR-NO: 253307; + AC; - PS	6 PK 2020
				ALT	FROM MTR-NO: 253307; + PS; - AC	6 PK 1980
				ALT	UNTIL MTR-NO: 253306; - AC; - PS	6 PK 1015
				ALT	UNTIL MTR-NO: 253306; + AC; - PS	6 PK 2030
				ALT	UNTIL MTR-NO: 253306; + PS; - AC	6 PK 2000

#### 310 D 2.9

2874 ccm	70 kW	OM 602.940	06.89 - 02.96	ALT	+ AC; + PS	6 PK 2080
				ALT	FROM MTR-NO: 253307; + AC; - PS	6 PK 2020
				ALT	FROM MTR-NO: 253308; - AC; - PS	6 PK 995
				ALT	FROM MTR-NO: 253308; + PS; - AC	6 PK 1980
				ALT	UNTIL MTR-NO: 253306; + AC; - PS	6 PK 2030
				ALT	UNTIL MTR-NO: 253307; - AC; - PS	6 PK 1015
				ALT	UNTIL MTR-NO: 253307; + PS; - AC	6 PK 2000

### T1 Kasten (602)

#### 308 D 2.3

2299 ccm	58 kW	OM 601.940	11.88 - 02.96	ALT	UNTIL: 12.89	AVX 10 x 940
				ALT	+ AC; + PS	6 PK 2080
				ALT	FROM MTR-NO: 253307; - AC; - PS	6 PK 995
				ALT	FROM MTR-NO: 253307; + AC; - PS	6 PK 2020
				ALT	FROM MTR-NO: 253307; + PS; - AC	6 PK 1980
				ALT	UNTIL MTR-NO: 253306; - AC; - PS	6 PK 1015
				ALT	UNTIL MTR-NO: 253306; + AC; - PS	6 PK 2030
				ALT	UNTIL MTR-NO: 253306; + PS; - AC	6 PK 2000

#### 308 D 2.3

2299 ccm	60 kW	OM 601.940	06.89 - 02.96	ALT	+ AC; + PS	6 PK 2080
				ALT	FROM MTR-NO: 253307; - AC; - PS	6 PK 995
				ALT	FROM MTR-NO: 253307; + AC; - PS	6 PK 2020
				ALT	FROM MTR-NO: 253307; + PS; - AC	6 PK 1980
				ALT	UNTIL MTR-NO: 253306; - AC; - PS	6 PK 1015
				ALT	UNTIL MTR-NO: 253306; + AC; - PS	6 PK 2030
				ALT	UNTIL MTR-NO: 253306; + PS; - AC	6 PK 2000

#### 307 D 2.4

2399 ccm	53 kW	OM 616.937;OM 616.939	10.82 - 01.90	ALT	FROM MTR-NO: 025905917;040553934	AVX 13 x 1030
				ALT	UNTIL MTR-NO: 025904917;040553934	AVX 10 x 960

#### 310 D 2.9

2874 ccm	70 kW	OM 602.940	06.89 - 02.96	ALT	+ AC; + PS	6 PK 2080
				ALT	FROM MTR-NO: 253307; + AC; - PS	6 PK 2020
				ALT	FROM MTR-NO: 253308; - AC; - PS	6 PK 995
				ALT	FROM MTR-NO: 253308; + PS; - AC	6 PK 1980
				ALT	UNTIL MTR-NO: 253306; + AC; - PS	6 PK 2030
				ALT	UNTIL MTR-NO: 253307; - AC; - PS	6 PK 1015
				ALT	UNTIL MTR-NO: 253307; + PS; - AC	6 PK 2000

### T1 Pritsche/Fahrgestell (602)

#### 307 D 2.4

2399 ccm	48 kW	OM 616.937	04.77 - 01.83	ALT	FROM: 05.77; UNTIL: 12.78; UNTIL MTR-NO: 000069; + FA	AVX 10 x 970
				ALT	FROM: 05.77; UNTIL: 12.78; UNTIL MTR-NO: 040552; + MAN-TM	AVX 10 x 970

#### 307 D 2.4

2399 ccm	53 kW	OM 616.937;OM 616.939	06.82 - 01.90	ALT	FROM: 09.82; UNTIL: 01.89	AVX 13 x 1030
----------	-------	-----------------------	---------------	-----	---------------------------	---------------

#### 308 D 2.3

2299 ccm	58 kW	OM 601.940	06.89 - 02.96	ALT	UNTIL: 12.89	AVX 10 x 940
				ALT	+ AC; + PS	6 PK 2080
				ALT	FROM MTR-NO: 253307; - AC; - PS	6 PK 995
				ALT	FROM MTR-NO: 253307; + AC; - PS	6 PK 2020
				ALT	FROM MTR-NO: 253307; + PS; - AC	6 PK 1980
				ALT	UNTIL MTR-NO: 253306; - AC; - PS	6 PK 1015
				ALT	UNTIL MTR-NO: 253306; + AC; - PS	6 PK 2030
				ALT	UNTIL MTR-NO: 253306; + PS; - AC	6 PK 2000

#### 308 D 2.3

2299 ccm	60 kW	OM 601.940	06.89 - 02.96	ALT	+ AC; + PS	6 PK 2080
				ALT	FROM MTR-NO: 253307; - AC; - PS	6 PK 995
				ALT	FROM MTR-NO: 253307; + AC; - PS	6 PK 2020
				ALT	FROM MTR-NO: 253307; + PS; - AC	6 PK 1980



## MERCEDES-BENZ

### T1 Pritsche/Fahrgestell (602)

#### 308 D 2.3

2299 ccm	60 kW	OM 601.940	06.89 - 02.96	ALT	UNTIL MTR-NO: 253306; - AC; - PS	6 PK 1015
				ALT	UNTIL MTR-NO: 253306; + AC; - PS	6 PK 2030
				ALT	UNTIL MTR-NO: 253306; + PS; - AC	6 PK 2000

#### 310 D 2.9

2874 ccm	70 kW	OM 602.940	06.89 - 02.96	ALT	+ AC; + PS	6 PK 2080
				ALT	FROM MTR-NO: 253307; + AC; - PS	6 PK 2020
				ALT	FROM MTR-NO: 253308; - AC; - PS	6 PK 995
				ALT	FROM MTR-NO: 253308; + PS; - AC	6 PK 1980
				ALT	UNTIL MTR-NO: 253306; + AC; - PS	6 PK 2030
				ALT	UNTIL MTR-NO: 253307; - AC; - PS	6 PK 1015
				ALT	UNTIL MTR-NO: 253307; + PS; - AC	6 PK 2000

### T1/TN Pritsche/Fahrgestell

#### 410 (611.017, 611.018)

2298 ccm	70 kW	M 102.942	08.82 - 06.95	AC-C	MOD: 410	AVX 13 x 875
----------	-------	-----------	---------------	------	----------	--------------

#### 410 (611.017, 611.018)

2298 ccm	77 kW	M 102.945	08.82 - 06.95	AC-C	MOD: 410	AVX 13 x 875
----------	-------	-----------	---------------	------	----------	--------------

#### 407 D (611.317, 611.318)

2398 ccm	53 kW	OM 616.913;OM 616.939	07.81 - 01.89	ALT	MTR-CODE: OM 616.913; MOD: 407 D	AVX 13 x 1025
				PS	MTR-CODE: OM 616.913; MOD: 407 D	AVX 13 x 900

#### 408 D (611.317, 611.318)

2299 ccm	58 kW	OM 601.940	11.88 - 06.95	ALT	FROM MTR-NO: 253307; MOD: 408D; + AC; - PS	6 PK 2030
				ALT	FROM MTR-NO: 253307; MOD: 408D; + PS; - AC	6 PK 1980
				ALT	FROM MTR-NO: 353307; MOD: 408D; - PS	6 PK 995
				ALT	OE-NO.: 0089973792; MOD: 408D; + AC; + PS	6 PK 2080
				ALT	OE-NO.: 0089976392; MOD: 408D; + AC; + PS	6 PK 2030
				ALT	UNTIL MTR-NO: 253306; MOD: 408D; + AC; - PS	6 PK 2030
				ALT	UNTIL MTR-NO: 253306; MOD: 408D; + PS; - AC	6 PK 2000

#### 408 D (611.317, 611.318)

2299 ccm	60 kW	OM 601.940	11.88 - 06.95	ALT	FROM MTR-NO: 253307; MOD: 408D; + AC; - PS	6 PK 2030
				ALT	FROM MTR-NO: 253307; MOD: 408D; + PS; - AC	6 PK 1980
				ALT	FROM MTR-NO: 353307; MOD: 408D; - PS	6 PK 995
				ALT	OE-NO.: 0089973792; MOD: 408D; + AC; + PS	6 PK 2080
				ALT	OE-NO.: 0089976392; MOD: 408D; + AC; + PS	6 PK 2030
				ALT	UNTIL MTR-NO: 253306; MOD: 408D; + AC; - PS	6 PK 2030
				ALT	UNTIL MTR-NO: 253306; MOD: 408D; + PS; - AC	6 PK 2000

#### 409 D (611.417, 611.418)

2998 ccm	65 kW	OM 617.913	04.82 - 01.89	ALT	MOD: 409 D	AVX 13 x 1000
----------	-------	------------	---------------	-----	------------	---------------

#### 410 D (611.417, 611.418)

2874 ccm	70 kW	OM 602.940	11.88 - 06.95	ALT	FROM MTR-NO: 253308; MOD: 410D; + AC; - PS	6 PK 2030
				ALT	FROM MTR-NO: 253308; UNTIL MTR-NO: 340125; MOD: 410D; - AC; - PS	6 PK 995
				ALT	FROM MTR-NO: 253308; UNTIL MTR-NO: 340125; MOD: 410D; + PS; - AC	6 PK 1980
				ALT	FROM MTR-NO: 340126; MOD: 410D; + AC; - PS	6 PK 2050
				ALT	FROM MTR-NO: 340126; MOD: 410D; + AC; + PS	6 PK 2100
				ALT	FROM MTR-NO: 340126; MOD: 410D; + PS; - AC	6 PK 2040
				ALT	UNTIL MTR-NO: 253307; MOD: 410D; + AC; - PS	6 PK 2030
				ALT	UNTIL MTR-NO: 253307; MOD: 410D; + PS; - AC	6 PK 2000
				ALT	UNTIL MTR-NO: 340125; MOD: 410D; + AC; - PS	6 PK 2030
				ALT	UNTIL MTR-NO: 340125; MOD: 410D; + AC; + PS	6 PK 2080

#### 410 D (611.417, 611.418)

2874 ccm	72 kW	OM 602.940	11.88 - 06.95	ALT	FROM MTR-NO: 253308; MOD: 410D; + AC; - PS	6 PK 2030
----------	-------	------------	---------------	-----	--	-----------



## MERCEDES-BENZ

### T1/TN Pritsche/Fahrgestell

#### 410 D (611.417, 611.418)

2874 ccm	72 kW	OM 602.940	11.88 - 06.95	ALT	FROM MTR-NO: 253308; UNTIL MTR-NO: 340125; MOD: 410D; - AC; - PS	6 PK 995
				ALT	FROM MTR-NO: 253308; UNTIL MTR-NO: 340125; MOD: 410D; + PS; - AC	6 PK 1980
				ALT	FROM MTR-NO: 340126; MOD: 410D; + AC; - PS	6 PK 2050
				ALT	FROM MTR-NO: 340126; MOD: 410D; + AC; + PS	6 PK 2100
				ALT	FROM MTR-NO: 340126; MOD: 410D; + PS; - AC	6 PK 2040
				ALT	UNTIL MTR-NO: 253307; MOD: 410D; + AC; - PS	6 PK 2030
				ALT	UNTIL MTR-NO: 253307; MOD: 410D; + PS; - AC	6 PK 2000
				ALT	UNTIL MTR-NO: 340125; MOD: 410D; + AC; - PS	6 PK 2030
				ALT	UNTIL MTR-NO: 340125; MOD: 410D; + AC; + PS	6 PK 2080

### VARIO Pritsche/Fahrgestell

#### 512 D (667.321, 667.322, 667.323)

2874 ccm	90 kW	OM 602.984	09.96 -	ALT	MOD: 512D; - AC	6 PK 2050
----------	-------	------------	---------	-----	-----------------	-----------

#### 612 D (668.321, 668.322, 668.323)

2874 ccm	90 kW	OM 602.984; OM 602.985	09.96 -	ALT	MTR-CODE: OM602.984; MOD: 612D; - AC	6 PK 2050
				ALT	MTR-CODE: OM602.984; MOD: 612D; - AC	6 PK 2245

#### 812 D (670.321, 670.322, 670.323, 670.324)

2874 ccm	90 kW	OM 602.984; OM 602.985	09.96 -	ALT	MTR-CODE: OM602.984; MOD: 812D; - AC	6 PK 2050
				ALT	MTR-CODE: OM602.984; MOD: 812D; - AC	6 PK 2245

### VARIO Kipper

#### 612 D (668.331, 668.332)

2874 ccm	90 kW	OM 602.984; OM 602.985	09.96 -	ALT	MTR-CODE: OM602.984; MOD: 612D; - AC	6 PK 2050
				ALT	MTR-CODE: OM602.984; MOD: 612D; - AC	6 PK 2245

#### 812 D (670.331, 670.332)

2874 ccm	90 kW	OM 602.984; OM 602.985	09.96 -	ALT	MTR-CODE: OM602.984; MOD: 812D; - AC	6 PK 2050
				ALT	MTR-CODE: OM602.984; MOD: 812D; - AC	6 PK 2245

## MITSUBISHI

### L 300 Bus (P0\_W, P1\_W, P2\_W)

#### 1.6 (P02V, P12V)

1598 ccm	51 kW	4G32	11.86 -	ALT		AVX 10 x 935
				BAL		ZRK 1388
				CAM		ZRK 1258
				BAL		KT 1386
				CAM		KT 1174

#### 2.0 (P13V, P03W, P13T)

1997 ccm	64 kW	G63B	11.86 -	BAL	FROM: 05.92	ZRK 1459
				BAL	UNTIL: 04.92	ZRK 1388
				CAM	FROM: 05.92	ZRK 1174
				CAM	UNTIL: 04.92	ZRK 1259
				BAL	FROM: 05.92	KT 1387
				CAM	FROM: 05.87; UNTIL: 04.92	KT 1321
				CAM	UNTIL: 04.92	KT 1361

#### 2.0 4WD (P13V, P23V, P23W, P03V, P13T)

1997 ccm	65 kW	4G63 (SOHC 8V)	12.86 -	ALT	FROM: 06.94	4 PK 985
				PS	FROM: 06.94	4 PK 1060
				BAL	FROM: 05.92	ZRK 1459
				BAL	UNTIL: 04.92	ZRK 1388
				CAM	FROM: 05.92	ZRK 1174
				CAM	UNTIL: 04.92	ZRK 1259
				BAL	FROM: 05.92	KT 1387
				CAM	FROM: 05.87; UNTIL: 04.92	KT 1321
				CAM	UNTIL: 04.92	KT 1361

#### 2.0 (P13T, P03W, P03V, P13V)

1997 ccm	66 kW	4G63 (SOHC 8V)	11.86 -	BAL	FROM: 05.92	ZRK 1459
				BAL	UNTIL: 04.92	ZRK 1388
				CAM	FROM: 05.92	ZRK 1174
				CAM	UNTIL: 04.92	ZRK 1259



## MITSUBISHI

### L 300 Bus (P0\_W, P1\_W, P2\_W)

#### 2.0 (P13T, P03W, P03V, P13V)

1997 ccm	66 kW	4G63 (SOHC 8V)	11.86 -	BAL	FROM: 05.92	KT 1387
				CAM	FROM: 05.87; UNTIL: 04.92	KT 1321
				CAM	UNTIL: 04.92	KT 1361

#### 2.0 4WD (P13V, P23W, P03V, P13T)

1997 ccm	66 kW	4G63 (SOHC 8V)	11.86 -	BAL	FROM: 05.92	ZRK 1459
				BAL	UNTIL: 04.92	ZRK 1388
				CAM	FROM: 05.92	ZRK 1174
				CAM	UNTIL: 04.92	ZRK 1259
				BAL	FROM: 05.92	KT 1387
				CAM	FROM: 05.87; UNTIL: 04.92	KT 1321
				CAM	UNTIL: 04.92	KT 1361

#### 2.0 i (P13V, P00W, P03V, P03W, P13T)

1997 ccm	83 kW	4G63 (DOHC 16V)	07.96 -	BAL		ZRK 1459
				CAM		ZRK 1176
				BAL	MTR-CODE: 4G63;G63B	KT 1387
				CAM	MTR-CODE: 4G63;G63B	KT 1272

#### 2.4 4WD (P24W, P24V)

2351 ccm	80 kW	G64B	11.86 -	BAL		ZRK 1388
				CAM		ZRK 1285
				CAM		KT 1276
				CAM	FROM: 05.87	KT 1321

#### 2.4 (P04W, P14V, P04V)

2351 ccm	82 kW	4G64 (12V)	11.90 -	BAL	FROM: 05.92	ZRK 1459
				BAL	UNTIL: 04.92	ZRK 1388
				CAM	FROM: 05.92	ZRK 1177
				CAM	UNTIL: 04.92	ZRK 1285
				BAL	FROM: 05.92	KT 1387
				CAM	UNTIL: 04.92	KT 1276
				CAM	UNTIL: 04.92	KT 1321

#### 2.4 4WD (P24W, P24V)

2351 ccm	82 kW	4G64 (12V)	11.90 -	BAL	FROM: 05.92	ZRK 1459
				BAL	UNTIL: 04.92	ZRK 1388
				CAM	FROM: 05.92	ZRK 1177
				CAM	UNTIL: 04.92	ZRK 1285
				BAL	FROM: 05.92	KT 1387
				CAM	UNTIL: 04.92	KT 1276
				CAM	UNTIL: 04.92	KT 1321

#### 2.5 D (P25V, P05W, P05V, P15V, P15T)

2477 ccm	51 kW	4D56 (8V)	11.86 -	BAL	FROM: 06.93	ZRK 1202
				BAL	UNTIL: 05.93	ZRK 1277
				CAM	FROM: 06.93	ZRK 1522
				CAM	UNTIL: 05.93	ZRK 1260
				BAL	FROM: 06.93	KT 1391
				BAL	UNTIL: 05.93	KT 1157
				CAM	FROM: 06.93	KT 1488
				CAM	UNTIL: 05.93	KT 1143

#### 2.5 TD 4WD (P25W, P25V)

2477 ccm	64 kW	4D56 T	11.88 -	BAL	FROM: 06.93	ZRK 1202
				BAL	UNTIL: 05.93	ZRK 1277
				CAM	FROM: 06.93	ZRK 1522
				CAM	UNTIL: 05.93	ZRK 1260
				BAL	UNTIL: 05.93	KT 1157
				CAM	UNTIL: 05.93	KT 1143

### L 300 Kasten (P0\_W, P1\_W)

#### 1.6 (P12V, P02V)

1598 ccm	51 kW	4G32	11.86 -	ALT		AVX 10 x 935
				BAL		ZRK 1388
				CAM		ZRK 1258
				BAL		KT 1386
				CAM		KT 1174

#### 2.0 (P03V, P13V)

1997 ccm	64 kW	G63B	11.86 -	ALT	FROM: 06.94	4 PK 985
				PS	FROM: 06.94	4 PK 1060
				BAL	FROM: 05.92	ZRK 1459
				BAL	UNTIL: 04.92	ZRK 1388



## MITSUBISHI

### L 300 Kasten (P0\_W, P1\_W)

#### 2.0 (P03V, P13V)

1997 ccm	64 kW	G63B	11.86 -	CAM	FROM: 05.92	ZRK 1174
				CAM	UNTIL: 04.92	ZRK 1259
				BAL	FROM: 05.92	KT 1387
				CAM	FROM: 05.87; UNTIL: 04.92	KT 1321
				CAM	UNTIL: 04.92	KT 1361

#### 2.0 (P23W, P23V)

1997 ccm	78 kW	4G63 (DOHC 16V)	06.94 -	ALT		4 PK 985
				PS		4 PK 1060

#### 2.0 (P23W, P23V)

1997 ccm	82 kW	4G63 (SOHC 8V)	06.94 -	BAL		ZRK 1459
				CAM		ZRK 1176
				BAL		KT 1387

#### 2.4 4WD (P24V, P24W)

2351 ccm	82 kW	4G64 (8V);G64B	11.86 -	BAL	FROM: 05.92	ZRK 1459
				BAL	UNTIL: 04.92	ZRK 1388
				CAM	FROM: 05.92	ZRK 1177
				CAM	UNTIL: 04.92	ZRK 1285
				BAL	FROM: 05.92	KT 1387
				CAM	UNTIL: 04.92	KT 1276

#### 2.5 D (P05V, P05W, P15V)

2477 ccm	51 kW	4D56 (8V)	11.86 -	BAL	FROM: 06.93	ZRK 1202
				BAL	UNTIL: 05.93	ZRK 1277
				CAM	FROM: 06.93	ZRK 1522
				CAM	UNTIL: 05.93	ZRK 1260
				BAL	FROM: 06.93	KT 1391
				BAL	UNTIL: 05.93	KT 1157
				CAM	FROM: 06.93	KT 1488
				CAM	UNTIL: 05.93	KT 1143

### L 300 Pritsche/Fahrgestell (P1\_T)

#### 2.0 (P13T)

1997 ccm	85 kW	4G63 (DOHC 16V)	07.94 - 04.00	AC-C		4 PK 985
				ALT		4 PK 985
				PS		4 PK 1060
				BAL		ZRK 1459
				CAM		ZRK 1176
				BAL		KT 1387
				CAM		KT 1272

#### 2.5 TD (P15T)

2477 ccm	64 kW	4D56 T	11.94 - 04.00	PS		4 PK 1125
				BAL		ZRK 1202
				CAM		ZRK 1522
				BAL		KT 1391
				CAM		KT 1488

### L 400 / SPACE GEAR Bus (PD\_W, PC\_W, PA\_V, PB\_V)

#### 2.0 16V (PA3V/W, PB3V)

1997 ccm	85 kW	4G63 (DOHC 16V)	05.95 - 05.00	AC-C		4 PK 940
				ALT		4 PK 985
				PS		4 PK 1060
				BAL		ZRK 1459
				CAM		ZRK 1176
				BAL		KT 1387
				CAM		KT 1272

#### 2.4 i 4WD (PD4V/W)

2351 ccm	97 kW	4G64 (SOHC 16V)	05.95 - 05.00	AC-C		4 PK 940
				ALT		4 PK 985
				PS		4 PK 1060
				BAL		ZRK 1459
				CAM		ZRK 1180
				BAL		KT 1387
				CAM		KT 1273

#### 2500 TD

2477 ccm	64 kW	4D56 T	05.95 - 06.05	BAL		ZRK 1202
				CAM		ZRK 1522

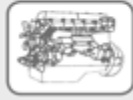

## MITSUBISHI

### L 400 / SPACE GEAR Bus (PD\_W, PC\_W, PA\_V, PB\_V)

#### 2.5 TD (PA5V/W, PB5V)

2477 ccm	73 kW	4D56 TD	05.95 - 05.00	ALT PS BAL CAM		AVX 10 x 1100 4 PK 1080 ZRK 1202 ZRK 1522
----------	-------	---------	---------------	-------------------------	--	--

#### 2.5 TD 4WD (PD5V/W)

2477 ccm	73 kW	4D56 TD	05.95 - 05.00	ALT PS BAL CAM		AVX 10 x 1100 4 PK 1080 ZRK 1202 ZRK 1522
----------	-------	---------	---------------	-------------------------	--	--

### L 400 Kasten (PD\_W, PC\_W, PB\_V, PA\_W, PA\_V)

#### 2500 TD (PD5W, PD5V, PA5W, PA5V)

2477 ccm	64 kW	4D56 T	09.96 - 06.05	BAL CAM		ZRK 1202 ZRK 1522
----------	-------	--------	---------------	------------	--	----------------------

## NISSAN

### CABSTAR E

#### 75.28

2283 ccm	55 kW	LD23	10.98 -	ALT ALT	MOD: 75.28; REQ: 2 MOD: 75.28; REQ: 2	AVX 13 x 1100 AVX 13 x 1100 TM
----------	-------	------	---------	------------	--	-----------------------------------

### INTERSTAR Bus (X70)

#### dCi 80

1870 ccm	60 kW	F9Q 772	07.02 -	ALT ALT CAM CAM CAM	- AC + AC	5 PK 1125 6 PK 1795 ZRK 1067 KT 1434 KT 1434 W1
----------	-------	---------	---------	---------------------------------	--------------	---

#### dCi 90

2188 ccm	66 kW	G9T 722	07.02 -	ALT ALT CAM CAM	- AC + AC	6 PK 1145 6 PK 1795 ZRK 1462 KT 1392
----------	-------	---------	---------	--------------------------	--------------	---

#### dCi 100

2463 ccm	73 kW	G9U 720	11.03 -	CAM CAM		ZRK 1462 KT 1392
----------	-------	---------	---------	------------	--	---------------------

#### dCi 120

2463 ccm	84 kW	G9U 720	07.02 -	ALT ALT CAM CAM	- AC + AC	6 PK 1145 6 PK 1795 ZRK 1462 KT 1392
----------	-------	---------	---------	--------------------------	--------------	---

#### dCi 120

2464 ccm	88 kW	G9U 650	09.06 -	ALT ALT ALT	- AC; - ENG-PTO - AC; + ENG-PTO + AC	7 PK 1110 7 PK 1793 7 PK 1793
----------	-------	---------	---------	-------------------	--	-------------------------------------

#### dCi 150

2464 ccm	107 kW	G9U 632	09.06 -	ALT ALT ALT	- AC; - ENG-PTO - AC; + ENG-PTO + AC	7 PK 1110 7 PK 1793 7 PK 1793
----------	--------	---------	---------	-------------------	--	-------------------------------------

### INTERSTAR Kasten (X70)

#### dCi 80

1870 ccm	60 kW	F9Q 772	07.02 -	ALT ALT CAM CAM CAM	- AC + AC	5 PK 1125 6 PK 1795 ZRK 1067 KT 1434 KT 1434 W1
----------	-------	---------	---------	---------------------------------	--------------	---

#### dCi 90

2188 ccm	66 kW	G9T 722	07.02 -	ALT ALT CAM CAM	- AC + AC	6 PK 1145 6 PK 1795 ZRK 1462 KT 1392
----------	-------	---------	---------	--------------------------	--------------	---

#### dCi 100

2463 ccm	73 kW	G9U 720	11.03 -	ALT	FROM: 04.06; MTR-CODE: G9U; - AC; - ENG-PTO	7 PK 1110
----------	-------	---------	---------	-----	---	-----------



## NISSAN

### INTERSTAR Kasten (X70)

#### dCi 100

2463 ccm	73 kW	G9U 720	11.03 -	ALT	FROM: 04.06; MTR-CODE: G9U; - AC; + ENG-PTO	7 PK 1793
				ALT	FROM: 04.06; MTR-CODE: G9U; + AC	7 PK 1793
				ALT	MTR-CODE: G9U; - AC	6 PK 1145
				ALT	MTR-CODE: G9U; + AC	6 PK 1795
				CAM		ZRK 1462
				CAM		KT 1392

#### dCi 100

2464 ccm	74 kW	G9U 720	04.06 -	ALT	MTR-CODE: G9U; - AC	6 PK 1145
				ALT	MTR-CODE: G9U; - AC; - ENG-PTO	7 PK 1110
				ALT	MTR-CODE: G9U; - AC; + ENG-PTO	7 PK 1793
				ALT	MTR-CODE: G9U; + AC	6 PK 1795
				ALT	MTR-CODE: G9U; + AC	7 PK 1793

#### dCi 120

2463 ccm	84 kW	G9U 720	07.02 -	ALT	- AC	6 PK 1145
				ALT	+ AC	6 PK 1795
				CAM		ZRK 1462
				CAM		KT 1392

#### dCi 120

2464 ccm	88 kW	G9U 650	09.06 -	ALT	FROM: 04.06; - AC; - ENG-PTO	7 PK 1110
				ALT	FROM: 04.06; - AC; + ENG-PTO	7 PK 1793
				ALT	FROM: 04.06; + AC	7 PK 1793

#### dCi 150

2464 ccm	107 kW	G9U 632	09.06 -	ALT	- AC; - ENG-PTO	7 PK 1110
				ALT	- AC; + ENG-PTO	7 PK 1793
				ALT	+ AC	7 PK 1793

### INTERSTAR Pritsche/Fahrgestell

#### dCi 100

2463 ccm	73 kW	G9U 720	02.04 -	ALT	FROM: 04.06; MTR-CODE: G9U; - AC; - ENG-PTO	7 PK 1110
				ALT	FROM: 04.06; MTR-CODE: G9U; - AC; + ENG-PTO	7 PK 1793
				ALT	FROM: 04.06; MTR-CODE: G9U; + AC	7 PK 1793
				ALT	MTR-CODE: G9U; - AC	6 PK 1145
				ALT	MTR-CODE: G9U; + AC	6 PK 1795
				CAM		ZRK 1462
				CAM		KT 1392

#### dCi 120

2463 ccm	84 kW	G9U 720	08.03 -	ALT	- AC	6 PK 1145
				ALT	+ AC	6 PK 1795

#### dCi 120

2464 ccm	88 kW	G9U 650	08.06 -	ALT	- AC; - ENG-PTO	7 PK 1110
				ALT	- AC; + ENG-PTO	7 PK 1793
				ALT	+ AC	7 PK 1793

#### dCi 150

2464 ccm	107 kW	G9U 632	08.06 -	ALT	- AC; - ENG-PTO	7 PK 1110
				ALT	- AC; + ENG-PTO	7 PK 1793
				ALT	+ AC	7 PK 1793

### PRIMASTAR Bus (X83)

#### 2.0

1998 ccm	88 kW	F4R 720;F4R 722	03.01 -	ALT	FROM: 07.02; - AC	5 PK 1125
				ALT	FROM: 07.02; + AC	6 PK 1795
				CAM		ZRK 1475

#### dCi 80

1870 ccm	60 kW	F9Q 762	03.01 -	ALT	FROM: 07.02; - AC	5 PK 1125
				ALT	FROM: 07.02; + AC	6 PK 1795
				CAM		ZRK 1067
				CAM		KT 1434
				CAM		KT 1434 W1

#### dCi 100

1870 ccm	74 kW	F9Q 760	03.01 -	ALT	FROM: 07.02; - AC	5 PK 1125
				ALT	FROM: 07.02; + AC	6 PK 1795
				CAM		ZRK 1067
				CAM		KT 1434
				CAM		KT 1434 W1



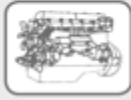

## NISSAN

### PRIMASTAR Bus (X83)

#### dCi 120

1995 ccm 84 kW M9R 780 09.06 - ALT + AC 7 PK 1970

#### dCi 140

2463 ccm 99 kW G9U 730 07.03 - CAM ZRK 1462  
CAM KT 1392

### PRIMASTAR Kasten (X83)

#### 2.0

1998 ccm 88 kW F4R 720 02.03 - ALT - AC 5 PK 1125  
ALT + AC 6 PK 1795  
CAM ZRK 1475

#### dCi 80

1870 ccm 60 kW F9Q 762 09.02 - ALT - AC 5 PK 1125  
ALT + AC 6 PK 1795  
CAM ZRK 1067  
CAM KT 1434  
CAM KT 1434 W1

#### dCi 100

1870 ccm 74 kW F9Q 760 09.02 - ALT - AC 5 PK 1125  
ALT + AC 6 PK 1795  
CAM ZRK 1067  
CAM KT 1434  
CAM KT 1434 W1

#### dCi 120

1995 ccm 84 kW M9R 780 09.06 - ALT + AC 7 PK 1970

#### dCi 140

2463 ccm 99 kW G9U 730 07.03 - CAM ZRK 1462  
CAM KT 1392

### URVAN Kasten (E23)

#### 2.0

1982 ccm 55 kW H20 07.81 - 11.82 ALT AVX 10 x 950

#### 2.3 D

2289 ccm 50 kW SD23 11.82 - 05.87 AC-C UNTIL: 01.87; MOD: E23 AVX 13 x 1500

### URVAN Bus (E24)

#### 2.4 i

2389 ccm 74 kW Z24i 05.89 - 09.93 AC-C AVX 13 x 850  
ALT AVX 10 x 950

### VANETTE Bus (C22)

#### 2.0 D (ULC22)

1952 ccm 47 kW LD20 10.86 - 12.95 CAM ZRK 1287  
CAM KT 1168

#### 2.0 D (ULC22)

1952 ccm 49 kW LD20 10.86 - 12.95 CAM ZRK 1287  
CAM KT 1168

### VANETTE Kasten (C22)

#### 2.0 D

1952 ccm 49 kW LD20II 07.91 - 01.95 ALT UNTIL: 01.92 17 x 1000  
CAM ZRK 1287  
CAM KT 1168

### VANETTE CARGO Bus (HC 23)

#### 1.6 i

1597 ccm 72 kW GA16DE 01.96 - AC-C MOD: Cargo 4 PK 835  
ALT MOD: Cargo 4 PK 913  
PS MOD: Cargo 4 PK 813

#### 2.0 D

1952 ccm 49 kW LD20 01.96 - CAM ZRK 1287  
CAM KT 1168

#### 2.3 D

2283 ccm 55 kW LD23 01.96 - PS AVX 13 x 850  
CAM ZRK 1189  
CAM UNTIL: 11.01 KT 1472



## NISSAN

### VANETTE CARGO Kasten (HC 23)

<b>1.6 i</b>						
1597 ccm	71 kW	GA16DE	01.95 -	AC-C ALT PS	MOD: Cargo MOD: Cargo MOD: Cargo	4 PK 835 4 PK 913 4 PK 813
<b>2.0 D</b>						
1952 ccm	49 kW	LD20	01.95 -	CAM CAM		ZRK 1287 KT 1168
<b>2.3 D</b>						
2283 ccm	55 kW	LD23	01.95 -	PS CAM CAM	UNTIL: 11.01	AVX 13 x 850 ZRK 1189 KT 1472

### CABSTAR Pritsche/Fahrgestell (F23, H41, H42)

<b>2.0</b>						
1952 ccm	66 kW	Z20S	07.92 - 05.94	ALT		4 PK 913

## OPEL

### MOVANO Combi (J9)

<b>1.9 DTI</b>						
1870 ccm	59 kW	F9Q 770	09.00 -	ALT CAM CAM CAM		6 PK 1130 ZRK 1067 KT 1434 KT 1434 W1
<b>1.9 DTI</b>						
1870 ccm	60 kW	F9Q 772;F9Q 774	10.01 -	ALT ALT CAM CAM CAM	- AC + AC	5 PK 1125 6 PK 1795 ZRK 1067 KT 1434 KT 1434 W1
<b>2.2 DTI</b>						
2188 ccm	66 kW	G9T 720;G9T 722;G9T 750	09.00 -	ALT ALT ALT ALT CAM CAM	FROM: 11.04; MTR-CODE: G9T750; - AC; - ENG-PTO MTR-CODE: G9T722; - AC MTR-CODE: G9T722; + AC MTR-CODE: G9T750; + AC; + ENG-PTO UNTIL: 11.04; MTR-CODE: G9T750; - AC; - ENG-PTO	7 PK 1105 6 PK 1145 6 PK 1795 7 PK 1793 7 PK 1145 ZRK 1462 KT 1392
<b>2.5 DTI</b>						
2463 ccm	84 kW	G9U 720;G9U 724;G9U 750;G9U 754	10.01 -	ALT ALT ALT ALT CAM CAM	FROM: 10.03; + AC FROM: 10.03; OE-NO.: 9121108;4405275; - AC; - ENG-PTO FROM: 10.03; OE-NO.: 93186955;4416361; - AC; - ENG-PTO FROM: 10.03; OE-NO.: 93195484;4418674; - AC; - ENG-PTO	7 PK 1793 7 PK 1145 7 PK 1105 7 PK 1105 ZRK 1462 KT 1392
<b>2.5 CDTI</b>						
2464 ccm	74 kW	G9U 650	09.07 -	ALT ALT	- AC; - ENG-PTO OE-NO.: 93195485;4418675; + AC; + ENG-PTO	7 PK 1110 7 PK 1793
<b>2.5 CDTI</b>						
2464 ccm	88 kW	G9U 632;G9U 650	08.06 -	ALT ALT CAM CAM	- AC; - ENG-PTO OE-NO.: 93195485;4418675; + AC; + ENG-PTO	7 PK 1110 7 PK 1793 ZRK 1462 KT 1392
<b>2.5 CDTI</b>						
2464 ccm	107 kW	G9U 632;G9U 650	08.06 -	ALT ALT CAM CAM	- AC; - ENG-PTO OE-NO.: 93195485;4418675; + AC; + ENG-PTO	7 PK 1110 7 PK 1793 ZRK 1462 KT 1392
<b>2.5 D</b>						
2499 ccm	59 kW	S8U 770;S8U 772	07.98 -	AC-C ALT ALT	FROM: 11.98 FROM: 11.98; FROM MTR-NO: 3053819 FROM: 11.98; UNTIL MTR-NO: 3053818	5 PK 1200 6 PK 870 6 PK 858



## OPEL

### MOVANO Combi (J9)

#### 2.5 D

2499 ccm	59 kW	S8U 770;S8U 772	07.98 -	CAM		ZRK 1312
				CAM		KT 1229

#### 2.8 DTi

2799 ccm	84 kW	S9W 700;S9W 702	07.98 -	AC-C	FROM: 11.98	5 PK 1200
				ALT	FROM: 11.98; FROM MTR-NO: 3053819	6 PK 850
				ALT	FROM: 11.98; UNTIL MTR-NO: 3053818	6 PK 845
				CAM		ZRK 1332
				CAM		KT 1340

#### 3.0 DTi

2953 ccm	100 kW	ZD3 200;ZD3 202	10.03 -	ALT		7 PK 1920
----------	--------	-----------------	---------	-----	--	-----------

### MOVANO Kasten (F9)

#### 1.9 DTi

1870 ccm	59 kW	F9Q 770	09.00 -	ALT		6 PK 1130
				CAM		ZRK 1069
				CAM		KT 1247
				CAM		KT 1493

#### 1.9 DTi

1870 ccm	60 kW	F9Q 772;F9Q 774	10.01 -	ALT	- AC	5 PK 1125
				ALT	+ AC	6 PK 1795
				CAM		ZRK 1067
				CAM		KT 1434
				CAM		KT 1434 W1

#### 2.2 DTi

2188 ccm	66 kW	G9T 720;G9T 722;G9T 750	09.00 -	ALT	- AC	6 PK 1145
				ALT	+ AC	6 PK 1795
				ALT	FROM: 11.04; MTR-CODE: G9T750; - AC; - ENG-PTO	7 PK 1105
				ALT	MTR-CODE: G9T750; + AC; + ENG-PTO	7 PK 1793
				ALT	UNTIL: 11.04; MTR-CODE: G9T750; - AC; - ENG-PTO	7 PK 1145
				CAM		ZRK 1462
				CAM		KT 1392

#### 2.5 DTi

2463 ccm	73 kW	G9U 754	10.03 -	ALT	+ AC	7 PK 1793
				ALT	OE-NO.: 9121108;4405275; - AC; - ENG-PTO	7 PK 1145
				ALT	OE-NO.: 93186955;4416361; - AC; - ENG-PTO	7 PK 1105
				ALT	OE-NO.: 93195484;4418674; - AC; - ENG-PTO	7 PK 1105
				CAM		ZRK 1462
				CAM		KT 1392

#### 2.5 DTi

2463 ccm	84 kW	G9U 720;G9U 724;G9U 754	10.01 -	ALT	MTR-CODE: G9U720; - AC	6 PK 1145
				ALT	MTR-CODE: G9U720; + AC	6 PK 1795
				ALT	MTR-CODE: G9U750; + AC	7 PK 1793
				ALT	MTR-CODE: G9U750; OE-NO.: 9121108;4405275; - AC; - ENG-PTO	7 PK 1145
				ALT	MTR-CODE: G9U750; OE-NO.: 93186955;4416361; - AC; - ENG-PTO	7 PK 1105
				ALT	MTR-CODE: G9U750; OE-NO.: 93195484;4418674; - AC; - ENG-PTO	7 PK 1105
				CAM		ZRK 1462
				CAM		KT 1392

#### 2.5 CDTi

2464 ccm	74 kW	G9U 650	10.03 -	ALT	- AC; - ENG-PTO	7 PK 1110
				ALT	OE-NO.: 93195485;4418675; + AC; + ENG-PTO	7 PK 1793
				CAM		ZRK 1462
				CAM		KT 1392

#### 2.5 CDTi

2464 ccm	88 kW	G9U 632;G9U 650	10.03 -	ALT	- AC; - ENG-PTO	7 PK 1110
				ALT	OE-NO.: 93195485;4418675; + AC; + ENG-PTO	7 PK 1793
				CAM		ZRK 1462
				CAM		KT 1392

#### 2.5 CDTi

2464 ccm	107 kW	G9U 632;G9U 650	10.03 -	ALT	- AC; - ENG-PTO	7 PK 1110
				ALT	OE-NO.: 93195485;4418675; + AC; + ENG-PTO	7 PK 1793
				CAM		ZRK 1462
				CAM		KT 1392

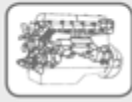

## OPEL

### MOVANO Kasten (F9)

<b>2.5 D</b>						
2499 ccm	59 kW	S8U 770;S8U 772	01.99 -	AC-C		5 PK 1200
				ALT	FROM MTR-NO: 3053819	6 PK 870
				ALT	UNTIL MTR-NO: 3053818	6 PK 858
				CAM		ZRK 1312
				CAM		KT 1229

<b>2.8 DTI</b>						
2799 ccm	84 kW	S9W 700;S9W 702	01.99 -	AC-C		5 PK 1200
				ALT	FROM MTR-NO: 3053819	6 PK 850
				ALT	UNTIL MTR-NO: 3053818	6 PK 845
				CAM		ZRK 1332
				CAM		KT 1340

<b>3.0 DTI</b>						
2953 ccm	100 kW	ZD3 200;ZD3 202	10.03 -	ALT		7 PK 1920

### MOVANO Pritsche/Fahrgestell (U9, E9)

<b>2.2 DTI</b>						
2188 ccm	66 kW	G9T 720;G9T 722;G9T 750	09.00 -	ALT	FROM: 11.04; MTR-CODE: G9T720;G9T750;G9T750; - AC; - ENG-PTO	7 PK 1105
				ALT	MTR-CODE: G9T720;G9T720;G9T750; - AC	6 PK 1145
				ALT	MTR-CODE: G9T720;G9T720;G9T750; + AC	6 PK 1795
				ALT	MTR-CODE: G9T720;G9T750;G9T750; + AC; + ENG-PTO	7 PK 1793
				ALT	UNTIL: 11.04; MTR-CODE: G9T720;G9T750;G9T750; - AC; - ENG-PTO	7 PK 1145
				CAM		ZRK 1462
				CAM		KT 1392

<b>2.5 DTi</b>						
2463 ccm	73 kW	G9U 754	10.03 -	ALT	+ AC	7 PK 1793
				ALT	OE-NO.: 9121108;4405275; - AC; - ENG-PTO	7 PK 1145
				ALT	OE-NO.: 93186955;4416361; - AC; - ENG-PTO	7 PK 1105
				ALT	OE-NO.: 93195484;4418674; - AC; - ENG-PTO	7 PK 1105
				CAM		ZRK 1462
				CAM		KT 1392

<b>2.5 DTI</b>						
2463 ccm	84 kW	G9U 720;G9U 724;G9U 750;G9U 754	10.01 -	ALT	MTR-CODE: G9U720;G9U720;G9U750; - AC	6 PK 1145
				ALT	MTR-CODE: G9U720;G9U720;G9U750; + AC	6 PK 1795
				ALT	MTR-CODE: G9U720;G9U750;G9U750; + AC	7 PK 1793
				ALT	MTR-CODE: G9U720;G9U750;G9U750; OE- NO.: 9121108;4405275; - AC; - ENG-PTO	7 PK 1145
				ALT	MTR-CODE: G9U720;G9U750;G9U750; OE- NO.: 93186955;4416361; - AC; - ENG-PTO	7 PK 1105
				ALT	MTR-CODE: G9U720;G9U750;G9U750; OE- NO.: 93195484;4418674; - AC; - ENG-PTO	7 PK 1105
				CAM		ZRK 1462
				CAM		KT 1392

<b>2.5 CDTI</b>						
2464 ccm	74 kW	G9U 650	08.06 -	ALT	- AC; - ENG-PTO	7 PK 1110
				ALT	OE-NO.: 93195485;4418675; + AC; + ENG-PTO	7 PK 1793
				CAM		ZRK 1462
				CAM		KT 1392

<b>2.5 CDTI</b>						
2464 ccm	88 kW	G9U 632;G9U 650	08.06 -	ALT	MTR-CODE: G9U650; - AC; - ENG-PTO	7 PK 1110
				ALT	MTR-CODE: G9U650; OE-NO.: 93195485;4418675; + AC; + ENG-PTO	7 PK 1793
				CAM		ZRK 1462
				CAM		KT 1392

<b>2.5 CDTI</b>						
2464 ccm	107 kW	G9U 632;G9U 650	08.06 -	ALT	MTR-CODE: G9U650; - AC; - ENG-PTO	7 PK 1110
				ALT	MTR-CODE: G9U650; OE-NO.: 93195485;4418675; + AC; + ENG-PTO	7 PK 1793
				CAM		ZRK 1462
				CAM		KT 1392

<b>2.5 D</b>						
2499 ccm	59 kW	S8U 770;S8U 772	07.98 -	AC-C	FROM: 12.99	5 PK 1200
				ALT	FROM: 12.99; FROM MTR-NO: 3053819	6 PK 870
				ALT	FROM: 12.99; UNTIL MTR-NO: 3053818	6 PK 858
				CAM		ZRK 1312

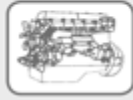

## OPEL

### MOVANO Pritsche/Fahrgestell (U9, E9)

#### 2.5 D

2499 ccm 59 kW S8U 770;S8U 772 07.98 - CAM KT 1229

#### 2.8 DTI

2799 ccm 84 kW S9W 700;S9W 702 07.98 - AC-C FROM: 12.99 5 PK 1200  
ALT FROM: 12.99; FROM MTR-NO: 3053819 6 PK 850  
ALT FROM: 12.99; UNTIL MTR-NO: 3053818 6 PK 845  
CAM ZRK 1332  
CAM KT 1340

#### 3.0 DTI

2953 ccm 100 kW ZD3 200;ZD3 202 10.03 - ALT 7 PK 1920

### MOVANO Kipper (H9)

#### 2.2 DTI

2188 ccm 66 kW G9T 720;G9T 722;G9T 750 09.00 - ALT - AC 6 PK 1145  
ALT + AC 6 PK 1795  
ALT FROM: 11.04; MTR-CODE: G9T750; - AC; - 7 PK 1105  
ENG-PTO  
ALT MTR-CODE: G9T750; + AC; + ENG-PTO 7 PK 1793  
ALT UNTIL: 11.04; MTR-CODE: G9T750; - AC; - 7 PK 1145  
ENG-PTO  
CAM ZRK 1462  
CAM KT 1392

#### 2.5 D

2499 ccm 59 kW S8U 770;S8U 772 01.99 - AC-C FROM: 12.99 5 PK 1200  
ALT FROM: 12.99; FROM MTR-NO: 3053819 6 PK 870  
ALT FROM: 12.99; UNTIL MTR-NO: 3053818 6 PK 858  
CAM ZRK 1312  
CAM KT 1229

#### 2.5 DTI

2463 ccm 73 kW G9U 754 10.03 - ALT FROM: 09.06; - AC; - ENG-PTO 7 PK 1110  
ALT FROM: 09.06; OE-NO.: 93195485;4418675; + 7 PK 1793  
AC; + ENG-PTO  
CAM ZRK 1462  
CAM KT 1392

#### 2.5 CDTI

2464 ccm 74 kW G9U 650 08.06 - ALT - AC; - ENG-PTO 7 PK 1110  
ALT OE-NO.: 93195485;4418675; + AC; + ENG-PTO 7 PK 1793  
CAM ZRK 1462  
CAM KT 1392

#### 2.5 CDTI

2464 ccm 88 kW G9U 632;G9U 650 08.06 - ALT - AC; - ENG-PTO 7 PK 1110  
ALT OE-NO.: 93195485;4418675; + AC; + ENG-PTO 7 PK 1793  
CAM ZRK 1462  
CAM KT 1392

#### 2.5 CDTI

2464 ccm 107 kW G9U 632;G9U 650 08.06 - ALT - AC; - ENG-PTO 7 PK 1110  
ALT OE-NO.: 93195485;4418675; + AC; + ENG-PTO 7 PK 1793  
CAM ZRK 1462  
CAM KT 1392

#### 2.8 DTI

2799 ccm 84 kW S9W 700;S9W 702 01.99 - AC-C FROM: 12.99 5 PK 1200  
ALT FROM: 12.99; FROM MTR-NO: 3053819 6 PK 850  
ALT FROM: 12.99; UNTIL MTR-NO: 3053818 6 PK 845  
CAM ZRK 1332  
CAM KT 1340

### VIVARO Combi (J7)

#### 2.0 ECOTEC

1998 ccm 86 kW F4R 820 08.06 - ALT - AC 5 PK 1125  
ALT + AC 6 PK 1795  
CAM MTR-CODE: F4R720;F4R820 ZRK 1475

#### 2.0 16V

1998 ccm 88 kW F4R 720 08.01 - ALT - AC 5 PK 1125  
ALT + AC 6 PK 1795  
CAM MTR-CODE: F4R720;F4R820 ZRK 1475

#### 1.9 DI

1870 ccm 60 kW F9Q 762;F9Q 774 08.01 - ALT - AC 5 PK 1125  
ALT + AC 6 PK 1795



## OPEL

### VIVARO Combi (J7)

<b>1.9 DI</b>						
1870 ccm	60 kW	F9Q 762;F9Q 774	08.01 -	CAM CAM CAM		ZRK 1067 KT 1434 KT 1434 W1
<b>1.9 DTI</b>						
1870 ccm	74 kW	F9Q 760	08.01 -	ALT ALT CAM CAM CAM	- AC + AC	5 PK 1125 6 PK 1795 ZRK 1067 KT 1434 KT 1434 W1
<b>2.0 CDTI</b>						
1995 ccm	66 kW	M9R 780;M9R 782;M9R 786	08.06 -	ALT ALT ALT	OE-NO.: 93161809;4431667; - AC; + ENG-PTO OE-NO.: 93161809;4431667; + AC; + ENG-PTO OE-NO.: 93198427;4434866; - AC; + ENG-PTO	7 PK 1970 7 PK 1970 7 PK 2000
<b>2.0 CDTI</b>						
1995 ccm	84 kW	M9R 780;M9R 784;M9R 786;M9R 788	08.06 -	ALT  ALT ALT	+ AC; + ENG-PTO  OE-NO.: 93161809;4431667; - AC; + ENG-PTO OE-NO.: 93198427;4434866; - AC; + ENG-PTO	7 PK 1970  7 PK 1970 7 PK 2000
<b>2.5 DTI</b>						
2463 ccm	99 kW	G9U 630;G9U 730	05.03 -	ALT ALT ALT CAM CAM	- AC; - ENG-PTO OE-NO.: 93161358;4430217; + AC; + ENG-PTO OE-NO.: 93196393;4418809; + AC; + ENG-PTO UNTIL: 07.06 UNTIL: 07.06	6 PK 1145 6 PK 1840 6 PK 1795 ZRK 1462 KT 1392
<b>2.5 CDTI</b>						
2463 ccm	107 kW	G9U 630	08.06 -	ALT CAM CAM	OE-NO.: 93195485;4418675; + AC; + ENG-PTO	7 PK 1793 ZRK 1462 KT 1392
<b>2.5 CDTI</b>						
2464 ccm	84 kW	G9U 630	08.06 -	ALT ALT ALT	- AC; - ENG-PTO OE-NO.: 93161358;4430217; + AC; + ENG-PTO OE-NO.: 93196393;4418809; + AC; + ENG-PTO	6 PK 1145 6 PK 1840 6 PK 1795

### VIVARO Kasten (F7)

<b>2.0 ECOTEC</b>						
1998 ccm	86 kW	F4R 820	08.06 -	ALT ALT CAM	- AC + AC MTR-CODE: F4R720;F4R820	5 PK 1125 6 PK 1795 ZRK 1475
<b>2.0 16V</b>						
1998 ccm	88 kW	F4R 720	08.01 -	ALT ALT CAM	- AC + AC MTR-CODE: F4R720;F4R820	5 PK 1125 6 PK 1795 ZRK 1475
<b>1.9 DI</b>						
1870 ccm	60 kW	F9Q 762	08.01 -	ALT ALT CAM CAM CAM	- AC + AC	5 PK 1125 6 PK 1795 ZRK 1067 KT 1434 KT 1434 W1
<b>1.9 DTI</b>						
1870 ccm	74 kW	F9Q 760	08.01 -	ALT ALT CAM CAM CAM	- AC + AC	5 PK 1125 6 PK 1795 ZRK 1067 KT 1434 KT 1434 W1
<b>2.0 CDTI</b>						
1995 ccm	66 kW	M9R 780;M9R 782;M9R 786	08.06 -	ALT ALT ALT	OE-NO.: 93161809;4431667; - AC; + ENG-PTO OE-NO.: 93161809;4431667; + AC; + ENG-PTO OE-NO.: 93198427;4434866; - AC; + ENG-PTO	7 PK 1970 7 PK 1970 7 PK 2000
<b>2.0 CDTI</b>						
1995 ccm	84 kW	M9R 780;M9R 784;M9R 786;M9R 788	08.06 -	ALT  ALT ALT	+ AC; + ENG-PTO  OE-NO.: 93161809;4431667; - AC; + ENG-PTO OE-NO.: 93198427;4434866; - AC; + ENG-PTO	7 PK 1970  7 PK 1970 7 PK 2000
<b>2.5 DTI</b>						
2463 ccm	99 kW	G9U 630;G9U 730	05.03 -	ALT ALT	- AC; - ENG-PTO OE-NO.: 93161358;4430217; + AC; + ENG-PTO	6 PK 1145 6 PK 1840

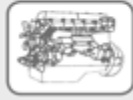

## OPEL

### VIVARO Kasten (F7)

#### 2.5 DTI

2463 ccm	99 kW	G9U 630;G9U 730	05.03 -	ALT CAM CAM	OE-NO.: 93196393;4418809; + AC; + ENG-PTO UNTIL: 07.06 UNTIL: 07.06	6 PK 1795 ZRK 1462 KT 1392
----------	-------	-----------------	---------	-------------------	---	----------------------------------

#### 2.5 CDTI

2463 ccm	107 kW	G9MB6;G9U 630	08.06 -	ALT CAM CAM	OE-NO.: 93195485;4418675; + AC; + ENG-PTO	7 PK 1793 ZRK 1462 KT 1392
----------	--------	---------------	---------	-------------------	---	----------------------------------

#### 2.5 CDTI

2464 ccm	84 kW	G9U 630	08.06 -	ALT ALT ALT	- AC; - ENG-PTO OE-NO.: 93161358;4430217; + AC; + ENG-PTO OE-NO.: 93196393;4418809; + AC; + ENG-PTO	6 PK 1145 6 PK 1840 6 PK 1795
----------	-------	---------	---------	-------------------	---	-------------------------------------

### VIVARO Pritsche/Fahrgestell (E7)

#### 2.0 ECOTEC

1998 ccm	86 kW	F4R 820	08.06 -	ALT ALT CAM	- AC + AC MTR-CODE: F4R720;F4R820	5 PK 1125 6 PK 1795 ZRK 1475
----------	-------	---------	---------	-------------------	---	------------------------------------

#### 2.0 16V

1998 ccm	88 kW	F4R 720	08.06 -	ALT ALT CAM	- AC + AC MTR-CODE: F4R720;F4R820	5 PK 1125 6 PK 1795 ZRK 1475
----------	-------	---------	---------	-------------------	---	------------------------------------

#### 1.9 DTI

1870 ccm	74 kW	F9Q 760	08.06 -	ALT ALT CAM CAM CAM	- AC + AC	5 PK 1125 6 PK 1795 ZRK 1067 KT 1434 KT 1434 W1
----------	-------	---------	---------	---------------------------------	--------------	---

#### 2.0 CDTI

1995 ccm	66 kW	M9R 782	01.06 -	ALT ALT ALT	FROM: 08.06; OE-NO.: 93161809;4431667; - AC; + ENG-PTO FROM: 08.06; OE-NO.: 93161809;4431667; + AC; + ENG-PTO FROM: 08.06; OE-NO.: 93198427;4434866; - AC; + ENG-PTO	7 PK 1970 7 PK 1970 7 PK 2000
----------	-------	---------	---------	-------------------	--	-------------------------------------

#### 2.0 CDTI

1995 ccm	84 kW	M9R 780	08.06 -	ALT ALT ALT	+ AC; + ENG-PTO OE-NO.: 93161809;4431667; - AC; + ENG-PTO OE-NO.: 93198427;4434866; - AC; + ENG-PTO	7 PK 1970 7 PK 1970 7 PK 2000
----------	-------	---------	---------	-------------------	---	-------------------------------------

#### 2.5 CDTI

2464 ccm	84 kW	G9U 630	08.06 -	ALT ALT ALT	- AC; - ENG-PTO OE-NO.: 93161358;4430217; + AC; + ENG-PTO OE-NO.: 93196393;4418809; + AC; + ENG-PTO	6 PK 1145 6 PK 1840 6 PK 1795
----------	-------	---------	---------	-------------------	---	-------------------------------------

#### 2.5 CDTI

2463 ccm	107 kW	G9U 630	08.06 -	ALT CAM CAM	OE-NO.: 93195485;4418675; + AC; + ENG-PTO	7 PK 1793 ZRK 1462 KT 1392
----------	--------	---------	---------	-------------------	---	----------------------------------

## PEUGEOT

### EXPERT (224)

#### 1.6

1581 ccm	58 kW	222A2 (1580 SPI)	02.96 -	PS AC-C ALT ALT CAM CAM	- AC + AC	AVX 10 x 675 4 PK 900 6 PK 894 6 PK 925 ZRK 1244 KT 1037
----------	-------	------------------	---------	--	--------------	---

#### 1.8

1761 ccm	74 kW	LFZ (XU7JP)	10.96 -	ALT ALT ALT CAM CAM W-P; CAM	+ AC AMP: 70,8; - AC AMP: 90; - AC	6 PK 1660 6 PK 1070 6 PK 1078 ZRK 1128 KT 1068 KT 1068 W1
----------	-------	-------------	---------	---	--	--

#### 2.0

1997 ccm	100 kW	RFN (EW10J4)	07.00 -	ALT	- AC	6 PK 1190
----------	--------	--------------	---------	-----	------	-----------



## PEUGEOT

### EXPERT (224)

#### 2.0

1997 ccm	100 kW	RFN (EW10J4)	07.00 -	ALT	+ AC	6 PK 1710
				CAM	FROM: 11.06	ZRK 1588
				CAM	UNTIL: 10.06	ZRK 1149
				CAM	FROM: 11.06	KT 1485
				CAM	UNTIL: 10.06	KT 1244
				W-P; CAM	OPT	KT 1244 W3

#### 1.9 D

1868 ccm	51 kW	WJY (DW8B);WJZ (DW8)	12.03 -	ALT	- AC; - PS	6 PK 865
				ALT	+ AC; - PS	6 PK 1045
				ALT	+ AC; + PS	6 PK 1751
				ALT	MTR-CODE: DW8; FROM ORGA-NO.: 8375; + PS; - AC	6 PK 1440
				ALT	MTR-CODE: DW8B; - AC	6 PK 1440
				ALT	MTR-CODE: DW8B; + AC	6 PK 1675

#### 1.9 D

1905 ccm	51 kW	D9B (XUD9AU)	02.96 -	VAC-P		AVX 10 x 650
				ALT	- AC; - PS	6 PK 730
				ALT	+ AC; - PS	6 PK 1165
				ALT	+ AC; + PS	6 PK 1740
				ALT	+ PS; - AC	6 PK 1115
				CAM		ZRK 1262
				CAM		KT 1040
				W-P; CAM	FROM: 02.97	KT 1040 W3
				W-P; CAM	UNTIL: 01.97	KT 1040 W1

#### 1.9 TD

1905 ccm	66 kW	DHX (XUD9TE)	02.96 -	VAC-P		AVX 10 x 650
				ALT	- AC; - PS	6 PK 730
				ALT	+ AC; - PS	6 PK 1165
				ALT	+ AC; + PS	6 PK 1740
				ALT	+ PS; - AC	6 PK 1115
				CAM		ZRK 1262
				CAM		KT 1040
				W-P; CAM	FROM: 02.97	KT 1040 W3
				W-P; CAM	UNTIL: 01.97	KT 1040 W1

#### 1.9 TD

1905 ccm	68 kW	D8B (XUD9TE)	02.96 -	VAC-P		AVX 10 x 650
				ALT	- AC; - PS	6 PK 730
				ALT	+ AC; - PS	6 PK 1165
				ALT	+ AC; + PS	6 PK 1740
				ALT	+ PS; - AC	6 PK 1115
				CAM		ZRK 1262
				CAM		KT 1040
				W-P; CAM		KT 1040 W1

#### 2.0 HDI

1997 ccm	80 kW	RHZ (DW10ATED)	07.00 -	ALT	FROM: 12.01; - AC	6 PK 1470
				ALT	FROM: 12.01; + AC	6 PK 1740
				CAM		ZRK 1352
				CAM	FROM ORGA-NO.: 08561	KT 1518
				CAM	MTR-CODE: DW10ATED4; FROM ORGA-NO.: 10011	KT 1480
				CAM	UNTIL ORGA-NO.: 08560	KT 1327
				CAM		KT 1534 W1
				W-P; CAM	FROM ORGA-NO.: 08561	KT 1518 W1
				W-P; CAM	UNTIL ORGA-NO.: 08560	KT 1327 W1

#### 2.0 HDi

1997 ccm	69 kW	RHX (DW10BTED)	10.00 -	ALT	- AC	6 PK 1470
				ALT	+ AC	6 PK 1740
				CAM		ZRK 1352
				CAM	FROM ORGA-NO.: 09868	KT 1327
				CAM	UNTIL ORGA-NO.: 09867	KT 1518
				W-P; CAM	FROM ORGA-NO.: 09868	KT 1327 W1
				W-P; CAM	UNTIL ORGA-NO.: 09867	KT 1518 W1

#### 2.0 HDI

1997 ccm	80 kW	RHW (DW10ATED4)	07.00 -	ALT	- AC	6 PK 1470
				ALT	+ AC	6 PK 1740
				CAM	FROM: 11.03; UNTIL: 04.04	ZRK 1441



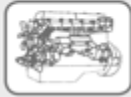

## PEUGEOT

### EXPERT (224)

#### 2.0 HDI

1997 ccm	80 kW	RHW (DW10ATED4)	07.00 -	CAM	FROM ORGA-NO.: 10011; MTR-CODE: DW10ATED4	KT 1480
				CAM	UNTIL ORGA-NO.: 10010	KT 1351
				W-P; CAM	FROM ORGA-NO.: 10011	KT 1480 W1
				W-P; CAM	UNTIL ORGA-NO.: 10010	KT 1351 W1

### EXPERT Kasten (222)

#### 1.6

1581 ccm	58 kW	222A2 (1580 SPI)	02.96 -	PS		AVX 10 x 675
				AC-C		4 PK 900
				ALT	- AC	6 PK 894
				ALT	+ AC	6 PK 925
				CAM		ZRK 1244
				CAM		KT 1037

#### 1.8

1761 ccm	74 kW	LFZ (XU7JP)	10.96 -	ALT	+ AC	6 PK 1660
				ALT	AMP: 70,8; - AC	6 PK 1070
				ALT	AMP: 90; - AC	6 PK 1078
				CAM		ZRK 1128
				CAM		KT 1068
				W-P; CAM		KT 1068 W1

#### 2.0

1997 ccm	100 kW	RFN (EW10J4)	09.02 -	ALT	- AC	6 PK 1190
				ALT	+ AC	6 PK 1710
				CAM	FROM: 11.06	ZRK 1588
				CAM	UNTIL: 10.06	ZRK 1149
				CAM	FROM: 11.06	KT 1485
				CAM	UNTIL: 10.06	KT 1244
				W-P; CAM	OPT	KT 1244 W3

#### 1.9 D 70

1868 ccm	51 kW	WJY (DW8B);WJZ (DW8)	12.98 -	ALT	- AC; - PS	6 PK 865
				ALT	+ AC; - PS	6 PK 1045
				ALT	+ AC; + PS	6 PK 1751
				ALT	FROM: 10.99; MTR-CODE: DW8; FROM ORGA-NO.: 8375; + PS; - AC	6 PK 1440
				ALT	FROM: 12.02; MTR-CODE: DW8B; + AC	6 PK 1675
				ALT	MTR-CODE: DW8B; - AC	6 PK 1440
				ALT	UNTIL: 10.99; UNTIL ORGA-NO.: 8374; + PS; - AC	6 PK 1390
				ALT	UNTIL: 12.02; MTR-CODE: DW8B; UNTIL ORGA-NO.: 09520; + AC	6 PK 1735
				CAM		ZRK 1351
				CAM		KT 1433
				W-P; CAM	MTR-CODE: DW8	KT 1517 W1

#### 1.9 D

1905 ccm	51 kW	D9B (XUD9AU)	02.96 -	ALT	- AC; - PS	6 PK 730
				ALT	+ AC; - PS	6 PK 1165
				ALT	+ AC; + PS	6 PK 1740
				ALT	+ PS; - AC	6 PK 1115
				CAM		ZRK 1262
				CAM		KT 1040
				W-P; CAM	FROM: 02.97	KT 1040 W3
				W-P; CAM	UNTIL: 01.97	KT 1040 W1

#### 1.9 TD

1905 ccm	66 kW	DHX (XUD9TE)	02.96 -	ALT	- AC; - PS	6 PK 730
				ALT	+ AC; - PS	6 PK 1165
				ALT	+ AC; + PS	6 PK 1740
				ALT	+ PS; - AC	6 PK 1115
				CAM		ZRK 1262
				CAM		KT 1040
				W-P; CAM	FROM: 02.97	KT 1040 W3
				W-P; CAM	UNTIL: 01.97	KT 1040 W1

#### 1.9 TD

1905 ccm	68 kW	D8B (XUD9TE)	02.96 -	ALT	- AC; - PS	6 PK 730
				ALT	+ AC; - PS	6 PK 1165
				ALT	+ AC; + PS	6 PK 1740
				ALT	+ PS; - AC	6 PK 1115



## PEUGEOT

### EXPERT Kasten (222)

#### 1.9 TD

1905 ccm	68 kW	D8B (XUD9TE)	02.96 -	CAM		ZRK 1262
				CAM		KT 1040
				W-P; CAM	FROM: 02.97	KT 1040 W3
				W-P; CAM	UNTIL: 01.97	KT 1040 W1

#### 2.0 HDI

1997 ccm	69 kW	RHX (DW10BTED)	07.00 -	ALT	- AC	6 PK 1470
				ALT	+ AC	6 PK 1740
				CAM		ZRK 1352
				CAM	FROM ORGA-NO.: 09868	KT 1327
				CAM	UNTIL ORGA-NO.: 09867	KT 1518
				W-P; CAM	FROM ORGA-NO.: 09868	KT 1327 W1
				W-P; CAM	UNTIL ORGA-NO.: 09867	KT 1518 W1

#### 2.0 HDI

1997 ccm	80 kW	RHZ (DW10ATED)	07.00 -	ALT	FROM: 12.01; - AC	6 PK 1470
				ALT	FROM: 12.01; + AC	6 PK 1740
				CAM		ZRK 1352
				CAM	FROM ORGA-NO.: 08561	KT 1518
				CAM	FROM ORGA-NO.: 10011; MTR-CODE: DW10ATED04	KT 1480
				CAM	UNTIL ORGA-NO.: 08560	KT 1327
				CAM	MTR-CODE: DW10CTED	KT 1534 W1
				W-P; CAM	FROM ORGA-NO.: 08561	KT 1518 W1
				W-P; CAM	UNTIL ORGA-NO.: 08560	KT 1327 W1

#### 2.0 HDI

1997 ccm	80 kW	RHW (DW10ATED4)	07.00 -	ALT	- AC	6 PK 1470
				ALT	+ AC	6 PK 1740
				CAM	FROM: 11.03; UNTIL: 04.04	ZRK 1441
				CAM	FROM ORGA-NO.: 10011; MTR-CODE: DW10ATED4	KT 1480
				CAM	UNTIL ORGA-NO.: 10010	KT 1351
				W-P; CAM	FROM ORGA-NO.: 10011	KT 1480 W1
				W-P; CAM	UNTIL ORGA-NO.: 10010	KT 1351 W1

### EXPERT Pritsche/Fahrgestell (223)

#### 1.6

1581 ccm	58 kW	222A2 (1580 SPI)	02.96 -	PS		AVX 10 x 675
				AC-C		4 PK 900
				ALT	- AC	6 PK 894
				ALT	+ AC	6 PK 925
				CAM		ZRK 1244
				CAM		KT 1037

#### 1.9 D

1868 ccm	51 kW	WJY (DW8B);WJZ (DW8)	06.98 -	ALT	- AC; - PS	6 PK 865
				ALT	+ AC; - PS	6 PK 1045
				ALT	+ AC; + PS	6 PK 1751
				ALT	FROM: 10.99; MTR-CODE: DW8; FROM ORGA- NO.: 8375; + PS; - AC	6 PK 1440
				ALT	FROM: 12.02; MTR-CODE: DW8B; + AC	6 PK 1675
				ALT	MTR-CODE: DW8B; - AC	6 PK 1440
				ALT	UNTIL: 10.99; UNTIL ORGA-NO.: 8374; + PS; - AC	6 PK 1390
				ALT	UNTIL: 12.02; MTR-CODE: DW8B; UNTIL ORGA-NO.: 09520; + AC	6 PK 1735

#### 1.9 D

1905 ccm	51 kW	D9B (XUD9AU)	02.96 -	ALT	- AC; - PS	6 PK 730
				ALT	+ AC; - PS	6 PK 1165
				ALT	+ AC; + PS	6 PK 1740
				ALT	+ PS; - AC	6 PK 1115
				CAM		ZRK 1262
				CAM		KT 1040
				W-P; CAM	FROM: 02.97	KT 1040 W3
				W-P; CAM	UNTIL: 01.97	KT 1040 W1

#### 1.9 TD

1905 ccm	66 kW	DHX (XUD9TE)	02.96 -	ALT	- AC; - PS	6 PK 730
				ALT	+ AC; - PS	6 PK 1165
				ALT	+ AC; + PS	6 PK 1740
				ALT	+ PS; - AC	6 PK 1115

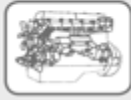

## PEUGEOT

### EXPERT Pritsche/Fahrgestell (223)

#### 1.9 TD

1905 ccm	66 kW	DHX (XUD9TE)	02.96 -	CAM		ZRK 1262
				CAM		KT 1040
				W-P; CAM	FROM: 02.97	KT 1040 W3
				W-P; CAM	UNTIL: 01.97	KT 1040 W1

#### 1.9 TD

1905 ccm	68 kW	D8B (XUD9TE)	02.96 -	ALT	- AC; - PS	6 PK 730
				ALT	+ AC; - PS	6 PK 1165
				ALT	+ AC; + PS	6 PK 1740
				ALT	+ PS; - AC	6 PK 1115
				CAM		ZRK 1262
				CAM		KT 1040
				W-P; CAM	FROM: 02.97	KT 1040 W3
				W-P; CAM	UNTIL: 01.97	KT 1040 W1

#### 2.0 HDi

1997 ccm	80 kW	RHW (DW10ATED4)	10.00 -	ALT	MTR-CODE: DW10ATED;DW10CTED+; - AC	6 PK 1470
				ALT	MTR-CODE: DW10ATED;DW10CTED+; + AC	6 PK 1740
				ALT	MTR-CODE: DW10ATED4; - AC	6 PK 1470
				ALT	MTR-CODE: DW10ATED4; + AC	6 PK 1740

### EXPERT Tepee (VF3V\_)

#### 2.0 16V

1997 ccm	103 kW	RFH (EW10A);RFJ (EW10A)	01.07 -	ALT		6 PK 1000
				CAM		ZRK 1588
				CAM		KT 1485
				W-P; CAM		KT 1504 W1

#### 1.6 HDi 90

1560 ccm	66 kW	9HU (DV6UTED4)	01.07 -	ALT	MTR-CODE: DV6UTED4; - AC	6 PK 1352
				ALT	MTR-CODE: DV6UTED4; + AC	6 PK 1710
				CAM		ZRK 1460
				CAM		KT 1390
				W-P; CAM		KT 1390 W1

#### 2.0 HDi 100

1997 ccm	72 kW		03.11 -	CAM	FROM: 07.11	ZRK 1592
				CAM	FROM: 07.11	KT 1500

#### 2.0 HDi 120

1997 ccm	88 kW	RHK (DW10UTED4)	01.07 -	ALT		6 PK 1215
				CAM		ZRK 1452
				CAM		KT 1428
				W-P; CAM		KT 1428 W1

#### 2.0 HDi 120 4x4

1997 ccm	88 kW	RHK (DW10UTED4)	01.07 -	W-P; CAM		KT 1428 W1
----------	-------	-----------------	---------	----------	--	------------

#### 2.0 HDi 130

1997 ccm	94 kW		03.11 -	CAM	FROM: 07.11	ZRK 1592
				CAM	FROM: 07.11	KT 1500

#### 2.0 HDi 140

1997 ccm	100 kW	RHR (DW10BTED4)	01.07 -	ALT		6 PK 1215
				CAM		ZRK 1452
				CAM		KT 1428
				W-P; CAM		KT 1428 W1

#### 2.0 HDi 165

1997 ccm	120 kW	RHH (DW10CTED4)	09.09 -	ALT	FROM: 04.10	6 PK 1245
				CAM	FROM: 04.10	ZRK 1592
				CAM	FROM: 04.10	KT 1500

### EXPERT Kasten (VF3A\_, VF3U\_, VF3X\_)

#### 2.0 16V

1997 ccm	103 kW	RFH (EW10A);RFJ (EW10A)	01.07 -	ALT		6 PK 1000
				CAM		ZRK 1588
				CAM		KT 1504
				W-P; CAM		KT 1504 W1

#### 1.6 HDi 90

1560 ccm	66 kW	9HU (DV6UTED4)	01.07 -	ALT	- AC	6 PK 1352
				ALT	+ AC	6 PK 1710
				CAM		ZRK 1460
				CAM		KT 1390
				W-P; CAM		KT 1390 W1



## PEUGEOT

### EXPERT Kasten (VF3A\_, VF3U\_, VF3X\_)

#### 2.0 HDi 120

1997 ccm	88 kW	RHK (DW10UTED4)	01.07 -	ALT CAM CAM W-P; CAM		6 PK 1215 ZRK 1452 KT 1428 KT 1428 W1
----------	-------	-----------------	---------	-------------------------------	--	--

#### 2.0 HDi 130

1997 ccm	94 kW		03.11 -	CAM CAM	FROM: 07.11 FROM: 07.11	ZRK 1592 KT 1500
----------	-------	--	---------	------------	----------------------------	---------------------

#### 2.0 HDi 140

1997 ccm	100 kW	RHR (DW10BTED4)	01.07 -	ALT CAM CAM W-P; CAM		6 PK 1215 ZRK 1452 KT 1428 KT 1428 W1
----------	--------	-----------------	---------	-------------------------------	--	--

#### 2.0 HDi 165

1997 ccm	120 kW	RHH (DW10CTED4)	09.09 -	ALT CAM CAM	FROM: 04.10 FROM: 04.10 FROM: 04.10	6 PK 1245 ZRK 1592 KT 1500
----------	--------	-----------------	---------	-------------------	---	----------------------------------

### EXPERT Pritsche/Fahrgestell

#### 1.6 HDi 90

1560 ccm	66 kW	9HU (DV6UTED4)	01.07 -	ALT ALT CAM CAM W-P; CAM	FROM: 06.07; - AC FROM: 06.07; + AC	6 PK 1352 6 PK 1710 ZRK 1460 KT 1390 KT 1390 W1
----------	-------	----------------	---------	--------------------------------------	--	---

#### 2.0 HDi 120

1997 ccm	88 kW	RHK (DW10UTED4)	01.07 -	ALT W-P; CAM	FROM: 06.07	6 PK 1215 KT 1428 W1
----------	-------	-----------------	---------	-----------------	-------------	-------------------------

#### 2.0 HDi 140

1997 ccm	100 kW	RHR (DW10BTED4)	01.07 -	ALT W-P; CAM		6 PK 1215 KT 1428 W1
----------	--------	-----------------	---------	-----------------	--	-------------------------

### PARTNER Combispace (5F)

#### 1.1

1124 ccm	44 kW	HDZ (TU1M);HFX (TU1JP)	06.96 -	ALT ALT ALT ALT ALT PS PS CAM CAM CAM CAM CAM CAM CAM CAM CAM W-P; CAM	- PS FROM: 09.00; MTR-CODE: TU1JP; - AC FROM: 09.00; MTR-CODE: TU1JP; + AC MTR-CODE: TU1M+; - PS; + V-PUL MTR-CODE: TU1M+; + PS MTR-CODE: TU1M+; - AC MTR-CODE: TU1M+; + AC FROM MTR-NO: 3762435; MTR-CODE: TU1JP MTR-CODE: TU1M UNTIL MTR-NO: 3762434; MTR-CODE: TU1JP FROM MTR-NO: 3762435 MTR-CODE: TU1M UNTIL MTR-NO: 3762434; MTR-CODE: TU1JP MTR-CODE: TU1M UNTIL MTR-NO: 3762434; MTR-CODE: TU1JP FROM MTR-NO: 3762434; MTR-CODE: TU1JP	AVX 10 x 715 AVX 10 x 710 6 PK 1450 6 PK 1560 5 PK 715 4 PK 855 5 PK 880 5 PK 1255 ZRK 1467 ZRK 1114 ZRK 1114 KT 1398 KT 1013 KT 1013 KT 1013 W1 KT 1013 W1 KT 1398 W1
----------	-------	------------------------	---------	--	---	--

#### 1.4

1360 ccm	54 kW	KFW (TU3JP)	11.02 -	ALT ALT ALT ALT ALT W-P; CAM	FROM: 10.05; MTR-CODE: TU3A;TU3JP; + AC FROM: 10.05; MTR-CODE: TU3A;TU3JP; FROM ORGA-NO.: 10563; + AC MTR-CODE: TU3A;TU3JP; - AC UNTIL: 10.05; MTR-CODE: TU3A;TU3JP; + AC UNTIL: 10.05; MTR-CODE: TU3A;TU3JP; UNTIL ORGA-NO.: 10562; + AC MTR-CODE: TU3A	6 PK 1565 6 PK 1565 6 PK 1450 6 PK 1560 6 PK 1560 KT 1370 W1
----------	-------	-------------	---------	---	---	---

#### 1.4

1360 ccm	55 kW	KFW (TU3JP);KFX (TU3JP);TU32	06.96 -	ALT ALT ALT ALT	FROM: 08.00; MTR-CODE: TU3JP; - AC FROM: 09.00; UNTIL: 10.02; MTR-CODE: TU3JP; UNTIL ORGA-NO.: 10562; + AC FROM: 10.05; MTR-CODE: TU3JP; FROM ORGA-NO.: 10563; + AC	AVX 10 x 715 6 PK 1450 6 PK 1560 6 PK 1565
----------	-------	------------------------------	---------	--------------------------	---	---



## PEUGEOT

### PARTNER Combispace (5F)

1.4						
1360 ccm	55 kW	KFW (TU3JP);KFX (TU3JP);TU32	06.96 -	ALT	FROM: 10.96; MTR-CODE: TU3JP; - AC; - PS; + V-PUL	5 PK 715
				ALT	FROM: 10.96; MTR-CODE: TU3JP; + AC	4 PK 855
				ALT	FROM: 10.96; MTR-CODE: TU3JP; + PS; - AC	4 PK 855
				ALT	FROM: 10.96; UNTIL: 08.00; MTR-CODE: TU3JP; + AC	4 PK 855
				ALT	FROM: 10.96; UNTIL: 08.00; MTR-CODE: TU3JP; + PS; - AC	4 PK 855
				PS	FROM: 10.96; MTR-CODE: TU3JP; - AC	5 PK 880
				PS	FROM: 10.96; MTR-CODE: TU3JP; + AC	5 PK 1255
				CAM	FROM MTR-NO: 3666766	ZRK 1457
				CAM	UNTIL MTR-NO: 3666765	ZRK 1118
				CAM	FROM MTR-NO: 3666766	KT 1370
				CAM	UNTIL MTR-NO: 3666765	KT 1019
				W-P; CAM	FROM MTR-NO: 3666766	KT 1370 W1
				W-P; CAM	UNTIL MTR-NO: 3666765	KT 1019 W1
1.6 16V						
1587 ccm	80 kW	NFU (TU5JP4)	07.01 -	ALT	- AC	6 PK 1450
				ALT	- AC; FROM: 2002	6 PK 1450
				ALT	FROM: 02.05; FROM ORGA-NO.: 10311; + AC	6 PK 1565
				ALT	UNTIL: 01.05; UNTIL ORGA-NO.: 10310; + AC	6 PK 1560
				ALT	UNTIL: 01.05; UNTIL ORGA-NO.: 10310; + AC; FROM: 2002	6 PK 1560
				ALT	UNTIL: 2002	4 PK 855
				PS	- AC; UNTIL: 2002	5 PK 880
				PS	+ AC; UNTIL: 2002	5 PK 1255
				CAM		ZRK 1537
				CAM	FROM MTR-NO: 1806405	KT 1332
				CAM	UNTIL MTR-NO: 1806404	KT 1330
				W-P; CAM	FROM MTR-NO: 1806405	KT 1332 W1
				W-P; CAM	UNTIL MTR-NO: 1806404	KT 1330 W1
1.8						
1761 ccm	66 kW	LFX (XU7JB)	05.97 -	ALT	- AC; - PS	6 PK 750
				ALT	+ AC; + PS	6 PK 1660
				ALT	+ PS; - AC	6 PK 1078
				CAM		ZRK 1128
				CAM		KT 1068
				W-P; CAM		KT 1068 W1
1.6 HDi 75						
1560 ccm	55 kW	9HW (DV6BTED4)	02.06 -	ALT	- AC	6 PK 1352
				ALT	+ AC	6 PK 1710
				CAM		ZRK 1460
				CAM		KT 1390
				W-P; CAM		KT 1390 W1
1.6 HDi 90						
1560 ccm	66 kW	9HX (DV6ATED4)	02.06 -	ALT	+ AC	6 PK 1710
				ALT	FROM ORGA-NO.: 10571; - AC	6 PK 1352
				CAM		ZRK 1460
				CAM		KT 1390
				W-P; CAM		KT 1390 W1
1.9 D						
1905 ccm	50 kW	DJY (XUD9A)	06.96 -	ALT	- AC; - PS	6 PK 730
				ALT	+ AC; - PS	6 PK 1165
				ALT	+ AC; + PS	6 PK 1740
				ALT	+ PS; - AC	6 PK 1115
				CAM		ZRK 1262
				CAM		KT 1040
				W-P; CAM	FROM: 02.97	KT 1040 W3
				W-P; CAM	UNTIL: 01.97	KT 1040 W1
1.9 D						
1868 ccm	51 kW	WJY (DW8B);WJZ (DW8)	12.98 -	ALT	- AC; - PS	6 PK 865
				ALT	+ AC; - PS	6 PK 1045
				ALT	FROM: 11.02; + AC; + PS	6 PK 1675
				ALT	FROM: 11.99; FROM ORGA-NO.: 8400; + PS; - AC	6 PK 1440
				ALT	UNTIL: 10.02; + AC; + PS	6 PK 1695
				ALT	UNTIL: 10.02; + AC; + PS	6 PK 1751



## PEUGEOT

### PARTNER Combispace (5F)

<b>1.9 D</b>						
1868 ccm	51 kW	WJY (DW8B);WJZ (DW8)	12.98 -	ALT	UNTIL: 11.99; UNTIL ORGA-NO.: 8399; + PS; - AC	6 PK 1390
				CAM		ZRK 1351
				CAM		KT 1433
				W-P; CAM		KT 1517 W1
<b>1.9 D 4x4</b>						
1868 ccm	51 kW	WJY (DW8B)	04.04 -	ALT	- AC; - PS	6 PK 865
				ALT	+ AC; - PS	6 PK 1045
				ALT	+ AC; + PS	6 PK 1675
				ALT	+ PS; - AC	6 PK 1440
				CAM		ZRK 1351
				CAM		KT 1433
				W-P; CAM		KT 1517 W1
<b>1.9 D</b>						
1905 ccm	51 kW	XUD9	05.96 -	ALT	- AC; - PS	6 PK 730
				ALT	+ AC; - PS	6 PK 1165
				ALT	+ AC; + PS	6 PK 1740
				ALT	+ PS; - AC	6 PK 1115
				CAM		ZRK 1262
				CAM		KT 1040
				W-P; CAM	FROM: 02.97	KT 1040 W3
				W-P; CAM	UNTIL: 01.97	KT 1040 W1
<b>2.0 HDI</b>						
1997 ccm	66 kW	RHY (DW10TD)	02.00 -	ALT	- AC	6 PK 1470
				ALT	FROM: 11.02; + AC	6 PK 1740
				ALT	UNTIL: 10.02; + AC	6 PK 1751
				CAM		ZRK 1352
				CAM	FROM ORGA-NO.: 08736	KT 1518
				CAM	UNTIL ORGA-NO.: 08735	KT 1327
				CAM	FROM: 10.00	KT 1534 W1
				W-P; CAM	FROM ORGA-NO.: 08736	KT 1518 W1
				W-P; CAM	UNTIL ORGA-NO.: 08735	KT 1327 W1
<b>2.0 HDi 4x4</b>						
1997 ccm	66 kW	RHY (DW10TD)	04.04 -	ALT	- AC	6 PK 1470
				ALT	+ AC	6 PK 1740
				CAM	FROM ORGA-NO.: 08736	KT 1518
				CAM		KT 1534 W1
				W-P; CAM	FROM ORGA-NO.: 08736	KT 1518 W1
				W-P; CAM	UNTIL ORGA-NO.: 08735	KT 1327 W1
<b>PARTNER Kasten (5)</b>						
<b>1.1</b>						
1124 ccm	44 kW	HDZ (TU1M)	06.96 -	ALT		AVX 10 x 715
				ALT	- AC; - PS	AVX 10 x 710
				ALT	MTR-CODE: TU1JP; - AC	6 PK 1450
				ALT	MTR-CODE: TU1JP; + AC	6 PK 1560
				ALT	MTR-CODE: TU1M+; - PS; + V-PUL	5 PK 715
				ALT	MTR-CODE: TU1M+; + PS	4 PK 855
				PS	MTR-CODE: TU1M+; - AC	5 PK 880
				PS	MTR-CODE: TU1M+; + AC	5 PK 1255
				CAM		ZRK 1114
				CAM		KT 1013
				CAM		KT 1013 W1
				CAM	MTR-CODE: TU1JP	KT 1398 W2
				W-P; CAM	FROM MTR-NO: 3762434	KT 1398 W1
<b>1.4</b>						
1360 ccm	55 kW	KFX (TU3JP);TU32	06.96 -	ALT		AVX 10 x 715
				ALT	- AC; - PS	AVX 10 x 710
				ALT	FROM: 09.00; MTR-CODE: TU3JP; - AC	6 PK 1450
				ALT	FROM: 09.00; MTR-CODE: TU3JP; UNTIL ORGA-NO.: 10562; + AC	6 PK 1560
				ALT	FROM: 10.05; MTR-CODE: TU32;TU3A;TU3JP; + AC	6 PK 1565
				ALT	FROM: 11.02; MTR-CODE: TU32;TU3A;TU3JP; - AC	6 PK 1450
				ALT	FROM: 11.02; UNTIL: 10.05; MTR-CODE: TU32;TU3A;TU3JP; + AC	6 PK 1560
				ALT	UNTIL: 08.00; MTR-CODE: TU3JP; - AC; - PS	5 PK 715



## PEUGEOT

### PARTNER Kasten (5)

1.4						
1360 ccm	55 kW	KFX (TU3JP);TU32	06.96 -	ALT	UNTIL: 08.00; MTR-CODE: TU3JP; + AC	4 PK 855
				ALT	UNTIL: 08.00; MTR-CODE: TU3JP; + PS; - AC	4 PK 855
				ALT	UNTIL: 10.02; MTR-CODE: TU32;TU3A;TU3JP; - AC; - PS; + V-PUL	5 PK 715
				ALT	UNTIL: 10.02; MTR-CODE: TU32;TU3A;TU3JP; + AC	4 PK 855
				ALT	UNTIL: 10.02; MTR-CODE: TU32;TU3A;TU3JP; + PS; - AC	4 PK 855
				PS	UNTIL: 08.00; MTR-CODE: TU3JP; - AC	5 PK 880
				PS	UNTIL: 08.00; MTR-CODE: TU3JP; + AC	5 PK 1255
				PS	UNTIL: 10.02; MTR-CODE: TU32;TU3A;TU3JP; - AC	5 PK 880
				PS	UNTIL: 10.02; MTR-CODE: TU32;TU3A;TU3JP; + AC	5 PK 1255
				CAM	FROM MTR-NO: 3666766	ZRK 1457
				CAM	UNTIL MTR-NO: 3666765	ZRK 1118
				CAM	FROM MTR-NO: 3666766	KT 1370
				CAM	UNTIL MTR-NO: 3666765	KT 1019
				W-P; CAM	FROM MTR-NO: 3666766	KT 1370 W1
				W-P; CAM	UNTIL MTR-NO: 3666765	KT 1019 W1
1.4 BiFuel						
1360 ccm	55 kW	KFW (TU3JP)	04.03 -	ALT	- AC	6 PK 1450
				ALT	+ AC	6 PK 1565
				CAM		ZRK 1457
				CAM		KT 1370
				W-P; CAM	FROM MTR-NO: 3666766	KT 1370 W1
				W-P; CAM	UNTIL MTR-NO: 3666765	KT 1019 W1
1.6						
1587 ccm	80 kW	NFU (TU5JP4)	09.00 -	ALT	MTR-CODE: TU5JP4	4 PK 855
				PS	MTR-CODE: TU5JP4; - AC	5 PK 880
				PS	MTR-CODE: TU5JP4; + AC	5 PK 1255
				CAM	MTR-CODE: TU5JP4	ZRK 1537
				CAM	MTR-CODE: TU5JP4	KT 1332
1.6 HDi 75						
1560 ccm	55 kW	9HW (DV6BTED4)	02.06 -	ALT	MTR-CODE: DV6B; - AC	6 PK 1352
				ALT	MTR-CODE: DV6B; + AC	6 PK 1710
				ALT	MTR-CODE: DV6BTED4; - AC	6 PK 1352
				ALT	MTR-CODE: DV6BTED4; + AC	6 PK 1710
				CAM		ZRK 1460
				CAM		KT 1390
				W-P; CAM		KT 1390 W1
1.6 HDi 90						
1560 ccm	66 kW	9HX (DV6ATED4)	02.06 -	ALT	- AC	6 PK 1352
				ALT	+ AC	6 PK 1710
				CAM		ZRK 1460
				CAM		KT 1390
				W-P; CAM		KT 1390 W1
1.8 D						
1769 ccm	43 kW	A9A (XUD7)	06.96 -	ALT	- AC; - PS	6 PK 730
				ALT	+ AC; - PS	6 PK 1165
				ALT	+ AC; + PS	6 PK 1740
				ALT	+ PS; - AC	6 PK 1115
				CAM		ZRK 1262
				CAM		KT 1040
				W-P; CAM	FROM: 02.97	KT 1040 W3
				W-P; CAM	UNTIL: 01.97	KT 1040 W1
1.8 D						
1769 ccm	44 kW	A9A (XUD7)	11.96 -	ALT	- AC; - PS	6 PK 730
				ALT	+ AC; - PS	6 PK 1165
				ALT	+ AC; + PS	6 PK 1740
				ALT	+ PS; - AC	6 PK 1115
1.9 D						
1905 ccm	50 kW	DJY (XUD9A)	05.96 -	ALT	- AC; - PS	6 PK 730
				ALT	+ AC; - PS	6 PK 1165
				ALT	+ AC; + PS	6 PK 1740
				ALT	+ PS; - AC	6 PK 1115
				CAM		ZRK 1262



## PEUGEOT

### PARTNER Kasten (5)

<b>1.9 D</b>						
1905 ccm	50 kW	DJY (XUD9A)	05.96 -	CAM		KT 1040
<b>1.9 D</b>						
1905 ccm	51 kW	DJY (XUD9A)	06.96 -	ALT	- AC; - PS	6 PK 730
				ALT	+ AC; - PS	6 PK 1165
				ALT	+ AC; + PS	6 PK 1740
				ALT	+ PS; - AC	6 PK 1115
				CAM		ZRK 1262
				CAM		KT 1040
				W-P; CAM	FROM: 02.97	KT 1040 W3
				W-P; CAM	UNTIL: 01.97	KT 1040 W1
<b>1.9 D 4x4</b>						
1868 ccm	51 kW	WJY (DW8B)	04.04 -	ALT	- AC; - PS	6 PK 865
				ALT	+ AC; - PS	6 PK 1045
				ALT	+ AC; + PS	6 PK 1675
				ALT	+ PS; - AC	6 PK 1440
				CAM		ZRK 1351
				CAM		KT 1433
				W-P; CAM		KT 1517 W1
<b>1.9 D</b>						
1868 ccm	51 kW	WJY (DW8B);WJZ (DW8)	06.96 -	ALT	FROM: 11.02; MTR-CODE: DW8;DW8B; + AC; + PS	6 PK 1675
				ALT	FROM: 11.99; MTR-CODE: DW8;DW8B; FROM ORGA-NO.: 8400; + PS; - AC	6 PK 1440
				ALT	MTR-CODE: DW8;DW8B; - AC; - PS	6 PK 865
				ALT	MTR-CODE: DW8;DW8B; + AC; - PS	6 PK 1045
				ALT	UNTIL: 10.02; MTR-CODE: DW8;DW8B; + AC; + PS	6 PK 1695
				ALT	UNTIL: 10.02; MTR-CODE: DW8;DW8B; + AC; + PS	6 PK 1751
				ALT	UNTIL: 11.99; MTR-CODE: DW8;DW8B; UNTIL ORGA-NO.: 8399; + PS; - AC	6 PK 1390
				CAM		ZRK 1351
				CAM		KT 1433
				W-P; CAM		KT 1517 W1
<b>2.0 HDi</b>						
1997 ccm	66 kW	RHY (DW10TD)	04.00 -	ALT	- AC	6 PK 1470
				ALT	FROM: 11.02; + AC	6 PK 1740
				ALT	UNTIL: 10.02; + AC	6 PK 1751
				CAM		ZRK 1352
				CAM	FROM ORGA-NO.: 08736	KT 1518
				CAM	UNTIL ORGA-NO.: 8735	KT 1327
				CAM	FROM: 10.00	KT 1534 W1
				W-P; CAM	FROM ORGA-NO.: 08736	KT 1518 W1
				W-P; CAM	UNTIL ORGA-NO.: 08735	KT 1327 W1
<b>2.0 HDi 4x4</b>						
1997 ccm	66 kW	RHY (DW10TD)	04.04 -	ALT	- AC	6 PK 1470
				ALT	+ AC	6 PK 1740
				CAM		ZRK 1352
				CAM	UNTIL ORGA-NO.: 8735	KT 1327
<b>PARTNER Tepee</b>						
<b>1.6</b>						
1587 ccm	66 kW	NFR (TU5JP4B)	04.08 -	ALT	- AC	6 PK 1205
				ALT	+ AC	6 PK 1700
				CAM		ZRK 1537
				CAM		KT 1332
				W-P; CAM		KT 1332 W1
<b>1.6</b>						
1587 ccm	80 kW	NFU (TU5JP4)	04.08 -	ALT	MTR-CODE: TU5JP4; - AC	6 PK 1205
				ALT	MTR-CODE: TU5JP4; + AC	6 PK 1700
				CAM		ZRK 1537
				CAM		KT 1332
				W-P; CAM		KT 1332 W1
<b>1.6 HDi</b>						
1560 ccm	55 kW	9HT (DV6BTED4)	04.08 -	ALT	- AC	6 PK 1352
				ALT	+ AC	6 PK 1710
				CAM	MTR-CODE: DV6ATED4;DV6TED4	ZRK 1460



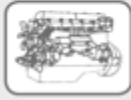

## PEUGEOT

### PARTNER Tepee

#### 1.6 HDi

1560 ccm	55 kW	9HT (DV6BTED4)	04.08 -	CAM W-P; CAM	MTR-CODE: DV6ATED4;DV6TED4	KT 1390 KT 1390 W1
----------	-------	----------------	---------	-----------------	----------------------------	-----------------------

#### 1.6 HDi

1560 ccm	66 kW	9HX (DV6ATED4)	04.08 -	ALT	MTR-CODE: DV6ATED4;DV6ATED4;DV6TED4; - AC	6 PK 1352
				ALT	MTR-CODE: DV6ATED4;DV6ATED4;DV6TED4; + AC	6 PK 1710
				ALT	MTR-CODE: DV6ATED4;DV6TED4;DV6TED4; - AC	6 PK 800
				ALT	MTR-CODE: DV6ATED4;DV6TED4;DV6TED4; + AC	6 PK 975
				CAM	MTR-CODE: DV6ATED4;DV6TED4	ZRK 1460
				CAM	MTR-CODE: DV6ATED4;DV6TED4	KT 1390
				W-P; CAM		KT 1390 W1

#### 1.6 HDi

1560 ccm	80 kW	9HZ (DV6TED4)	04.08 -	ALT	MTR-CODE: DV6TED4; - AC	6 PK 800
				ALT	MTR-CODE: DV6TED4; + AC	6 PK 975
				CAM	MTR-CODE: DV6ATED4;DV6TED4	ZRK 1460
				CAM	MTR-CODE: DV6ATED4;DV6TED4	KT 1390
				W-P; CAM		KT 1390 W1

### PARTNER Kasten

#### 1.6

1587 ccm	66 kW	NFR (TU5JP4B)	04.08 -	ALT	- AC	6 PK 1205
				ALT	+ AC	6 PK 1700
				CAM		ZRK 1537
				CAM		KT 1332
				W-P; CAM		KT 1332 W1

#### 1.6

1587 ccm	80 kW	NFU (TU5JP4)	04.08 -	ALT	MTR-CODE: TU5JP4; - AC	6 PK 1205
				ALT	MTR-CODE: TU5JP4; + AC	6 PK 1700
				CAM		ZRK 1537
				CAM		KT 1332
				W-P; CAM	MTR-CODE: TU5JP4	KT 1332 W1

#### 1.6 HDi

1560 ccm	55 kW	9HT (DV6BTED4)	04.08 -	ALT	MTR-CODE: DV6BUTED4; - AC	6 PK 1352
				ALT	MTR-CODE: DV6BUTED4; + AC	6 PK 1710
				CAM	MTR-CODE: DV6ATED4;DV6TED4	ZRK 1460
				CAM	MTR-CODE: DV6ATED4;DV6TED4	KT 1390
				W-P; CAM		KT 1390 W1

#### 1.6 HDi

1560 ccm	66 kW	9HX (DV6ATED4)	04.08 -	ALT	MTR-CODE: DV6AUTED4; - AC	6 PK 1352
				ALT	MTR-CODE: DV6AUTED4; + AC	6 PK 1710
				CAM	MTR-CODE: DV6ATED4;DV6TED4	ZRK 1460
				CAM	MTR-CODE: DV6ATED4;DV6TED4	KT 1390
				W-P; CAM		KT 1390 W1

#### 1.6 HDi

1560 ccm	80 kW	9HZ (DV6TED4)	04.08 -	ALT	MTR-CODE: DV6TED4; - AC	6 PK 800
				ALT	MTR-CODE: DV6TED4; + AC	6 PK 975
				CAM	MTR-CODE: DV6ATED4;DV6TED4	ZRK 1460
				CAM	MTR-CODE: DV6ATED4;DV6TED4	KT 1390
				W-P; CAM		KT 1390 W1

### BOXER Bus (230P)

#### 2.0 i

1998 ccm	80 kW	RFW (XU10J2)	03.94 - 04.02	PS		AVX 10 x 715
				ALT	- AC	6 PK 698
				ALT	+ AC	6 PK 1100
				PS	FROM: 12.96	4 PK 755
				CAM		ZRK 1127
				CAM		KT 1522

#### 2.0 i 4x4

1998 ccm	80 kW	RFW (XU10J2)	08.96 - 04.02	PS		AVX 10 x 715
				ALT	- AC	6 PK 698
				ALT	+ AC	6 PK 1100
				PS	FROM: 12.96	4 PK 755
				CAM		ZRK 1127



## PEUGEOT

### BOXER Bus (230P)

#### 2.0 i 4x4

1998 ccm	80 kW	RFW (XU10J2)	08.96 - 04.02	CAM		KT 1522
----------	-------	--------------	---------------	-----	--	---------

#### 1.9 D

1905 ccm	51 kW	D9B (XUD9AU)	03.94 - 04.02	ALT	- AC	6 PK 730
				ALT	AMP: 120; MOD: D9B/DJY; + AC	6 PK 1153
				ALT	AMP: 80; MOD: D9B/DJY; + AC	6 PK 1145
				PS	FROM: 12.96	4 PK 755
				CAM		ZRK 1262
				CAM		KT 1040
				W-P; CAM	FROM: 02.97	KT 1040 W3
				W-P; CAM	UNTIL: 01.97	KT 1040 W1

#### 1.9 TD

1905 ccm	66 kW	DHY (XUD9TE)	08.94 - 04.02	PS		AVX 10 x 710
				PS	UNTIL: 12.96	AVX 10 x 715
				VAC-P		AVX 10 x 650
				ALT	- AC	6 PK 730
				ALT	AMP: 120; MOD: D8C/DHX; + AC	6 PK 1153
				ALT	AMP: 80; MOD: D8C/DHX; + AC	6 PK 1145
				PS	FROM: 12.96	4 PK 755
				CAM		ZRK 1262
				CAM		KT 1040
				W-P; CAM	FROM: 02.97	KT 1040 W3
				W-P; CAM	UNTIL: 01.97	KT 1040 W1

#### 1.9 TD

1905 ccm	68 kW	D8C (XUD9UTF)	03.94 - 04.02	PS		AVX 10 x 710
				PS	UNTIL: 12.96	AVX 10 x 715
				VAC-P		AVX 10 x 650
				ALT	- AC	6 PK 730
				PS	FROM: 12.96	4 PK 755
				CAM		ZRK 1262
				CAM		KT 1040
				W-P; CAM	FROM: 02.97	KT 1040 W3
				W-P; CAM	UNTIL: 01.97	KT 1040 W1

#### 1.9 TD 4x4

1905 ccm	68 kW	D8C (XUD9UTF)	07.96 - 04.02	PS		AVX 10 x 710
				PS	UNTIL: 12.96	AVX 10 x 715
				VAC-P		AVX 10 x 650
				ALT	- AC	6 PK 730
				PS	FROM: 12.96	4 PK 755
				CAM		ZRK 1262
				CAM		KT 1040
				W-P; CAM	FROM: 02.97	KT 1040 W3
				W-P; CAM	UNTIL: 01.97	KT 1040 W1

#### 2.5 D

2446 ccm	63 kW	T9A (DJ5)	08.94 - 04.02	AC-C		6 PK 913
				ALT	- PS	6 PK 800
				ALT	+ PS	6 PK 1010
				VAC-P	UNTIL: 11.95	6 PK 913
				W-P	FROM: 05.96	3 PK 866
				W-P	UNTIL: 05.96	4 PK 870
				CAM		ZRK 1141
				CAM		KT 1083

#### 2.5 D 4x4

2446 ccm	63 kW	T9A (DJ5)	07.96 - 04.02	AC-C		6 PK 913
				ALT	- PS	6 PK 800
				ALT	+ PS	6 PK 1010
				W-P		3 PK 866
				CAM		ZRK 1141
				CAM		KT 1083

#### 2.5 TD

2446 ccm	76 kW	T8A (DJ5T)	07.94 - 04.02	AC-C		6 PK 913
				ALT	- PS	6 PK 800
				ALT	+ PS	6 PK 1010
				VAC-P	UNTIL: 11.95	6 PK 913
				W-P	FROM: 05.96	3 PK 945
				W-P	UNTIL: 05.96	4 PK 950
				CAM		ZRK 1141



## PEUGEOT

### BOXER Bus (230P)

#### 2.5 TD

2446 ccm 76 kW T8A (DJ5T) 07.94 - 04.02 CAM KT 1083

#### 2.5 TD 4x4

2446 ccm 76 kW T8A (DJ5T) 07.96 - 04.02 AC-C 6 PK 913  
ALT - PS 6 PK 800  
ALT + PS 6 PK 1010  
W-P 3 PK 945  
CAM ZRK 1141  
CAM KT 1083

#### 2.5 TDI

2446 ccm 79 kW THX (DJ5TED) 01.97 - 04.02 AC-C 6 PK 913  
ALT - PS 6 PK 800  
ALT + PS 6 PK 1010  
W-P 3 PK 945  
CAM ZRK 1078  
CAM KT 1310

#### 2.5 TDI 4x4

2446 ccm 79 kW THX (DJ5TED) 01.97 - 04.02 AC-C 6 PK 913  
ALT FROM: 10.98 6 PK 800  
ALT FROM: 10.98; - PS 6 PK 1010  
W-P FROM: 10.98; + PS 3 PK 945  
CAM FROM: 10.98 ZRK 1078  
CAM KT 1310

#### 2.5 DT

2499 ccm 62 kW 10.97 - 11.01 AC-C 5 PK 1080  
ALT 6 PK 894

#### 2.8 HDi

2798 ccm 93 kW 8140.43S (F28DTCR) 10.00 - 11.01 AC-C 5 PK 1104  
ALT + AUTO-TM 6 PK 995  
ALT + MAN-TM 6 PK 950

#### 2.8 HDi

2798 ccm 94 kW 8140.43S (F28DTCR) 11.00 - 04.02 AC-C 5 PK 1104  
ALT + AUTO-TM 6 PK 995  
ALT + MAN-TM 6 PK 950  
CAM ZRK 1312  
CAM KT 1229

#### 2.8 HDi 4x4

2798 ccm 94 kW 8140.43S (F28DTCR) 10.00 - 04.02 AC-C 5 PK 1104  
ALT + AUTO-TM 6 PK 995  
ALT + MAN-TM 6 PK 950  
CAM ZRK 1312  
CAM KT 1229

### BOXER Kasten (230L)

#### 2.0 i

1998 ccm 80 kW RFW (XU10J2) 06.94 - 04.02 ALT - AC 6 PK 698  
ALT + AC 6 PK 1100  
PS FROM: 12.96 4 PK 755  
CAM ZRK 1127  
CAM KT 1522

#### 2.0 4x4

1998 ccm 80 kW 03.96 - 09.98 ALT - AC 6 PK 698  
ALT + AC 6 PK 1100  
PS FROM: 12.96 4 PK 755

#### 1.9 D

1905 ccm 50 kW DJY (XUD9A) 07.99 - 04.02 ALT - AC 6 PK 730  
ALT AMP: 120; MOD: D9B/DJY; + AC 6 PK 1153  
ALT AMP: 80; MOD: D9B/DJY; + AC 6 PK 1145  
PS 4 PK 755  
CAM ZRK 1262  
CAM KT 1040

#### 1.9 D

1905 ccm 51 kW D9B (XUD9AU) 03.94 - 04.02 PS UNTIL: 12.96 AVX 10 x 710  
ALT - AC 6 PK 730  
ALT AMP: 120; MOD: D9B/DJY; + AC 6 PK 1153  
ALT AMP: 80; MOD: D9B/DJY; + AC 6 PK 1145  
PS FROM: 12.96 4 PK 755



## PEUGEOT

### BOXER Kasten (230L)

<b>1.9 D</b>						
1905 ccm	51 kW	D9B (XUD9AU)	03.94 - 04.02	CAM CAM		ZRK 1262 KT 1040
<b>1.9 TD</b>						
1905 ccm	66 kW	XUD9TE	07.99 - 04.02	ALT ALT ALT PS CAM CAM	- AC AMP: 120; MOD: D8C/DHX; + AC AMP: 80; MOD: D8C/DHX; + AC	6 PK 730 6 PK 1153 6 PK 1145 4 PK 755 ZRK 1262 KT 1040
<b>1.9 TD</b>						
1905 ccm	68 kW	D8C (XUD9UTF)	03.94 - 04.02	PS ALT PS CAM CAM W-P; CAM	UNTIL: 12.96 - AC FROM: 12.96	AVX 10 x 650 AVX 10 x 715 6 PK 730 4 PK 755 ZRK 1262 KT 1040 KT 1040 W1
<b>1.9 DT 4x4</b>						
1905 ccm	66 kW	XUD9TE	03.96 - 09.98	ALT ALT ALT PS	- AC AMP: 120; MOD: D8C/DHX; + AC AMP: 80; MOD: D8C/DHX; + AC FROM: 12.96	6 PK 730 6 PK 1153 6 PK 1145 4 PK 755
<b>2.0 HDI</b>						
1997 ccm	62 kW	RHV (DW10UTD)	08.01 - 04.02	ALT ALT PS CAM CAM	- AC + AC	6 PK 1470 6 PK 1185 4 PK 755 ZRK 1352 KT 1327
<b>2.5 D</b>						
2446 ccm	63 kW	T9A (DJ5)	03.94 - 04.02	AC-C ALT ALT VAC-P W-P W-P CAM CAM	- PS + PS UNTIL: 11.95 FROM: 05.96 UNTIL: 05.96	6 PK 913 6 PK 800 6 PK 1010 6 PK 913 3 PK 866 4 PK 870 ZRK 1141 KT 1083
<b>2.5 D 4x4</b>						
2446 ccm	63 kW	T9A (DJ5)	07.99 - 04.02	AC-C ALT ALT W-P CAM CAM	- PS + PS	6 PK 913 6 PK 800 6 PK 1010 3 PK 866 ZRK 1141 KT 1083
<b>2.5 TD</b>						
2446 ccm	76 kW	T8A (DJ5T)	03.94 - 04.02	AC-C ALT ALT VAC-P W-P W-P CAM CAM	- PS + PS UNTIL: 11.95 FROM: 05.96 UNTIL: 05.96	6 PK 913 6 PK 800 6 PK 1010 6 PK 913 3 PK 945 4 PK 950 ZRK 1141 KT 1083
<b>2.5 TDI</b>						
2446 ccm	79 kW	THX (DJ5TED)	01.97 - 04.02	AC-C ALT ALT W-P CAM CAM	- PS + PS	6 PK 913 6 PK 800 6 PK 1010 3 PK 945 ZRK 1078 KT 1310
<b>2.5 TDI 4x4</b>						
2446 ccm	79 kW	THX (DJ5TED)	07.99 - 04.02	AC-C ALT ALT W-P CAM	- PS + PS	6 PK 913 6 PK 800 6 PK 1010 3 PK 945 ZRK 1078



## PEUGEOT

### BOXER Kasten (230L)

#### 2.5 TDI 4x4

2446 ccm 79 kW THX (DJ5TED) 07.99 - 04.02 CAM KT 1310

#### 2.5 DT

2499 ccm 62 kW 10.97 - 11.01 AC-C 5 PK 1080  
ALT 6 PK 894

#### 2.8 HDi

2798 ccm 93 kW 8140.43S (F28DTCR) 10.00 - 11.01 AC-C 5 PK 1104  
ALT + AUTO-TM 6 PK 995  
ALT + MAN-TM 6 PK 950

#### 2.8 HDi

2798 ccm 94 kW 8140.43S (F28DTCR) 11.00 - 04.02 AC-C 5 PK 1104  
ALT + AUTO-TM 6 PK 995  
ALT + MAN-TM 6 PK 950  
CAM ZRK 1312  
CAM KT 1229

#### 2.8 HDi 4x4

2798 ccm 94 kW 8140.43S (F28DTCR) 10.00 - 04.02 AC-C 5 PK 1104  
ALT + AUTO-TM 6 PK 995  
ALT + MAN-TM 6 PK 950  
CAM ZRK 1312  
CAM KT 1229

### BOXER Pritsche/Fahrgestell (ZCT\_)

#### 2.0 i

1998 ccm 80 kW RFW (XU10J2) 06.94 - 04.02 ALT - AC 6 PK 698  
ALT + AC 6 PK 1100  
PS FROM: 12.96 4 PK 755  
CAM ZRK 1127  
CAM KT 1522

#### 2.0

1998 ccm 81 kW RFL (XU10J2U) 12.01 - 04.02 ALT - AC 6 PK 698  
ALT + AC 6 PK 1100  
PS 4 PK 755

#### 1.9 TD

1905 ccm 66 kW DHY (XUD9TE) 12.98 - 04.02 ALT - AC 6 PK 730  
ALT AMP: 120; MOD: D8C/DHX; + AC 6 PK 1153  
ALT AMP: 80; MOD: D8C/DHX; + AC 6 PK 1145  
PS 4 PK 755  
CAM ZRK 1262  
CAM KT 1040  
W-P; CAM FROM PROD.-NO.: 07390 KT 1040 W3

#### 1.9 TD

1905 ccm 68 kW D8C (XUD9UTF) 07.96 - 04.02 ALT - AC 6 PK 730  
PS FROM: 12.96 4 PK 755  
CAM ZRK 1262  
CAM KT 1040  
W-P; CAM KT 1040 W1

#### 2.5 D

2446 ccm 63 kW T9A (DJ5) 03.94 - 04.02 AC-C 6 PK 913  
ALT - PS 6 PK 800  
ALT + PS 6 PK 1010  
VAC-P UNTIL: 11.95 6 PK 913  
W-P FROM: 05.96 3 PK 866  
W-P UNTIL: 05.96 4 PK 870  
CAM ZRK 1141  
CAM KT 1083

#### 2.5 D 4x4

2446 ccm 63 kW T9A (DJ5) 07.99 - 04.02 AC-C 6 PK 913  
ALT - PS 6 PK 800  
ALT + PS 6 PK 1010  
W-P 3 PK 866  
CAM ZRK 1141  
CAM KT 1083

#### 2.5 TD

2446 ccm 76 kW T8A (DJ5T) 03.94 - 04.02 AC-C 6 PK 913  
ALT - PS 6 PK 800  
ALT + PS 6 PK 1010



## PEUGEOT

### BOXER Pritsche/Fahrgestell (ZCT\_)

#### 2.5 TD

2446 ccm	76 kW	T8A (DJ5T)	03.94 - 04.02	VAC-P W-P W-P CAM CAM	UNTIL: 11.95 FROM: 05.96 UNTIL: 05.96	6 PK 913 3 PK 945 4 PK 950 ZRK 1141 KT 1083
----------	-------	------------	---------------	-----------------------------------	---	---

#### 2.5 TDI

2446 ccm	79 kW	THX (DJ5TED)	01.97 - 04.02	AC-C ALT ALT W-P CAM CAM	- PS + PS	6 PK 913 6 PK 800 6 PK 1010 3 PK 945 ZRK 1078 KT 1310
----------	-------	--------------	---------------	---	--------------	--

#### 2.5 TDI 4x4

2446 ccm	79 kW	THX (DJ5TED)	07.99 - 04.02	AC-C ALT ALT W-P CAM CAM	- PS + PS	6 PK 913 6 PK 800 6 PK 1010 3 PK 945 ZRK 1078 KT 1310
----------	-------	--------------	---------------	---	--------------	--

#### 2.8 HDi

2798 ccm	93 kW	8140.43S (F28DTCR)	10.00 - 11.01	AC-C ALT ALT	+ AUTO-TM + MAN-TM	5 PK 1104 6 PK 995 6 PK 950
----------	-------	--------------------	---------------	--------------------	-----------------------	-----------------------------------

#### 2.8 HDi

2798 ccm	94 kW	8140.43S (F28DTCR)	11.00 - 04.02	AC-C ALT ALT CAM CAM	+ AUTO-TM + MAN-TM	5 PK 1104 6 PK 995 6 PK 950 ZRK 1312 KT 1229
----------	-------	--------------------	---------------	----------------------------------	-----------------------	--

### BOXER Bus (244, Z\_)

#### 2.0

1998 ccm	81 kW	RFL (XU10J2U)	04.02 -	ALT ALT PS CAM CAM	- AC + AC	6 PK 698 6 PK 1100 4 PK 755 ZRK 1127 KT 1522
----------	-------	---------------	---------	--------------------------------	--------------	--

#### 2.0 HDi

1997 ccm	62 kW	RHV (DW10TD);RHV (DW10UTD)	04.02 -	ALT ALT ALT PS CAM CAM W-P; CAM	+ AC FROM: 05.04; - AC UNTIL: 05.04; - AC	6 PK 1185 6 PK 870 6 PK 1470 4 PK 755 ZRK 1352 KT 1327 KT 1327 W1
----------	-------	----------------------------	---------	---	---	---

#### 2.2 HDi

2179 ccm	74 kW	4HY (DW12UTED)	04.02 -	ALT ALT ALT PS CAM CAM CAM W-P; CAM W-P; CAM	+ AC FROM: 05.04; - AC UNTIL: 05.04; - AC FROM: 04.04 UNTIL: 04.04 FROM: 04.04 UNTIL: 04.04	6 PK 1185 6 PK 870 6 PK 1470 4 PK 755 ZRK 1456 KT 1417 KT 1353 KT 1417 W1 KT 1353 W1
----------	-------	----------------	---------	--	---	--

#### 2.8 HDi

2798 ccm	94 kW	8140.43S (F28DTCR)	04.02 -	AC-C ALT ALT CAM CAM	+ AUTO-TM + MAN-TM	5 PK 1104 6 PK 995 6 PK 950 ZRK 1312 KT 1229
----------	-------	--------------------	---------	----------------------------------	-----------------------	--

#### 2.8 HDi 4x4

2798 ccm	94 kW	8140.43S (F28DTCR)	04.02 -	AC-C ALT ALT	+ AUTO-TM + MAN-TM	5 PK 1104 6 PK 995 6 PK 950
----------	-------	--------------------	---------	--------------------	-----------------------	-----------------------------------



## PEUGEOT

### BOXER Bus (244, Z\_)

#### 2.8 HDi 4x4

2798 ccm	94 kW	8140.43S (F28DTCR)	04.02 -	CAM CAM		ZRK 1312 KT 1229
----------	-------	--------------------	---------	------------	--	---------------------

#### 2.8 HDi

2798 ccm	107 kW	8140.43N	04.04 -	AC-C ALT		5 PK 1104 6 PK 950
----------	--------	----------	---------	-------------	--	-----------------------

### BOXER Kasten (244)

#### 2.0

1998 ccm	81 kW	RFL (XU10J2U)	04.02 -	ALT	- AC	6 PK 698
				ALT	+ AC	6 PK 1100
				PS		4 PK 755
				CAM		ZRK 1127
				CAM		KT 1522

#### 2.0 HDi

1997 ccm	62 kW	RHV (DW10TD);RHV (DW10UTD)	04.02 -	ALT	+ AC	6 PK 1185
				ALT	FROM: 05.04; - AC	6 PK 870
				ALT	UNTIL: 05.04; - AC	6 PK 1470
				PS		4 PK 755
				CAM		ZRK 1352
				CAM		KT 1327
				W-P; CAM		KT 1327 W1

#### 2.2 HDi

2179 ccm	74 kW	4HY (DW12UTED)	04.02 -	ALT	+ AC	6 PK 1185
				ALT	FROM: 05.04; - AC	6 PK 870
				ALT	UNTIL: 05.04; - AC	6 PK 1470
				PS		4 PK 755
				CAM		ZRK 1456
				CAM	FROM: 04.04	KT 1417
				CAM	UNTIL: 04.04	KT 1353
				W-P; CAM	FROM: 04.04	KT 1417 W1
				W-P; CAM	UNTIL: 04.04	KT 1353 W1

#### 2.8 HDi

2798 ccm	94 kW	8140.43S (F28DTCR)	04.02 -	AC-C		5 PK 1104
				ALT	+ AUTO-TM	6 PK 995
				ALT	+ MAN-TM	6 PK 950
				CAM		ZRK 1312
				CAM		KT 1229

#### 2.8 HDi 4x4

2798 ccm	94 kW	8140.43S (F28DTCR)	04.02 -	AC-C		5 PK 1104
				ALT	+ AUTO-TM	6 PK 995
				ALT	+ MAN-TM	6 PK 950
				CAM		ZRK 1312
				CAM		KT 1229

#### 2.8 HDi

2798 ccm	107 kW	8140.43N	04.04 -	AC-C		5 PK 1104
				ALT		6 PK 950
				CAM		ZRK 1312
				CAM		KT 1229

### BOXER Pritsche/Fahrgestell (244)

#### 2.0 HDi

1997 ccm	62 kW	RHV (DW10TD);RHV (DW10UTD)	04.02 -	ALT	FROM: 05.04; MTR-CODE: DW10TD; - AC	6 PK 870
				ALT	MTR-CODE: DW10TD; + AC	6 PK 1185
				ALT	UNTIL: 05.04; MTR-CODE: DW10TD; - AC	6 PK 1470
				PS	MTR-CODE: DW10TD	4 PK 755
				CAM		ZRK 1352
				CAM		KT 1327
				W-P; CAM		KT 1327 W1

#### 2.2 HDi

2179 ccm	74 kW	4HY (DW12UTED)	04.02 -	ALT	+ AC	6 PK 1185
				ALT	FROM: 05.04; - AC	6 PK 870
				ALT	UNTIL: 05.04; - AC	6 PK 1470
				PS		4 PK 755
				CAM		ZRK 1456
				CAM	FROM: 04.04	KT 1417



## PEUGEOT

### BOXER Pritsche/Fahrgestell (244)

<b>2.2 HDi</b>						
2179 ccm	74 kW	4HY (DW12UTED)	04.02 -	CAM W-P; CAM W-P; CAM	UNTIL: 04.04 FROM: 04.04 UNTIL: 04.04	KT 1353 KT 1417 W1 KT 1353 W1
<b>2.8 HDi</b>						
2798 ccm	94 kW	8140.43S (F28DTCR)	04.02 -	AC-C ALT ALT CAM CAM	+ AUTO-TM + MAN-TM	5 PK 1104 6 PK 995 6 PK 950 ZRK 1312 KT 1229
<b>2.8 HDi 4x4</b>						
2798 ccm	94 kW	8140.43S (F28DTCR)	04.02 -	AC-C ALT ALT CAM CAM	+ AUTO-TM + MAN-TM	5 PK 1104 6 PK 995 6 PK 950 ZRK 1312 KT 1229
<b>2.8 HDi</b>						
2798 ccm	107 kW	8140.43N	04.04 -	AC-C ALT CAM CAM		5 PK 1104 6 PK 950 ZRK 1312 KT 1229

### BOXER Bus

<b>2.2 HDi 100</b>						
2198 ccm	74 kW	4HV (P22DTE)	04.06 -	ALT ALT PS	- AC FROM: 02.07; + AC	6 EPK 873 6 PK 1670 4 EPK 922
<b>2.2 HDi 120</b>						
2198 ccm	88 kW	4HU (P22DTE)	04.06 -	ALT ALT PS	- AC + AC	6 EPK 873 6 PK 1670 4 EPK 922
<b>3.0 HDi 145</b>						
2999 ccm	107 kW		04.10 -	ALT		6 PK 1165
<b>3.0 HDi 160</b>						
2999 ccm	116 kW	F1CE0481D (FG30DT)	04.06 -	AC-C ALT		4 EPK 1102 6 PK 1165

### BOXER Kasten

<b>2.2 HDi 100</b>						
2198 ccm	74 kW	4HV (P22DTE)	04.06 -	ALT ALT PS	- AC + AC	6 EPK 873 6 PK 1670 4 EPK 922
<b>2.2 HDi 120</b>						
2198 ccm	88 kW	4HU (P22DTE)	04.06 -	ALT ALT PS	- AC + AC	6 EPK 873 6 PK 1670 4 EPK 922
<b>3.0 D</b>						
2998 ccm	115 kW		07.06 -	ALT		6 PK 1165
<b>3.0 HDi 145</b>						
2999 ccm	107 kW		04.10 -	ALT		6 PK 1165
<b>3.0 HDi 160</b>						
2999 ccm	116 kW	F1CE0481D (FG30DT)	04.06 -	AC-C ALT		4 EPK 1102 6 PK 1165

### BOXER Pritsche/Fahrgestell

<b>2.2 HDi 100</b>						
2198 ccm	74 kW	4HV (P22DTE)	04.06 -	ALT ALT PS	- AC FROM: 02.07; MTR-CODE: 22DT; + AC	6 EPK 873 6 PK 1670 4 EPK 922
<b>2.2 HDi 120</b>						
2198 ccm	88 kW	4HU (P22DTE)	04.06 -	ALT ALT PS	- AC FROM: 02.07; MTR-CODE: 22DT; + AC	6 EPK 873 6 PK 1670 4 EPK 922
<b>3.0 D</b>						
2998 ccm	115 kW		02.07 -	ALT	MTR-CODE: F30DT	6 PK 1165
<b>3.0 HDi 145</b>						
2999 ccm	107 kW		04.10 -	ALT		6 PK 1165





## PEUGEOT

### BOXER Pritsche/Fahrgestell

#### 3.0 HDi 160

2999 ccm	116 kW	F1CE0481D (FG30DT)	04.06 -	AC-C ALT	4 EPK 1102 6 PK 1165
----------	--------	--------------------	---------	-------------	-------------------------

## RENAULT

### TRAFIC Bus (TXW)

#### 1.7

1721 ccm	50 kW	F1N 724	08.92 - 08.94	ALT CAM CAM	MOD: T1100	6 PK 850 ZRK 1276 KT 1010
----------	-------	---------	---------------	-------------------	------------	---------------------------------

#### 2.0

1995 ccm	59 kW	J5R 726	05.89 - 08.90	ALT CAM		AVX 10 x 1000 ZRK 1129
----------	-------	---------	---------------	------------	--	---------------------------

#### 2.2

2165 ccm	70 kW	J7T 780	05.89 - 06.94	ALT PS CAM CAM CAM	FROM: 01.91 UNTIL: 12.90	AVX 11,9 x 1010 AVX 11,9 x 758 ZRK 1131 KT 1066 KT 1264
----------	-------	---------	---------------	--------------------------------	-----------------------------	---

#### 2.2

2165 ccm	74 kW	J7T 600	06.94 - 10.97	ALT PS CAM CAM		AVX 11,9 x 1010 AVX 11,9 x 758 ZRK 1131 KT 1066
----------	-------	---------	---------------	-------------------------	--	--

#### 1.9 D

1870 ccm	44 kW	F8Q 606	06.97 - 03.01	ALT	FROM: 03.00; MTR-CODE: F8Q600;F8Q606; MOD: T900	6 PK 1145
				ALT	FROM: 05.98; MTR-CODE: F8Q600;F8Q606; MOD: T1000	6 PK 1138
				ALT	FROM: 05.98; MTR-CODE: F8Q600;F8Q606; MOD: T1100	6 PK 1138
				ALT	FROM: 05.98; UNTIL: 03.00; MTR-CODE: F8Q600;F8Q606; MOD: T900	6 PK 1138
				CAM		ZRK 1195
				CAM		KT 1131
				CAM		KT 1343

#### 2.1 D

2068 ccm	43 kW	852 720;852 750	05.89 - 06.94	ALT CAM CAM		AVX 11,9 x 1010 ZRK 1261 KT 1038
----------	-------	-----------------	---------------	-------------------	--	--

#### 2.1 D

2068 ccm	47 kW	J8S 620;J8S 758	06.94 - 10.97	ALT CAM CAM		AVX 11,9 x 1010 ZRK 1261 KT 1038
----------	-------	-----------------	---------------	-------------------	--	--

#### 2.5 D

2499 ccm	55 kW	8140.67.2500;8140.67.2550;8140 .67.2580;S8U 750;S8U 752;S8U 758	05.89 - 03.01	ALT		AVX 10 x 950
				CAM	FROM: 10.90; FROM MTR-NO: 1307401	ZRK 1312
				CAM	UNTIL: 09.90; UNTIL MTR-NO: 1307400	ZRK 1100
				CAM	FROM MTR-NO: 1307401	KT 1229
				CAM	UNTIL MTR-NO: 1307400	KT 1091

#### 2.5 D 4x4

2499 ccm	55 kW	8140.67.2500;8140.67.2550;8140 .67.2580;S8U 750;S8U 752;S8U 758	08.89 - 03.01	ALT; W-P		AVX 10 x 950
				CAM	FROM: 10.90; FROM MTR-NO: 1307401	ZRK 1312
				CAM	UNTIL: 09.90; UNTIL MTR-NO: 1307400	ZRK 1100
				CAM	FROM MTR-NO: 1307401	KT 1229
				CAM	UNTIL MTR-NO: 1307400	KT 1091

### TRAFIC Kasten (TXX)

#### 1.7

1721 ccm	50 kW	F1N 720	08.92 - 08.94	ALT ALT CAM CAM	MTR-CODE: F1N720;F1N724; MOD: T1100 MTR-CODE: F1N724; MOD: T900	6 PK 850 6 PK 850 ZRK 1276 KT 1010
----------	-------	---------	---------------	--------------------------	--	---



## RENAULT

### TRAFIC Kasten (TXX)

<b>2.0</b>						
1995 ccm	59 kW	J5R 716	05.89 - 08.90	ALT CAM		AVX 10 x 1000 ZRK 1129
<b>2.2</b>						
2165 ccm	70 kW	J7T 780	05.89 - 06.94	ALT PS CAM CAM CAM	FROM: 01.91 UNTIL: 12.90	AVX 10 x 1000 AVX 11,9 x 758 ZRK 1131 KT 1066 KT 1264
<b>2.2 4x4</b>						
2165 ccm	70 kW	J7T 780	05.89 - 06.94	CAM CAM	FROM: 01.91	ZRK 1131 KT 1065
<b>2.2</b>						
2165 ccm	74 kW	J7T 600	06.94 - 10.97	ALT PS CAM CAM		AVX 11,9 x 1010 AVX 11,9 x 758 ZRK 1131 KT 1066
<b>2.2 4x4</b>						
2165 ccm	74 kW	J7T 600	06.94 - 10.97	CAM CAM		ZRK 1131 KT 1066
<b>1.9 D</b>						
1870 ccm	44 kW	F8Q 606	06.97 - 03.01	ALT ALT ALT CAM CAM CAM	FROM: 03.00; MTR-CODE: F8Q600;F8Q606; MOD: T900 FROM: 05.98; MTR-CODE: F8Q600;F8Q606; MOD: T1000 FROM: 05.98; UNTIL: 03.00; MTR-CODE: F8Q600;F8Q606; MOD: T900	6 PK 1145 6 PK 1138 6 PK 1138 ZRK 1195 KT 1131 KT 1343
<b>2.1 D</b>						
2068 ccm	43 kW	852 750	05.89 - 06.94	ALT CAM CAM		AVX 11,9 x 1010 ZRK 1261 KT 1038
<b>2.1 D</b>						
2068 ccm	47 kW	J8S 620;J8S 758	06.94 - 10.97	ALT CAM CAM		AVX 11,9 x 1010 ZRK 1261 KT 1038
<b>2.5 D</b>						
2499 ccm	55 kW	8140.67.2500;8140.67.2550;8140.67.2580;S8U 750;S8U 752;S8U 758	05.89 - 03.01	ALT CAM CAM CAM CAM	FROM: 10.90; FROM MTR-NO: 1307401 UNTIL: 09.90; UNTIL MTR-NO: 1307400 FROM MTR-NO: 1307401 UNTIL MTR-NO: 1307400	AVX 10 x 950 ZRK 1312 ZRK 1100 KT 1229 KT 1091
<b>2.5 D 4x4</b>						
2499 ccm	55 kW	8140.67.2500;8140.67.2580;S8U 750;S8U 752	05.89 - 03.01	CAM CAM CAM CAM	FROM: 10.90; FROM MTR-NO: 1307401 UNTIL: 09.90; UNTIL MTR-NO: 1307400 FROM MTR-NO: 1307401 UNTIL MTR-NO: 1307400	ZRK 1312 ZRK 1100 KT 1229 KT 1091

### TRAFIC Pritsche/Fahrgestell (PXX)

<b>1.7</b>						
1721 ccm	50 kW	F1N 722	05.89 - 08.94	CAM CAM		ZRK 1276 KT 1010
<b>2.0 [RWD]</b>						
1995 ccm	59 kW	J5R 726	05.89 - 10.97	CAM		ZRK 1129
<b>2.1 D [RWD]</b>						
2068 ccm	43 kW	852 720	05.89 - 06.94	CAM CAM		ZRK 1261 KT 1038
<b>2.1 D [RWD]</b>						
2068 ccm	47 kW	J8S 620;J8S 758	06.94 - 10.97	CAM CAM		ZRK 1261 KT 1038
<b>2.5 D</b>						
2445 ccm	51 kW	8140.61.240;S8U 720;S8U 722	05.89 - 03.01	CAM CAM	FROM: 10.90; FROM MTR-NO: 1307401 UNTIL: 09.90; UNTIL MTR-NO: 1307400	ZRK 1312 ZRK 1100

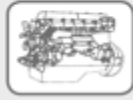

## RENAULT

### TRAFIC Pritsche/Fahrgestell (PXX)

#### 2.5 D

2445 ccm	51 kW	8140.61.240;S8U 720;S8U 722	05.89 - 03.01	CAM CAM	FROM MTR-NO: 1307401 UNTIL MTR-NO: 1307400	KT 1229 KT 1091
----------	-------	-----------------------------	---------------	------------	---	--------------------

### TRAFIC II Bus (JL)

#### 2.0 16V

1998 ccm	86 kW	F4R 820	08.06 -	ALT ALT CAM	- AC + AC	5 PK 1125 6 PK 1795 ZRK 1475
----------	-------	---------	---------	-------------------	--------------	------------------------------------

#### 2.0 (JL0A)

1998 ccm	88 kW	F4R 720;F4R 722	03.01 -	ALT ALT CAM	- AC + AC	5 PK 1125 6 PK 1795 ZRK 1475
----------	-------	-----------------	---------	-------------------	--------------	------------------------------------

#### 1.9 dCi

1870 ccm	59 kW	F9Q 762	04.01 -	CAM CAM CAM	MTR-CODE: F9Q760;F9Q762 MTR-CODE: F9Q760;F9Q762 MTR-CODE: F9Q760;F9Q762	ZRK 1067 KT 1434 KT 1434 W1
----------	-------	---------	---------	-------------------	---	-----------------------------------

#### 1.9 dCi 80 (JL0B)

1870 ccm	60 kW	F9Q 762	03.01 -	ALT ALT ALT CAM CAM CAM	- AC; - ENG-PTO - AC; + ENG-PTO + AC MTR-CODE: F9Q760;F9Q762 MTR-CODE: F9Q760;F9Q762 MTR-CODE: F9Q760;F9Q762	5 PK 1125 6 PK 1830 6 PK 1795 ZRK 1067 KT 1434 KT 1434 W1
----------	-------	---------	---------	--	---	--

#### 1.9 dCi 100 (JL0C)

1870 ccm	74 kW	F9Q 760	03.01 -	ALT ALT ALT CAM CAM CAM	- AC; - ENG-PTO - AC; + ENG-PTO + AC MTR-CODE: F9Q760;F9Q762 MTR-CODE: F9Q760;F9Q762 MTR-CODE: F9Q760;F9Q762	5 PK 1125 6 PK 1830 6 PK 1795 ZRK 1067 KT 1434 KT 1434 W1
----------	-------	---------	---------	--	---	--

#### 2.0 dCi 90 (JL0H)

1995 ccm	66 kW	M9R 782	08.06 -	ALT	+ AC	7 PK 1970
----------	-------	---------	---------	-----	------	-----------

#### 2.0 dCi 115 (JL0H)

1995 ccm	84 kW	M9R 780;M9R 782;M9R 786	08.06 -	ALT	+ AC	7 PK 1970
----------	-------	-------------------------	---------	-----	------	-----------

#### 2.5 DTi

2463 ccm	99 kW	G9U 730	03.03 -	ALT ALT ALT CAM CAM	- AC; - ENG-PTO - AC; + ENG-PTO + AC	6 PK 1145 6 PK 1795 6 PK 1795 ZRK 1462 KT 1392
----------	-------	---------	---------	---------------------------------	--	--

#### 2.5 dCi 135 (JL0D)

2464 ccm	99 kW	G9U 730	05.03 -	ALT ALT ALT CAM CAM	- AC; - ENG-PTO - AC; + ENG-PTO + AC	6 PK 1145 6 PK 1795 6 PK 1795 ZRK 1462 KT 1392
----------	-------	---------	---------	---------------------------------	--	--

#### 2.5 dCi 145 (JL0J)

2464 ccm	107 kW	G9U 630	08.06 -	ALT ALT ALT CAM CAM	- AC; - ENG-PTO + AC OE-NO.: 8200833558; - AC; + ENG-PTO	7 PK 1110 7 PK 1793 7 PK 1793 ZRK 1462 KT 1392
----------	--------	---------	---------	---------------------------------	--	--

### TRAFIC II Kasten (FL)

#### 2.0 16V

1998 ccm	86 kW	F4R 820	08.06 -	ALT ALT CAM	- AC + AC	5 PK 1125 6 PK 1795 ZRK 1475
----------	-------	---------	---------	-------------------	--------------	------------------------------------

#### 2.0 (FL0A)

1998 ccm	88 kW	F4R 720;F4R 722	03.01 -	ALT ALT CAM	- AC + AC	5 PK 1125 6 PK 1795 ZRK 1475
----------	-------	-----------------	---------	-------------------	--------------	------------------------------------

#### 1.9 dCi 80 (FL0B)

1870 ccm	60 kW	F9Q 760;F9Q 762	03.01 -	ALT ALT ALT	- AC; - ENG-PTO - AC; + ENG-PTO + AC	5 PK 1125 6 PK 1830 6 PK 1795
----------	-------	-----------------	---------	-------------------	--	-------------------------------------



## RENAULT

### TRAFIC II Kasten (FL)

#### 1.9 dCi 80 (FL0B)

1870 ccm	60 kW	F9Q 760;F9Q 762	03.01 -	CAM	MTR-CODE: F9Q760;F9Q762	ZRK 1067
				CAM	MTR-CODE: F9Q760;F9Q762	KT 1434
				CAM	MTR-CODE: F9Q760;F9Q762	KT 1434 W1

#### 1.9 dCi 100 (FL0C)

1870 ccm	74 kW	F9Q 760	03.01 -	ALT	- AC; - ENG-PTO	5 PK 1125
				ALT	- AC; + ENG-PTO	6 PK 1830
				ALT	+ AC	6 PK 1795
				CAM	MTR-CODE: F9Q760;F9Q762	ZRK 1067
				CAM	MTR-CODE: F9Q760;F9Q762	KT 1434
				CAM	MTR-CODE: F9Q760;F9Q762	KT 1434 W1

#### 2.0 dCi 90 (FL0H)

1995 ccm	66 kW	M9R 780;M9R 782	08.06 -	ALT	+ AC	7 PK 1970
----------	-------	-----------------	---------	-----	------	-----------

#### 2.0 dCi 115 (FL0H)

1995 ccm	84 kW	M9R 780;M9R 782;M9R 786	08.06 -	ALT	+ AC	7 PK 1970
----------	-------	-------------------------	---------	-----	------	-----------

#### 2.5 DTi

2463 ccm	99 kW	G9U 730	03.03 -	ALT	- AC; - ENG-PTO	6 PK 1145
				ALT	- AC; + ENG-PTO	6 PK 1795
				ALT	+ AC	6 PK 1795
				CAM		ZRK 1462
				CAM		KT 1392

#### 2.5 dCi 135 (FL0D)

2464 ccm	99 kW	G9U 730	05.03 -	ALT	- AC; - ENG-PTO	6 PK 1145
				ALT	- AC; + ENG-PTO	6 PK 1795
				ALT	+ AC	6 PK 1795
				CAM		ZRK 1462
				CAM		KT 1392

#### 2.5 dCi 145 (FL0J)

2464 ccm	107 kW	G9U 630	08.06 -	ALT	- AC; - ENG-PTO	7 PK 1110
				ALT	+ AC	7 PK 1793
				ALT	OE-NO.: 8200833558; - AC; + ENG-PTO	7 PK 1793
				CAM		ZRK 1462
				CAM		KT 1392

### TRAFIC II Pritsche/Fahrgestell (EL)

#### 2.0 (ELOA)

1998 ccm	88 kW	F4R 720	03.01 -	ALT	- AC	5 PK 1125
				ALT	+ AC	6 PK 1795
				CAM		ZRK 1475

#### 1.9 dCi 80 (ELOB)

1870 ccm	60 kW	F9Q 762	03.01 -	ALT	- AC; - ENG-PTO	5 PK 1125
				ALT	- AC; + ENG-PTO	6 PK 1830
				ALT	+ AC	6 PK 1795
				CAM	MTR-CODE: F9Q760;F9Q762	ZRK 1067
				CAM	MTR-CODE: F9Q760;F9Q762	KT 1434
				CAM	MTR-CODE: F9Q760;F9Q762	KT 1434 W1

#### 1.9 dCi 100 (ELOC)

1870 ccm	74 kW	F9Q 760	03.01 -	ALT	- AC; - ENG-PTO	5 PK 1125
				ALT	- AC; + ENG-PTO	6 PK 1830
				ALT	+ AC	6 PK 1795
				CAM	MTR-CODE: F9Q760;F9Q762	ZRK 1067
				CAM	MTR-CODE: F9Q760;F9Q762	KT 1434
				CAM	MTR-CODE: F9Q760;F9Q762	KT 1434 W1

#### 2.0 dCi 90 (EL0H)

1995 ccm	66 kW	M9R 780;M9R 782	08.06 -	ALT	+ AC	7 PK 1970
----------	-------	-----------------	---------	-----	------	-----------

#### 2.0 dCi 115 (EL0H)

1995 ccm	84 kW	M9R 780;M9R 782;M9R 786	08.06 -	ALT	+ AC	7 PK 1970
----------	-------	-------------------------	---------	-----	------	-----------

#### 2.5 dCi

2463 ccm	84 kW	G9U 630	08.07 -	ALT	- AC; - ENG-PTO	7 PK 1110
				ALT	+ AC	7 PK 1793
				ALT	OE-NO.: 8200833558; - AC; + ENG-PTO	7 PK 1793

#### 2.5 dCi 135 (ELOD)

2463 ccm	99 kW	G9U 730	03.01 -	ALT	FROM: 03.03; - AC; - ENG-PTO	6 PK 1145
				ALT	FROM: 03.03; - AC; + ENG-PTO	6 PK 1795
				ALT	FROM: 03.03; + AC	6 PK 1795
				CAM		ZRK 1462
				CAM		KT 1392

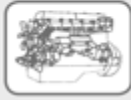

## RENAULT

### TRAFIC II Pritsche/Fahrgestell (EL)

#### 2.5 dCi 145 (EL0J)

2464 ccm	107 kW	G9U 630	08.06 -	ALT	- AC; - ENG-PTO	7 PK 1110
				ALT	+ AC	7 PK 1793
				ALT	OE-NO.: 8200833558; - AC; + ENG-PTO	7 PK 1793
				CAM		ZRK 1462
				CAM		KT 1392

### MASTER I Bus (T\_\_)

#### 28-35 2.0

1995 ccm	58 kW	J5R 718	10.86 - 07.98	CAM		ZRK 1129
				CAM	FROM: 07.89	KT 1065

#### 28-35 2.0

1995 ccm	59 kW	829 731	08.80 - 09.86	CAM	FROM: 07.84	ZRK 1129
				CAM	UNTIL: 06.84	ZRK 1051
				CAM	UNTIL: 06.84	KT 1088

#### 30 2,2

2165 ccm	67 kW	J7T 782;J7T 788	08.80 - 07.98	CAM		ZRK 1131
				CAM	FROM: 01.91	KT 1066
				CAM	UNTIL: 12.90	KT 1264

#### 28-35 2.1 D

2068 ccm	44 kW	J8S 330	08.80 - 07.98	CAM		ZRK 1261
				CAM		KT 1038

#### 28-35 2.4 D

2445 ccm	52 kW	8140.61.2300;S8U 731	08.80 - 08.89	CAM		ZRK 1100
				CAM		KT 1091

#### 28-35 2.5 D

2499 ccm	55 kW	8140.67.2510;S8U 742	08.89 - 07.98	CAM	FROM: 10.90; FROM MTR-NO: 1307401	ZRK 1312
				CAM	UNTIL: 09.90; UNTIL MTR-NO: 1307400	ZRK 1100
				CAM	FROM: 10.90	KT 1229
				CAM	UNTIL: 09.90	KT 1091

#### 35 2,5 TD

2499 ccm	69 kW	8140.27.2500;8140.27.2510;S9U 714	08.89 - 07.98	CAM	FROM MTR-NO: 1307401	ZRK 1316
				CAM	UNTIL MTR-NO: 1307400	ZRK 1102
				CAM	FROM MTR-NO: 1307401	KT 1217
				CAM	UNTIL MTR-NO: 1307400	KT 1098

#### 28-35 2,5 TD

2499 ccm	72 kW	8140.27.2580;S9U 702	08.89 - 07.98	CAM	FROM MTR-NO: 1307401	ZRK 1316
				CAM	UNTIL MTR-NO: 1307400	ZRK 1102
				CAM	FROM MTR-NO: 1307401	KT 1217
				CAM	UNTIL MTR-NO: 1307400	KT 1098

### MASTER I Kasten (T\_\_)

#### 28-35 2.0

1995 ccm	58 kW	J5R 718	10.86 - 07.98	CAM		ZRK 1129
				CAM	FROM: 07.89	KT 1065

#### 28-35 2.0

1995 ccm	59 kW	829 731	08.80 - 10.86	CAM	FROM: 07.84	ZRK 1129
				CAM	UNTIL: 06.84	ZRK 1051
				CAM	UNTIL: 06.84	KT 1088

#### 30 2,2

2165 ccm	67 kW	J7T 782;J7T 788	08.80 - 07.98	CAM		ZRK 1131
				CAM	FROM: 01.91	KT 1066
				CAM	UNTIL: 12.90	KT 1264

#### 28-35 2.1 D

2068 ccm	44 kW	J8S 330	08.80 - 07.98	CAM		ZRK 1261
				CAM		KT 1038

#### 28-35 2.4 D

2445 ccm	52 kW	8140.61.2300;S8U 731	08.80 - 08.89	CAM		ZRK 1100
				CAM		KT 1091

#### 28-35 2,5 D

2499 ccm	55 kW	8140.67.2510;S8U 742	08.89 - 07.98	CAM	FROM: 10.90; FROM MTR-NO: 1307401	ZRK 1312
				CAM	UNTIL: 09.90; UNTIL MTR-NO: 1307400	ZRK 1100
				CAM	FROM: 10.90	KT 1229
				CAM	UNTIL: 09.90	KT 1091



## RENAULT

### MASTER I Kasten (T\_\_)

#### 35 2,5 TD

2499 ccm	69 kW	8140.27.2500;8140.27.2510;S9U 714	08.89 - 07.98	CAM	FROM MTR-NO: 1307401	ZRK 1316
				CAM	UNTIL MTR-NO: 1307400	ZRK 1102
				CAM	FROM MTR-NO: 1307401	KT 1217
				CAM	UNTIL MTR-NO: 1307400	KT 1098

#### 28-35 2,5 TD

2499 ccm	72 kW	8140.27.2580;S9U 702	08.89 - 07.98	CAM	FROM MTR-NO: 1307401	ZRK 1316
				CAM	UNTIL MTR-NO: 1307400	ZRK 1102
				CAM	FROM MTR-NO: 1307401	KT 1217
				CAM	UNTIL MTR-NO: 1307400	KT 1098

### MASTER I Pritsche/Fahrgestell (P\_\_)

#### 28-35 2.0

1995 ccm	58 kW	J5R 728	10.86 - 07.98	CAM		ZRK 1129
				CAM	FROM: 07.89	KT 1065

#### 28-35 2.0

1995 ccm	59 kW	829 730	10.82 - 09.86	CAM	FROM: 07.84	ZRK 1129
				CAM	UNTIL: 06.84	ZRK 1051
				CAM	UNTIL: 06.84	KT 1088

#### 28-35 2.5 D

2445 ccm	52 kW	8140.61.2300;S8U 731	09.80 - 07.98	CAM		ZRK 1100
				CAM		KT 1091

### MASTER II Bus (JD)

#### 1.9 dTi

1870 ccm	59 kW	F9Q 770	09.00 -	ALT		6 PK 1130
				CAM		ZRK 1069
				CAM		KT 1493

#### 1.9 dCi 80

1870 ccm	60 kW	F9Q 772;F9Q 774	11.01 -	CAM		ZRK 1067
				CAM		KT 1434
				CAM	MTR-CODE: F9Q752	KT 1434 W1

#### 2.2 dCi 90

2188 ccm	66 kW	G9T 720;G9T 722;G9T 750	09.00 -	ALT	FROM: 11.04; MTR-CODE: G9T750; - AC; - ENG-PTO	7 PK 1105
				ALT	MTR-CODE: G9T720; - AC; - ENG-PTO	6 PK 1145
				ALT	MTR-CODE: G9T720; OE-NO.: 7700109477; - AC; + ENG-PTO	6 PK 1795
				ALT	MTR-CODE: G9T720; OE-NO.: 7700109477; + AC	6 PK 1795
				ALT	MTR-CODE: G9T720; OE-NO.: 8200466868; - AC; + ENG-PTO	6 PK 1840
				ALT	MTR-CODE: G9T720; OE-NO.: 8200466868; + AC	6 PK 1840
				ALT	MTR-CODE: G9T720;G9T722; - AC; - ENG-PTO	6 PK 1145
				ALT	MTR-CODE: G9T720;G9T722; OE-NO.: 7700109477; - AC; + ENG-PTO	6 PK 1795
				ALT	MTR-CODE: G9T720;G9T722; OE-NO.: 7700109477; + AC	6 PK 1795
				ALT	MTR-CODE: G9T720;G9T722; OE-NO.: 8200466868; - AC; + ENG-PTO	6 PK 1840
				ALT	MTR-CODE: G9T720;G9T722; OE-NO.: 8200466868; + AC	6 PK 1840
				ALT	MTR-CODE: G9T722; - AC; - ENG-PTO	6 PK 1145
				ALT	MTR-CODE: G9T722; OE-NO.: 7700109477; - AC; + ENG-PTO	6 PK 1795
				ALT	MTR-CODE: G9T722; OE-NO.: 7700109477; + AC	6 PK 1795
				ALT	MTR-CODE: G9T722; OE-NO.: 8200466868; - AC; + ENG-PTO	6 PK 1840
				ALT	MTR-CODE: G9T722; OE-NO.: 8200466868; + AC	6 PK 1840
				ALT	MTR-CODE: G9T750; + AC; - ENG-PTO	7 PK 1793
				ALT	MTR-CODE: G9T750; OE-NO.: 7700109477; - AC; + ENG-PTO	6 PK 1795
				ALT	MTR-CODE: G9T750; OE-NO.: 8200466868; - AC; + ENG-PTO	6 PK 1840
				ALT	UNTIL: 11.04; MTR-CODE: G9T750; - AC; - ENG-PTO	7 PK 1145
				CAM		ZRK 1462



## RENAULT

### MASTER II Bus (JD)

#### 2.2 dCi 90

2188 ccm 66 kW G9T 720;G9T 722;G9T 750 09.00 - CAM KT 1392

#### 2.5 dCi 100 (JDCV)

2463 ccm 73 kW G9U 754 10.03 - CAM ZRK 1462  
CAM KT 1392

#### 2.5 dCi

2464 ccm 74 kW G9U 754 08.06 - CAM ZRK 1462  
CAM KT 1392

#### 2.5 dCi 120

2463 ccm 84 kW G9U 720;G9U 754 10.01 - CAM ZRK 1462  
CAM KT 1392

#### 2.5 dCi

2464 ccm 88 kW G9U 650 08.06 - ALT MTR-CODE: G9U632; - AC; - ENG-PTO 7 PK 1110  
ALT MTR-CODE: G9U632; + AC 7 PK 1793  
ALT MTR-CODE: G9U632; OE-NO.: 8200833558; - AC; + ENG-PTO 7 PK 1793  
ALT MTR-CODE: G9U632;G9U650; - AC; - ENG-PTO 7 PK 1110  
ALT MTR-CODE: G9U632;G9U650; + AC 7 PK 1793  
ALT MTR-CODE: G9U632;G9U650; OE-NO.: 8200833558; - AC; + ENG-PTO 7 PK 1793  
ALT MTR-CODE: G9U650; - AC; - ENG-PTO 7 PK 1110  
ALT MTR-CODE: G9U650; + AC 7 PK 1793  
ALT MTR-CODE: G9U650; OE-NO.: 8200833558; - AC; + ENG-PTO 7 PK 1793  
ALT MTR-CODE: G9U720;G9U724; - AC; - ENG-PTO 6 PK 1145  
ALT MTR-CODE: G9U720;G9U724; + AC 6 PK 1840  
ALT MTR-CODE: G9U720;G9U724; OE-NO.: 8200466868; - AC; + ENG-PTO 6 PK 1840  
ALT MTR-CODE: G9U750; - AC; - ENG-PTO 7 PK 1105  
ALT MTR-CODE: G9U750; + AC 7 PK 1793  
ALT MTR-CODE: G9U750; OE-NO.: 8200466868; - AC; + ENG-PTO 6 PK 1840  
ALT MTR-CODE: G9U750;G9U754; + AC 7 PK 1793  
CAM ZRK 1462  
CAM KT 1392

#### 2.5 dCi

2464 ccm 107 kW G9U 632 08.06 - ALT MTR-CODE: G9U720;G9U724; - AC; - ENG-PTO 6 PK 1145  
ALT MTR-CODE: G9U720;G9U724; + AC 6 PK 1840  
ALT MTR-CODE: G9U720;G9U724; OE-NO.: 8200466868; - AC; + ENG-PTO 6 PK 1840  
ALT MTR-CODE: G9U750; - AC; - ENG-PTO 7 PK 1105  
ALT MTR-CODE: G9U750; OE-NO.: 8200466868; - AC; + ENG-PTO 6 PK 1840  
CAM ZRK 1462  
CAM KT 1392

#### 2.5 D

2499 ccm 59 kW S8U 770 07.98 - AC-C MTR-CODE: S8U770 5 PK 1200  
AC-C MTR-CODE: S8U770;S8U772 5 PK 1200  
AC-C MTR-CODE: S8U772 5 PK 1200  
ALT FROM: 03.00; MTR-CODE: S8U770 6 PK 870  
ALT FROM: 03.00; MTR-CODE: S8U770;S8U772 6 PK 870  
ALT FROM: 03.00; MTR-CODE: S8U772 6 PK 870  
ALT UNTIL: 03.00; MTR-CODE: S8U770 6 PK 858  
ALT UNTIL: 03.00; MTR-CODE: S8U770;S8U772 6 PK 858  
ALT UNTIL: 03.00; MTR-CODE: S8U772 6 PK 858  
CAM ZRK 1312  
CAM KT 1229

#### 2.8 dTi

2799 ccm 84 kW S9W 702 07.98 - AC-C MTR-CODE: S9W700 5 PK 1200  
AC-C MTR-CODE: S9W700;S9W702 5 PK 1200  
ALT FROM: 03.00; MTR-CODE: S9W700; - AC 6 PK 850  
ALT FROM: 06.00; MTR-CODE: S9W700 6 PK 850  
ALT FROM: 06.00; MTR-CODE: S9W700;S9W702 6 PK 850  
ALT MTR-CODE: S9W700; + AC 5 PK 1200  
ALT UNTIL: 03.00; MTR-CODE: S9W700; - AC 6 PK 845  
ALT UNTIL: 03.00; MTR-CODE: S9W700;S9W702 6 PK 845  
ALT UNTIL: 06.00; MTR-CODE: S9W700 6 PK 845  
CAM ZRK 1332



## RENAULT

### MASTER II Bus (JD)

#### 2.8 dTi

2799 ccm	84 kW	S9W 702	07.98 -	CAM		KT 1340
----------	-------	---------	---------	-----	--	---------

#### 3.0 dCi 140 (JD0T)

2953 ccm	100 kW	ZD3 200;ZD3 202	10.03 -	ALT	MTR-CODE: ZD3200	7 PK 1920
				ALT	MTR-CODE: ZD3200;ZD3202	7 PK 1920

### MASTER II Kasten (FD)

#### 1.9 dTi

1870 ccm	59 kW	F9Q 770	09.00 -	ALT		6 PK 1130
				CAM		ZRK 1069
				CAM		KT 1493

#### 1.9 dCi 80

1870 ccm	60 kW	F9Q 772;F9Q 774	11.01 -	CAM		ZRK 1067
				CAM		KT 1434
				CAM	MTR-CODE: F9Q752	KT 1434 W1

#### 2.2 dCi 90

2188 ccm	66 kW	G9T 720;G9T 722;G9T 750	09.00 -	ALT	FROM: 11.04; MTR-CODE: G9T722;G9T750; - AC; - ENG-PTO	7 PK 1105
				ALT	FROM: 11.04; MTR-CODE: G9T750; - AC; - ENG-PTO	7 PK 1105
				ALT	MTR-CODE: G9T720; - AC; - ENG-PTO	6 PK 1145
				ALT	MTR-CODE: G9T720; OE-NO.: 7700109477; - AC; + ENG-PTO	6 PK 1795
				ALT	MTR-CODE: G9T720; OE-NO.: 7700109477; + AC	6 PK 1795
				ALT	MTR-CODE: G9T720; OE-NO.: 8200466868; - AC; + ENG-PTO	6 PK 1840
				ALT	MTR-CODE: G9T720; OE-NO.: 8200466868; + AC	6 PK 1840
				ALT	MTR-CODE: G9T720;G9T722; - AC; - ENG-PTO	6 PK 1145
				ALT	MTR-CODE: G9T720;G9T722; OE-NO.: 7700109477; - AC; + ENG-PTO	6 PK 1795
				ALT	MTR-CODE: G9T720;G9T722; OE-NO.: 7700109477; + AC	6 PK 1795
				ALT	MTR-CODE: G9T720;G9T722; OE-NO.: 8200466868; - AC; + ENG-PTO	6 PK 1840
				ALT	MTR-CODE: G9T720;G9T722; OE-NO.: 8200466868; + AC	6 PK 1840
				ALT	MTR-CODE: G9T722; - AC; - ENG-PTO	6 PK 1145
				ALT	MTR-CODE: G9T722; OE-NO.: 7700109477; - AC; + ENG-PTO	6 PK 1795
				ALT	MTR-CODE: G9T722; OE-NO.: 7700109477; + AC	6 PK 1795
				ALT	MTR-CODE: G9T722; OE-NO.: 8200466868; - AC; + ENG-PTO	6 PK 1840
				ALT	MTR-CODE: G9T722; OE-NO.: 8200466868; + AC	6 PK 1840
				ALT	MTR-CODE: G9T722;G9T750; + AC; - ENG-PTO	7 PK 1793
				ALT	MTR-CODE: G9T722;G9T750; OE-NO.: 7700109477; - AC; + ENG-PTO	6 PK 1795
				ALT	MTR-CODE: G9T722;G9T750; OE-NO.: 8200466868; - AC; + ENG-PTO	6 PK 1840
				ALT	MTR-CODE: G9T750; + AC; - ENG-PTO	7 PK 1793
				ALT	MTR-CODE: G9T750; OE-NO.: 7700109477; - AC; + ENG-PTO	6 PK 1795
				ALT	MTR-CODE: G9T750; OE-NO.: 8200466868; - AC; + ENG-PTO	6 PK 1840
				ALT	UNTIL: 11.04; MTR-CODE: G9T722;G9T750; - AC; - ENG-PTO	7 PK 1145
				ALT	UNTIL: 11.04; MTR-CODE: G9T750; - AC; - ENG-PTO	7 PK 1145
				CAM		ZRK 1462
				CAM		KT 1392

#### 2.5 dCi 100 (FD0U, FD0V)

2463 ccm	73 kW	G9U 754	10.03 -	CAM		ZRK 1462
				CAM		KT 1392

#### 2.5 dCi 120

2463 ccm	84 kW	G9U 720;G9U 754	10.01 -	CAM		ZRK 1462
				CAM		KT 1392

#### 2.5 dCi

2464 ccm	88 kW	G9U 650	08.06 -	ALT	MTR-CODE: G9U632; - AC; - ENG-PTO	7 PK 1110
----------	-------	---------	---------	-----	-----------------------------------	-----------





## RENAULT

### MASTER II Kasten (FD)

#### 2.5 dCi

2464 ccm	88 kW	G9U 650	08.06 -	ALT	MTR-CODE: G9U632; + AC	7 PK 1793
				ALT	MTR-CODE: G9U632; OE-NO.: 8200833558; - AC; + ENG-PTO	7 PK 1793
				ALT	MTR-CODE: G9U632;G9U650; - AC; - ENG-PTO	7 PK 1110
				ALT	MTR-CODE: G9U632;G9U650; + AC	7 PK 1793
				ALT	MTR-CODE: G9U632;G9U650; OE-NO.: 8200833558; - AC; + ENG-PTO	7 PK 1793
				ALT	MTR-CODE: G9U650; - AC; - ENG-PTO	7 PK 1110
				ALT	MTR-CODE: G9U650; + AC	7 PK 1793
				ALT	MTR-CODE: G9U650; OE-NO.: 8200833558; - AC; + ENG-PTO	7 PK 1793
				ALT	MTR-CODE: G9U720;G9U724; - AC; - ENG-PTO	6 PK 1145
				ALT	MTR-CODE: G9U720;G9U724; MOD: FD0M/FD0U/FD2M/FD3M; + AC	6 PK 1840
				ALT	MTR-CODE: G9U720;G9U724; OE-NO.: 8200466868; - AC; + ENG-PTO	6 PK 1840
				ALT	MTR-CODE: G9U750; + AC	7 PK 1793
				ALT	MTR-CODE: G9U750;G9U754; + AC	7 PK 1793
				CAM		ZRK 1462
				CAM		KT 1392

#### 2.5 dCi

2464 ccm	107 kW	G9U 632	08.06 -	ALT	MTR-CODE: G9U720;G9U724; - AC; - ENG-PTO	6 PK 1145
				CAM		ZRK 1462
				CAM		KT 1392

#### 2.5 D

2499 ccm	59 kW	S8U 770	07.98 -	AC-C	MTR-CODE: S8U770	5 PK 1200
				AC-C	MTR-CODE: S8U770;S8U772	5 PK 1200
				AC-C	MTR-CODE: S8U772	5 PK 1200
				ALT	FROM: 03.00; MTR-CODE: S8U770	6 PK 870
				ALT	FROM: 03.00; MTR-CODE: S8U770;S8U772	6 PK 870
				ALT	FROM: 03.00; MTR-CODE: S8U772	6 PK 870
				ALT	UNTIL: 03.00; MTR-CODE: S8U770	6 PK 858
				ALT	UNTIL: 03.00; MTR-CODE: S8U770;S8U772	6 PK 858
				ALT	UNTIL: 03.00; MTR-CODE: S8U772	6 PK 858
				CAM		ZRK 1312
				CAM		KT 1229

#### 2.8 dTi

2799 ccm	84 kW	S9W 702	07.98 -	AC-C	MTR-CODE: S9W700	5 PK 1200
				AC-C	MTR-CODE: S9W700;S9W702	5 PK 1200
				ALT	FROM: 06.00; MTR-CODE: S9W700	6 PK 850
				ALT	FROM: 06.00; MTR-CODE: S9W700;S9W702	6 PK 850
				ALT	UNTIL: 03.00; MTR-CODE: S9W700;S9W702	6 PK 845
				ALT	UNTIL: 06.00; MTR-CODE: S9W700	6 PK 845
				CAM		ZRK 1332
				CAM		KT 1340

#### 3.0 dCi 140 (HD0S, FD0S, HD1S)

2953 ccm	100 kW	ZD3 202	10.03 -	ALT	MTR-CODE: ZD3200;ZD3202	7 PK 1920
----------	--------	---------	---------	-----	-------------------------	-----------

### MASTER II Pritsche/Fahrgestell (ED/HD/UD)

#### 2.2 dCi 90

2188 ccm	66 kW	G9T 720;G9T 722;G9T 750	09.00 -	ALT	FROM: 11.04; MTR-CODE: G9T750; - AC; - ENG-PTO	7 PK 1105
				ALT	MTR-CODE: G9T720;G9T722; - AC; - ENG-PTO	6 PK 1145
				ALT	MTR-CODE: G9T720;G9T722; OE-NO.: 7700109477; - AC; + ENG-PTO	6 PK 1795
				ALT	MTR-CODE: G9T720;G9T722; OE-NO.: 7700109477; + AC	6 PK 1795
				ALT	MTR-CODE: G9T720;G9T722; OE-NO.: 8200466868; - AC; + ENG-PTO	6 PK 1840
				ALT	MTR-CODE: G9T720;G9T722; OE-NO.: 8200466868; + AC	6 PK 1840
				ALT	MTR-CODE: G9T750; + AC; - ENG-PTO	7 PK 1793
				ALT	MTR-CODE: G9T750; OE-NO.: 7700109477; - AC; + ENG-PTO	6 PK 1795
				ALT	MTR-CODE: G9T750; OE-NO.: 8200466868; - AC; + ENG-PTO	6 PK 1840
				ALT	UNTIL: 11.04; MTR-CODE: G9T750; - AC; - ENG-PTO	7 PK 1145
				CAM		ZRK 1462



## RENAULT

### MASTER II Pritsche/Fahrgestell (ED/HD/UD)

#### 2.2 dCi 90

2188 ccm	66 kW	G9T 720;G9T 722;G9T 750	09.00 -	CAM		KT 1392
----------	-------	-------------------------	---------	-----	--	---------

#### 2.5 dCi 100 (ED4V, ED8V)

2463 ccm	73 kW	G9U 754	10.03 -	ALT	- AC; + ENG-PTO	6 PK 1840
				ALT	MTR-CODE: G9U750; - AC; + ENG-PTO	6 PK 1795
				ALT	MTR-CODE: G9U750; + AC	7 PK 1793
				ALT	MTR-CODE: G9U754; - AC; - ENG-PTO	7 PK 1145
				ALT	MTR-CODE: G9U754; - AC; + ENG-PTO	6 PK 1795
				ALT	MTR-CODE: G9U754; + AC	7 PK 1793
				ALT	UNTIL: 11.04; MTR-CODE: G9U750; - AC; - ENG-PTO	7 PK 1145
				CAM		ZRK 1462
				CAM		KT 1392

#### 2.5 dCi

2464 ccm	74 kW	G9U 754	08.06 -	CAM		ZRK 1462
				CAM		KT 1392

#### 2.5 dCi 120

2463 ccm	84 kW	G9U 720;G9U 754	10.01 -	CAM		ZRK 1462
				CAM		KT 1392

#### 2.5 dCi

2464 ccm	88 kW	G9U 650	08.06 -	ALT	MTR-CODE: G9U632; - AC; - ENG-PTO	7 PK 1110
				ALT	MTR-CODE: G9U632; + AC	7 PK 1793
				ALT	MTR-CODE: G9U632; OE-NO.: 8200833558; - AC; + ENG-PTO	7 PK 1793
				ALT	MTR-CODE: G9U650; - AC; - ENG-PTO	7 PK 1110
				ALT	MTR-CODE: G9U650; + AC	7 PK 1793
				ALT	MTR-CODE: G9U650; OE-NO.: 8200833558; - AC; + ENG-PTO	7 PK 1793
				ALT	MTR-CODE: G9U720;G9U724; - AC; - ENG-PTO	6 PK 1145
				ALT	MTR-CODE: G9U750; + AC	7 PK 1793
				ALT	MTR-CODE: G9U754; + AC	7 PK 1793
				CAM		ZRK 1462
				CAM		KT 1392

#### 2.5 dCi

2464 ccm	107 kW	G9U 632	08.06 -	ALT	MTR-CODE: G9U720;G9U724; - AC; - ENG-PTO	6 PK 1145
				CAM		ZRK 1462
				CAM		KT 1392

#### 2.5 D

2499 ccm	59 kW	S8U 770	07.98 -	AC-C	MTR-CODE: S8U770	5 PK 1200
				AC-C	MTR-CODE: S8U772	5 PK 1200
				ALT	FROM: 03.00; MTR-CODE: S8U770	6 PK 870
				ALT	FROM: 03.00; MTR-CODE: S8U772	6 PK 870
				ALT	UNTIL: 03.00; MTR-CODE: S8U770	6 PK 858
				ALT	UNTIL: 03.00; MTR-CODE: S8U772	6 PK 858
				CAM		ZRK 1312
				CAM		KT 1229

#### 2.8 dTi

2799 ccm	84 kW	S9W 702	07.98 -	AC-C	MTR-CODE: S9W700	5 PK 1200
				AC-C	MTR-CODE: S9W700;S9W702	5 PK 1200
				ALT	FROM: 06.00; MTR-CODE: S9W700	6 PK 850
				ALT	FROM: 06.00; MTR-CODE: S9W700;S9W702	6 PK 850
				ALT	UNTIL: 03.00; MTR-CODE: S9W700;S9W702	6 PK 845
				ALT	UNTIL: 06.00; MTR-CODE: S9W700	6 PK 845
				CAM		ZRK 1332
				CAM		KT 1340

#### 3.0 dCi 120

2953 ccm	85 kW	ZD3 600	06.05 -	ALT	MTR-CODE: ZD3600;ZD3604	7 PK 1640
----------	-------	---------	---------	-----	-------------------------	-----------

#### 3.0 dCi 140 (ED0S, UD0S)

2953 ccm	100 kW	ZD3 202	10.03 -	ALT		7 PK 1920
----------	--------	---------	---------	-----	--	-----------

## RENAULT TRUCKS

### MASCOTT Kasten/Kombi

#### 90.35

2800 ccm	63 kW	8140.63.2585	01.99 - 12.01	CAM		KT 1229
----------	-------	--------------	---------------	-----	--	---------



## RENAULT TRUCKS

### MASCOTT Kasten/Kombi

#### 110.35

2800 ccm 78 kW 8140.43.B.3586;8140.43.B.3588; 01.99 - 06.04 CAM MTR-CODE: 8140.43.C.2586 **KT 1229**  
8140.43.C.2586

#### 110.50

2800 ccm 78 kW 8140.43.B.3586;8140.43.B.3588; 01.99 - 06.04 CAM MTR-CODE: 8140.43.C.2586 **KT 1229**  
8140.43.C.2586

#### 110.55

2800 ccm 78 kW 8140.43.B.3586;8140.43.B.3588; 01.99 - 06.04 CAM MTR-CODE: 8140.43.C.2586 **KT 1229**  
8140.43.C.2586

#### 130.35

2800 ccm 92 kW 8140.43.S.2585;8140.43.S.3585 01.99 - 06.04 CAM MTR-CODE: 8140.43.S.2585 **KT 1229**

#### 130.55

2800 ccm 92 kW 8140.43.S.2585;8140.43.S.3585 01.99 - 06.04 CAM MTR-CODE: 8140.43.S.2585 **KT 1229**

#### 140.35

2800 ccm 103 kW 8140-43 k 01.01 - 06.04 CAM **KT 1229**

#### 140.55

2800 ccm 103 kW 8140-43 k 01.01 - 06.04 CAM **KT 1229**

### MASCOTT Pritsche/Fahrgestell

#### 90

2800 ccm 63 kW 8140.63.2585 01.99 - 12.01 AC-C MOD: Mascott90 **4 PK 1015**  
ALT MOD: Mascott90 **6 PK 1055**  
CAM **KT 1229**

#### 110

2800 ccm 78 kW 8140.43.B.3586;8140.43.B.3588; 01.99 - 06.04 AC-C MTR-CODE: 8140.43.C.2586; MOD: Mascott110 **4 PK 1015**  
8140.43.C.2586  
ALT MTR-CODE: 8140.43.C.2586; MOD: Mascott110 **6 PK 1055**  
CAM MTR-CODE: 8140.43.C.2586 **KT 1229**

#### 110

2800 ccm 78 kW 8140.43.B.3586;8140.43.B.3588; 01.99 - 06.04 AC-C MTR-CODE: 8140.43.C.2586; MOD: Mascott110 **4 PK 1015**  
8140.43.C.2586  
ALT MTR-CODE: 8140.43.C.2586; MOD: Mascott110 **6 PK 1055**  
CAM MTR-CODE: 8140.43.C.2586 **KT 1229**

#### 110

2800 ccm 78 kW 8140.43.B.3586;8140.43.B.3588; 01.99 - 06.04 AC-C MTR-CODE: 8140.43.C.2586; MOD: Mascott110 **4 PK 1015**  
8140.43.C.2586  
ALT MTR-CODE: 8140.43.C.2586; MOD: Mascott110 **6 PK 1055**  
CAM MTR-CODE: 8140.43.C.2586 **KT 1229**

#### 110

2800 ccm 78 kW 8140.43.B.3586;8140.43.B.3588; 01.99 - 06.04 AC-C MTR-CODE: 8140.43.C.2586; MOD: Mascott110 **4 PK 1015**  
8140.43.C.2586  
ALT MTR-CODE: 8140.43.C.2586; MOD: Mascott110 **6 PK 1055**  
CAM MTR-CODE: 8140.43.C.2586 **KT 1229**

#### 130

2800 ccm 92 kW 8140.43.S.2585;8140.43.S.3585 01.99 - 06.04 AC-C MTR-CODE: 8140.43.S.2585; MOD: Mascott130 **4 PK 1015**  
ALT MTR-CODE: 8140.43.S.2585; MOD: Mascott130 **6 PK 1055**  
CAM MTR-CODE: 8140.43.S.2585 **KT 1229**

#### 130

2800 ccm 92 kW 8140.43.S.2585;8140.43.S.3585 01.99 - 06.04 AC-C MTR-CODE: 8140.43.S.2585; MOD: Mascott130 **4 PK 1015**  
ALT MTR-CODE: 8140.43.S.2585; MOD: Mascott130 **6 PK 1055**  
CAM MTR-CODE: 8140.43.S.2585 **KT 1229**

#### 130

2800 ccm 92 kW 8140.43.S.2585;8140.43.S.3585 01.99 - 06.04 AC-C MTR-CODE: 8140.43.S.2585; MOD: Mascott130 **4 PK 1015**  
ALT MTR-CODE: 8140.43.S.2585; MOD: Mascott130 **6 PK 1055**  
CAM MTR-CODE: 8140.43.S.2585 **KT 1229**

#### 140

2800 ccm 103 kW 8140-43 k 01.01 - 06.04 CAM **KT 1229**

#### 140

2800 ccm 103 kW 8140-43 k 01.01 - 06.04 CAM **KT 1229**

#### 140

2800 ccm 103 kW 8140-43 k 01.01 - 06.04 CAM **KT 1229**

### MASCOTT Kipper

#### 90

2800 ccm 78 kW 8140.43.B.3586;8140.43.B.3588; 01.00 - 06.04 CAM MTR-CODE: 8140.43.C.2586 **KT 1229**  
8140.43.C.2586



## RENAULT TRUCKS

### MASCOTT Kipper

<b>110</b>							
2800 ccm	78 kW	8140.43.B.3586;8140.43.B.3588; 8140.43.C.2586	01.00 - 06.04	CAM		MTR-CODE: 8140.43.C.2586	KT 1229

## SSANGYONG

### ISTANA Bus

<b>2.9 TD</b>							
2874 ccm	70 kW	OM 602.940	10.92 - 05.95	ALT	+ AC; + PS		6 PK 2080
				ALT	FROM MTR-NO: 253307; + AC; - PS		6 PK 2020
				ALT	FROM MTR-NO: 253308; - AC; - PS		6 PK 995
				ALT	FROM MTR-NO: 253308; + PS; - AC		6 PK 1980
				ALT	UNTIL MTR-NO: 253306; + AC; - PS		6 PK 2030
				ALT	UNTIL MTR-NO: 253307; - AC; - PS		6 PK 1015
				ALT	UNTIL MTR-NO: 253307; + PS; - AC		6 PK 2000

### ISTANA Kasten

<b>2.9 D</b>							
2874 ccm	70 kW	OM 602.940	10.92 - 05.95	ALT	+ AC; + PS		6 PK 2080
				ALT	FROM MTR-NO: 253307; + AC; - PS		6 PK 2020
				ALT	FROM MTR-NO: 253308; - AC; - PS		6 PK 995
				ALT	FROM MTR-NO: 253308; + PS; - AC		6 PK 1980
				ALT	UNTIL MTR-NO: 253306; + AC; - PS		6 PK 2030
				ALT	UNTIL MTR-NO: 253307; - AC; - PS		6 PK 1015
				ALT	UNTIL MTR-NO: 253307; + PS; - AC		6 PK 2000

### ISTANA Bus

<b>2.9 D</b>							
2874 ccm	90 kW	OM 602.980	06.95 -	ALT	- AC		6 PK 2080
				ALT	+ AC		6 PK 2140

### ISTANA Kasten

<b>2.9 D</b>							
2874 ccm	90 kW	OM 602.980	06.95 -	ALT	- AC		6 PK 2080
				ALT	+ AC		6 PK 2140

## SUBARU

### LIBERO Bus (E10, E12)

<b>1.0 4WD (E10, KJ6)</b>							
998 ccm	37 kW	EF10	01.83 - 12.87	ALT			AVX 10 x 913
				CAM			ZRK 1034
<b>1.2 4WD (E12, KJ8)</b>							
1190 ccm	38 kW	EF12	08.86 - 02.00	ALT	UNTIL: 12.93		AVX 10 x 700
<b>1.2 i 4WD (E12, FA)</b>							
1189 ccm	40 kW	EF12	08.91 - 02.00	ALT			AVX 10 x 715
				ALT	FROM: 01.94		AVX 10 x 710
				ALT	FROM: 10.93; - AC		4 PK 705
				ALT	FROM: 10.93; + AC		4 PK 970

## SUZUKI

### SUPER CARRY Bus (ED)

<b>1.0</b>							
970 ccm	30 kW	F10A	09.94 - 03.99	AC-C			AVX 10 x 750
				ALT			AVX 10 x 750
				CAM			ZRK 1034
				CAM			KT 1259
<b>1.0</b>							
970 ccm	31 kW	F10A	10.92 - 03.99	AC-C			AVX 10 x 750
				ALT			AVX 10 x 750
				CAM			ZRK 1034
				CAM			KT 1259
<b>1.0 (SK)</b>							
970 ccm	33 kW	F10A	10.85 - 03.99	AC-C			AVX 10 x 750
				ALT			AVX 10 x 750
				CAM			ZRK 1034
				CAM			KT 1259

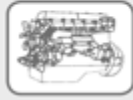

## TOYOTA

### DYNA 100 Pritsche/Fahrgestell (YH\_)

<b>1.8</b>						
1812 ccm	58 kW	2Y	08.85 - 04.95	ALT	MOD: 100	5 PK 820

### DYNA Pritsche/Fahrgestell (KD\_, \_U7\_, \_C6\_, \_U6\_, LY\_, TRY2\_)

<b>2.5 D4d</b>						
2494 ccm	65 kW	2KD-FTV	08.01 -	ALT	MOD: 150; - AC	7 PK 1093
				ALT	MOD: 150; + AC	7 PK 1473
<b>2.5 D4d</b>						
2494 ccm	75 kW	2KD-FTV	08.01 -	ALT	MOD: 150; - AC	7 PK 1093
				ALT	MOD: 150; + AC	7 PK 1473
<b>3.0 D4d</b>						
2982 ccm	80 kW	1KD-FTV	09.06 -	ALT	MTR-CODE: 1KDFTV; MOD: 150; - AC	7 PK 1093
				ALT	MTR-CODE: 1KDFTV; MOD: 150; + AC	7 PK 1473

### HIACE III Wagon (LH1\_, RZH1\_)

<b>2.0 (RZH102)</b>						
1998 ccm	74 kW	1RZ	08.89 - 08.95	ALT		5 PK 865
<b>2.4 (RZH103)</b>						
2438 ccm	88 kW	2RZ-E	08.89 - 08.95	ALT		5 PK 865
<b>2.4 D (LH102)</b>						
2446 ccm	55 kW	2L	08.89 - 08.95	AC-C	FROM: 10.93	AVX 13 x 1260
				ALT	UNTIL: 08.89; REQ: 2	AVX 10 x 975
				PS	FROM: 08.89	AVX 13 x 850
				ALT	FROM: 08.89; MTR-CODE: LH108	2/AVX 13 x 1050
				PS	FROM: 01.92; AWD	4 PK 835
				CAM		ZRK 1134
				CAM		KT 1107
<b>2.4 D 4WD</b>						
2446 ccm	55 kW	2L	08.89 - 08.95	PS	FROM: 01.92; AWD	4 PK 835
				CAM		ZRK 1134
				CAM		KT 1107
<b>2.4 D</b>						
2446 ccm	57 kW	2L	10.93 - 08.95	AC-C		AVX 13 x 1260
				ALT		2/AVX 13 x 1050
				PS	AWD	4 PK 835
				CAM		ZRK 1134
				CAM		KT 1107

### HIACE III Kasten (H50)

<b>2.0</b>						
1998 ccm	74 kW	1RZ	02.90 - 08.95	ALT		5 PK 865
<b>2.4</b>						
2438 ccm	88 kW	2RZ-E	08.89 - 08.95	ALT		5 PK 865
<b>2.4 4WD</b>						
2438 ccm	88 kW	2RZ-E	08.89 - 08.95	ALT		5 PK 865
<b>2.4 D</b>						
2446 ccm	55 kW	2L	02.90 - 08.95	PS		AVX 13 x 850
				ALT		2/AVX 13 x 1050
				PS	AWD	4 PK 835
				CAM		ZRK 1134
				CAM		KT 1107
<b>2.4 D 4WD</b>						
2446 ccm	55 kW	2L	08.89 - 08.95	PS	AWD	4 PK 835
				CAM		ZRK 1134
				CAM		KT 1107
<b>2.4 D</b>						
2446 ccm	57 kW	2L	09.89 - 08.95	PS	AWD	4 PK 835

### HIACE IV Wagon (H100)

<b>2.5 D-4D 4WD</b>						
2494 ccm	75 kW	2KD-FTV	08.01 - 08.06	ALT	- AC	7 PK 1093
				ALT	+ AC	7 PK 1473

### HIACE IV Bus

<b>2.4 (RCH12_, RCH22_)</b>						
2438 ccm	85 kW	2RZ-E	08.95 -	AC-C		4 PK 860
				ALT		5 PK 865



## TOYOTA

### HIACE IV Bus

#### 2.4 4WD (RCH18\_)

2438 ccm	85 kW	2RZ-E	08.95 -	AC-C		4 PK 860
				ALT		5 PK 865

#### 2.7 (RCH13\_, RCH23\_)

2694 ccm	105 kW	3RZ-FE	04.98 -	AC-C		4 PK 940
				ALT		5 PK 865
				PS		4 PK 1100

#### 2.7 4WD (RCH19\_)

2694 ccm	105 kW	3RZ-FE	04.98 -	AC-C		4 PK 940
				ALT		5 PK 865
				PS		4 PK 1100

#### 2.7

2694 ccm	106 kW	3RZ-FE	11.01 -	AC-C		4 PK 940
				ALT		5 PK 865
				PS		4 PK 1100

#### 2.4 D

2446 ccm	55 kW	2L	07.99 -	PS		4 PK 775
				CAM		ZRK 1134
				CAM		KT 1107

#### 2.4 D

2446 ccm	58 kW	2L	08.95 -	PS		4 PK 775
				CAM		ZRK 1134
				CAM		KT 1107

#### 2.4 TD (LXH12\_, LXH22\_)

2446 ccm	66 kW	2L-T	08.95 -	PS		4 PK 775
				CAM		ZRK 1134
				CAM		KT 1107

#### 2.4 TD 4WD (H18/28)

2446 ccm	66 kW	2L-T	08.95 -	PS	FROM: 10.96	4 PK 775
				CAM		ZRK 1134
				CAM		KT 1107

#### 2.5 D-4D

2494 ccm	65 kW	2KD-FTV	11.01 -	ALT	- AC	7 PK 1093
				ALT	+ AC	7 PK 1473
				CAM		ZRK 1580
				CAM		KT 1508

#### 2.5 D-4D

2494 ccm	75 kW	2KD-FTV	11.01 -	ALT	- AC	7 PK 1093
				ALT	+ AC	7 PK 1473
				CAM		ZRK 1580
				CAM		KT 1508

### HIACE IV Kasten (RCH2\_, RCH1\_, KLH2\_, KLH1\_)

#### 2.4 (RCH12\_, RCH22\_)

2438 ccm	85 kW	2RZ-E	08.95 -	AC-C		4 PK 860
				ALT		5 PK 865

#### 2.4 4WD (RCH18\_, RCH28\_)

2438 ccm	85 kW	2RZ-E	08.95 -	AC-C		4 PK 860
				ALT		5 PK 865

#### 2.7 (RCH13\_, RCH23\_)

2694 ccm	105 kW	3RZ-FE	04.98 -	AC-C		4 PK 940
				ALT		5 PK 865
				PS		4 PK 1100

#### 2.7 4WD (RCH19\_, RCH29\_)

2694 ccm	106 kW	3RZ-FE	04.98 -	AC-C		4 PK 940
				ALT		5 PK 865
				PS		4 PK 1100

#### 2.4 D

2446 ccm	55 kW	2L	09.95 -	PS		4 PK 775
----------	-------	----	---------	----	--	----------

#### 2.4 D (LXH12\_, LXH22\_)

2446 ccm	58 kW	2L	08.95 -	AC-C		AVX 13 x 1225
				ALT	REQ: 2	AVX 13 x 1050
				PS		4 PK 775
				CAM		ZRK 1134
				CAM		KT 1107

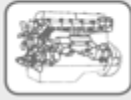

## TOYOTA

### HIACE IV Kasten (RCH2\_, RCH1\_, KLH2\_, KLH1\_)

#### 2.4 TD (LXH12\_, LXH22\_)

2446 ccm	66 kW	2L-T	08.95 -	PS		4 PK 775
				CAM		ZRK 1134
				CAM		KT 1107

#### 2.4 TD 4WD (LXH18\_, LXH28\_)

2446 ccm	66 kW	2L-T	08.95 -	PS	FROM: 10.96	4 PK 775
				CAM		ZRK 1134
				CAM		KT 1107

#### 2.5 D-4D

2494 ccm	65 kW	2KD-FTV	11.01 -	ALT	- AC	7 PK 1093
				ALT	+ AC	7 PK 1473
				CAM		ZRK 1580
				CAM		KT 1508

#### 2.5 D-4D

2494 ccm	75 kW	2KD-FTV	11.01 -	ALT	- AC	7 PK 1093
				ALT	+ AC	7 PK 1473
				CAM		ZRK 1580
				CAM		KT 1508

#### 2.5 D-4D 4WD

2494 ccm	75 kW	2KD-FTV	11.01 -	ALT	- AC	7 PK 1093
				ALT	+ AC	7 PK 1473
				CAM		ZRK 1580
				CAM		KT 1508

### HIACE V Wagon (TRH2\_, KDH2\_)

#### 2.7 VVTi

2694 ccm	111 kW	2TR-FE	01.05 -	ALT	- AC	7 PK 1870
				ALT	+ AC	7 PK 2283

### HIACE V Kasten (TRH2\_, KDH2\_)

#### 2.7 VVTi (TRH201, TRH221)

2694 ccm	111 kW	2TR-FE	01.05 -	ALT	- AC	7 PK 1870
				ALT	+ AC	7 PK 2283

### HIACE V Bus (RCH2\_, RCH1\_, LXH2\_, LXH1\_, KLH2\_, KLH1\_)

#### 2.5 D-4D

2494 ccm	70 kW	2KD-FTV	08.06 -	ALT	+ AC	7 PK 1933
				CAM		ZRK 1580
				CAM		KT 1508

#### 2.5 D-4D

2494 ccm	86 kW	2KD-FTV	08.06 -	ALT	+ AC	7 PK 1933
				CAM		ZRK 1580
				CAM		KT 1508

### HIACE V Kasten (RCH2\_, RCH1\_, LXH2\_, LXH1\_, KLH2\_, KLH1\_)

#### 2.5 D-4D

2494 ccm	70 kW	2KD-FTV	09.06 -	ALT	+ AC	7 PK 1933
----------	-------	---------	---------	-----	------	-----------

#### 2.5 D-4D

2494 ccm	86 kW	2KD-FTV	09.06 -	ALT	+ AC	7 PK 1933
----------	-------	---------	---------	-----	------	-----------

#### 2.5 D-4D 4WD

2494 ccm	86 kW	2KD-FTV	09.06 -	ALT	+ AC	7 PK 1933
----------	-------	---------	---------	-----	------	-----------

### LITEACE Bus (\_R2\_LG)

#### 2.2 (YR22LG)

2237 ccm	72 kW	4Y-EC	01.92 - 01.95	ALT		5 PK 820
----------	-------	-------	---------------	-----	--	----------

#### 2.0 D (CR21LG)

1974 ccm	53 kW	2C	01.92 - 05.94	PS	FROM: 03.93	3 PK 835
				PS	UNTIL: 03.93	3 PK 800
				CAM		ZRK 1148
				CAM		KT 1344

### LITEACE Kasten (\_R2\_V)

#### 2.2 (YR29LV)

2237 ccm	72 kW	4Y-EC	01.92 - 01.95	ALT		5 PK 820
----------	-------	-------	---------------	-----	--	----------

#### 2.0 D (CR27\_V)

1974 ccm	51 kW	2C	01.92 - 05.94	PS	FROM: 03.93	3 PK 835
				PS	UNTIL: 03.93	3 PK 800
				CAM		KT 1344



## VAUXHALL

### MOVANO Mk I (A) Combi (JD)

<b>1.9 DTI</b>							
1870 ccm	59 kW	F9Q 770	09.00 - 10.01	CAM CAM			ZRK 1069 KT 1247
<b>1.9 DTI</b>							
1870 ccm	60 kW	F9Q 774	10.01 - 05.10	ALT ALT CAM CAM CAM	FROM: 10.03; - AC FROM: 10.03; + AC		5 PK 1125 6 PK 1795 ZRK 1067 KT 1434 KT 1434 W1
<b>2.2 DTI</b>							
2188 ccm	66 kW	G9T 720;G9T 750	09.00 - 05.10	ALT  ALT ALT ALT ALT  CAM CAM	FROM: 11.04; MTR-CODE: G9T750; - AC; - ENG-PTO MTR-CODE: G9T722; - AC MTR-CODE: G9T722; + AC MTR-CODE: G9T750; + AC; + ENG-PTO UNTIL: 11.04; MTR-CODE: G9T750; - AC; - ENG-PTO		7 PK 1105  6 PK 1145 6 PK 1795 7 PK 1793 7 PK 1145  ZRK 1462 KT 1392
<b>2.5 D</b>							
2499 ccm	59 kW	S8U 770	10.98 - 09.00	AC-C ALT ALT CAM CAM	FROM MTR-NO: 3053819 UNTIL MTR-NO: 3053818		5 PK 1200 6 PK 870 6 PK 858 ZRK 1312 KT 1229
<b>2.5 CDTI</b>							
2463 ccm	74 kW	G9U 650;G9U 754	10.01 - 08.09	ALT ALT  CAM CAM	FROM: 09.06; - AC; - ENG-PTO FROM: 09.06; OE-NO.: 93195485;4418675; + AC; + ENG-PTO		7 PK 1110 7 PK 1793  ZRK 1462 KT 1392
<b>2.5 DTI</b>							
2463 ccm	84 kW	G9U 720;G9U 750;G9U 754	10.01 - 08.09	ALT ALT ALT ALT ALT  CAM CAM	FROM: 09.02; MTR-CODE: G9U724; - AC FROM: 09.02; MTR-CODE: G9U724; + AC FROM: 09.02; MTR-CODE: G9U750; + AC FROM: 09.02; MTR-CODE: G9U750; OE-NO.: 9121108;4405275; - AC; - ENG-PTO FROM: 09.02; MTR-CODE: G9U750; OE-NO.: 93186955;4416361; - AC; - ENG-PTO FROM: 09.02; MTR-CODE: G9U750; OE-NO.: 93195484;4418674; - AC; - ENG-PTO		6 PK 1145 6 PK 1795 7 PK 1793 7 PK 1145 7 PK 1105 7 PK 1105  ZRK 1462 KT 1392
<b>2.5 CDTI</b>							
2464 ccm	88 kW	G9U 632;G9U 650	02.03 - 08.09	ALT ALT CAM CAM	- AC; - ENG-PTO OE-NO.: 93195485;4418675; + AC; + ENG-PTO		7 PK 1110 7 PK 1793 ZRK 1462 KT 1392
<b>2.5 CDTI</b>							
2464 ccm	107 kW	G9U 632	08.06 - 05.10	ALT ALT CAM CAM	- AC; - ENG-PTO OE-NO.: 93195485;4418675; + AC; + ENG-PTO		7 PK 1110 7 PK 1793 ZRK 1462 KT 1392
<b>2.8 DTI</b>							
2799 ccm	84 kW	S9W 702	10.98 - 10.01	AC-C ALT ALT CAM CAM	FROM MTR-NO: 3053819 UNTIL MTR-NO: 3053818		5 PK 1200 6 PK 850 6 PK 845 ZRK 1332 KT 1340
<b>3.0 DTi</b>							
2953 ccm	100 kW	ZD3 200	10.03 - 05.10	ALT			7 PK 1920
<b>MOVANO Mk I (A) Van (FD)</b>							
<b>1.9 DTI</b>							
1870 ccm	59 kW	F9Q 770	09.00 - 10.01	CAM CAM			ZRK 1069 KT 1247
<b>1.9 DTI</b>							
1870 ccm	60 kW	F9Q 774	10.01 - 05.10	ALT	FROM: 10.03; - AC		5 PK 1125



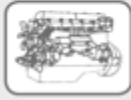

## VAUXHALL

### MOVANO Mk I (A) Van (FD)

#### 1.9 DTI

1870 ccm	60 kW	F9Q 774	10.01 - 05.10	ALT	FROM: 10.03; + AC	6 PK 1795
				CAM		ZRK 1067
				CAM		KT 1434
				CAM		KT 1434 W1

#### 2.2 DTI

2188 ccm	66 kW	G9T 720;G9T 722;G9T 750	09.00 - 05.10	ALT	FROM: 11.04; MTR-CODE: G9T750; - AC; - ENG-PTO	7 PK 1105
				ALT	MTR-CODE: G9T722; - AC	6 PK 1145
				ALT	MTR-CODE: G9T722; + AC	6 PK 1795
				ALT	MTR-CODE: G9T750; + AC; + ENG-PTO	7 PK 1793
				ALT	UNTIL: 11.04; MTR-CODE: G9T750; - AC; - ENG-PTO	7 PK 1145
				CAM		ZRK 1462
				CAM		KT 1392

#### 2.5 D

2499 ccm	59 kW	S8U 770	10.98 - 09.00	AC-C		5 PK 1200
				ALT	FROM MTR-NO: 3053819	6 PK 870
				ALT	UNTIL MTR-NO: 3053818	6 PK 858
				CAM		ZRK 1312
				CAM		KT 1229

#### 2.5 CDTI

2463 ccm	74 kW	G9U 650;G9U 754	04.04 - 05.10	ALT	FROM: 09.06; - AC; - ENG-PTO	7 PK 1110
				ALT	FROM: 09.06; OE-NO.: 93195485;4418675; + AC; + ENG-PTO	7 PK 1793
				CAM		ZRK 1462
				CAM		KT 1392

#### 2.5 DTI

2463 ccm	84 kW	G9U 720;G9U 724;G9U 750;G9U 754	10.01 - 05.10	ALT	MTR-CODE: G9U720; - AC	6 PK 1145
				ALT	MTR-CODE: G9U720; + AC	6 PK 1795
				ALT	MTR-CODE: G9U750; + AC	7 PK 1793
				ALT	MTR-CODE: G9U750; OE-NO.: 9121108;4405275; - AC; - ENG-PTO	7 PK 1145
				ALT	MTR-CODE: G9U750; OE-NO.: 93186955;4416361; - AC; - ENG-PTO	7 PK 1105
				ALT	MTR-CODE: G9U750; OE-NO.: 93195484;4418674; - AC; - ENG-PTO	7 PK 1105
				CAM		ZRK 1462
				CAM		KT 1392

#### 2.5 CDTI

2464 ccm	88 kW	G9U 632;G9U 650	08.06 - 05.10	ALT	- AC; - ENG-PTO	7 PK 1110
				ALT	OE-NO.: 93195485;4418675; + AC; + ENG-PTO	7 PK 1793
				CAM		ZRK 1462
				CAM		KT 1392

#### 2.5 CDTI

2464 ccm	107 kW	G9U 632	08.06 - 05.10	ALT	- AC; - ENG-PTO	7 PK 1110
				ALT	OE-NO.: 93195485;4418675; + AC; + ENG-PTO	7 PK 1793
				CAM		ZRK 1462
				CAM		KT 1392

#### 2.8 TDI

2799 ccm	84 kW	S9W 702	10.98 - 10.01	AC-C		5 PK 1200
				ALT	FROM MTR-NO: 3053819	6 PK 850
				ALT	UNTIL MTR-NO: 3053818	6 PK 845
				CAM		ZRK 1332
				CAM		KT 1340

#### 3.0 DTI

2953 ccm	100 kW	ZD3 202	10.03 - 05.10	ALT		7 PK 1920
----------	--------	---------	---------------	-----	--	-----------

### MOVANO Mk I (A) Chassis/Cab (ED, UD, HD)

#### 2.2 DTI

2188 ccm	66 kW	G9T 720;G9T 722;G9T 750	09.00 - 05.10	ALT	MTR-CODE: G9T720;G9T722; - AC	6 PK 1145
				ALT	MTR-CODE: G9T720;G9T722; + AC	6 PK 1795
				ALT	MTR-CODE: G9T722; - AC; - ENG-PTO	7 PK 1145
				ALT	MTR-CODE: G9T722; + AC; + ENG-PTO	7 PK 1793
				CAM		ZRK 1462
				CAM		KT 1392

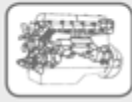

## VAUXHALL

### MOVANO Mk I (A) Chassis/Cab (ED, UD, HD)

<b>2.5 D</b>						
2499 ccm	59 kW	S8U 770	10.98 - 09.00	AC-C		5 PK 1200
				ALT	FROM MTR-NO: 3053819	6 PK 870
				ALT	UNTIL MTR-NO: 3053818	6 PK 858
				CAM		ZRK 1312
				CAM		KT 1229
<b>2.5 CDTI</b>						
2463 ccm	74 kW	G9U 650;G9U 754	04.04 - 05.10	ALT	FROM: 09.06; MTR-CODE: G9U650; - AC; - ENG-PTO	7 PK 1110
				ALT	FROM: 09.06; MTR-CODE: G9U650; OE-NO.: 93195485;4418675; + AC; + ENG-PTO	7 PK 1793
				CAM		ZRK 1462
				CAM		KT 1392
<b>2.5 DTI</b>						
2463 ccm	84 kW	G9U 720;G9U 724;G9U 754	10.01 - 05.10	ALT	MTR-CODE: G9U720; - AC	6 PK 1145
				ALT	MTR-CODE: G9U720; + AC	6 PK 1795
				CAM		ZRK 1462
				CAM		KT 1392
<b>2.5 CDTI</b>						
2463 ccm	88 kW	G9U 632;G9U 650	08.06 - 05.10	ALT	MTR-CODE: G9U650; - AC; - ENG-PTO	7 PK 1110
				ALT	MTR-CODE: G9U650; OE-NO.: 93195485;4418675; + AC; + ENG-PTO	7 PK 1793
				CAM		ZRK 1462
				CAM		KT 1392
<b>2.5 CDTI</b>						
2463 ccm	107 kW	G9U 632	08.06 - 05.10	ALT	MTR-CODE: G9U650; - AC; - ENG-PTO	7 PK 1110
				ALT	MTR-CODE: G9U650; OE-NO.: 93195485;4418675; + AC; + ENG-PTO	7 PK 1793
				CAM		ZRK 1462
				CAM		KT 1392
<b>2.8 DTI</b>						
2799 ccm	84 kW	S9W 702	10.98 - 10.01	AC-C		5 PK 1200
				ALT	FROM MTR-NO: 3053819	6 PK 850
				ALT	UNTIL MTR-NO: 3053818	6 PK 845
				CAM		ZRK 1332
				CAM		KT 1340
<b>3.0 DTi</b>						
2953 ccm	100 kW	ZD3 202	10.03 - 05.10	ALT		7 PK 1920
<b>VIVARO Combi (J7)</b>						
<b>2.0 16V</b>						
1998 ccm	88 kW	F4R 720	08.01 -	ALT	- AC	5 PK 1125
				ALT	+ AC	6 PK 1795
				CAM	MTR-CODE: F4R720;F4R820	ZRK 1475
<b>1.9 DI</b>						
1870 ccm	59 kW	F9Q 762	08.01 -	ALT	- AC	5 PK 1125
				ALT	+ AC	6 PK 1795
				CAM		ZRK 1067
				CAM		KT 1434
				CAM		KT 1434 W1
<b>1.9 DTI</b>						
1870 ccm	74 kW	F9Q 760	08.01 -	ALT	- AC	5 PK 1125
				ALT	+ AC	6 PK 1795
				CAM		ZRK 1067
				CAM		KT 1434
				CAM		KT 1434 W1
<b>2.0 CDTI</b>						
1995 ccm	66 kW	M9R 630;M9R 780;M9R 782;M9R 786	01.06 -	ALT	FROM: 08.06; OE-NO.: 93161809;4431667; - AC; + ENG-PTO	7 PK 1970
				ALT	FROM: 08.06; OE-NO.: 93161809;4431667; + AC; + ENG-PTO	7 PK 1970
				ALT	FROM: 08.06; OE-NO.: 93198427;4434866; - AC; + ENG-PTO	7 PK 2000
<b>2.0 CDTI</b>						
1995 ccm	84 kW	M9R 630;M9R 780;M9R 784;M9R 786;M9R 788	08.06 -	ALT	+ AC; + ENG-PTO	7 PK 1970
				ALT	OE-NO.: 93161809;4431667; - AC; + ENG-PTO	7 PK 1970
				ALT	OE-NO.: 93198427;4434866; - AC; + ENG-PTO	7 PK 2000



## VAUXHALL

### VIVARO Combi (J7)

#### 2.5 DTI

2463 ccm	99 kW	G9U 630;G9U 730	04.04 -	ALT	- AC; - ENG-PTO	6 PK 1145
				ALT	OE-NO.: 93161358;4430217; + AC; + ENG-PTO	6 PK 1840
				ALT	OE-NO.: 93196393;4418809; + AC; + ENG-PTO	6 PK 1795
				CAM		ZRK 1462
				CAM		KT 1392

### VIVARO Kasten (F7)

#### 2.0 16V

1998 ccm	88 kW	F4R 720	08.01 -	ALT	FROM: 03.02; - AC	5 PK 1125
				ALT	FROM: 03.02; + AC	6 PK 1795
				CAM	MTR-CODE: F4R720;F4R820	ZRK 1475

#### 1.9 DI

1870 ccm	59 kW	F9Q 762	08.01 -	ALT	- AC	5 PK 1125
				ALT	+ AC	6 PK 1795
				CAM		ZRK 1067
				CAM		KT 1434
				CAM		KT 1434 W1

#### 1.9 DTI

1870 ccm	74 kW	F9Q 760	08.01 -	ALT	- AC	5 PK 1125
				ALT	+ AC	6 PK 1795
				CAM		ZRK 1067
				CAM		KT 1434
				CAM		KT 1434 W1

#### 2.0 CDTI

1995 ccm	66 kW	M9R 630;M9R 780;M9R 782;M9R 786	01.06 -	ALT	FROM: 08.06; OE-NO.: 93161809;4431667; - AC; + ENG-PTO	7 PK 1970
				ALT	FROM: 08.06; OE-NO.: 93161809;4431667; + AC; + ENG-PTO	7 PK 1970
				ALT	FROM: 08.06; OE-NO.: 93198427;4434866; - AC; + ENG-PTO	7 PK 2000

#### 2.0 CDTI

1995 ccm	84 kW	M9R 630;M9R 780;M9R 788	08.06 -	ALT	+ AC; + ENG-PTO	7 PK 1970
				ALT	OE-NO.: 93161809;4431667; - AC; + ENG-PTO	7 PK 1970
				ALT	OE-NO.: 93198427;4434866; - AC; + ENG-PTO	7 PK 2000

#### 2.5 DTI

2463 ccm	99 kW	G9U 630;G9U 730	04.04 -	ALT	- AC; - ENG-PTO	6 PK 1145
				ALT	OE-NO.: 93161358;4430217; + AC; + ENG-PTO	6 PK 1840
				ALT	OE-NO.: 93196393;4418809; + AC; + ENG-PTO	6 PK 1795
				CAM		ZRK 1462
				CAM		KT 1392

#### 2.5 CDTI

2464 ccm	107 kW	G9U 630	08.06 -	ALT	OE-NO.: 93195485;4418675; + AC; + ENG-PTO	7 PK 1793
				CAM		ZRK 1462
				CAM		KT 1392

### VIVARO Pritsche/Fahrgestell (E7)

#### 2.0 CDTI

1995 ccm	66 kW	M9R 630;M9R 782	01.06 -	ALT	FROM: 08.06; OE-NO.: 93161809;4431667; - AC; + ENG-PTO	7 PK 1970
				ALT	FROM: 08.06; OE-NO.: 93161809;4431667; + AC; + ENG-PTO	7 PK 1970
				ALT	FROM: 08.06; OE-NO.: 93198427;4434866; - AC; + ENG-PTO	7 PK 2000

#### 2.0 CDTI

1995 ccm	84 kW	M9R 630;M9R 780;M9R 788	08.06 -	ALT	+ AC; + ENG-PTO	7 PK 1970
				ALT	OE-NO.: 93161809;4431667; - AC; + ENG-PTO	7 PK 1970
				ALT	OE-NO.: 93198427;4434866; - AC; + ENG-PTO	7 PK 2000

#### 2.5 CDTI

2463 ccm	99 kW	G9U 630;G9U 730	04.03 -	ALT	- AC; - ENG-PTO	6 PK 1145
				ALT	OE-NO.: 93161358;4430217; + AC; + ENG-PTO	6 PK 1840
				ALT	OE-NO.: 93196393;4418809; + AC; + ENG-PTO	6 PK 1795

#### 2.5 CDTI

2463 ccm	107 kW	G9U 730	08.06 -	ALT	OE-NO.: 93195485;4418675; + AC; + ENG-PTO	7 PK 1793
				CAM		ZRK 1462
				CAM		KT 1392

**VW**
**CRAFTER 30-35 Bus (2E\_)**

<b>2.0 TDI</b>							
1968 ccm	80 kW	CKTB	05.11 -	CAM	MTR-CODE: CKTB;CKTC		ZRK 1572
<b>2.0 TDI</b>							
1968 ccm	100 kW	CKTC	05.11 -	CAM	MTR-CODE: CKTB;CKTC		ZRK 1572
<b>2.0 TDI</b>							
1968 ccm	105 kW	CKUC	10.11 -	CAM	MTR-CODE: CKUB;CKUC		ZRK 1572
<b>2.0 TDI</b>							
1968 ccm	120 kW	CKUB	07.11 -	CAM	MTR-CODE: CKUB;CKUC		ZRK 1572
<b>2.5 TDI</b>							
2461 ccm	65 kW	BJJ;CEBA	04.06 -	AC-C			4 EPK 970
				ALT	MTR-CODE: BJJ;CEBA; MOD: 30; - AC		6 PK 2000
				ALT	MTR-CODE: BJJ;CEBA; MOD: 30; + AC		6 PK 2585
				ALT	MTR-CODE: BJJ;CEBA; MOD: 35; - AC		6 PK 2000
				ALT	MTR-CODE: BJJ;CEBA; MOD: 35; + AC		6 PK 2585
				CAM			ZRK 1539
				CAM			KT 1486
<b>2.5 TDI</b>							
2461 ccm	80 kW	BJK;CEBB	04.06 -	ALT	MTR-CODE: BJK;CEBB; MOD: 30; - AC		6 PK 2000
				ALT	MTR-CODE: BJK;CEBB; MOD: 30; + AC		6 PK 2585
				ALT	MTR-CODE: BJK;CEBB; MOD: 35; - AC		6 PK 2000
				ALT	MTR-CODE: BJK;CEBB; MOD: 35; + AC		6 PK 2585
				CAM			ZRK 1539
				CAM			KT 1486
<b>2.5 TDI</b>							
2461 ccm	100 kW	BJL;CECA	04.06 -	AC-C			4 EPK 970
				ALT	MTR-CODE: BJL;CECA; MOD: 30; - AC		6 PK 2000
				ALT	MTR-CODE: BJL;CECA; MOD: 30; + AC		6 PK 2585
				ALT	MTR-CODE: BJL;CECA; MOD: 35; - AC		6 PK 2000
				ALT	MTR-CODE: BJL;CECA; MOD: 35; + AC		6 PK 2585
				CAM			ZRK 1539
				CAM			KT 1486
<b>2.5 TDI</b>							
2461 ccm	120 kW	BJM;CECB	04.06 -	AC-C			4 EPK 970
				ALT	MTR-CODE: BJM;CECB; MOD: 30; - AC		6 PK 2000
				ALT	MTR-CODE: BJM;CECB; MOD: 30; + AC		6 PK 2585
				ALT	MTR-CODE: BJM;CECB; MOD: 35; - AC		6 PK 2000
				ALT	MTR-CODE: BJM;CECB; MOD: 35; + AC		6 PK 2585
				CAM			ZRK 1539
				CAM			KT 1486

**CRAFTER 30-50 Kasten (2E\_)**

<b>2.0 TDI</b>							
1968 ccm	80 kW	CKTB	05.11 -	CAM	MTR-CODE: CKTB;CKTC		ZRK 1572
<b>2.0 TDI</b>							
1968 ccm	100 kW	CKTC	05.11 -	CAM	MTR-CODE: CKTB;CKTC		ZRK 1572
<b>2.0 TDI</b>							
1968 ccm	105 kW	CKUC	10.11 -	CAM	MTR-CODE: CKUB;CKUC		ZRK 1572
<b>2.0 TDI</b>							
1968 ccm	120 kW	CKUB	07.11 -	CAM	MTR-CODE: CKUB;CKUC		ZRK 1572
<b>2.5 TDI</b>							
2461 ccm	65 kW	BJJ;CEBA	04.06 -	ALT	MTR-CODE: BJJ;CEBA; MOD: 30; - AC		6 PK 2000
				ALT	MTR-CODE: BJJ;CEBA; MOD: 30; + AC		6 PK 2585
				ALT	MTR-CODE: BJJ;CEBA; MOD: 35; - AC		6 PK 2000
				ALT	MTR-CODE: BJJ;CEBA; MOD: 35; + AC		6 PK 2585
				CAM			ZRK 1539
				CAM			KT 1486
<b>2.5 TDI</b>							
2461 ccm	80 kW	BJK;CEBB	04.06 -	ALT	MTR-CODE: BJK;CEBB; MOD: 30; - AC		6 PK 2000
				ALT	MTR-CODE: BJK;CEBB; MOD: 30; + AC		6 PK 2585
				ALT	MTR-CODE: BJK;CEBB; MOD: 35; - AC		6 PK 2000
				ALT	MTR-CODE: BJK;CEBB; MOD: 35; + AC		6 PK 2585
				ALT	MTR-CODE: BJK;CEBB; MOD: 50; - AC		6 PK 2000
				ALT	MTR-CODE: BJK;CEBB; MOD: 50; + AC		6 PK 2585
				CAM			ZRK 1539
				CAM			KT 1486



## VW

### CRAFTER 30-50 Kasten (2E\_)

#### 2.5 TDI

2461 ccm	100 kW	BJL;CECA	04.06 -	AC-C		<b>4 EPK 970</b>
				ALT	MTR-CODE: BJL;CECA; MOD: 30; - AC	<b>6 PK 2000</b>
				ALT	MTR-CODE: BJL;CECA; MOD: 30; + AC	<b>6 PK 2585</b>
				ALT	MTR-CODE: BJL;CECA; MOD: 35; - AC	<b>6 PK 2000</b>
				ALT	MTR-CODE: BJL;CECA; MOD: 35; + AC	<b>6 PK 2585</b>
				ALT	MTR-CODE: BJL;CECA; MOD: 50; - AC	<b>6 PK 2000</b>
				ALT	MTR-CODE: BJL;CECA; MOD: 50; + AC	<b>6 PK 2585</b>
				CAM		<b>ZRK 1539</b>
				CAM		<b>KT 1486</b>

#### 2.5 TDI

2461 ccm	120 kW	BJM;CECB	04.06 -	AC-C		<b>4 EPK 970</b>
				ALT	MTR-CODE: BJM; MOD: 50; - AC	<b>6 PK 2000</b>
				ALT	MTR-CODE: BJM; MOD: 50; + AC	<b>6 PK 2585</b>
				ALT	MTR-CODE: BJM;CECB; MOD: 30; - AC	<b>6 PK 2000</b>
				ALT	MTR-CODE: BJM;CECB; MOD: 30; + AC	<b>6 PK 2585</b>
				ALT	MTR-CODE: BJM;CECB; MOD: 35; - AC	<b>6 PK 2000</b>
				ALT	MTR-CODE: BJM;CECB; MOD: 35; + AC	<b>6 PK 2585</b>
				CAM		<b>ZRK 1539</b>
				CAM		<b>KT 1486</b>

### CRAFTER 30-50 Pritsche/Fahrgestell (2F\_)

#### 2.0 TDI

1968 ccm	80 kW	CKTB	05.11 -	CAM	MTR-CODE: CKTB;CKTC	<b>ZRK 1572</b>
----------	-------	------	---------	-----	---------------------	-----------------

#### 2.0 TDI

1968 ccm	100 kW	CKTC	05.11 -	CAM	MTR-CODE: CKTB;CKTC	<b>ZRK 1572</b>
----------	--------	------	---------	-----	---------------------	-----------------

#### 2.0 TDI

1968 ccm	105 kW	CKUC	10.11 -	CAM	MTR-CODE: CKUB;CKUC	<b>ZRK 1572</b>
----------	--------	------	---------	-----	---------------------	-----------------

#### 2.0 TDI

1968 ccm	120 kW	CKUB	07.11 -	CAM	MTR-CODE: CKUB;CKUC	<b>ZRK 1572</b>
----------	--------	------	---------	-----	---------------------	-----------------

#### 2.5 TDI

2461 ccm	65 kW	BJJ;CEBA	04.06 -	ALT	MTR-CODE: BJJ;CEBA; MOD: 30; - AC	<b>6 PK 2000</b>
				ALT	MTR-CODE: BJJ;CEBA; MOD: 30; + AC	<b>6 PK 2585</b>
				ALT	MTR-CODE: BJJ;CEBA; MOD: 35; - AC	<b>6 PK 2000</b>
				ALT	MTR-CODE: BJJ;CEBA; MOD: 35; + AC	<b>6 PK 2585</b>
				CAM		<b>ZRK 1539</b>
				CAM		<b>KT 1486</b>

#### 2.5 TDI

2461 ccm	80 kW	BJK;CEBB	04.06 -	ALT	MTR-CODE: BJK;CEBB; MOD: 30; - AC	<b>6 PK 2000</b>
				ALT	MTR-CODE: BJK;CEBB; MOD: 30; + AC	<b>6 PK 2585</b>
				ALT	MTR-CODE: BJK;CEBB; MOD: 35; - AC	<b>6 PK 2000</b>
				ALT	MTR-CODE: BJK;CEBB; MOD: 35; + AC	<b>6 PK 2585</b>
				ALT	MTR-CODE: BJK;CEBB; MOD: 50; - AC	<b>6 PK 2000</b>
				ALT	MTR-CODE: BJK;CEBB; MOD: 50; + AC	<b>6 PK 2585</b>
				CAM		<b>ZRK 1539</b>
				CAM		<b>KT 1486</b>

#### 2.5 TDI

2461 ccm	100 kW	BJL;CECA	04.06 -	AC-C		<b>4 EPK 970</b>
				ALT	MTR-CODE: BJL;CECA; MOD: 30; - AC	<b>6 PK 2000</b>
				ALT	MTR-CODE: BJL;CECA; MOD: 30; + AC	<b>6 PK 2585</b>
				ALT	MTR-CODE: BJL;CECA; MOD: 35; - AC	<b>6 PK 2000</b>
				ALT	MTR-CODE: BJL;CECA; MOD: 35; + AC	<b>6 PK 2585</b>
				ALT	MTR-CODE: BJL;CECA; MOD: 50; - AC	<b>6 PK 2000</b>
				ALT	MTR-CODE: BJL;CECA; MOD: 50; + AC	<b>6 PK 2585</b>
				CAM		<b>ZRK 1539</b>
				CAM		<b>KT 1486</b>

#### 2.5 TDI

2461 ccm	120 kW	BJM;CECB	04.06 -	AC-C		<b>4 EPK 970</b>
				ALT	MTR-CODE: BJM; MOD: 50; - AC	<b>6 PK 2000</b>
				ALT	MTR-CODE: BJM; MOD: 50; + AC	<b>6 PK 2585</b>
				ALT	MTR-CODE: BJM;CECB; MOD: 30; - AC	<b>6 PK 2000</b>
				ALT	MTR-CODE: BJM;CECB; MOD: 30; + AC	<b>6 PK 2585</b>
				ALT	MTR-CODE: BJM;CECB; MOD: 35; - AC	<b>6 PK 2000</b>
				ALT	MTR-CODE: BJM;CECB; MOD: 35; + AC	<b>6 PK 2585</b>
				CAM		<b>ZRK 1539</b>
				CAM		<b>KT 1486</b>

**VW**
**LT 28-35 | Bus (281-363)**
**2.0**

1984 ccm	55 kW	CH	04.75 - 09.83	ALT		AVX 10 x 1013
				ALT	+ AC	AVX 10 x 900
				ALT	1. HYD-P	AVX 10 x 900
				HYD-P		AVX 10 x 800
				CAM		ZRK 1056
				CAM		KT 1001

**2.4**

2383 ccm	66 kW	DL	12.82 - 07.92	ALT	FROM CHA-NO.: 28G016822	AVX 10 x 800
				ALT	UNTIL CHA-NO.: 28G016821	AVX 10 x 813
				PS		AVX 13 x 800
				VAC-P		AVX 10 x 1025
				CAM	FROM CHA-NO.: 28-F-000001	ZRK 1212
				CAM	UNTIL CHA-NO.: 28-E-025000	ZRK 1048

**2.4 i**

2383 ccm	69 kW	1E	08.89 - 06.96	ALT	FROM CHA-NO.: 28G016822	AVX 10 x 800
				ALT	UNTIL CHA-NO.: 28G016821	AVX 10 x 813
				PS		AVX 13 x 800
				VAC-P		AVX 10 x 1025
				CAM	FROM CHA-NO.: 28-F-000001	ZRK 1212
				CAM	UNTIL CHA-NO.: 28-E-025000	ZRK 1048

**2.4 D**

2383 ccm	51 kW	1S;ACT	08.89 - 06.96	ALT	FROM CHA-NO.: 28G016822	AVX 10 x 800
				ALT	UNTIL CHA-NO.: 28G016821	AVX 10 x 813
				PS	UNTIL: 07.92	AVX 13 x 800
				VAC-P		AVX 10 x 1025
				CAM		ZRK 1376
				CAM	MTR-CODE: ACL;ACT	ZRK 1240
				INJ-P		ZRK 1090
				CAM	MTR-CODE: 1S	KT 1090

**2.4 D**

2383 ccm	55 kW	CP;DW	01.79 - 07.92	ALT	FROM CHA-NO.: 28G016822	AVX 10 x 800
				ALT	UNTIL CHA-NO.: 28G016821	AVX 10 x 813
				PS		AVX 13 x 800
				VAC-P		AVX 10 x 1025
				CAM		ZRK 1376
				INJ-P		ZRK 1090
				CAM		KT 1090

**2.4 TD**

2383 ccm	68 kW	1G	08.89 - 08.92	ALT	FROM CHA-NO.: 28G016822	AVX 10 x 800
				ALT	UNTIL CHA-NO.: 28G016821	AVX 10 x 813
				PS		AVX 13 x 800
				VAC-P		AVX 10 x 1025
				CAM		ZRK 1376
				INJ-P		ZRK 1090
				CAM		KT 1090

**2.4 TD**

2383 ccm	70 kW	ACL	09.92 - 06.96	ALT	FROM CHA-NO.: 28G016822	AVX 10 x 800
				ALT	UNTIL CHA-NO.: 28G016821	AVX 10 x 813
				PS		AVX 13 x 800
				VAC-P		AVX 10 x 1025
				CAM	MTR-CODE: ACL;ACT	ZRK 1240
				INJ-P		ZRK 1090

**2.4 TD**

2383 ccm	75 kW	DV	12.82 - 07.89	ALT	FROM CHA-NO.: 28G016822	AVX 10 x 800
				ALT	UNTIL CHA-NO.: 28G016821	AVX 10 x 813
				PS		AVX 13 x 800
				VAC-P		AVX 10 x 1025
				CAM		ZRK 1376
				INJ-P		ZRK 1090
				CAM		KT 1090

**LT 28-35 | Kasten (281-363)**
**2.0**

1984 ccm	55 kW	CH	04.75 - 09.83	ALT		AVX 10 x 1013
				ALT	+ AC	AVX 10 x 900
				ALT	1. HYD-P	AVX 10 x 900



## VW

### LT 28-35 | Kasten (281-363)

<b>2.0</b>						
1984 ccm	55 kW	CH	04.75 - 09.83	HYD-P CAM		AVX 10 x 800 ZRK 1056
<b>2.4</b>						
2383 ccm	66 kW	DL	12.82 - 07.92	ALT ALT PS VAC-P CAM CAM	FROM CHA-NO.: 28G016822 UNTIL CHA-NO.: 28G016821  FROM CHA-NO.: 28-F-000001 UNTIL CHA-NO.: 28-E-025000	AVX 10 x 800 AVX 10 x 813 AVX 13 x 800 AVX 10 x 1025 ZRK 1212 ZRK 1048
<b>2.4 D</b>						
2383 ccm	51 kW	1S;ACT	07.90 - 05.96	ALT ALT PS VAC-P CAM CAM INJ-P CAM	FROM CHA-NO.: 28G016822 UNTIL CHA-NO.: 28G016821  MTR-CODE: ACL;ACT  MTR-CODE: 1S	AVX 10 x 800 AVX 10 x 813 AVX 13 x 800 AVX 10 x 1025 ZRK 1376 ZRK 1240 ZRK 1090 KT 1090
<b>2.4 D</b>						
2383 ccm	55 kW	CP;DW	01.79 - 07.92	ALT ALT PS VAC-P CAM INJ-P CAM	FROM CHA-NO.: 28G016822 UNTIL CHA-NO.: 28G016821	AVX 10 x 800 AVX 10 x 813 AVX 13 x 800 AVX 10 x 1025 ZRK 1376 ZRK 1090 KT 1090
<b>2.4 TD</b>						
2383 ccm	68 kW	1G	08.88 - 08.92	ALT ALT PS VAC-P CAM INJ-P CAM	FROM CHA-NO.: 28G016822 UNTIL CHA-NO.: 28G016821	AVX 10 x 800 AVX 10 x 813 AVX 13 x 800 AVX 10 x 1025 ZRK 1376 ZRK 1090 KT 1090
<b>2.4 TD</b>						
2383 ccm	70 kW	ACL	06.92 - 05.96	ALT ALT PS VAC-P CAM INJ-P	FROM CHA-NO.: 28G016822 UNTIL CHA-NO.: 28G016821  MTR-CODE: ACL;ACT	AVX 10 x 800 AVX 10 x 813 AVX 13 x 800 AVX 10 x 1025 ZRK 1240 ZRK 1090
<b>2.4 TD Syncro</b>						
2383 ccm	70 kW	ACL	08.92 - 04.96	CAM INJ-P		ZRK 1240 ZRK 1090
<b>2.4 TD</b>						
2383 ccm	75 kW	DV	02.86 - 08.92	ALT ALT PS VAC-P CAM INJ-P CAM	FROM CHA-NO.: 28G016822 UNTIL CHA-NO.: 28G016821	AVX 10 x 800 AVX 10 x 813 AVX 13 x 800 AVX 10 x 1025 ZRK 1376 ZRK 1090 KT 1090

### LT 28-35 | Pritsche/Fahrgestell (281-363)

<b>2.0</b>						
1984 ccm	55 kW	CH	04.75 - 09.83	ALT ALT ALT HYD-P CAM	+ AC 1. HYD-P	AVX 10 x 1013 AVX 10 x 900 AVX 10 x 900 AVX 10 x 800 ZRK 1056
<b>2.4 D</b>						
2383 ccm	51 kW	1S;ACT	08.90 - 06.96	ALT ALT PS VAC-P CAM	FROM CHA-NO.: 28G016822 UNTIL CHA-NO.: 28G016821	AVX 10 x 800 AVX 10 x 813 AVX 13 x 800 AVX 10 x 1025 ZRK 1376

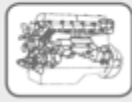
**VW**
**LT 28-35 | Pritsche/Fahrgestell (281-363)**

<b>2.4 D</b>						
2383 ccm	51 kW	1S;ACT	08.90 - 06.96	CAM INJ-P CAM	MTR-CODE: ACL;ACT  MTR-CODE: 1S	ZRK 1240 ZRK 1090 KT 1090
<b>2.4 D</b>						
2383 ccm	55 kW	CP;DW	12.78 - 02.91	ALT ALT PS VAC-P CAM INJ-P CAM	FROM CHA-NO.: 28G016822 UNTIL CHA-NO.: 28G016821	AVX 10 x 800 AVX 10 x 813 AVX 13 x 800 AVX 10 x 1025 ZRK 1376 ZRK 1090 KT 1090
<b>2.4 TD</b>						
2383 ccm	68 kW	1G	08.90 - 08.92	ALT ALT PS VAC-P CAM INJ-P CAM	FROM CHA-NO.: 28G016822 UNTIL CHA-NO.: 28G016821	AVX 10 x 800 AVX 10 x 813 AVX 13 x 800 AVX 10 x 1025 ZRK 1376 ZRK 1090 KT 1090
<b>2.4 TD</b>						
2383 ccm	70 kW	ACL	08.92 - 06.96	ALT PS VAC-P CAM INJ-P	FROM CHA-NO.: 28G016822  MTR-CODE: ACL;ACT	AVX 10 x 813 AVX 10 x 800 AVX 13 x 800 AVX 10 x 1025 ZRK 1240 ZRK 1090
<b>2.4 TD Syncro</b>						
2383 ccm	70 kW	ACL	08.92 - 04.96	CAM INJ-P		ZRK 1240 ZRK 1090
<b>2.4 TD</b>						
2383 ccm	75 kW	DV	12.82 - 09.93	CAM		KT 1090

**LT 40-55 | Kasten (291-512)**

<b>2.4 D</b>						
2383 ccm	51 kW	1S;ACT	07.90 - 05.96	CAM	MTR-CODE: 1S	KT 1090
<b>2.4 D</b>						
2383 ccm	55 kW	CP;DW	01.79 - 07.92	CAM INJ-P CAM		ZRK 1376 ZRK 1090 KT 1090
<b>2.4 D 4WD</b>						
2383 ccm	55 kW	DW	01.79 - 03.86	CAM		KT 1090
<b>2.4 TD</b>						
2383 ccm	68 kW	1G	08.88 - 08.92	CAM		KT 1090
<b>2.4 TD</b>						
2383 ccm	70 kW	ACL	06.92 - 05.96	CAM INJ-P	MTR-CODE: ACL;ACT	ZRK 1240 ZRK 1090
<b>2.4 TD Syncro</b>						
2383 ccm	70 kW	ACL	08.92 - 04.96	CAM INJ-P		ZRK 1240 ZRK 1090
<b>2.4 TD</b>						
2383 ccm	75 kW	DV	02.86 - 08.92	CAM		KT 1090
<b>2.4 TD 4WD</b>						
2383 ccm	75 kW	DV	08.78 - 07.92	CAM		KT 1090

**LT 40-55 | Pritsche/Fahrgestell (293-909)**

<b>2.4 D</b>						
2383 ccm	51 kW	1S;ACT	08.90 - 06.96	CAM	MTR-CODE: 1S	KT 1090
<b>2.4 D</b>						
2383 ccm	55 kW	CP;DW	12.78 - 02.91	CAM INJ-P CAM		ZRK 1376 ZRK 1090 KT 1090
<b>2.4 TD</b>						
2383 ccm	70 kW	ACL	08.92 - 06.96	CAM INJ-P	MTR-CODE: ACL;ACT	ZRK 1240 ZRK 1090





## VW

### LT 40-55 I Pritsche/Fahrgestell (293-909)

#### 2.4 TD Syncro

2383 ccm	70 kW	ACL	08.92 - 04.96	CAM		<b>ZRK 1240</b>
				INJ-P		<b>ZRK 1090</b>

#### 2.4 TD

2383 ccm	75 kW	DV	12.82 - 09.93	CAM		<b>KT 1090</b>
----------	-------	----	---------------	-----	--	----------------

### LT 28-35 II Bus (2DM)

#### 2.3

2295 ccm	105 kW	AGL	05.96 - 07.06	ALT	OE-NO.: 00A260849; MOD: LT28; + AC	<b>6 PK 2205</b>
				ALT	OE-NO.: 00A260849; MOD: LT35; + AC	<b>6 PK 2205</b>
				ALT	OE-NO.: 00A903137; MOD: LT28; - AC	<b>6 PK 2100</b>
				ALT	OE-NO.: 00A903137; MOD: LT35; - AC	<b>6 PK 2100</b>
				ALT	OE-NO.: 2D0145933A; MOD: LT28; - AC	<b>6 PK 2115</b>
				ALT	OE-NO.: 2D0145933A; MOD: LT35; - AC	<b>6 PK 2115</b>
				ALT	OE-NO.: 2D0260849; MOD: LT28; + AC	<b>6 PK 2215</b>
				ALT	OE-NO.: 2D0260849; MOD: LT35; + AC	<b>6 PK 2215</b>

#### 2.5 SDI

2461 ccm	55 kW	AGX	07.96 - 07.06	ALT	FROM CHA-NO.: 2D-Y-009087; MOD: LT28; - AC	<b>6 PK 1718</b>
				ALT	FROM CHA-NO.: 2D-Y-009087; MOD: LT35; - AC	<b>6 PK 1718</b>
				ALT	FROM CHA-NO.: 2D-Y-009207; MOD: LT28; + AC	<b>6 PK 2145</b>
				ALT	FROM CHA-NO.: 2D-Y-009207; MOD: LT35; + AC	<b>6 PK 2145</b>
				ALT	OE-NO.: 074903137AR; MOD: LT28; 2. ALT; 2 ALT	<b>6 PK 2100</b>
				ALT	OE-NO.: 074903137AR; MOD: LT35; 2. ALT; 2 ALT	<b>6 PK 2100</b>
				ALT	OE-NO.: 074903137BC; MOD: LT28; 2. ALT; 2 ALT	<b>6 PK 2115</b>
				ALT	OE-NO.: 074903137BC; MOD: LT35; 2. ALT; 2 ALT	<b>6 PK 2115</b>
				ALT	UNTIL CHA-NO.: 2D-Y-009086; MOD: LT28; - AC	<b>6 PK 1751</b>
				ALT	UNTIL CHA-NO.: 2D-Y-009086; MOD: LT35; - AC	<b>6 PK 1751</b>
				ALT	UNTIL CHA-NO.: 2D-Y-009206; MOD: LT28; + AC	<b>6 PK 2170</b>
				ALT	UNTIL CHA-NO.: 2D-Y-009206; MOD: LT35; + AC	<b>6 PK 2170</b>
				CAM		<b>ZRK 1301</b>
				INJ-P		<b>ZRK 1238</b>
				CAM		<b>KT 1218</b>
				CAM		<b>KT 1302</b>
				CAM; INJ-P		<b>KT 1515</b>
				W-P; CAM		<b>KT 1218 W1</b>

#### 2.5 TDI

2461 ccm	61 kW	BBE	05.01 - 07.06	ALT	FROM CHA-NO.: 2D-Y-009087; MTR-CODE: BBE;BBF; MOD: LT28; 1. ALT; 2 ALT	<b>6 PK 1718</b>
				ALT	FROM CHA-NO.: 2D-Y-009087; MTR-CODE: BBE;BBF; MOD: LT32; 1. ALT; 2 ALT	<b>6 PK 1718</b>
				ALT	FROM CHA-NO.: 2D-Y-009087; MTR-CODE: BBE;BBF; MOD: LT35; 1. ALT; 2 ALT	<b>6 PK 1718</b>
				ALT	FROM CHA-NO.: 2D-Y-009087; MTR-CODE: BBE;BBF; MOD: LT46; 1. ALT; 2 ALT	<b>6 PK 1718</b>
				ALT	MTR-CODE: BBE;BBF; MOD: LT28; + AC	<b>6 PK 2145</b>
				ALT	MTR-CODE: BBE;BBF; MOD: LT28; 2. ALT; 2 ALT	<b>6 PK 2080</b>
				ALT	MTR-CODE: BBE;BBF; MOD: LT32; + AC	<b>6 PK 2145</b>
				ALT	MTR-CODE: BBE;BBF; MOD: LT32; 2. ALT; 2 ALT	<b>6 PK 2080</b>
				ALT	MTR-CODE: BBE;BBF; MOD: LT35; + AC	<b>6 PK 2145</b>
				ALT	MTR-CODE: BBE;BBF; MOD: LT35; 2. ALT; 2 ALT	<b>6 PK 2080</b>
				ALT	MTR-CODE: BBE;BBF; MOD: LT46; + AC	<b>6 PK 2145</b>
				ALT	MTR-CODE: BBE;BBF; MOD: LT46; 2. ALT; 2 ALT	<b>6 PK 2080</b>
				ALT	UNTIL CHA-NO.: 2D-Y-009086; MTR-CODE: BBE;BBF; MOD: LT28; 1. ALT; 2 ALT	<b>6 PK 1751</b>
				ALT	UNTIL CHA-NO.: 2D-Y-009086; MTR-CODE: BBE;BBF; MOD: LT32; 1. ALT; 2 ALT	<b>6 PK 1751</b>

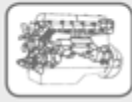

## VW

### LT 28-35 II Bus (2DM)

2.5 TDI						
2461 ccm	61 kW	BBE	05.01 - 07.06	ALT	UNTIL CHA-NO.: 2D-Y-009086; MTR-CODE: BBE;BBF; MOD: LT35; 1. ALT; 2 ALT	6 PK 1751
				ALT	UNTIL CHA-NO.: 2D-Y-009086; MTR-CODE: BBE;BBF; MOD: LT46; 1. ALT; 2 ALT	6 PK 1751
				CAM		ZRK 1301
				INJ-P		ZRK 1238
				CAM		KT 1214
				CAM		KT 1302
				CAM	UNTIL: 04.06	KT 1442
				W-P; CAM	UNTIL CHA-NO.: 2D-6-020000	KT 1214 W1

2.5 TDI						
2461 ccm	66 kW	APA	05.99 - 07.06	ALT	FROM CHA-NO.: 2D-Y-009087; MTR-CODE: AHD;ANJ;APA;AVR; MOD: LT28; - AC	6 PK 1718
				ALT	FROM CHA-NO.: 2D-Y-009087; MTR-CODE: AHD;ANJ;APA;AVR; MOD: LT35; - AC	6 PK 1718
				ALT	FROM CHA-NO.: 2D-Y-009087; MTR-CODE: AHD;ANJ;APA;AVR; MOD: LT46; - AC	6 PK 1718
				ALT	FROM CHA-NO.: 2D-Y-009207; MTR-CODE: AHD;ANJ;APA;AVR; MOD: LT28; + AC	6 PK 2145
				ALT	FROM CHA-NO.: 2D-Y-009207; MTR-CODE: AHD;ANJ;APA;AVR; MOD: LT35; + AC; - MTR-CODE: AHD	6 PK 2145
				ALT	FROM CHA-NO.: 2D-Y-009207; MTR-CODE: AHD;ANJ;APA;AVR; MOD: LT46; + AC; - MTR-CODE: AHD	6 PK 2145
				ALT	MTR-CODE: AHD;ANJ;APA;AVR; OE-NO.: 074903137AR; MOD: LT28; 2. ALT; 2 ALT	6 PK 2100
				ALT	MTR-CODE: AHD;ANJ;APA;AVR; OE-NO.: 074903137AR; MOD: LT35; 2. ALT; 2 ALT	6 PK 2100
				ALT	MTR-CODE: AHD;ANJ;APA;AVR; OE-NO.: 074903137AR; MOD: LT46; 2. ALT; 2 ALT	6 PK 2100
				ALT	MTR-CODE: AHD;ANJ;APA;AVR; OE-NO.: 074903137BC; MOD: LT28; 2. ALT; 2 ALT	6 PK 2115
				ALT	MTR-CODE: AHD;ANJ;APA;AVR; OE-NO.: 074903137BC; MOD: LT35; 2. ALT; 2 ALT	6 PK 2115
				ALT	MTR-CODE: AHD;ANJ;APA;AVR; OE-NO.: 074903137BC; MOD: LT46; 2. ALT; 2 ALT	6 PK 2115
				ALT	UNTIL CHA-NO.: 2D-Y-009086; MTR-CODE: AHD;ANJ;APA;AVR; MOD: LT28; - AC	6 PK 1751
				ALT	UNTIL CHA-NO.: 2D-Y-009086; MTR-CODE: AHD;ANJ;APA;AVR; MOD: LT35; - AC	6 PK 1751
				ALT	UNTIL CHA-NO.: 2D-Y-009086; MTR-CODE: AHD;ANJ;APA;AVR; MOD: LT46; - AC	6 PK 1751
				ALT	UNTIL CHA-NO.: 2D-Y-009206; MTR-CODE: AHD;ANJ;APA;AVR; MOD: LT28; + AC	6 PK 2170
				ALT	UNTIL CHA-NO.: 2D-Y-009206; MTR-CODE: AHD;ANJ;APA;AVR; MOD: LT35; + AC	6 PK 2170
				ALT	UNTIL CHA-NO.: 2D-Y-009206; MTR-CODE: AHD;ANJ;APA;AVR; MOD: LT46; + AC	6 PK 2170
				CAM		ZRK 1301
				INJ-P		ZRK 1238
				CAM		KT 1214
				CAM		KT 1302
				CAM	UNTIL: 04.01	KT 1442
				W-P; CAM		KT 1214 W1

2.5 TDI						
2461 ccm	70 kW	BBF	05.01 - 07.06	ALT	FROM CHA-NO.: 2D-Y-009087; MTR-CODE: BBE;BBF; MOD: LT28; 1. ALT; 2 ALT	6 PK 1718
				ALT	FROM CHA-NO.: 2D-Y-009087; MTR-CODE: BBE;BBF; MOD: LT32; 1. ALT; 2 ALT	6 PK 1718
				ALT	FROM CHA-NO.: 2D-Y-009087; MTR-CODE: BBE;BBF; MOD: LT35; 1. ALT; 2 ALT	6 PK 1718
				ALT	FROM CHA-NO.: 2D-Y-009087; MTR-CODE: BBE;BBF; MOD: LT46; 1. ALT; 2 ALT	6 PK 1718
				ALT	MTR-CODE: BBE;BBF; MOD: LT28; + AC	6 PK 2145
				ALT	MTR-CODE: BBE;BBF; MOD: LT28; 2. ALT; 2 ALT	6 PK 2080
				ALT	MTR-CODE: BBE;BBF; MOD: LT32; + AC	6 PK 2145
				ALT	MTR-CODE: BBE;BBF; MOD: LT32; 2. ALT; 2 ALT	6 PK 2080
				ALT	MTR-CODE: BBE;BBF; MOD: LT35; + AC	6 PK 2145



## VW

### LT 28-35 II Bus (2DM)

#### 2.5 TDI

2461 ccm	70 kW	BBF	05.01 - 07.06	ALT	MTR-CODE: BBE;BBF; MOD: LT35; 2. ALT; 2 ALT	<b>6 PK 2080</b>
				ALT	MTR-CODE: BBE;BBF; MOD: LT46; + AC	<b>6 PK 2145</b>
				ALT	MTR-CODE: BBE;BBF; MOD: LT46; 2. ALT; 2 ALT	<b>6 PK 2080</b>
				ALT	UNTIL CHA-NO.: 2D-Y-009086; MTR-CODE: BBE;BBF; MOD: LT28; 1. ALT; 2 ALT	<b>6 PK 1751</b>
				ALT	UNTIL CHA-NO.: 2D-Y-009086; MTR-CODE: BBE;BBF; MOD: LT32; 1. ALT; 2 ALT	<b>6 PK 1751</b>
				ALT	UNTIL CHA-NO.: 2D-Y-009086; MTR-CODE: BBE;BBF; MOD: LT35; 1. ALT; 2 ALT	<b>6 PK 1751</b>
				ALT	UNTIL CHA-NO.: 2D-Y-009086; MTR-CODE: BBE;BBF; MOD: LT46; 1. ALT; 2 ALT	<b>6 PK 1751</b>
				CAM		<b>ZRK 1301</b>
				INJ-P		<b>ZRK 1238</b>
				CAM		<b>KT 1214</b>
				CAM		<b>KT 1302</b>
				CAM	UNTIL: 04.06	<b>KT 1442</b>
				W-P; CAM	UNTIL CHA-NO.: 2D-6-020000	<b>KT 1214 W1</b>

#### 2.5 TDI

2461 ccm	75 kW	AHD	05.96 - 08.99	ALT	FROM CHA-NO.: 2D-Y-009087; MTR-CODE: AHD;ANJ;APA;AVR; MOD: LT28; - AC	<b>6 PK 1718</b>
				ALT	FROM CHA-NO.: 2D-Y-009087; MTR-CODE: AHD;ANJ;APA;AVR; MOD: LT35; - AC	<b>6 PK 1718</b>
				ALT	FROM CHA-NO.: 2D-Y-009207; MTR-CODE: AHD;ANJ;APA;AVR; MOD: LT28; + AC	<b>6 PK 2145</b>
				ALT	FROM CHA-NO.: 2D-Y-009207; MTR-CODE: AHD;ANJ;APA;AVR; MOD: LT35; + AC; - MTR-CODE: AHD	<b>6 PK 2145</b>
				ALT	FROM: 12.96; FROM CHA-NO.: 2D-Y-009087; MTR-CODE: AHD;ANJ;APA;AVR; MOD: LT46; - AC	<b>6 PK 1718</b>
				ALT	FROM: 12.96; FROM CHA-NO.: 2D-Y-009207; MTR-CODE: AHD;ANJ;APA;AVR; MOD: LT46; + AC; - MTR-CODE: AHD	<b>6 PK 2145</b>
				ALT	FROM: 12.96; MTR-CODE: AHD;ANJ;APA;AVR; OE-NO.: 074903137AR; MOD: LT46; 2. ALT; 2 ALT	<b>6 PK 2100</b>
				ALT	FROM: 12.96; MTR-CODE: AHD;ANJ;APA;AVR; OE-NO.: 074903137BC; MOD: LT46; 2. ALT; 2 ALT	<b>6 PK 2115</b>
				ALT	FROM: 12.96; UNTIL CHA-NO.: 2D-Y-009086; MTR-CODE: AHD;ANJ;APA;AVR; MOD: LT46; - AC	<b>6 PK 1751</b>
				ALT	FROM: 12.96; UNTIL CHA-NO.: 2D-Y-009206; MTR-CODE: AHD;ANJ;APA;AVR; MOD: LT46; + AC	<b>6 PK 2170</b>
				ALT	MTR-CODE: AHD;ANJ;APA;AVR; OE-NO.: 074903137AR; MOD: LT28; 2. ALT; 2 ALT	<b>6 PK 2100</b>
				ALT	MTR-CODE: AHD;ANJ;APA;AVR; OE-NO.: 074903137AR; MOD: LT35; 2. ALT; 2 ALT	<b>6 PK 2100</b>
				ALT	MTR-CODE: AHD;ANJ;APA;AVR; OE-NO.: 074903137BC; MOD: LT28; 2. ALT; 2 ALT	<b>6 PK 2115</b>
				ALT	MTR-CODE: AHD;ANJ;APA;AVR; OE-NO.: 074903137BC; MOD: LT35; 2. ALT; 2 ALT	<b>6 PK 2115</b>
				ALT	UNTIL CHA-NO.: 2D-Y-009086; MTR-CODE: AHD;ANJ;APA;AVR; MOD: LT28; - AC	<b>6 PK 1751</b>
				ALT	UNTIL CHA-NO.: 2D-Y-009086; MTR-CODE: AHD;ANJ;APA;AVR; MOD: LT35; - AC	<b>6 PK 1751</b>
				ALT	UNTIL CHA-NO.: 2D-Y-009206; MTR-CODE: AHD;ANJ;APA;AVR; MOD: LT28; + AC	<b>6 PK 2170</b>
				ALT	UNTIL CHA-NO.: 2D-Y-009206; MTR-CODE: AHD;ANJ;APA;AVR; MOD: LT35; + AC	<b>6 PK 2170</b>
				CAM		<b>ZRK 1301</b>
				INJ-P		<b>ZRK 1238</b>
				CAM		<b>KT 1214</b>
				CAM		<b>KT 1302</b>
				CAM	UNTIL: 05.99	<b>KT 1442</b>
				W-P; CAM		<b>KT 1214 W1</b>

#### 2.5 TDI

2461 ccm	80 kW	ANJ;AVR	05.99 - 07.06	ALT	FROM CHA-NO.: 2D-Y-009087; MTR-CODE: AHD;ANJ;APA;AVR; MOD: LT28; - AC	<b>6 PK 1718</b>
----------	-------	---------	---------------	-----	---	------------------

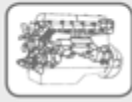
**VW**
**LT 28-35 II Bus (2DM)**

<b>2.5 TDI</b>						
2461 ccm	80 kW	ANJ;AVR	05.99 - 07.06	ALT	FROM CHA-NO.: 2D-Y-009087; MTR-CODE: AHD;ANJ;APA;AVR; MOD: LT35; - AC	<b>6 PK 1718</b>
				ALT	FROM CHA-NO.: 2D-Y-009087; MTR-CODE: AHD;ANJ;APA;AVR; MOD: LT46; - AC	<b>6 PK 1718</b>
				ALT	FROM CHA-NO.: 2D-Y-009207; MTR-CODE: AHD;ANJ;APA;AVR; MOD: LT28; + AC	<b>6 PK 2145</b>
				ALT	FROM CHA-NO.: 2D-Y-009207; MTR-CODE: AHD;ANJ;APA;AVR; MOD: LT35; + AC; - MTR-CODE: AHD	<b>6 PK 2145</b>
				ALT	FROM CHA-NO.: 2D-Y-009207; MTR-CODE: AHD;ANJ;APA;AVR; MOD: LT46; + AC; - MTR-CODE: AHD	<b>6 PK 2145</b>
				ALT	FROM: 05.01; FROM CHA-NO.: 2D-Y-009087; MTR-CODE: ANJ;AVR; MOD: LT32; - AC	<b>6 PK 1718</b>
				ALT	FROM: 05.01; MTR-CODE: ANJ;AVR; MOD: LT32; + AC	<b>6 PK 2145</b>
				ALT	FROM: 05.01; MTR-CODE: ANJ;AVR; OE-NO.: 074903137AR; MOD: LT32; 2. ALT; 2 ALT	<b>6 PK 2100</b>
				ALT	FROM: 05.01; MTR-CODE: ANJ;AVR; OE-NO.: 074903137BC; MOD: LT32; 2. ALT; 2 ALT	<b>6 PK 2115</b>
				ALT	FROM: 05.01; UNTIL CHA-NO.: 2D-Y-009086; MTR-CODE: ANJ;AVR; MOD: LT32; - AC	<b>6 PK 1751</b>
				ALT	MTR-CODE: AHD;ANJ;APA;AVR; OE-NO.: 074903137AR; MOD: LT28; 2. ALT; 2 ALT	<b>6 PK 2100</b>
				ALT	MTR-CODE: AHD;ANJ;APA;AVR; OE-NO.: 074903137AR; MOD: LT35; 2. ALT; 2 ALT	<b>6 PK 2100</b>
				ALT	MTR-CODE: AHD;ANJ;APA;AVR; OE-NO.: 074903137AR; MOD: LT46; 2. ALT; 2 ALT	<b>6 PK 2100</b>
				ALT	MTR-CODE: AHD;ANJ;APA;AVR; OE-NO.: 074903137BC; MOD: LT28; 2. ALT; 2 ALT	<b>6 PK 2115</b>
				ALT	MTR-CODE: AHD;ANJ;APA;AVR; OE-NO.: 074903137BC; MOD: LT35; 2. ALT; 2 ALT	<b>6 PK 2115</b>
				ALT	MTR-CODE: AHD;ANJ;APA;AVR; OE-NO.: 074903137BC; MOD: LT46; 2. ALT; 2 ALT	<b>6 PK 2115</b>
				ALT	UNTIL CHA-NO.: 2D-Y-009086; MTR-CODE: AHD;ANJ;APA;AVR; MOD: LT28; - AC	<b>6 PK 1751</b>
				ALT	UNTIL CHA-NO.: 2D-Y-009086; MTR-CODE: AHD;ANJ;APA;AVR; MOD: LT35; - AC	<b>6 PK 1751</b>
				ALT	UNTIL CHA-NO.: 2D-Y-009086; MTR-CODE: AHD;ANJ;APA;AVR; MOD: LT46; - AC	<b>6 PK 1751</b>
				ALT	UNTIL CHA-NO.: 2D-Y-009206; MTR-CODE: AHD;ANJ;APA;AVR; MOD: LT28; + AC	<b>6 PK 2170</b>
				ALT	UNTIL CHA-NO.: 2D-Y-009206; MTR-CODE: AHD;ANJ;APA;AVR; MOD: LT35; + AC	<b>6 PK 2170</b>
				ALT	UNTIL CHA-NO.: 2D-Y-009206; MTR-CODE: AHD;ANJ;APA;AVR; MOD: LT46; + AC	<b>6 PK 2170</b>
				CAM		<b>ZRK 1301</b>
				INJ-P		<b>ZRK 1238</b>
				CAM		<b>KT 1214</b>
				CAM		<b>KT 1302</b>
				CAM	UNTIL: 04.06	<b>KT 1442</b>
				W-P; CAM		<b>KT 1214 W1</b>
<b>2.8 TDi</b>						
2798 ccm	92 kW	AGK	02.97 - 12.98	ALT	MTR-CODE: AGK;ATA; MOD: LT28; - AC	<b>6 PK 1642</b>
				ALT	MTR-CODE: AGK;ATA; MOD: LT28; + AC	<b>6 PK 2130</b>
				ALT	MTR-CODE: AGK;ATA; MOD: LT28; 2. ALT; 2 ALT	<b>6 PK 2000</b>
				ALT	MTR-CODE: AGK;ATA; MOD: LT35; - AC	<b>6 PK 1642</b>
				ALT	MTR-CODE: AGK;ATA; MOD: LT35; + AC	<b>6 PK 2130</b>
				ALT	MTR-CODE: AGK;ATA; MOD: LT35; 2. ALT; 2 ALT	<b>6 PK 2000</b>
<b>2.8 TDi</b>						
2798 ccm	96 kW	ATA	01.99 - 01.02	ALT	MTR-CODE: AGK;ATA; MOD: LT28; - AC	<b>6 PK 1642</b>
				ALT	MTR-CODE: AGK;ATA; MOD: LT28; + AC	<b>6 PK 2130</b>
				ALT	MTR-CODE: AGK;ATA; MOD: LT28; 2. ALT; 2 ALT	<b>6 PK 2000</b>
				ALT	MTR-CODE: AGK;ATA; MOD: LT35; - AC	<b>6 PK 1642</b>
				ALT	MTR-CODE: AGK;ATA; MOD: LT35; + AC	<b>6 PK 2130</b>
				ALT	MTR-CODE: AGK;ATA; MOD: LT35; 2. ALT; 2 ALT	<b>6 PK 2000</b>
				ALT	MTR-CODE: AGK;ATA; MOD: LT46; - AC	<b>6 PK 1642</b>
				ALT	MTR-CODE: AGK;ATA; MOD: LT46; + AC	<b>6 PK 2130</b>



## VW

### LT 28-35 II Bus (2DM)

#### 2.8 TDi

2798 ccm 96 kW ATA 01.99 - 01.02 ALT MTR-CODE: AGK;ATA; MOD: LT46; 2. ALT; 2 ALT **6 PK 2000**

#### 2.8 TDi

2798 ccm 116 kW BCQ 05.01 - 06.06 ALT FROM: 06.03; MTR-CODE: BCQ; MOD: LT32; - AC **6 PK 1685**  
 ALT FROM: 06.03; MTR-CODE: BCQ; MOD: LT32; + AC **6 PK 2155**  
 ALT MTR-CODE: AUH;BCQ; MOD: LT28; - AC **6 PK 1685**  
 ALT MTR-CODE: AUH;BCQ; MOD: LT28; + AC **6 PK 2155**  
 ALT MTR-CODE: AUH;BCQ; MOD: LT35; - AC **6 PK 1685**  
 ALT MTR-CODE: AUH;BCQ; MOD: LT35; + AC **6 PK 2155**  
 ALT MTR-CODE: AUH;BCQ; MOD: LT46; - AC **6 PK 1685**  
 ALT MTR-CODE: AUH;BCQ; MOD: LT46; + AC **6 PK 2155**

### LT 28-46 II Kasten (2DX0AE)

#### 2.3

2295 ccm 105 kW AGL 05.96 - 07.06 ALT FROM: 12.96; OE-NO.: 00A260849; MOD: LT46; + AC **6 PK 2205**  
 ALT FROM: 12.96; OE-NO.: 00A903137; MOD: LT46; - AC **6 PK 2100**  
 ALT FROM: 12.96; OE-NO.: 2D0145933A; MOD: LT46; - AC **6 PK 2115**  
 ALT FROM: 12.96; OE-NO.: 2D0260849; MOD: LT46; + AC **6 PK 2215**  
 ALT OE-NO.: 00A260849; MOD: LT28; + AC **6 PK 2205**  
 ALT OE-NO.: 00A260849; MOD: LT35; + AC **6 PK 2205**  
 ALT OE-NO.: 00A903137; MOD: LT28; - AC **6 PK 2100**  
 ALT OE-NO.: 00A903137; MOD: LT35; - AC **6 PK 2100**  
 ALT OE-NO.: 2D0145933A; MOD: LT28; - AC **6 PK 2115**  
 ALT OE-NO.: 2D0145933A; MOD: LT35; - AC **6 PK 2115**  
 ALT OE-NO.: 2D0260849; MOD: LT28; + AC **6 PK 2215**  
 ALT OE-NO.: 2D0260849; MOD: LT35; + AC **6 PK 2215**

#### 2.5 SDI

2461 ccm 55 kW AGX 09.96 - 07.06 ALT FROM CHA-NO.: 2D-Y-009087; MOD: LT28; - AC **6 PK 1718**  
 ALT FROM CHA-NO.: 2D-Y-009087; MOD: LT35; - AC **6 PK 1718**  
 ALT FROM CHA-NO.: 2D-Y-009207; MOD: LT28; + AC **6 PK 2145**  
 ALT FROM CHA-NO.: 2D-Y-009207; MOD: LT35; + AC **6 PK 2145**  
 ALT OE-NO.: 074903137AR; MOD: LT28; 2. ALT; 2 ALT **6 PK 2100**  
 ALT OE-NO.: 074903137AR; MOD: LT35; 2. ALT; 2 ALT **6 PK 2100**  
 ALT OE-NO.: 074903137BC; MOD: LT28; 2. ALT; 2 ALT **6 PK 2115**  
 ALT OE-NO.: 074903137BC; MOD: LT35; 2. ALT; 2 ALT **6 PK 2115**  
 ALT UNTIL CHA-NO.: 2D-Y-009086; MOD: LT28; - AC **6 PK 1751**  
 ALT UNTIL CHA-NO.: 2D-Y-009086; MOD: LT35; - AC **6 PK 1751**  
 ALT UNTIL CHA-NO.: 2D-Y-009206; MOD: LT28; + AC **6 PK 2170**  
 ALT UNTIL CHA-NO.: 2D-Y-009206; MOD: LT35; + AC **6 PK 2170**  
 CAM **ZRK 1301**  
 INJ-P **ZRK 1238**  
 CAM **KT 1218**  
 CAM **KT 1302**  
 CAM **KT 1515**  
 W-P; CAM **KT 1218 W1**

#### 2.5 TDi

2461 ccm 61 kW BBE 05.01 - 07.06 ALT FROM CHA-NO.: 2D-Y-009087; MTR-CODE: BBE;BBF; MOD: LT28; 1. ALT; 2 ALT **6 PK 1718**  
 ALT FROM CHA-NO.: 2D-Y-009087; MTR-CODE: BBE;BBF; MOD: LT32; 1. ALT; 2 ALT **6 PK 1718**  
 ALT FROM CHA-NO.: 2D-Y-009087; MTR-CODE: BBE;BBF; MOD: LT35; 1. ALT; 2 ALT **6 PK 1718**

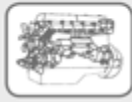
**VW**
**LT 28-46 II Kasten (2DX0AE)**

<b>2.5 TDI</b>						
2461 ccm	61 kW	BBE	05.01 - 07.06	ALT	FROM CHA-NO.: 2D-Y-009087; MTR-CODE: BBE;BBF; MOD: LT46; 1. ALT; 2 ALT	<b>6 PK 1718</b>
				ALT	MTR-CODE: BBE;BBF; MOD: LT28; + AC	<b>6 PK 2145</b>
				ALT	MTR-CODE: BBE;BBF; MOD: LT28; 2. ALT; 2 ALT	<b>6 PK 2080</b>
				ALT	MTR-CODE: BBE;BBF; MOD: LT32; + AC	<b>6 PK 2145</b>
				ALT	MTR-CODE: BBE;BBF; MOD: LT32; 2. ALT; 2 ALT	<b>6 PK 2080</b>
				ALT	MTR-CODE: BBE;BBF; MOD: LT35; + AC	<b>6 PK 2145</b>
				ALT	MTR-CODE: BBE;BBF; MOD: LT35; 2. ALT; 2 ALT	<b>6 PK 2080</b>
				ALT	MTR-CODE: BBE;BBF; MOD: LT46; + AC	<b>6 PK 2145</b>
				ALT	MTR-CODE: BBE;BBF; MOD: LT46; 2. ALT; 2 ALT	<b>6 PK 2080</b>
				ALT	UNTIL CHA-NO.: 2D-Y-009086; MTR-CODE: BBE;BBF; MOD: LT28; 1. ALT; 2 ALT	<b>6 PK 1751</b>
				ALT	UNTIL CHA-NO.: 2D-Y-009086; MTR-CODE: BBE;BBF; MOD: LT32; 1. ALT; 2 ALT	<b>6 PK 1751</b>
				ALT	UNTIL CHA-NO.: 2D-Y-009086; MTR-CODE: BBE;BBF; MOD: LT35; 1. ALT; 2 ALT	<b>6 PK 1751</b>
				ALT	UNTIL CHA-NO.: 2D-Y-009086; MTR-CODE: BBE;BBF; MOD: LT46; 1. ALT; 2 ALT	<b>6 PK 1751</b>
				CAM		<b>ZRK 1301</b>
				INJ-P		<b>ZRK 1238</b>
				CAM		<b>KT 1214</b>
				CAM		<b>KT 1302</b>
				CAM	UNTIL: 04.06	<b>KT 1442</b>
				W-P; CAM	UNTIL CHA-NO.: 2D-6-020000	<b>KT 1214 W1</b>

<b>2.5 TDI</b>						
2461 ccm	66 kW	APA	05.99 - 07.06	ALT	FROM CHA-NO.: 2D-Y-009087; MTR-CODE: AHD;ANJ;APA;AVR; MOD: LT28; - AC	<b>6 PK 1718</b>
				ALT	FROM CHA-NO.: 2D-Y-009087; MTR-CODE: AHD;ANJ;APA;AVR; MOD: LT35; - AC	<b>6 PK 1718</b>
				ALT	FROM CHA-NO.: 2D-Y-009087; MTR-CODE: AHD;ANJ;APA;AVR; MOD: LT46; - AC	<b>6 PK 1718</b>
				ALT	FROM CHA-NO.: 2D-Y-009207; MTR-CODE: AHD;ANJ;APA;AVR; MOD: LT28; + AC	<b>6 PK 2145</b>
				ALT	FROM CHA-NO.: 2D-Y-009207; MTR-CODE: AHD;ANJ;APA;AVR; MOD: LT35; + AC; - MTR-CODE: AHD	<b>6 PK 2145</b>
				ALT	FROM CHA-NO.: 2D-Y-009207; MTR-CODE: AHD;ANJ;APA;AVR; MOD: LT46; + AC; - MTR-CODE: AHD	<b>6 PK 2145</b>
				ALT	MTR-CODE: AHD;ANJ;APA;AVR; OE-NO.: 074903137AR; MOD: LT28; 2. ALT; 2 ALT	<b>6 PK 2100</b>
				ALT	MTR-CODE: AHD;ANJ;APA;AVR; OE-NO.: 074903137AR; MOD: LT35; 2. ALT; 2 ALT	<b>6 PK 2100</b>
				ALT	MTR-CODE: AHD;ANJ;APA;AVR; OE-NO.: 074903137AR; MOD: LT46; 2. ALT; 2 ALT	<b>6 PK 2100</b>
				ALT	MTR-CODE: AHD;ANJ;APA;AVR; OE-NO.: 074903137BC; MOD: LT28; 2. ALT; 2 ALT	<b>6 PK 2115</b>
				ALT	MTR-CODE: AHD;ANJ;APA;AVR; OE-NO.: 074903137BC; MOD: LT35; 2. ALT; 2 ALT	<b>6 PK 2115</b>
				ALT	MTR-CODE: AHD;ANJ;APA;AVR; OE-NO.: 074903137BC; MOD: LT46; 2. ALT; 2 ALT	<b>6 PK 2115</b>
				ALT	UNTIL CHA-NO.: 2D-Y-009086; MTR-CODE: AHD;ANJ;APA;AVR; MOD: LT28; - AC	<b>6 PK 1751</b>
				ALT	UNTIL CHA-NO.: 2D-Y-009086; MTR-CODE: AHD;ANJ;APA;AVR; MOD: LT35; - AC	<b>6 PK 1751</b>
				ALT	UNTIL CHA-NO.: 2D-Y-009086; MTR-CODE: AHD;ANJ;APA;AVR; MOD: LT46; - AC	<b>6 PK 1751</b>
				ALT	UNTIL CHA-NO.: 2D-Y-009206; MTR-CODE: AHD;ANJ;APA;AVR; MOD: LT28; + AC	<b>6 PK 2170</b>
				ALT	UNTIL CHA-NO.: 2D-Y-009206; MTR-CODE: AHD;ANJ;APA;AVR; MOD: LT35; + AC	<b>6 PK 2170</b>
				ALT	UNTIL CHA-NO.: 2D-Y-009206; MTR-CODE: AHD;ANJ;APA;AVR; MOD: LT46; + AC	<b>6 PK 2170</b>
				CAM		<b>ZRK 1301</b>
				INJ-P		<b>ZRK 1238</b>
				CAM		<b>KT 1214</b>
				CAM		<b>KT 1302</b>
				CAM	UNTIL: 04.01	<b>KT 1442</b>
				W-P; CAM		<b>KT 1214 W1</b>

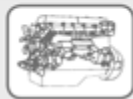

## VW

### LT 28-46 II Kasten (2DX0AE)

#### 2.5 TDI

2461 ccm	70 kW	BBF	05.01 - 07.06	ALT	FROM CHA-NO.: 2D-Y-009087; MTR-CODE: BBE;BBF; MOD: LT28; 1. ALT; 2 ALT	<b>6 PK 1718</b>
				ALT	FROM CHA-NO.: 2D-Y-009087; MTR-CODE: BBE;BBF; MOD: LT32; 1. ALT; 2 ALT	<b>6 PK 1718</b>
				ALT	FROM CHA-NO.: 2D-Y-009087; MTR-CODE: BBE;BBF; MOD: LT35; 1. ALT; 2 ALT	<b>6 PK 1718</b>
				ALT	FROM CHA-NO.: 2D-Y-009087; MTR-CODE: BBE;BBF; MOD: LT46; 1. ALT; 2 ALT	<b>6 PK 1718</b>
				ALT	MTR-CODE: BBE;BBF; MOD: LT28; + AC	<b>6 PK 2145</b>
				ALT	MTR-CODE: BBE;BBF; MOD: LT28; 2. ALT; 2 ALT	<b>6 PK 2080</b>
				ALT	MTR-CODE: BBE;BBF; MOD: LT32; + AC	<b>6 PK 2145</b>
				ALT	MTR-CODE: BBE;BBF; MOD: LT32; 2. ALT; 2 ALT	<b>6 PK 2080</b>
				ALT	MTR-CODE: BBE;BBF; MOD: LT35; + AC	<b>6 PK 2145</b>
				ALT	MTR-CODE: BBE;BBF; MOD: LT35; 2. ALT; 2 ALT	<b>6 PK 2080</b>
				ALT	MTR-CODE: BBE;BBF; MOD: LT46; + AC	<b>6 PK 2145</b>
				ALT	MTR-CODE: BBE;BBF; MOD: LT46; 2. ALT; 2 ALT	<b>6 PK 2080</b>
				ALT	UNTIL CHA-NO.: 2D-Y-009086; MTR-CODE: BBE;BBF; MOD: LT28; 1. ALT; 2 ALT	<b>6 PK 1751</b>
				ALT	UNTIL CHA-NO.: 2D-Y-009086; MTR-CODE: BBE;BBF; MOD: LT32; 1. ALT; 2 ALT	<b>6 PK 1751</b>
				ALT	UNTIL CHA-NO.: 2D-Y-009086; MTR-CODE: BBE;BBF; MOD: LT35; 1. ALT; 2 ALT	<b>6 PK 1751</b>
				ALT	UNTIL CHA-NO.: 2D-Y-009086; MTR-CODE: BBE;BBF; MOD: LT46; 1. ALT; 2 ALT	<b>6 PK 1751</b>
				CAM		<b>ZRK 1301</b>
				INJ-P		<b>ZRK 1238</b>
				CAM		<b>KT 1214</b>
				CAM		<b>KT 1302</b>
				CAM	UNTIL: 04.06	<b>KT 1442</b>
				W-P; CAM	UNTIL CHA-NO.: 2D-6-020000	<b>KT 1214 W1</b>

#### 2.5 TDI

2461 ccm	75 kW	AHD	05.96 - 08.99	ALT	FROM CHA-NO.: 2D-Y-009087; MTR-CODE: AHD;ANJ;APA;AVR; MOD: LT28; - AC	<b>6 PK 1718</b>
				ALT	FROM CHA-NO.: 2D-Y-009087; MTR-CODE: AHD;ANJ;APA;AVR; MOD: LT35; - AC	<b>6 PK 1718</b>
				ALT	FROM CHA-NO.: 2D-Y-009207; MTR-CODE: AHD;ANJ;APA;AVR; MOD: LT28; + AC	<b>6 PK 2145</b>
				ALT	FROM CHA-NO.: 2D-Y-009207; MTR-CODE: AHD;ANJ;APA;AVR; MOD: LT35; + AC; - MTR-CODE: AHD	<b>6 PK 2145</b>
				ALT	FROM: 12.96; FROM CHA-NO.: 2D-Y-009087; MTR-CODE: AHD;ANJ;APA;AVR; MOD: LT46; - AC	<b>6 PK 1718</b>
				ALT	FROM: 12.96; FROM CHA-NO.: 2D-Y-009207; MTR-CODE: AHD;ANJ;APA;AVR; MOD: LT46; + AC; - MTR-CODE: AHD	<b>6 PK 2145</b>
				ALT	FROM: 12.96; MTR-CODE: AHD;ANJ;APA;AVR; OE-NO.: 074903137AR; MOD: LT46; 2. ALT; 2 ALT	<b>6 PK 2100</b>
				ALT	FROM: 12.96; MTR-CODE: AHD;ANJ;APA;AVR; OE-NO.: 074903137BC; MOD: LT46; 2. ALT; 2 ALT	<b>6 PK 2115</b>
				ALT	FROM: 12.96; UNTIL CHA-NO.: 2D-Y-009086; MTR-CODE: AHD;ANJ;APA;AVR; MOD: LT46; - AC	<b>6 PK 1751</b>
				ALT	FROM: 12.96; UNTIL CHA-NO.: 2D-Y-009206; MTR-CODE: AHD;ANJ;APA;AVR; MOD: LT46; + AC	<b>6 PK 2170</b>
				ALT	MTR-CODE: AHD;ANJ;APA;AVR; OE-NO.: 074903137AR; MOD: LT28; 2. ALT; 2 ALT	<b>6 PK 2100</b>
				ALT	MTR-CODE: AHD;ANJ;APA;AVR; OE-NO.: 074903137AR; MOD: LT35; 2. ALT; 2 ALT	<b>6 PK 2100</b>
				ALT	MTR-CODE: AHD;ANJ;APA;AVR; OE-NO.: 074903137BC; MOD: LT28; 2. ALT; 2 ALT	<b>6 PK 2115</b>
				ALT	MTR-CODE: AHD;ANJ;APA;AVR; OE-NO.: 074903137BC; MOD: LT35; 2. ALT; 2 ALT	<b>6 PK 2115</b>
				ALT	UNTIL CHA-NO.: 2D-Y-009086; MTR-CODE: AHD;ANJ;APA;AVR; MOD: LT28; - AC	<b>6 PK 1751</b>
				ALT	UNTIL CHA-NO.: 2D-Y-009086; MTR-CODE: AHD;ANJ;APA;AVR; MOD: LT35; - AC	<b>6 PK 1751</b>

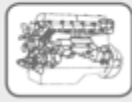
**VW**
**LT 28-46 II Kasten (2DX0AE)**

2.5 TDI						
2461 ccm	75 kW	AHD	05.96 - 08.99	ALT	UNTIL CHA-NO.: 2D-Y-009206; MTR-CODE: AHD;ANJ;APA;AVR; MOD: LT28; + AC	<b>6 PK 2170</b>
				ALT	UNTIL CHA-NO.: 2D-Y-009206; MTR-CODE: AHD;ANJ;APA;AVR; MOD: LT35; + AC	<b>6 PK 2170</b>
				CAM		<b>ZRK 1301</b>
				INJ-P		<b>ZRK 1238</b>
				CAM		<b>KT 1214</b>
				CAM		<b>KT 1302</b>
				CAM	UNTIL: 05.99	<b>KT 1442</b>
				W-P; CAM		<b>KT 1214 W1</b>

2.5 TDI						
2461 ccm	80 kW	ANJ;AVR	05.99 - 07.06	ALT	FROM CHA-NO.: 2D-Y-009087; MTR-CODE: AHD;ANJ;APA;AVR; MOD: LT28; - AC	<b>6 PK 1718</b>
				ALT	FROM CHA-NO.: 2D-Y-009087; MTR-CODE: AHD;ANJ;APA;AVR; MOD: LT35; - AC	<b>6 PK 1718</b>
				ALT	FROM CHA-NO.: 2D-Y-009087; MTR-CODE: AHD;ANJ;APA;AVR; MOD: LT46; - AC	<b>6 PK 1718</b>
				ALT	FROM CHA-NO.: 2D-Y-009207; MTR-CODE: AHD;ANJ;APA;AVR; MOD: LT28; + AC	<b>6 PK 2145</b>
				ALT	FROM CHA-NO.: 2D-Y-009207; MTR-CODE: AHD;ANJ;APA;AVR; MOD: LT35; + AC; - MTR-CODE: AHD	<b>6 PK 2145</b>
				ALT	FROM CHA-NO.: 2D-Y-009207; MTR-CODE: AHD;ANJ;APA;AVR; MOD: LT46; + AC; - MTR-CODE: AHD	<b>6 PK 2145</b>
				ALT	FROM: 05.01; FROM CHA-NO.: 2D-Y-009087; MTR-CODE: ANJ;AVR; MOD: LT32; - AC	<b>6 PK 1718</b>
				ALT	FROM: 05.01; MTR-CODE: ANJ;AVR; MOD: LT32; + AC	<b>6 PK 2145</b>
				ALT	FROM: 05.01; MTR-CODE: ANJ;AVR; OE-NO.: 074903137AR; MOD: LT32; 2. ALT; 2 ALT	<b>6 PK 2100</b>
				ALT	FROM: 05.01; MTR-CODE: ANJ;AVR; OE-NO.: 074903137BC; MOD: LT32; 2. ALT; 2 ALT	<b>6 PK 2115</b>
				ALT	FROM: 05.01; UNTIL CHA-NO.: 2D-Y-009086; MTR-CODE: ANJ;AVR; MOD: LT32; - AC	<b>6 PK 1751</b>
				ALT	MTR-CODE: AHD;ANJ;APA;AVR; OE-NO.: 074903137AR; MOD: LT28; 2. ALT; 2 ALT	<b>6 PK 2100</b>
				ALT	MTR-CODE: AHD;ANJ;APA;AVR; OE-NO.: 074903137AR; MOD: LT35; 2. ALT; 2 ALT	<b>6 PK 2100</b>
				ALT	MTR-CODE: AHD;ANJ;APA;AVR; OE-NO.: 074903137AR; MOD: LT46; 2. ALT; 2 ALT	<b>6 PK 2100</b>
				ALT	MTR-CODE: AHD;ANJ;APA;AVR; OE-NO.: 074903137BC; MOD: LT28; 2. ALT; 2 ALT	<b>6 PK 2115</b>
				ALT	MTR-CODE: AHD;ANJ;APA;AVR; OE-NO.: 074903137BC; MOD: LT35; 2. ALT; 2 ALT	<b>6 PK 2115</b>
				ALT	MTR-CODE: AHD;ANJ;APA;AVR; OE-NO.: 074903137BC; MOD: LT46; 2. ALT; 2 ALT	<b>6 PK 2115</b>
				ALT	UNTIL CHA-NO.: 2D-Y-009086; MTR-CODE: AHD;ANJ;APA;AVR; MOD: LT28; - AC	<b>6 PK 1751</b>
				ALT	UNTIL CHA-NO.: 2D-Y-009086; MTR-CODE: AHD;ANJ;APA;AVR; MOD: LT35; - AC	<b>6 PK 1751</b>
				ALT	UNTIL CHA-NO.: 2D-Y-009086; MTR-CODE: AHD;ANJ;APA;AVR; MOD: LT46; - AC	<b>6 PK 1751</b>
				ALT	UNTIL CHA-NO.: 2D-Y-009206; MTR-CODE: AHD;ANJ;APA;AVR; MOD: LT28; + AC	<b>6 PK 2170</b>
				ALT	UNTIL CHA-NO.: 2D-Y-009206; MTR-CODE: AHD;ANJ;APA;AVR; MOD: LT35; + AC	<b>6 PK 2170</b>
				ALT	UNTIL CHA-NO.: 2D-Y-009206; MTR-CODE: AHD;ANJ;APA;AVR; MOD: LT46; + AC	<b>6 PK 2170</b>
				CAM		<b>ZRK 1301</b>
				INJ-P		<b>ZRK 1238</b>
				CAM		<b>KT 1214</b>
				CAM		<b>KT 1302</b>
				CAM	UNTIL: 04.06	<b>KT 1442</b>
				W-P; CAM		<b>KT 1214 W1</b>

2.8 TDI						
2799 ccm	92 kW	AGK	06.97 - 12.98	PS		<b>AVX 10 x 900</b>
				ALT	MTR-CODE: AGK;ATA; MOD: LT28; - AC	<b>6 PK 1642</b>
				ALT	MTR-CODE: AGK;ATA; MOD: LT28; + AC	<b>6 PK 2130</b>
				ALT	MTR-CODE: AGK;ATA; MOD: LT28; 2. ALT; 2 ALT	<b>6 PK 2000</b>
				ALT	MTR-CODE: AGK;ATA; MOD: LT35; - AC	<b>6 PK 1642</b>





## VW

### LT 28-46 II Kasten (2DX0AE)

#### 2.8 TDI

2799 ccm	92 kW	AGK	06.97 - 12.98	ALT	MTR-CODE: AGK;ATA; MOD: LT35; + AC	6 PK 2130
				ALT	MTR-CODE: AGK;ATA; MOD: LT35; 2. ALT; 2 ALT	6 PK 2000
				ALT	MTR-CODE: AGK;ATA; MOD: LT46; - AC	6 PK 1642
				ALT	MTR-CODE: AGK;ATA; MOD: LT46; + AC	6 PK 2130
				ALT	MTR-CODE: AGK;ATA; MOD: LT46; 2. ALT; 2 ALT	6 PK 2000

#### 2.8 TDI

2799 ccm	96 kW	ATA	01.99 - 07.06	ALT	MTR-CODE: AGK;ATA; MOD: LT28; - AC	6 PK 1642
				ALT	MTR-CODE: AGK;ATA; MOD: LT28; + AC	6 PK 2130
				ALT	MTR-CODE: AGK;ATA; MOD: LT28; 2. ALT; 2 ALT	6 PK 2000
				ALT	MTR-CODE: AGK;ATA; MOD: LT35; - AC	6 PK 1642
				ALT	MTR-CODE: AGK;ATA; MOD: LT35; + AC	6 PK 2130
				ALT	MTR-CODE: AGK;ATA; MOD: LT35; 2. ALT; 2 ALT	6 PK 2000
				ALT	MTR-CODE: AGK;ATA; MOD: LT46; - AC	6 PK 1642
				ALT	MTR-CODE: AGK;ATA; MOD: LT46; + AC	6 PK 2130
				ALT	MTR-CODE: AGK;ATA; MOD: LT46; 2. ALT; 2 ALT	6 PK 2000

#### 2.8 TDI

2799 ccm	116 kW	AUH;BCQ	04.02 - 07.06	ALT	FROM: 06.03; MTR-CODE: BCQ; MOD: LT32; - AC	6 PK 1685
				ALT	FROM: 06.03; MTR-CODE: BCQ; MOD: LT32; + AC	6 PK 2155
				ALT	MTR-CODE: AUH;BCQ; MOD: LT28; - AC	6 PK 1685
				ALT	MTR-CODE: AUH;BCQ; MOD: LT28; + AC	6 PK 2155
				ALT	MTR-CODE: AUH;BCQ; MOD: LT35; - AC	6 PK 1685
				ALT	MTR-CODE: AUH;BCQ; MOD: LT35; + AC	6 PK 2155
				ALT	MTR-CODE: AUH;BCQ; MOD: LT46; - AC	6 PK 1685
				ALT	MTR-CODE: AUH;BCQ; MOD: LT46; + AC	6 PK 2155

### LT 28-46 II Pritsche/Fahrgestell (2DX0FE)

#### 2.3

2295 ccm	105 kW	AGL	06.96 - 07.06	ALT	FROM: 12.96; OE-NO.: 00A260849; MOD: LT46; + AC	6 PK 2205
				ALT	FROM: 12.96; OE-NO.: 00A903137; MOD: LT46; - AC	6 PK 2100
				ALT	FROM: 12.96; OE-NO.: 2D0145933A; MOD: LT46; - AC	6 PK 2115
				ALT	FROM: 12.96; OE-NO.: 2D0260849; MOD: LT46; + AC	6 PK 2215
				ALT	OE-NO.: 00A260849; MOD: LT28; + AC	6 PK 2205
				ALT	OE-NO.: 00A260849; MOD: LT35; + AC	6 PK 2205
				ALT	OE-NO.: 00A903137; MOD: LT28; - AC	6 PK 2100
				ALT	OE-NO.: 00A903137; MOD: LT35; - AC	6 PK 2100
				ALT	OE-NO.: 2D0145933A; MOD: LT28; - AC	6 PK 2115
				ALT	OE-NO.: 2D0145933A; MOD: LT35; - AC	6 PK 2115
				ALT	OE-NO.: 2D0260849; MOD: LT28; + AC	6 PK 2215
				ALT	OE-NO.: 2D0260849; MOD: LT35; + AC	6 PK 2215

#### 2.5 SDI

2461 ccm	55 kW	AGX	09.96 - 07.06	ALT	FROM CHA-NO.: 2D-Y-009087; MOD: LT28; - AC	6 PK 1718
				ALT	FROM CHA-NO.: 2D-Y-009087; MOD: LT35; - AC	6 PK 1718
				ALT	FROM CHA-NO.: 2D-Y-009207; MOD: LT28; + AC	6 PK 2145
				ALT	FROM CHA-NO.: 2D-Y-009207; MOD: LT35; + AC	6 PK 2145
				ALT	OE-NO.: 074903137AR; MOD: LT28; 2. ALT; 2 ALT	6 PK 2100
				ALT	OE-NO.: 074903137AR; MOD: LT35; 2. ALT; 2 ALT	6 PK 2100
				ALT	OE-NO.: 074903137BC; MOD: LT28; 2. ALT; 2 ALT	6 PK 2115
				ALT	OE-NO.: 074903137BC; MOD: LT35; 2. ALT; 2 ALT	6 PK 2115
				ALT	UNTIL CHA-NO.: 2D-Y-009086; MOD: LT28; - AC	6 PK 1751
				ALT	UNTIL CHA-NO.: 2D-Y-009086; MOD: LT35; - AC	6 PK 1751

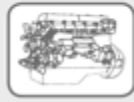

## VW

### LT 28-46 II Pritsche/Fahrgestell (2DX0FE)

#### 2.5 SDI

2461 ccm	55 kW	AGX	09.96 - 07.06	ALT	UNTIL CHA-NO.: 2D-Y-009206; MOD: LT28; + AC	6 PK 2170
				ALT	UNTIL CHA-NO.: 2D-Y-009206; MOD: LT35; + AC	6 PK 2170
				CAM		ZRK 1301
				INJ-P		ZRK 1238
				CAM		KT 1218
				CAM		KT 1302
				CAM		KT 1515
				W-P; CAM		KT 1218 W1

#### 2.5 TDI

2461 ccm	61 kW	BBE	05.01 - 07.06	ALT	FROM CHA-NO.: 2D-Y-009087; MTR-CODE: BBE;BBF; MOD: LT28; 1. ALT; 2 ALT	6 PK 1718
				ALT	FROM CHA-NO.: 2D-Y-009087; MTR-CODE: BBE;BBF; MOD: LT35; 1. ALT; 2 ALT	6 PK 1718
				ALT	FROM CHA-NO.: 2D-Y-009087; MTR-CODE: BBE;BBF; MOD: LT46; 1. ALT; 2 ALT	6 PK 1718
				ALT	MTR-CODE: BBE;BBF; MOD: LT28; + AC	6 PK 2145
				ALT	MTR-CODE: BBE;BBF; MOD: LT28; 2. ALT; 2 ALT	6 PK 2080
				ALT	MTR-CODE: BBE;BBF; MOD: LT35; + AC	6 PK 2145
				ALT	MTR-CODE: BBE;BBF; MOD: LT35; 2. ALT; 2 ALT	6 PK 2080
				ALT	MTR-CODE: BBE;BBF; MOD: LT46; + AC	6 PK 2145
				ALT	MTR-CODE: BBE;BBF; MOD: LT46; 2. ALT; 2 ALT	6 PK 2080
				ALT	UNTIL CHA-NO.: 2D-Y-009086; MTR-CODE: BBE;BBF; MOD: LT28; 1. ALT; 2 ALT	6 PK 1751
				ALT	UNTIL CHA-NO.: 2D-Y-009086; MTR-CODE: BBE;BBF; MOD: LT35; 1. ALT; 2 ALT	6 PK 1751
				ALT	UNTIL CHA-NO.: 2D-Y-009086; MTR-CODE: BBE;BBF; MOD: LT46; 1. ALT; 2 ALT	6 PK 1751
				CAM		ZRK 1301
				INJ-P		ZRK 1238
				CAM		KT 1214
				CAM		KT 1302
				CAM	UNTIL: 04.06	KT 1442
				W-P; CAM		KT 1214 W1

#### 2.5 TDI

2461 ccm	66 kW	APA	05.99 - 07.06	ALT	FROM CHA-NO.: 2D-Y-009087; MTR-CODE: AHD;ANJ;APA;AVR; MOD: LT28; - AC	6 PK 1718
				ALT	FROM CHA-NO.: 2D-Y-009087; MTR-CODE: AHD;ANJ;APA;AVR; MOD: LT35; - AC	6 PK 1718
				ALT	FROM CHA-NO.: 2D-Y-009087; MTR-CODE: AHD;ANJ;APA;AVR; MOD: LT46; - AC	6 PK 1718
				ALT	FROM CHA-NO.: 2D-Y-009207; MTR-CODE: AHD;ANJ;APA;AVR; MOD: LT28; + AC	6 PK 2145
				ALT	FROM CHA-NO.: 2D-Y-009207; MTR-CODE: AHD;ANJ;APA;AVR; MOD: LT35; + AC; - MTR-CODE: AHD	6 PK 2145
				ALT	FROM CHA-NO.: 2D-Y-009207; MTR-CODE: AHD;ANJ;APA;AVR; MOD: LT46; + AC; - MTR-CODE: AHD	6 PK 2145
				ALT	MTR-CODE: AHD;ANJ;APA;AVR; OE-NO.: 074903137AR; MOD: LT28; 2. ALT; 2 ALT	6 PK 2100
				ALT	MTR-CODE: AHD;ANJ;APA;AVR; OE-NO.: 074903137AR; MOD: LT35; 2. ALT; 2 ALT	6 PK 2100
				ALT	MTR-CODE: AHD;ANJ;APA;AVR; OE-NO.: 074903137AR; MOD: LT46; 2. ALT; 2 ALT	6 PK 2100
				ALT	MTR-CODE: AHD;ANJ;APA;AVR; OE-NO.: 074903137BC; MOD: LT28; 2. ALT; 2 ALT	6 PK 2115
				ALT	MTR-CODE: AHD;ANJ;APA;AVR; OE-NO.: 074903137BC; MOD: LT35; 2. ALT; 2 ALT	6 PK 2115
				ALT	MTR-CODE: AHD;ANJ;APA;AVR; OE-NO.: 074903137BC; MOD: LT46; 2. ALT; 2 ALT	6 PK 2115
				ALT	UNTIL CHA-NO.: 2D-Y-009086; MTR-CODE: AHD;ANJ;APA;AVR; MOD: LT28; - AC	6 PK 1751
				ALT	UNTIL CHA-NO.: 2D-Y-009086; MTR-CODE: AHD;ANJ;APA;AVR; MOD: LT35; - AC	6 PK 1751
				ALT	UNTIL CHA-NO.: 2D-Y-009086; MTR-CODE: AHD;ANJ;APA;AVR; MOD: LT46; - AC	6 PK 1751



## VW

### LT 28-46 II Pritsche/Fahrgestell (2DX0FE)

#### 2.5 TDI

2461 ccm	66 kW	APA	05.99 - 07.06	ALT	UNTIL CHA-NO.: 2D-Y-009206; MTR-CODE: AHD;ANJ;APA;AVR; MOD: LT28; + AC	6 PK 2170
				ALT	UNTIL CHA-NO.: 2D-Y-009206; MTR-CODE: AHD;ANJ;APA;AVR; MOD: LT35; + AC	6 PK 2170
				ALT	UNTIL CHA-NO.: 2D-Y-009206; MTR-CODE: AHD;ANJ;APA;AVR; MOD: LT46; + AC	6 PK 2170
				CAM		ZRK 1301
				INJ-P		ZRK 1238
				CAM		KT 1214
				CAM		KT 1302
				CAM	UNTIL: 04.01	KT 1442
				W-P; CAM		KT 1214 W1

#### 2.5 TDI

2461 ccm	70 kW	BBF	05.01 - 07.06	ALT	FROM CHA-NO.: 2D-Y-009087; MTR-CODE: BBE;BBF; MOD: LT28; 1. ALT; 2 ALT	6 PK 1718
				ALT	FROM CHA-NO.: 2D-Y-009087; MTR-CODE: BBE;BBF; MOD: LT35; 1. ALT; 2 ALT	6 PK 1718
				ALT	FROM CHA-NO.: 2D-Y-009087; MTR-CODE: BBE;BBF; MOD: LT46; 1. ALT; 2 ALT	6 PK 1718
				ALT	MTR-CODE: BBE;BBF; MOD: LT28; + AC	6 PK 2145
				ALT	MTR-CODE: BBE;BBF; MOD: LT28; 2. ALT; 2 ALT	6 PK 2080
				ALT	MTR-CODE: BBE;BBF; MOD: LT35; + AC	6 PK 2145
				ALT	MTR-CODE: BBE;BBF; MOD: LT35; 2. ALT; 2 ALT	6 PK 2080
				ALT	MTR-CODE: BBE;BBF; MOD: LT46; + AC	6 PK 2145
				ALT	MTR-CODE: BBE;BBF; MOD: LT46; 2. ALT; 2 ALT	6 PK 2080
				ALT	UNTIL CHA-NO.: 2D-Y-009086; MTR-CODE: BBE;BBF; MOD: LT28; 1. ALT; 2 ALT	6 PK 1751
				ALT	UNTIL CHA-NO.: 2D-Y-009086; MTR-CODE: BBE;BBF; MOD: LT35; 1. ALT; 2 ALT	6 PK 1751
				ALT	UNTIL CHA-NO.: 2D-Y-009086; MTR-CODE: BBE;BBF; MOD: LT46; 1. ALT; 2 ALT	6 PK 1751
				CAM		ZRK 1301
				INJ-P		ZRK 1238
				CAM		KT 1214
				CAM		KT 1302
				CAM	UNTIL: 04.06	KT 1442
				W-P; CAM	UNTIL CHA-NO.: 2D-6-020000	KT 1214 W1

#### 2.5 TDI

2461 ccm	75 kW	AHD	06.96 - 08.99	ALT	FROM CHA-NO.: 2D-Y-009087; MTR-CODE: AHD;ANJ;APA;AVR; MOD: LT28; - AC	6 PK 1718
				ALT	FROM CHA-NO.: 2D-Y-009087; MTR-CODE: AHD;ANJ;APA;AVR; MOD: LT35; - AC	6 PK 1718
				ALT	FROM CHA-NO.: 2D-Y-009207; MTR-CODE: AHD;ANJ;APA;AVR; MOD: LT28; + AC	6 PK 2145
				ALT	FROM CHA-NO.: 2D-Y-009207; MTR-CODE: AHD;ANJ;APA;AVR; MOD: LT35; + AC; - MTR-CODE: AHD	6 PK 2145
				ALT	FROM: 12.96; FROM CHA-NO.: 2D-Y-009087; MTR-CODE: AHD;ANJ;APA;AVR; MOD: LT46; - AC	6 PK 1718
				ALT	FROM: 12.96; FROM CHA-NO.: 2D-Y-009207; MTR-CODE: AHD;ANJ;APA;AVR; MOD: LT46; + AC; - MTR-CODE: AHD	6 PK 2145
				ALT	FROM: 12.96; MTR-CODE: AHD;ANJ;APA;AVR; OE-NO.: 074903137AR; MOD: LT46; 2. ALT; 2 ALT	6 PK 2100
				ALT	FROM: 12.96; MTR-CODE: AHD;ANJ;APA;AVR; OE-NO.: 074903137BC; MOD: LT46; 2. ALT; 2 ALT	6 PK 2115
				ALT	FROM: 12.96; UNTIL CHA-NO.: 2D-Y-009086; MTR-CODE: AHD;ANJ;APA;AVR; MOD: LT46; - AC	6 PK 1751
				ALT	FROM: 12.96; UNTIL CHA-NO.: 2D-Y-009206; MTR-CODE: AHD;ANJ;APA;AVR; MOD: LT46; + AC	6 PK 2170
				ALT	MTR-CODE: AHD;ANJ;APA;AVR; OE-NO.: 074903137AR; MOD: LT28; 2. ALT; 2 ALT	6 PK 2100
				ALT	MTR-CODE: AHD;ANJ;APA;AVR; OE-NO.: 074903137AR; MOD: LT35; 2. ALT; 2 ALT	6 PK 2100

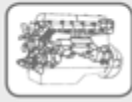

## VW

### LT 28-46 II Pritsche/Fahrgestell (2DX0FE)

#### 2.5 TDI

2461 ccm	75 kW	AHD	06.96 - 08.99	ALT	MTR-CODE: AHD;ANJ;APA;AVR; OE-NO.: 074903137BC; MOD: LT28; 2. ALT; 2 ALT	6 PK 2115
				ALT	MTR-CODE: AHD;ANJ;APA;AVR; OE-NO.: 074903137BC; MOD: LT35; 2. ALT; 2 ALT	6 PK 2115
				ALT	UNTIL CHA-NO.: 2D-Y-009086; MTR-CODE: AHD;ANJ;APA;AVR; MOD: LT28; - AC	6 PK 1751
				ALT	UNTIL CHA-NO.: 2D-Y-009086; MTR-CODE: AHD;ANJ;APA;AVR; MOD: LT35; - AC	6 PK 1751
				ALT	UNTIL CHA-NO.: 2D-Y-009206; MTR-CODE: AHD;ANJ;APA;AVR; MOD: LT28; + AC	6 PK 2170
				ALT	UNTIL CHA-NO.: 2D-Y-009206; MTR-CODE: AHD;ANJ;APA;AVR; MOD: LT35; + AC	6 PK 2170
				CAM		ZRK 1301
				INJ-P		ZRK 1238
				CAM		KT 1214
				CAM		KT 1302
				CAM	UNTIL: 05.99	KT 1442
				W-P; CAM		KT 1214 W1

#### 2.5 TDI

2461 ccm	80 kW	ANJ;AVR	05.99 - 07.06	ALT	FROM CHA-NO.: 2D-Y-009087; MTR-CODE: AHD;ANJ;APA;AVR; MOD: LT28; - AC	6 PK 1718
				ALT	FROM CHA-NO.: 2D-Y-009087; MTR-CODE: AHD;ANJ;APA;AVR; MOD: LT35; - AC	6 PK 1718
				ALT	FROM CHA-NO.: 2D-Y-009087; MTR-CODE: AHD;ANJ;APA;AVR; MOD: LT46; - AC	6 PK 1718
				ALT	FROM CHA-NO.: 2D-Y-009207; MTR-CODE: AHD;ANJ;APA;AVR; MOD: LT28; + AC	6 PK 2145
				ALT	FROM CHA-NO.: 2D-Y-009207; MTR-CODE: AHD;ANJ;APA;AVR; MOD: LT35; + AC; - MTR-CODE: AHD	6 PK 2145
				ALT	FROM CHA-NO.: 2D-Y-009207; MTR-CODE: AHD;ANJ;APA;AVR; MOD: LT46; + AC; - MTR-CODE: AHD	6 PK 2145
				ALT	MTR-CODE: AHD;ANJ;APA;AVR; OE-NO.: 074903137AR; MOD: LT28; 2. ALT; 2 ALT	6 PK 2100
				ALT	MTR-CODE: AHD;ANJ;APA;AVR; OE-NO.: 074903137AR; MOD: LT35; 2. ALT; 2 ALT	6 PK 2100
				ALT	MTR-CODE: AHD;ANJ;APA;AVR; OE-NO.: 074903137AR; MOD: LT46; 2. ALT; 2 ALT	6 PK 2100
				ALT	MTR-CODE: AHD;ANJ;APA;AVR; OE-NO.: 074903137BC; MOD: LT28; 2. ALT; 2 ALT	6 PK 2115
				ALT	MTR-CODE: AHD;ANJ;APA;AVR; OE-NO.: 074903137BC; MOD: LT35; 2. ALT; 2 ALT	6 PK 2115
				ALT	MTR-CODE: AHD;ANJ;APA;AVR; OE-NO.: 074903137BC; MOD: LT46; 2. ALT; 2 ALT	6 PK 2115
				ALT	UNTIL CHA-NO.: 2D-Y-009086; MTR-CODE: AHD;ANJ;APA;AVR; MOD: LT28; - AC	6 PK 1751
				ALT	UNTIL CHA-NO.: 2D-Y-009086; MTR-CODE: AHD;ANJ;APA;AVR; MOD: LT35; - AC	6 PK 1751
				ALT	UNTIL CHA-NO.: 2D-Y-009086; MTR-CODE: AHD;ANJ;APA;AVR; MOD: LT46; - AC	6 PK 1751
				ALT	UNTIL CHA-NO.: 2D-Y-009206; MTR-CODE: AHD;ANJ;APA;AVR; MOD: LT28; + AC	6 PK 2170
				ALT	UNTIL CHA-NO.: 2D-Y-009206; MTR-CODE: AHD;ANJ;APA;AVR; MOD: LT35; + AC	6 PK 2170
				ALT	UNTIL CHA-NO.: 2D-Y-009206; MTR-CODE: AHD;ANJ;APA;AVR; MOD: LT46; + AC	6 PK 2170
				CAM		ZRK 1301
				INJ-P		ZRK 1238
				CAM		KT 1214
				CAM		KT 1302
				CAM	UNTIL: 04.06	KT 1442
				W-P; CAM		KT 1214 W1

#### 2.8 TDI

2799 ccm	92 kW	AGK	06.97 - 12.98	PS		AVX 10 x 900
				ALT	MTR-CODE: AGK;ATA; MOD: LT28; - AC	6 PK 1642
				ALT	MTR-CODE: AGK;ATA; MOD: LT28; + AC	6 PK 2130
				ALT	MTR-CODE: AGK;ATA; MOD: LT28; 2. ALT; 2 ALT	6 PK 2000
				ALT	MTR-CODE: AGK;ATA; MOD: LT35; - AC	6 PK 1642
				ALT	MTR-CODE: AGK;ATA; MOD: LT35; + AC	6 PK 2130



## VW

### LT 28-46 II Pritsche/Fahrgestell (2DX0FE)

#### 2.8 TDI

2799 ccm	92 kW	AGK	06.97 - 12.98	ALT	MTR-CODE: AGK;ATA; MOD: LT35; 2. ALT; 2 ALT	<b>6 PK 2000</b>
				ALT	MTR-CODE: AGK;ATA; MOD: LT46; - AC	<b>6 PK 1642</b>
				ALT	MTR-CODE: AGK;ATA; MOD: LT46; + AC	<b>6 PK 2130</b>
				ALT	MTR-CODE: AGK;ATA; MOD: LT46; 2. ALT; 2 ALT	<b>6 PK 2000</b>

#### 2.8 TDI

2799 ccm	96 kW	ATA	01.99 - 07.06	ALT	MTR-CODE: AGK;ATA; MOD: LT28; - AC	<b>6 PK 1642</b>
				ALT	MTR-CODE: AGK;ATA; MOD: LT28; + AC	<b>6 PK 2130</b>
				ALT	MTR-CODE: AGK;ATA; MOD: LT28; 2. ALT; 2 ALT	<b>6 PK 2000</b>
				ALT	MTR-CODE: AGK;ATA; MOD: LT35; - AC	<b>6 PK 1642</b>
				ALT	MTR-CODE: AGK;ATA; MOD: LT35; + AC	<b>6 PK 2130</b>
				ALT	MTR-CODE: AGK;ATA; MOD: LT35; 2. ALT; 2 ALT	<b>6 PK 2000</b>
				ALT	MTR-CODE: AGK;ATA; MOD: LT46; - AC	<b>6 PK 1642</b>
				ALT	MTR-CODE: AGK;ATA; MOD: LT46; + AC	<b>6 PK 2130</b>
				ALT	MTR-CODE: AGK;ATA; MOD: LT46; 2. ALT; 2 ALT	<b>6 PK 2000</b>

#### 2.8 TDI

2799 ccm	116 kW	AUH;BCQ	04.02 - 07.06	ALT	MTR-CODE: AUH;BCQ; MOD: LT28; - AC	<b>6 PK 1685</b>
				ALT	MTR-CODE: AUH;BCQ; MOD: LT28; + AC	<b>6 PK 2155</b>
				ALT	MTR-CODE: AUH;BCQ; MOD: LT35; - AC	<b>6 PK 1685</b>
				ALT	MTR-CODE: AUH;BCQ; MOD: LT35; + AC	<b>6 PK 2155</b>
				ALT	MTR-CODE: AUH;BCQ; MOD: LT46; - AC	<b>6 PK 1685</b>
				ALT	MTR-CODE: AUH;BCQ; MOD: LT46; + AC	<b>6 PK 2155</b>

### TRANSPORTER T4 Bus (70XB, 70XC, 7DB, 7DW)

#### 1.8

1781 ccm	49 kW	PD	12.90 - 07.92	ALT		<b>AVX 10 x 965</b>
				PS		<b>AVX 10 x 650</b>
				CAM		<b>ZRK 1056</b>
				CAM		<b>KT 1001</b>

#### 2.0

1968 ccm	62 kW	AAC	09.90 - 04.03	1. ALT	UNTIL: 12.95	<b>AVX 10 x 960</b>
				ALT		<b>AVX 10 x 965</b>
				PS		<b>AVX 10 x 650</b>
				ALT	+ AC	<b>6 PK 1590</b>
				ALT	2. ALT; 2 ALT	<b>6 PK 1555</b>
				ALT	FROM: 05.96; - AC; - ENG-PTO; - AMP: 120	<b>6 PK 925</b>
				ALT	FROM: 05.96; - AC; + ENG-PTO	<b>6 PK 1870</b>
				ALT	FROM: 05.96; + AC	<b>6 PK 1590</b>
				ALT	FROM: 05.96; 2. ALT; 2 ALT	<b>6 PK 1870</b>
				ALT	FROM: 05.96; AMP: 120; - AC; - ENG-PTO	<b>6 PK 1060</b>
				AUX-FAN	+ EXT-COOL	<b>2 PJ 896</b>
				HYD-P		<b>6 PK 1460</b>
				PS	FROM: 05.96; + AC	<b>6 PK 1590</b>
				CAM		<b>ZRK 1315</b>
				CAM	MTR-CODE: AAC; FROM: 01.03; FROM CHA-NO.: 70-03-000 001	<b>KT 1258</b>
				CAM	MTR-CODE: AAC; UNTIL: 01.03	<b>KT 1258</b>

#### 2.5

2461 ccm	81 kW	AAF;ACU;AEN;AEU	11.90 - 04.03	ALT	UNTIL CHA-NO.: 70M175000	<b>AVX 10 x 1140</b>
				PS	UNTIL CHA-NO.: 70M175000	<b>AVX 10 x 864</b>
				ALT	FROM: 01.94; UNTIL: 01.95; MTR-CODE: ACU	<b>6 PK 2065</b>
				ALT	FROM: 01.94; UNTIL: 01.95; MTR-CODE: ACU; - AC	<b>6 PK 1718</b>
				ALT	FROM: 01.94; UNTIL: 01.95; MTR-CODE: ACU; 2. ALT; 2 ALT	<b>6 PK 2000</b>
				ALT	FROM: 01.95; MTR-CODE: AAF;ACU;AEN;AET;AEU;ACU; + AUTO-TM; + AC	<b>6 PK 2228</b>
				ALT	FROM: 01.95; MTR-CODE: AAF;ACU;AEN;AET;AEU;ACU; + MAN-TM; + AC	<b>6 PK 2240</b>
				ALT	FROM: 01.95; MTR-CODE: AAF;ACU;AEN;AET;AEU;ACU; 2. ALT; 2 ALT	<b>6 PK 2075</b>
				ALT	FROM: 01.95; MTR-CODE: ACU; + AUTO-TM; + AC	<b>6 PK 2228</b>
				ALT	FROM: 01.95; MTR-CODE: ACU; + MAN-TM; + AC	<b>6 PK 2240</b>

**VW**
**TRANSPORTER T4 Bus (70XB, 70XC, 7DB, 7DW)**
**2.5**

2461 ccm	81 kW	AAF;ACU;AEN;AEU	11.90 - 04.03	ALT	FROM: 01.95; MTR-CODE: ACU; 2. ALT; 2 ALT	<b>6 PK 2075</b>
				ALT	FROM: 01.95; MTR-CODE: AEN; - AC	<b>6 PK 1345</b>
				ALT	FROM: 01.95; MTR-CODE: AEN; + AUTO-TM; + AC	<b>6 PK 2228</b>
				ALT	FROM: 01.95; MTR-CODE: AEN; + MAN-TM; + AC	<b>6 PK 2240</b>
				ALT	FROM: 01.95; MTR-CODE: AEN; 2. ALT; 2 ALT	<b>6 PK 2075</b>
				ALT	FROM: 01.95; UNTIL: 01.96; MTR-CODE: AAF;ACU;AEN;AET;AEU;ACU; - AC	<b>6 PK 1345</b>
				ALT	FROM: 01.95; UNTIL: 01.96; MTR-CODE: ACU; - AC	<b>6 PK 1345</b>
				ALT	FROM: 01.96; MTR-CODE: AAF;ACU;AEN;AET;AEU;ACU; - AC	<b>6 PK 1352</b>
				ALT	FROM: 01.96; MTR-CODE: ACU; - AC	<b>6 PK 1352</b>
				ALT	FROM: 05.96; MTR-CODE: AET;AEU;APL;AVT; - AC	<b>6 PK 1352</b>
				ALT	FROM: 05.96; MTR-CODE: AET;AEU;APL;AVT; + AUTO-TM; + AC	<b>6 PK 2228</b>
				ALT	FROM: 05.96; MTR-CODE: AET;AEU;APL;AVT; + MAN-TM; + AC	<b>6 PK 2240</b>
				ALT	FROM: 05.96; MTR-CODE: AET;AEU;APL;AVT; 2. ALT; 2 ALT	<b>6 PK 2075</b>
				ALT	FROM: 07.94; UNTIL: 01.95; MTR-CODE: AEN	<b>6 PK 2065</b>
				ALT	FROM: 07.94; UNTIL: 01.95; MTR-CODE: AEN; - AC	<b>6 PK 1718</b>
				ALT	FROM: 07.94; UNTIL: 01.95; MTR-CODE: AEN; 2. ALT; 2 ALT	<b>6 PK 2000</b>
				ALT	FROM: 10.91; FROM CHA-NO.: 70-N-000001; MTR-CODE: AAF	<b>6 PK 2065</b>
				ALT	FROM: 10.91; FROM CHA-NO.: 70-N-000001; MTR-CODE: AAF; - AC	<b>6 PK 1718</b>
				ALT	FROM: 10.91; FROM CHA-NO.: 70-N-000001; MTR-CODE: AAF; 2. ALT; 2 ALT	<b>6 PK 2000</b>
				ALT	FROM: 10.91; FROM CHA-NO.: 70-N-000001; MTR-CODE: AAF;AAF;ACU;AEN;AET;AEU	<b>6 PK 2065</b>
				ALT	FROM: 10.91; FROM CHA-NO.: 70-N-000001; MTR-CODE: AAF;AAF;ACU;AEN;AET;AEU; - AC	<b>6 PK 1718</b>
				ALT	FROM: 10.91; FROM CHA-NO.: 70-N-000001; MTR-CODE: AAF;AAF;ACU;AEN;AET;AEU; 2. ALT; 2 ALT	<b>6 PK 2000</b>
				ALT	MTR-CODE: AAF;ACU;AEN;AET;AEU;AEU; - AC	<b>6 PK 1352</b>
				ALT	MTR-CODE: AAF;ACU;AEN;AET;AEU;AEU; + AUTO-TM; + AC	<b>6 PK 2228</b>
				ALT	MTR-CODE: AAF;ACU;AEN;AET;AEU;AEU; + MAN-TM; + AC	<b>6 PK 2240</b>
				ALT	MTR-CODE: AAF;ACU;AEN;AET;AEU;AEU; 2. ALT; 2 ALT	<b>6 PK 2075</b>
				ALT	UNTIL: 01.95; MTR-CODE: AAF;ACU;AEN;AET;AEU;ACU	<b>6 PK 2065</b>
				ALT	UNTIL: 01.95; MTR-CODE: AAF;ACU;AEN;AET;AEU;ACU; - AC	<b>6 PK 1718</b>
				ALT	UNTIL: 01.95; MTR-CODE: AAF;ACU;AEN;AET;AEU;ACU; 2. ALT; 2 ALT	<b>6 PK 2000</b>
				HYD-P	FROM: 01.94; UNTIL: 01.95; MTR-CODE: ACU; + AC	<b>6 PK 2130</b>
				HYD-P	FROM: 01.95; MTR-CODE: AAF;ACU;AEN;AET;AEU;ACU	<b>6 PK 2130</b>
				HYD-P	FROM: 01.95; MTR-CODE: ACU	<b>6 PK 2130</b>
				HYD-P	FROM: 01.95; MTR-CODE: AEN	<b>6 PK 2130</b>
				HYD-P	FROM: 05.96; MTR-CODE: AET;AEU;APL;AVT	<b>6 PK 2130</b>
				HYD-P	FROM: 07.94; UNTIL: 01.95; MTR-CODE: AEN; + AC	<b>6 PK 2130</b>
				HYD-P	FROM: 10.91; FROM CHA-NO.: 70-N-000001; MTR-CODE: AAF; + AC	<b>6 PK 2130</b>
				HYD-P	FROM: 10.91; FROM CHA-NO.: 70-N-000001; MTR-CODE: AAF;AAF;ACU;AEN;AET;AEU; + AC	<b>6 PK 2130</b>
				HYD-P	MTR-CODE: AAF;ACU;AEN;AET;AEU;AEU	<b>6 PK 2130</b>
				HYD-P	UNTIL: 01.95; MTR-CODE: AAF;ACU;AEN;AET;AEU;ACU; + AC	<b>6 PK 2130</b>
				CAM	FROM MTR-NO: 019150; MTR-CODE: ACU	<b>ZRK 1301</b>
				CAM	FROM: 09.91; FROM CHA-NO.: 70-N-014001; MTR-CODE: AAF	<b>ZRK 1241</b>



## VW

### TRANSPORTER T4 Bus (70XB, 70XC, 7DB, 7DW)

#### 2.5

2461 ccm	81 kW	AAF;ACU;AEN;AEU	11.90 - 04.03	CAM	MTR-CODE: AEN;AEU	<b>ZRK 1301</b>
				CAM	UNTIL MTR-NO: 019149; MTR-CODE: ACU	<b>ZRK 1241</b>
				CAM	UNTIL: 09.91; UNTIL CHA-NO.: 70-N-014000; MTR-CODE: AAF	<b>ZRK 1301</b>
				CAM	FROM CHA-NO.: 70-N-014001; MTR-CODE: AAF	<b>KT 1402</b>
				CAM	FROM MTR-NO: 019150; UNTIL MTR-NO: 048994; MTR-CODE: ACU	<b>KT 1306</b>
				CAM	MTR-CODE: AEN	<b>KT 1306</b>
				CAM	UNTIL CHA-NO.: 70-N-014000; MTR-CODE: AAF	<b>KT 1171</b>
				CAM	UNTIL MTR-NO: 019149; MTR-CODE: ACU	<b>KT 1402</b>
				W-P; CAM	FROM MTR-NO: 019150; MTR-CODE: ACU	<b>KT 1306 W1</b>
				W-P; CAM	MTR-CODE: AEN;AEU	<b>KT 1306 W1</b>
				W-P; CAM	UNTIL CHA-NO.: 70-N-014000; MTR-CODE: AAF	<b>KT 1171 W1</b>

#### 2.5 Syncro

2461 ccm	81 kW	AAF;ACU;AEN;AEU	11.92 - 04.03	ALT	FROM CHA-NO.: 70-N-000001; MTR-CODE: AAF;AAF;ACU;AET	<b>6 PK 2065</b>
				ALT	FROM CHA-NO.: 70-N-000001; MTR-CODE: AAF;AAF;ACU;AET; - AC	<b>6 PK 1718</b>
				ALT	FROM CHA-NO.: 70-N-000001; MTR-CODE: AAF;AAF;ACU;AET; + AC	<b>6 PK 2130</b>
				ALT	FROM CHA-NO.: 70-N-000001; MTR-CODE: AAF;AAF;ACU;AET; 2. ALT; 2 ALT	<b>6 PK 2000</b>
				ALT	FROM: 01.94; UNTIL: 01.95; MTR-CODE: ACU	<b>6 PK 2065</b>
				ALT	FROM: 01.94; UNTIL: 01.95; MTR-CODE: ACU; - AC	<b>6 PK 1718</b>
				ALT	FROM: 01.94; UNTIL: 01.95; MTR-CODE: ACU; 2. ALT; 2 ALT	<b>6 PK 2000</b>
				ALT	FROM: 01.95; MTR-CODE: AAF;ACU;AET;ACU; + AUTO-TM; + AC	<b>6 PK 2228</b>
				ALT	FROM: 01.95; MTR-CODE: AAF;ACU;AET;ACU; + MAN-TM; + AC	<b>6 PK 2240</b>
				ALT	FROM: 01.95; MTR-CODE: AAF;ACU;AET;ACU; 2. ALT; 2 ALT	<b>6 PK 2075</b>
				ALT	FROM: 01.95; MTR-CODE: ACU; + AUTO-TM; + AC	<b>6 PK 2228</b>
				ALT	FROM: 01.95; MTR-CODE: ACU; + MAN-TM; + AC	<b>6 PK 2240</b>
				ALT	FROM: 01.95; MTR-CODE: ACU; 2. ALT; 2 ALT	<b>6 PK 2075</b>
				ALT	FROM: 01.95; UNTIL: 01.96; MTR-CODE: AAF;ACU;AET;ACU; - AC	<b>6 PK 1345</b>
				ALT	FROM: 01.95; UNTIL: 01.96; MTR-CODE: ACU; - AC	<b>6 PK 1345</b>
				ALT	FROM: 01.96; MTR-CODE: AAF;ACU;AET;ACU; - AC	<b>6 PK 1352</b>
				ALT	FROM: 01.96; MTR-CODE: ACU; - AC	<b>6 PK 1352</b>
				ALT	FROM: 05.96; MTR-CODE: AET;AEU;APL;AVT; - AC	<b>6 PK 1352</b>
				ALT	FROM: 05.96; MTR-CODE: AET;AEU;APL;AVT; + AUTO-TM; + AC	<b>6 PK 2228</b>
				ALT	FROM: 05.96; MTR-CODE: AET;AEU;APL;AVT; + MAN-TM; + AC	<b>6 PK 2240</b>
				ALT	FROM: 05.96; MTR-CODE: AET;AEU;APL;AVT; 2. ALT; 2 ALT	<b>6 PK 2075</b>
				ALT	MTR-CODE: AAF;ACU;AET;AEU; - AC	<b>6 PK 1352</b>
				ALT	MTR-CODE: AAF;ACU;AET;AEU; + AUTO-TM; + AC	<b>6 PK 2228</b>
				ALT	MTR-CODE: AAF;ACU;AET;AEU; + MAN-TM; + AC	<b>6 PK 2240</b>
				ALT	MTR-CODE: AAF;ACU;AET;AEU; 2. ALT; 2 ALT	<b>6 PK 2075</b>
				ALT	UNTIL: 01.95; MTR-CODE: AAF;ACU;AET;ACU	<b>6 PK 2065</b>
				ALT	UNTIL: 01.95; MTR-CODE: AAF;ACU;AET;ACU; - AC	<b>6 PK 1718</b>
				ALT	UNTIL: 01.95; MTR-CODE: AAF;ACU;AET;ACU; 2. ALT; 2 ALT	<b>6 PK 2000</b>
				HYD-P	FROM: 01.94; UNTIL: 01.95; MTR-CODE: ACU; + AC	<b>6 PK 2130</b>
				HYD-P	FROM: 01.95; MTR-CODE: AAF;ACU;AET;ACU	<b>6 PK 2130</b>
				HYD-P	FROM: 01.95; MTR-CODE: ACU	<b>6 PK 2130</b>
				HYD-P	FROM: 05.96; MTR-CODE: AET;AEU;APL;AVT	<b>6 PK 2130</b>

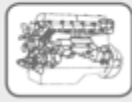
**VW**
**TRANSPORTER T4 Bus (70XB, 70XC, 7DB, 7DW)**
**2.5 Syncro**

2461 ccm	81 kW	AAF;ACU;AEN;AEU	11.92 - 04.03	HYD-P	MTR-CODE: AAF;ACU;AET;AEU	6 PK 2130
				HYD-P	UNTIL: 01.95; MTR-CODE: AAF;ACU;AET;ACU; + AC	6 PK 2130
				CAM	FROM CHA-NO.: 70-N-014001; MTR-CODE: AAF	ZRK 1241
				CAM	FROM MTR-NO: 019150; MTR-CODE: ACU	ZRK 1301
				CAM	MTR-CODE: AEN;AEU	ZRK 1301
				CAM	UNTIL MTR-NO: 019149; MTR-CODE: ACU	ZRK 1241
				CAM	FROM CHA-NO.: 70-N-014001; MTR-CODE: AAF	KT 1402
				CAM	FROM MTR-NO: 019150; UNTIL MTR-NO: 048994; MTR-CODE: ACU	KT 1306
				CAM	MTR-CODE: AEN	KT 1306
				CAM	UNTIL MTR-NO: 019149; MTR-CODE: ACU	KT 1402
				W-P; CAM	FROM MTR-NO: 019150; MTR-CODE: ACU	KT 1306 W1
				W-P; CAM	MTR-CODE: AEN;AEU	KT 1306 W1
				W-P; CAM	UNTIL CHA-NO.: 70-N-014000; MTR-CODE: AAF	KT 1171 W1

**2.5**

2461 ccm	85 kW	AET;APL;AVT	08.96 - 04.03	ALT	FROM: 05.98; MTR-CODE: AET;APL;AVT; - AC	6 PK 1352
				ALT	FROM: 05.98; MTR-CODE: AET;APL;AVT; + AUTO-TM; + AC	6 PK 2228
				ALT	FROM: 05.98; MTR-CODE: AET;APL;AVT; + MAN-TM; + AC	6 PK 2240
				ALT	FROM: 05.98; MTR-CODE: AET;APL;AVT; 2. ALT; 2 ALT	6 PK 2075
				ALT	MTR-CODE: AET;AEU;APL;AVT; - AC	6 PK 1352
				ALT	MTR-CODE: AET;AEU;APL;AVT; + AUTO-TM; + AC	6 PK 2228
				ALT	MTR-CODE: AET;AEU;APL;AVT; + MAN-TM; + AC	6 PK 2240
				ALT	MTR-CODE: AET;AEU;APL;AVT; 2. ALT; 2 ALT	6 PK 2075
				HYD-P	FROM: 05.98; MTR-CODE: AET;APL;AVT	6 PK 2130
				HYD-P	MTR-CODE: AET;AEU;APL;AVT	6 PK 2130
				CAM		ZRK 1301
				W-P; CAM		KT 1306 W1

**2.5 Syncro**

2461 ccm	85 kW	AET;APL;AVT	07.96 - 04.03	ALT	FROM: 05.99; MTR-CODE: APL;AVT; - AC	6 PK 1352
				ALT	FROM: 05.99; MTR-CODE: APL;AVT; + AUTO-TM; + AC	6 PK 2228
				ALT	FROM: 05.99; MTR-CODE: APL;AVT; + MAN-TM; + AC	6 PK 2240
				ALT	FROM: 05.99; MTR-CODE: APL;AVT; 2. ALT; 2 ALT	6 PK 2075
				ALT	MTR-CODE: AET;AEU;APL;AVT; - AC	6 PK 1352
				ALT	MTR-CODE: AET;AEU;APL;AVT; + AUTO-TM; + AC	6 PK 2228
				ALT	MTR-CODE: AET;AEU;APL;AVT; + MAN-TM; + AC	6 PK 2240
				ALT	MTR-CODE: AET;AEU;APL;AVT; 2. ALT; 2 ALT	6 PK 2075
				HYD-P	FROM: 05.99; MTR-CODE: APL;AVT	6 PK 2130
				HYD-P	MTR-CODE: AET;AEU;APL;AVT	6 PK 2130
				CAM		ZRK 1301
				W-P; CAM		KT 1306 W1

**2.8 VR 6**

2792 ccm	103 kW	AES	11.95 - 04.00	ALT	+ AC	7 DPK 1400
----------	--------	-----	---------------	-----	------	------------

**2.8 VR6**

2792 ccm	150 kW	AMV	04.00 - 04.03	ALT	- AC	7 PK 1280
				ALT	+ AC	7 DPK 1360

**1.9 D**

1896 ccm	44 kW	1X	09.90 - 12.95	ALT	UNTIL CHA-NO.: 70N200000	AVX 10 x 975
				PS		AVX 11,9 x 650
				ALT	FROM CHA-NO.: 70-P-000001; - AMP: 120	6 PK 925
				ALT	FROM CHA-NO.: 70-P-000001; AMP: 120	6 PK 1045
				CAM		ZRK 1290
				CAM	FROM MTR-NO: 120078	KT 1021
				CAM	UNTIL MTR-NO: 120077	KT 1004

**1.9 TD**

1896 ccm	50 kW	ABL	10.92 - 04.03	ALT	UNTIL CHA-NO.: 70N200000	AVX 10 x 975
----------	-------	-----	---------------	-----	--------------------------	--------------





## VW

### TRANSPORTER T4 Bus (70XB, 70XC, 7DB, 7DW)

#### 1.9 TD

1896 ccm	50 kW	ABL	10.92 - 04.03	PS		AVX 11,9 x 650
				ALT	FROM CHA-NO.: 70-P-000001; - AMP: 120	6 PK 925
				ALT	FROM CHA-NO.: 70-P-000001; AMP: 120	6 PK 1045
				CAM		ZRK 1290
				CAM	FROM MTR-NO: 029320	KT 1021
				CAM	UNTIL MTR-NO: 029319	KT 1004

#### 2.4 D

2370 ccm	55 kW	AJA	08.97 - 04.03	ALT	- AC; - ENG-PTO	6 PK 1352
				ALT	+ AC; - ENG-PTO	6 PK 2240
				ALT	+ ENG-PTO	6 PK 1718
				ALT	2. ALT; 2 ALT; + PTO	6 PK 2075
				HYD-P	FROM CHA-NO.: 70-X-140001; - ENG-PTO	6 PK 2100
				HYD-P	UNTIL CHA-NO.: 70-X-140000; - ENG-PTO	6 PK 2130
				CAM		ZRK 1301
				INJ-P		ZRK 1270
				CAM		KT 1214
				W-P; CAM		KT 1214 W1

#### 2.4 D

2370 ccm	57 kW	AAB	09.90 - 04.98	ALT	UNTIL: 07.92	AVX 10 x 1075
				PS		AVX 10 x 864
				ALT	FROM CHA-NO.: 70-N-000001; - AC; - ENG-PTO	6 PK 1352
				ALT	FROM CHA-NO.: 70-N-000001; + AC; - ENG-PTO	6 PK 2240
				ALT	FROM CHA-NO.: 70-N-000001; + ENG-PTO	6 PK 1718
				ALT	FROM CHA-NO.: 70-N-000001; 2. ALT; 2 ALT; + PTO	6 PK 2075
				HYD-P	FROM CHA-NO.: 70-X-140001; - ENG-PTO	6 PK 2100
				CAM		ZRK 1301
				INJ-P		ZRK 1270
				CAM	FROM MTR-NO: 320127	KT 1214
				CAM	UNTIL MTR-NO: 320126	KT 1171
				W-P; CAM	FROM: 07.96; FROM MTR-NO: 320127	KT 1214 W1
				W-P; CAM	UNTIL: 06.96; UNTIL MTR-NO: 320126	KT 1171 W1

#### 2.4 D Syncro

2370 ccm	57 kW	AAB	10.92 - 09.98	PS	UNTIL: 12.94	AVX 10 x 864
				ALT	FROM CHA-NO.: 70-N-000001; - AC; - ENG-PTO	6 PK 1352
				ALT	FROM CHA-NO.: 70-N-000001; + AC; - ENG-PTO	6 PK 2240
				ALT	FROM CHA-NO.: 70-N-000001; + ENG-PTO	6 PK 1718
				ALT	FROM CHA-NO.: 70-N-000001; 2. ALT; 2 ALT; + PTO	6 PK 2075
				HYD-P	FROM CHA-NO.: 70-X-140001; - ENG-PTO	6 PK 2100
				CAM		ZRK 1301
				INJ-P		ZRK 1270
				CAM	FROM MTR-NO: 320127	KT 1214
				CAM	UNTIL MTR-NO: 320126	KT 1171
				W-P; CAM	FROM: 07.96; FROM MTR-NO: 320127	KT 1214 W1
				W-P; CAM	UNTIL: 06.96; UNTIL MTR-NO: 320126	KT 1171 W1

#### 2.5 TDI

2461 ccm	65 kW	AJT;AYY	05.98 - 04.03	ALT	FROM CHA-NO.: 70-XX13365;XH132970; MTR-CODE: ACV;AHY;AJT;AUF; + AC	6 PK 2215
				ALT	FROM CHA-NO.: 70-XX13365;XH132970; MTR-CODE: AJT; + AC	6 PK 2215
				ALT	FROM CHA-NO.: X-; MTR-CODE: ACV;AHY;AJT;AUF; + AUTO-TM; - AC	6 PK 1751
				ALT	FROM CHA-NO.: X-; MTR-CODE: ACV;AHY;AJT;AUF; + MAN-TM; - AC	6 PK 1765
				ALT	FROM CHA-NO.: X-; MTR-CODE: AJT; + AUTO-TM; - AC	6 PK 1751
				ALT	FROM CHA-NO.: X-; MTR-CODE: AJT; + MAN-TM; - AC	6 PK 1765
				ALT	MTR-CODE: ACV;AHY;AJT;AUF; 2. ALT; 2 ALT	6 PK 2075
				ALT	MTR-CODE: AJT; 2. ALT; 2 ALT	6 PK 2075
				ALT	UNTIL CHA-NO.: 70-XX133656;XH132969; MTR-CODE: ACV;AHY;AJT;AUF; + AC	6 PK 2240
				ALT	UNTIL CHA-NO.: 70-XX133656;XH132969; MTR-CODE: AJT; + AC	6 PK 2240
				CAM		ZRK 1301
				INJ-P		ZRK 1238



## VW

### TRANSPORTER T4 Bus (70XB, 70XC, 7DB, 7DW)

2.5 TDI						
2461 ccm	65 kW	AJT;AYY	05.98 - 04.03	CAM		KT 1218
				CAM		KT 1302
				CAM		KT 1515
				W-P; CAM		KT 1218 W1
2.5 TDI						
2461 ccm	75 kW	ACV;AUF;AYC	09.95 - 04.03	ALT	FROM CHA-NO.: 70-XX13365;XH132970; MTR-CODE: ACV;AHY;AJT;AUF; + AC	6 PK 2215
				ALT	FROM CHA-NO.: 70-XX13365;XH132970; MTR-CODE: ACV;AUF;AYC; + AC	6 PK 2215
				ALT	FROM: 05.98; FROM CHA-NO.: X-; MTR-CODE: ACV;AHY;AJT;AUF; + AUTO-TM; - AC	6 PK 1751
				ALT	FROM: 05.98; FROM CHA-NO.: X-; MTR-CODE: ACV;AHY;AJT;AUF; + MAN-TM; - AC	6 PK 1765
				ALT	FROM: 05.98; FROM CHA-NO.: X-; MTR-CODE: ACV;AUF;ACV;AUF;AYC; + AUTO-TM; - AC	6 PK 1751
				ALT	FROM: 05.98; FROM CHA-NO.: X-; MTR-CODE: ACV;AUF;ACV;AUF;AYC; + MAN-TM; - AC	6 PK 1765
				ALT	FROM: 09.00; MTR-CODE: AXG;AXG;AYC;AYY; - AC	6 PK 1695
				ALT	FROM: 09.00; MTR-CODE: AXG;AXG;AYC;AYY; + AC	6 PK 2170
				ALT	FROM: 09.00; MTR-CODE: AXG;AYC;AYY; OE-NO.: 074903137AS; 2. ALT; 2 ALT	6 PK 2075
				ALT	FROM: 09.00; MTR-CODE: AXG;AYC;AYY; OE-NO.: 074903137BB; 2. ALT; 2 ALT	6 PK 2065
				ALT	FROM: 09.00; MTR-CODE: AXG;AYC;AYY;AYY;AYC; - AC	6 PK 1751
				ALT	FROM: 09.00; MTR-CODE: AXG;AYC;AYY;AYY;AYC; + AC	6 PK 2215
				ALT	MTR-CODE: ACV;AHY;AJT;AUF; 2. ALT; 2 ALT	6 PK 2075
				ALT	MTR-CODE: ACV;AUF;AYC; OE-NO.: 074903137AS; 2. ALT; 2 ALT	6 PK 2075
				ALT	MTR-CODE: ACV;AUF;AYC; OE-NO.: 074903137BB	6 PK 2065
				ALT	MTR-CODE: ACV;AUF;AYC;AYC; - AC	6 PK 1751
				ALT	UNTIL CHA-NO.: 70-XX133656;XH132969; MTR-CODE: ACV;AHY;AJT;AUF; + AC	6 PK 2240
				ALT	UNTIL CHA-NO.: 70-XX133656;XH132969; MTR-CODE: ACV;AUF;AYC; + AC	6 PK 2240
				ALT	UNTIL: 04.98; UNTIL CHA-NO.: W-; MTR-CODE: ACV;AHY;AJT;AUF; - AC	6 PK 1765
				ALT	UNTIL: 04.98; UNTIL CHA-NO.: W-; MTR-CODE: ACV;AUF;ACV;AUF;AYC; - AC	6 PK 1765
				CAM		ZRK 1301
				INJ-P		ZRK 1238
				CAM		KT 1214
				CAM		KT 1302
				W-P; CAM		KT 1214 W1
2.5 TDI Syncro						
2461 ccm	75 kW	ACV;AXL	01.96 - 04.03	ALT	FROM CHA-NO.: 70-XX13365;XH132970; MTR-CODE: ACV; + AC	6 PK 2215
				ALT	FROM CHA-NO.: 70-XX13365;XH132970; MTR-CODE: ACV;AHY;AJT;AUF; + AC	6 PK 2215
				ALT	FROM: 05.98; FROM CHA-NO.: X-; MTR-CODE: ACV; + AUTO-TM; - AC	6 PK 1751
				ALT	FROM: 05.98; FROM CHA-NO.: X-; MTR-CODE: ACV; + MAN-TM; - AC	6 PK 1765
				ALT	FROM: 05.98; FROM CHA-NO.: X-; MTR-CODE: ACV;AHY;AJT;AUF; + AUTO-TM; - AC	6 PK 1751
				ALT	FROM: 05.98; FROM CHA-NO.: X-; MTR-CODE: ACV;AHY;AJT;AUF; + MAN-TM; - AC	6 PK 1765
				ALT	MTR-CODE: ACV; 2. ALT; 2 ALT	6 PK 2075
				ALT	MTR-CODE: ACV;AHY;AJT;AUF; 2. ALT; 2 ALT	6 PK 2075
				ALT	UNTIL CHA-NO.: 70-XX133656;XH132969; MTR-CODE: ACV; + AC	6 PK 2240
				ALT	UNTIL CHA-NO.: 70-XX133656;XH132969; MTR-CODE: ACV;AHY;AJT;AUF; + AC	6 PK 2240
				ALT	UNTIL: 04.98; UNTIL CHA-NO.: W-; MTR-CODE: ACV; - AC	6 PK 1765
				ALT	UNTIL: 04.98; UNTIL CHA-NO.: W-; MTR-CODE: ACV;AHY;AJT;AUF; - AC	6 PK 1765



## VW

### TRANSPORTER T4 Bus (70XB, 70XC, 7DB, 7DW)

#### 2.5 TDI Syncro

2461 ccm	75 kW	ACV;AXL	01.96 - 04.03	CAM		ZRK 1301
				INJ-P		ZRK 1238
				CAM		KT 1214
				CAM		KT 1302
				CAM		KT 1515
				CAM	MTR-CODE: ACV; FROM: 03.98	KT 1442
				W-P; CAM	MTR-CODE: ACV	KT 1214 W1
				W-P; CAM	MTR-CODE: AXL	KT 1218 W1

#### 2.5 TDI

2461 ccm	111 kW	AHY;AXG	05.98 - 04.03	ALT	FROM CHA-NO.: 70-XX13365;XH132970; MTR-CODE: ACV;AHY;AJT;AUF; + AC	6 PK 2215
				ALT	FROM CHA-NO.: 70-XX13365;XH132970; MTR-CODE: AHY;AHY;AXG; + AC	6 PK 2215
				ALT	FROM CHA-NO.: X-; MTR-CODE: ACV;AHY;AJT;AUF; + AUTO-TM; - AC	6 PK 1751
				ALT	FROM CHA-NO.: X-; MTR-CODE: ACV;AHY;AJT;AUF; + MAN-TM; - AC	6 PK 1765
				ALT	FROM CHA-NO.: X-; MTR-CODE: AHY;AHY;AXG; + AUTO-TM; - AC	6 PK 1751
				ALT	FROM CHA-NO.: X-; MTR-CODE: AHY;AHY;AXG; + MAN-TM; - AC	6 PK 1765
				ALT	FROM: 09.00; MTR-CODE: AXG;AXG;AYC;AYY; - AC	6 PK 1695
				ALT	FROM: 09.00; MTR-CODE: AXG;AXG;AYC;AYY; + AC	6 PK 2170
				ALT	FROM: 09.00; MTR-CODE: AXG;AYC;AYY; OE-NO.: 074903137AS; 2. ALT; 2 ALT	6 PK 2075
				ALT	FROM: 09.00; MTR-CODE: AXG;AYC;AYY; OE-NO.: 074903137BB; 2. ALT; 2 ALT	6 PK 2065
				ALT	FROM: 09.00; MTR-CODE: AXG;AYC;AYY;AYY;AYC; - AC	6 PK 1751
				ALT	FROM: 09.00; MTR-CODE: AXG;AYC;AYY;AYY;AYC; + AC	6 PK 2215
				ALT	MTR-CODE: ACV;AHY;AJT;AUF; 2. ALT; 2 ALT	6 PK 2075
				ALT	MTR-CODE: AHY;AXG; OE-NO.: 074903137AS; 2. ALT; 2 ALT	6 PK 2075
				ALT	MTR-CODE: AHY;AXG; OE-NO.: 074903137BB; 2. ALT; 2 ALT	6 PK 2065
				ALT	MTR-CODE: AHY;AXG;AXG; - AC	6 PK 1695
				ALT	MTR-CODE: AHY;AXG;AXG; + AC	6 PK 2170
				ALT	UNTIL CHA-NO.: 70-XX133656;XH132969; MTR-CODE: ACV;AHY;AJT;AUF; + AC	6 PK 2240
				ALT	UNTIL CHA-NO.: 70-XX133656;XH132969; MTR-CODE: AHY;AHY;AXG; + AC	6 PK 2240
				CAM		ZRK 1301
				INJ-P		ZRK 1238
				CAM		KT 1218
				CAM		KT 1302
				CAM		KT 1515
				W-P; CAM		KT 1218 W1

### TRANSPORTER T4 Kasten (70XA)

#### 2.0

1968 ccm	62 kW	AAC	07.90 - 04.03	1. ALT	UNTIL: 12.95	AVX 10 x 960
				PS		AVX 10 x 650
				ALT	+ AC	6 PK 1590
				ALT	2. ALT; 2 ALT	6 PK 1555
				ALT	FROM: 05.96; - AC; - ENG-PTO; - AMP: 120	6 PK 925
				ALT	FROM: 05.96; - AC; + ENG-PTO	6 PK 1870
				ALT	FROM: 05.96; 2. ALT; 2 ALT	6 PK 1870
				ALT	FROM: 05.96; AMP: 120; - AC; - ENG-PTO	6 PK 1060
				AUX-FAN	+ EXT-COOL	2 PJ 896
				HYD-P		6 PK 1460
				PS	FROM: 05.96; + AC	6 PK 1590
				CAM		ZRK 1315
				CAM	MTR-CODE: AAC; FROM: 01.03; FROM CHA-NO.: 70-03-000 001	KT 1258
				CAM	MTR-CODE: AAC; UNTIL: 01.03	KT 1258

#### 2.5

2461 ccm	81 kW	AAF;ACU;AEN;AEU	11.90 - 04.03	ALT	UNTIL: 12.91	AVX 10 x 1075
----------	-------	-----------------	---------------	-----	--------------	---------------

**VW**
**TRANSPORTER T4 Kasten (70XA)**
**2.5**

2461 ccm	81 kW	AAF;ACU;AEN;AEU	11.90 - 04.03	ALT	UNTIL: 12.91; + PTO	<b>AVX 10 x 1140</b>
				PS	UNTIL: 12.91	<b>AVX 10 x 864</b>
				ALT	FROM: 01.94; UNTIL: 01.95; MTR-CODE: ACU	<b>6 PK 2065</b>
				ALT	FROM: 01.94; UNTIL: 01.95; MTR-CODE: ACU; - AC	<b>6 PK 1718</b>
				ALT	FROM: 01.94; UNTIL: 01.95; MTR-CODE: ACU; 2. ALT; 2 ALT	<b>6 PK 2000</b>
				ALT	FROM: 01.95; MTR-CODE: ACU; + AUTO-TM; + AC	<b>6 PK 2228</b>
				ALT	FROM: 01.95; MTR-CODE: ACU; + MAN-TM; + AC	<b>6 PK 2240</b>
				ALT	FROM: 01.95; MTR-CODE: ACU; 2. ALT; 2 ALT	<b>6 PK 2075</b>
				ALT	FROM: 01.95; MTR-CODE: AEN; - AC	<b>6 PK 1345</b>
				ALT	FROM: 01.95; MTR-CODE: AEN; + AUTO-TM; + AC	<b>6 PK 2228</b>
				ALT	FROM: 01.95; MTR-CODE: AEN; + MAN-TM; + AC	<b>6 PK 2240</b>
				ALT	FROM: 01.95; MTR-CODE: AEN; 2. ALT; 2 ALT	<b>6 PK 2075</b>
				ALT	FROM: 01.95; UNTIL: 01.96; MTR-CODE: ACU; - AC	<b>6 PK 1345</b>
				ALT	FROM: 01.96; MTR-CODE: ACU; - AC	<b>6 PK 1352</b>
				ALT	FROM: 05.96; MTR-CODE: AET;AEU;APL;AVT; - AC	<b>6 PK 1352</b>
				ALT	FROM: 05.96; MTR-CODE: AET;AEU;APL;AVT; + AUTO-TM; + AC	<b>6 PK 2228</b>
				ALT	FROM: 05.96; MTR-CODE: AET;AEU;APL;AVT; + MAN-TM; + AC	<b>6 PK 2240</b>
				ALT	FROM: 05.96; MTR-CODE: AET;AEU;APL;AVT; 2. ALT; 2 ALT	<b>6 PK 2075</b>
				ALT	FROM: 07.94; UNTIL: 01.95; MTR-CODE: AEN	<b>6 PK 2065</b>
				ALT	FROM: 07.94; UNTIL: 01.95; MTR-CODE: AEN; - AC	<b>6 PK 1718</b>
				ALT	FROM: 07.94; UNTIL: 01.95; MTR-CODE: AEN; 2. ALT; 2 ALT	<b>6 PK 2000</b>
				ALT	FROM: 10.91; FROM CHA-NO.: 70-N-000001; MTR-CODE: AAF	<b>6 PK 2065</b>
				ALT	FROM: 10.91; FROM CHA-NO.: 70-N-000001; MTR-CODE: AAF; - AC	<b>6 PK 1718</b>
				ALT	FROM: 10.91; FROM CHA-NO.: 70-N-000001; MTR-CODE: AAF; 2. ALT; 2 ALT	<b>6 PK 2000</b>
				HYD-P	FROM: 01.94; UNTIL: 01.95; MTR-CODE: ACU; + AC	<b>6 PK 2130</b>
				HYD-P	FROM: 01.95; MTR-CODE: ACU	<b>6 PK 2130</b>
				HYD-P	FROM: 01.95; MTR-CODE: AEN	<b>6 PK 2130</b>
				HYD-P	FROM: 05.96; MTR-CODE: AET;AEU;APL;AVT	<b>6 PK 2130</b>
				HYD-P	FROM: 07.94; UNTIL: 01.95; MTR-CODE: AEN; + AC	<b>6 PK 2130</b>
				HYD-P	FROM: 10.91; FROM CHA-NO.: 70-N-000001; MTR-CODE: AAF; + AC	<b>6 PK 2130</b>
				CAM	FROM MTR-NO: 019150; MTR-CODE: ACU	<b>ZRK 1301</b>
				CAM	FROM: 09.91; FROM CHA-NO.: 70-N-014001; MTR-CODE: AAF	<b>ZRK 1241</b>
				CAM	MTR-CODE: AEN;AEU	<b>ZRK 1301</b>
				CAM	UNTIL MTR-NO: 019149; MTR-CODE: ACU	<b>ZRK 1241</b>
				CAM	UNTIL: 09.91; UNTIL CHA-NO.: 70-N-014000; MTR-CODE: AAF	<b>ZRK 1301</b>
				CAM	FROM CHA-NO.: 70-N-014001; MTR-CODE: AAF	<b>KT 1402</b>
				CAM	FROM MTR-NO: 019150; UNTIL MTR-NO: 048994; MTR-CODE: ACU	<b>KT 1306</b>
				CAM	MTR-CODE: AEN	<b>KT 1306</b>
				CAM	UNTIL CHA-NO.: 70-N-014000; MTR-CODE: AAF	<b>KT 1171</b>
				CAM	UNTIL MTR-NO: 019149; MTR-CODE: ACU	<b>KT 1402</b>
				W-P; CAM	FROM MTR-NO: 019150; MTR-CODE: ACU	<b>KT 1306 W1</b>
				W-P; CAM	MTR-CODE: AEN;AEU	<b>KT 1306 W1</b>
				W-P; CAM	UNTIL CHA-NO.: 70-N-014000; MTR-CODE: AAF	<b>KT 1171 W1</b>

**2.5 Syncro**

2461 ccm	81 kW	AAF;ACU;AEN;AEU	10.92 - 04.03	ALT	FROM CHA-NO.: 70-N-000001; MTR-CODE: AAF; - AC	<b>6 PK 1718</b>
----------	-------	-----------------	---------------	-----	--	------------------



## VW

### TRANSPORTER T4 Kasten (70XA)

#### 2.5 Syncro

2461 ccm	81 kW	AAF;ACU;AEN;AEU	10.92 - 04.03	ALT	FROM CHA-NO.: 70-N-000001; MTR-CODE: AAF; + AC	6 PK 2130
				ALT	FROM CHA-NO.: 70-N-000001; MTR-CODE: AAF; 2. ALT; 2 ALT	6 PK 2000
				ALT	FROM: 01.94; UNTIL: 01.95; MTR-CODE: ACU	6 PK 2065
				ALT	FROM: 01.94; UNTIL: 01.95; MTR-CODE: ACU; - AC	6 PK 1718
				ALT	FROM: 01.94; UNTIL: 01.95; MTR-CODE: ACU; 2. ALT; 2 ALT	6 PK 2000
				ALT	FROM: 01.95; MTR-CODE: ACU; + AUTO-TM; + AC	6 PK 2228
				ALT	FROM: 01.95; MTR-CODE: ACU; + MAN-TM; + AC	6 PK 2240
				ALT	FROM: 01.95; MTR-CODE: ACU; 2. ALT; 2 ALT	6 PK 2075
				ALT	FROM: 01.95; UNTIL: 01.96; MTR-CODE: ACU; - AC	6 PK 1345
				ALT	FROM: 01.96; MTR-CODE: ACU; - AC	6 PK 1352
				ALT	FROM: 05.96; MTR-CODE: AET;AEU;APL;AVT; - AC	6 PK 1352
				ALT	FROM: 05.96; MTR-CODE: AET;AEU;APL;AVT; + AUTO-TM; + AC	6 PK 2228
				ALT	FROM: 05.96; MTR-CODE: AET;AEU;APL;AVT; + MAN-TM; + AC	6 PK 2240
				ALT	FROM: 05.96; MTR-CODE: AET;AEU;APL;AVT; 2. ALT; 2 ALT	6 PK 2075
				HYD-P	FROM CHA-NO.: 70-N-000001; MTR-CODE: AAF	6 PK 2065
				HYD-P	FROM: 01.94; UNTIL: 01.95; MTR-CODE: ACU; + AC	6 PK 2130
				HYD-P	FROM: 01.95; MTR-CODE: ACU	6 PK 2130
				HYD-P	FROM: 05.96; MTR-CODE: AET;AEU;APL;AVT	6 PK 2130
				CAM	FROM CHA-NO.: 70-N-014001; MTR-CODE: AAF	ZRK 1241
				CAM	FROM MTR-NO: 019150; MTR-CODE: ACU	ZRK 1301
				CAM	MTR-CODE: AEN;AEU	ZRK 1301
				CAM	UNTIL MTR-NO: 019149; MTR-CODE: ACU	ZRK 1241
				CAM	FROM CHA-NO.: 70-N-014001; MTR-CODE: AAF	KT 1402
				CAM	FROM MTR-NO: 019150; UNTIL MTR-NO: 048994; MTR-CODE: ACU	KT 1306
				CAM	MTR-CODE: AEN	KT 1306
				CAM	UNTIL MTR-NO: 019149; MTR-CODE: ACU	KT 1402
				W-P; CAM	FROM MTR-NO: 019150; MTR-CODE: ACU	KT 1306 W1
				W-P; CAM	MTR-CODE: AEN;AEU	KT 1306 W1
				W-P; CAM	UNTIL CHA-NO.: 70-N-014000; MTR-CODE: AAF	KT 1171 W1

#### 2.5

2461 ccm	85 kW	AET;APL;AVT	08.96 - 04.03	ALT	- AC	6 PK 1352
				ALT	+ AUTO-TM; + AC	6 PK 2228
				ALT	+ MAN-TM; + AC	6 PK 2240
				ALT	2. ALT; 2 ALT	6 PK 2075
				HYD-P		6 PK 2130
				CAM		ZRK 1301
				W-P; CAM		KT 1306 W1

#### 2.5 Syncro

2461 ccm	85 kW	AET;APL;AVT	08.96 - 04.03	ALT	- AC	6 PK 1352
				ALT	+ AUTO-TM; + AC	6 PK 2228
				ALT	+ MAN-TM; + AC	6 PK 2240
				ALT	2. ALT; 2 ALT	6 PK 2075
				HYD-P		6 PK 2130
				CAM		ZRK 1301
				W-P; CAM		KT 1306 W1

#### 2.8 VR6

2792 ccm	103 kW	AES	05.96 - 05.00	ALT	+ AC	7 DPK 1400
----------	--------	-----	---------------	-----	------	------------

#### 2.8 VR6

2792 ccm	150 kW	AMV	06.00 - 04.03	ALT	- AC	7 PK 1280
				ALT	+ AC	7 DPK 1360

#### 1.9 D

1896 ccm	45 kW	1X	07.90 - 12.95	ALT	UNTIL CHA-NO.: 70N200000	AVX 10 x 975
				PS		AVX 11,9 x 650

**VW**
**TRANSPORTER T4 Kasten (70XA)**

<b>1.9 D</b>						
1896 ccm	45 kW	1X	07.90 - 12.95	ALT	FROM CHA-NO.: 70-P-000001; - AMP: 120	<b>6 PK 925</b>
				ALT	FROM CHA-NO.: 70-P-000001; AMP: 120	<b>6 PK 1045</b>
				CAM		<b>ZRK 1290</b>
				CAM	FROM MTR-NO: 120078	<b>KT 1021</b>
				CAM	UNTIL MTR-NO: 120077	<b>KT 1004</b>
<b>1.9 TD</b>						
1896 ccm	50 kW	ABL	10.92 - 04.03	ALT	UNTIL CHA-NO.: 70N200000	<b>AVX 10 x 975</b>
				PS		<b>AVX 11,9 x 650</b>
				ALT	FROM: 07.94; FROM CHA-NO.: 70-P-000001; - AMP: 120	<b>6 PK 925</b>
				ALT	FROM: 07.94; FROM CHA-NO.: 70-P-000001; AMP: 120	<b>6 PK 1045</b>
				CAM		<b>ZRK 1290</b>
				CAM	FROM MTR-NO: 029320	<b>KT 1021</b>
				CAM	UNTIL MTR-NO: 029319	<b>KT 1004</b>
<b>2.4 D</b>						
2370 ccm	55 kW	AJA	08.97 - 04.03	ALT	- AC; - ENG-PTO	<b>6 PK 1352</b>
				ALT	+ AC; - ENG-PTO	<b>6 PK 2240</b>
				ALT	+ ENG-PTO	<b>6 PK 1718</b>
				ALT	2. ALT; 2 ALT; + PTO	<b>6 PK 2075</b>
				HYD-P	FROM CHA-NO.: 70-X-140001; - ENG-PTO	<b>6 PK 2100</b>
				HYD-P	UNTIL CHA-NO.: 70-X-140000; - ENG-PTO	<b>6 PK 2130</b>
				CAM		<b>ZRK 1301</b>
				INJ-P		<b>ZRK 1270</b>
				CAM		<b>KT 1214</b>
				W-P; CAM		<b>KT 1214 W1</b>
<b>2.4 D</b>						
2370 ccm	57 kW	AAB	07.90 - 04.98	ALT	UNTIL: 07.92	<b>AVX 10 x 1075</b>
				ALT	UNTIL: 07.92; + PTO	<b>AVX 10 x 1150</b>
				PS	UNTIL: 12.94	<b>AVX 10 x 864</b>
				ALT	FROM CHA-NO.: 70-N-000001; - AC; - ENG-PTO	<b>6 PK 1352</b>
				ALT	FROM CHA-NO.: 70-N-000001; + AC; - ENG-PTO	<b>6 PK 2240</b>
				ALT	FROM CHA-NO.: 70-N-000001; + ENG-PTO	<b>6 PK 1718</b>
				ALT	FROM CHA-NO.: 70-N-000001; 2. ALT; 2 ALT; + PTO	<b>6 PK 2075</b>
				HYD-P	FROM CHA-NO.: 70-X-140001; - ENG-PTO	<b>6 PK 2100</b>
				CAM		<b>ZRK 1301</b>
				INJ-P		<b>ZRK 1270</b>
				CAM	FROM MTR-NO: 320127	<b>KT 1214</b>
				CAM	UNTIL MTR-NO: 320126	<b>KT 1171</b>
				W-P; CAM	FROM: 07.96; FROM MTR-NO: 320127	<b>KT 1214 W1</b>
				W-P; CAM	UNTIL: 06.96; UNTIL MTR-NO: 320126	<b>KT 1171 W1</b>
<b>2.4 D Syncro</b>						
2370 ccm	57 kW	AAB	10.92 - 09.98	PS	UNTIL: 12.94	<b>AVX 10 x 864</b>
				ALT	FROM CHA-NO.: 70-N-000001; - AC; - ENG-PTO	<b>6 PK 1352</b>
				ALT	FROM CHA-NO.: 70-N-000001; + AC; - ENG-PTO	<b>6 PK 2240</b>
				ALT	FROM CHA-NO.: 70-N-000001; + ENG-PTO	<b>6 PK 1718</b>
				ALT	FROM CHA-NO.: 70-N-000001; 2. ALT; 2 ALT; + PTO	<b>6 PK 2075</b>
				HYD-P	FROM CHA-NO.: 70-X-140001; - ENG-PTO	<b>6 PK 2100</b>
				CAM		<b>ZRK 1301</b>
				INJ-P		<b>ZRK 1270</b>
				CAM	FROM MTR-NO: 320127	<b>KT 1214</b>
				CAM	UNTIL MTR-NO: 320126	<b>KT 1171</b>
				W-P; CAM	FROM: 07.96; FROM MTR-NO: 320127	<b>KT 1214 W1</b>
				W-P; CAM	UNTIL: 06.96; UNTIL MTR-NO: 320126	<b>KT 1171 W1</b>
<b>2.5 TDI</b>						
2461 ccm	65 kW	AJT;AYY	12.98 - 04.03	ALT	2. ALT; 2 ALT	<b>6 PK 2075</b>
				ALT	FROM CHA-NO.: 70-XX13365;XH132970; + AC	<b>6 PK 2215</b>
				ALT	FROM CHA-NO.: X-; + AUTO-TM; - AC	<b>6 PK 1751</b>
				ALT	FROM CHA-NO.: X-; + MAN-TM; - AC	<b>6 PK 1765</b>
				ALT	UNTIL CHA-NO.: 70-XX133656;XH132969; + AC	<b>6 PK 2240</b>
				CAM		<b>ZRK 1301</b>
				INJ-P		<b>ZRK 1238</b>
				CAM		<b>KT 1218</b>
				CAM		<b>KT 1302</b>



## VW

### TRANSPORTER T4 Kasten (70XA)

#### 2.5 TDI

2461 ccm	65 kW	AJT;AYY	12.98 - 04.03	CAM		KT 1515
				W-P; CAM		KT 1218 W1

#### 2.5 TDI

2461 ccm	75 kW	ACV;AUF;AYC	09.95 - 04.03	ALT	FROM CHA-NO.: 70-XX13365;XH132970; MTR-CODE: ACV;AHY;AJT;AUF; + AC	6 PK 2215
				ALT	FROM: 05.98; FROM CHA-NO.: X-; MTR-CODE: ACV;AHY;AJT;AUF; + AUTO-TM; - AC	6 PK 1751
				ALT	FROM: 05.98; FROM CHA-NO.: X-; MTR-CODE: ACV;AHY;AJT;AUF; + MAN-TM; - AC	6 PK 1765
				ALT	FROM: 09.00; MTR-CODE: AXG;AXG;AYC;AYY; - AC	6 PK 1695
				ALT	FROM: 09.00; MTR-CODE: AXG;AXG;AYC;AYY; + AC	6 PK 2170
				ALT	FROM: 09.00; MTR-CODE: AXG;AYC;AYY; OE-NO.: 074903137AS; 2. ALT; 2 ALT	6 PK 2075
				ALT	FROM: 09.00; MTR-CODE: AXG;AYC;AYY;AYY;AYC; - AC	6 PK 1751
				ALT	FROM: 09.00; MTR-CODE: AXG;AYC;AYY;AYY;AYC; + AC	6 PK 2215
				ALT	MTR-CODE: ACV;AHY;AJT;AUF; 2. ALT; 2 ALT	6 PK 2075
				ALT	UNTIL CHA-NO.: 70-XX133656;XH132969; MTR-CODE: ACV;AHY;AJT;AUF; + AC	6 PK 2240
				ALT	UNTIL: 04.98; UNTIL CHA-NO.: W-; MTR-CODE: ACV;AHY;AJT;AUF; - AC	6 PK 1765
				HYD-P	FROM: 09.00; MTR-CODE: AXG;AYC;AYY; OE-NO.: 074903137BB; 2. ALT; 2 ALT	6 PK 2065
				CAM		ZRK 1301
				INJ-P		ZRK 1238
				CAM		KT 1214
				CAM		KT 1302
				W-P; CAM		KT 1214 W1

#### 2.5 TDI Syncro

2461 ccm	75 kW	ACV;AXL	09.95 - 04.03	ALT	2. ALT; 2 ALT	6 PK 2075
				ALT	FROM CHA-NO.: 70-XX13365;XH132970; + AC	6 PK 2215
				ALT	FROM: 05.98; FROM CHA-NO.: X-; + AUTO-TM; - AC	6 PK 1751
				ALT	FROM: 05.98; FROM CHA-NO.: X-; + MAN-TM; - AC	6 PK 1765
				ALT	UNTIL CHA-NO.: 70-XX133656;XH132969; + AC	6 PK 2240
				ALT	UNTIL: 04.98; UNTIL CHA-NO.: W-; - AC	6 PK 1765
				CAM		ZRK 1301
				INJ-P		ZRK 1238
				CAM		KT 1214
				CAM		KT 1302
				CAM	FROM: 01.96	KT 1515
				CAM	MTR-CODE: ACV; FROM: 03.98	KT 1442
				W-P; CAM	MTR-CODE: ACV	KT 1214 W1
				W-P; CAM	MTR-CODE: AXL	KT 1218 W1

#### 2.5 TDI

2461 ccm	111 kW	AXG	09.00 - 04.03	ALT	FROM CHA-NO.: 70-XX13365;XH132970; MTR-CODE: ACV;AHY;AJT;AUF; + AC	6 PK 2215
				ALT	FROM CHA-NO.: X-; MTR-CODE: ACV;AHY;AJT;AUF; + AUTO-TM; - AC	6 PK 1751
				ALT	MTR-CODE: ACV;AHY;AJT;AUF; 2. ALT; 2 ALT	6 PK 2075
				ALT	MTR-CODE: AXG;AXG;AYC;AYY; - AC	6 PK 1695
				ALT	MTR-CODE: AXG;AXG;AYC;AYY; + AC	6 PK 2170
				ALT	MTR-CODE: AXG;AYC;AYY; OE-NO.: 074903137AS; 2. ALT; 2 ALT	6 PK 2075
				ALT	MTR-CODE: AXG;AYC;AYY; OE-NO.: 074903137BB; 2. ALT; 2 ALT	6 PK 2065
				ALT	MTR-CODE: AXG;AYC;AYY;AYY;AYC; - AC	6 PK 1751
				ALT	MTR-CODE: AXG;AYC;AYY;AYY;AYC; + AC	6 PK 2215
				CAM		ZRK 1301
				INJ-P		ZRK 1238
				CAM		KT 1218
				CAM		KT 1302
				CAM		KT 1515
				W-P; CAM		KT 1218 W1

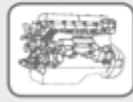
**VW**
**TRANSPORTER T4 Pritsche/Fahrgestell (70XD)**
**1.8**

1781 ccm	49 kW	PD	12.90 - 07.92	AUX-FAN CAM CAM	+ EXT-COOL	<b>2 PJ 896</b> <b>ZRK 1056</b> <b>KT 1001</b>
----------	-------	----	---------------	-----------------------	------------	--

**2.0**

1968 ccm	62 kW	AAC	07.90 - 04.03	1. ALT PS ALT ALT ALT ALT ALT ALT AUX-FAN HYD-P PS CAM CAM CAM	UNTIL: 12.95 + AC 2. ALT; 2 ALT FROM: 05.96; - AC; - ENG-PTO; - AMP: 120 FROM: 05.96; - AC; + ENG-PTO FROM: 05.96; 2. ALT; 2 ALT FROM: 05.96; AMP: 120; - AC; - ENG-PTO + EXT-COOL FROM: 05.96; + AC MTR-CODE: AAC; FROM: 01.03; FROM CHA-NO.: 70-03-000 001 MTR-CODE: AAC; UNTIL: 01.03	<b>AVX 10 x 960</b> <b>AVX 10 x 650</b> <b>6 PK 1590</b> <b>6 PK 1555</b> <b>6 PK 925</b> <b>6 PK 1870</b> <b>6 PK 1870</b> <b>6 PK 1060</b> <b>2 PJ 896</b> <b>6 PK 1460</b> <b>6 PK 1590</b> <b>ZRK 1315</b> <b>KT 1258</b> <b>KT 1258</b>
----------	-------	-----	---------------	---	--	---

**2.5**

2461 ccm	81 kW	AAF;ACU;AEN;AEU	11.90 - 04.03	ALT ALT PS ALT HYD-P HYD-P HYD-P HYD-P HYD-P CAM	UNTIL: 12.91 UNTIL: 12.91; + PTO UNTIL: 12.91 FROM: 01.94; UNTIL: 01.95; MTR-CODE: ACU FROM: 01.94; UNTIL: 01.95; MTR-CODE: ACU; - AC FROM: 01.94; UNTIL: 01.95; MTR-CODE: ACU; 2. ALT; 2 ALT FROM: 01.95; MTR-CODE: ACU; + AUTO-TM; + AC FROM: 01.95; MTR-CODE: ACU; + MAN-TM; + AC FROM: 01.95; MTR-CODE: ACU; 2. ALT; 2 ALT FROM: 01.95; MTR-CODE: AEN; - AC FROM: 01.95; MTR-CODE: AEN; + AUTO-TM; + AC FROM: 01.95; MTR-CODE: AEN; + MAN-TM; + AC FROM: 01.95; MTR-CODE: AEN; 2. ALT; 2 ALT FROM: 01.95; UNTIL: 01.96; MTR-CODE: ACU; - AC FROM: 01.96; MTR-CODE: ACU; - AC FROM: 05.96; MTR-CODE: AET;AEU;APL;AVT; - AC FROM: 05.96; MTR-CODE: AET;AEU;APL;AVT; + AUTO-TM; + AC FROM: 05.96; MTR-CODE: AET;AEU;APL;AVT; + MAN-TM; + AC FROM: 05.96; MTR-CODE: AET;AEU;APL;AVT; 2. ALT; 2 ALT FROM: 07.94; UNTIL: 01.95; MTR-CODE: AEN FROM: 07.94; UNTIL: 01.95; MTR-CODE: AEN; - AC FROM: 07.94; UNTIL: 01.95; MTR-CODE: AEN; 2. ALT; 2 ALT FROM: 10.91; FROM CHA-NO.: 70-N-000001; MTR-CODE: AAF FROM: 10.91; FROM CHA-NO.: 70-N-000001; MTR-CODE: AAF; - AC FROM: 10.91; FROM CHA-NO.: 70-N-000001; MTR-CODE: AAF; 2. ALT; 2 ALT FROM: 01.94; UNTIL: 01.95; MTR-CODE: ACU; + AC FROM: 01.95; MTR-CODE: ACU FROM: 01.95; MTR-CODE: AEN FROM: 05.96; MTR-CODE: AET;AEU;APL;AVT FROM: 07.94; UNTIL: 01.95; MTR-CODE: AEN; + AC FROM: 10.91; FROM CHA-NO.: 70-N-000001; MTR-CODE: AAF; + AC FROM MTR-NO: 019150; MTR-CODE: ACU	<b>AVX 10 x 1075</b> <b>AVX 10 x 1140</b> <b>AVX 10 x 864</b> <b>6 PK 2065</b> <b>6 PK 1718</b> <b>6 PK 2000</b> <b>6 PK 2228</b> <b>6 PK 2240</b> <b>6 PK 2075</b> <b>6 PK 1345</b> <b>6 PK 2228</b> <b>6 PK 2240</b> <b>6 PK 2075</b> <b>6 PK 1345</b> <b>6 PK 1352</b> <b>6 PK 1352</b> <b>6 PK 2228</b> <b>6 PK 2240</b> <b>6 PK 2075</b> <b>6 PK 2065</b> <b>6 PK 1718</b> <b>6 PK 2000</b> <b>6 PK 2065</b> <b>6 PK 1718</b> <b>6 PK 2000</b> <b>6 PK 2130</b> <b>6 PK 2130</b> <b>6 PK 2130</b> <b>6 PK 2130</b> <b>6 PK 2130</b> <b>ZRK 1301</b>
----------	-------	-----------------	---------------	--	--	--



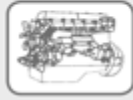

## VW

### TRANSPORTER T4 Pritsche/Fahrgestell (70XD)

2.5						
2461 ccm	81 kW	AAF;ACU;AEN;AEU	11.90 - 04.03	CAM	FROM: 09.91; FROM CHA-NO.: 70-N-014001; MTR-CODE: AAF	<b>ZRK 1241</b>
				CAM	MTR-CODE: AEN;AEU	<b>ZRK 1301</b>
				CAM	UNTIL MTR-NO: 019149; MTR-CODE: ACU	<b>ZRK 1241</b>
				CAM	UNTIL: 09.91; UNTIL CHA-NO.: 70-N-014000; MTR-CODE: AAF	<b>ZRK 1301</b>
				CAM	FROM CHA-NO.: 70-N-014001; MTR-CODE: AAF	<b>KT 1402</b>
				CAM	FROM MTR-NO: 019150; UNTIL MTR-NO: 048994; MTR-CODE: ACU	<b>KT 1306</b>
				CAM	MTR-CODE: AEN	<b>KT 1306</b>
				CAM	UNTIL CHA-NO.: 70-N-014000; MTR-CODE: AAF	<b>KT 1171</b>
				CAM	UNTIL MTR-NO: 019149; MTR-CODE: ACU	<b>KT 1402</b>
				W-P; CAM	FROM MTR-NO: 019150; MTR-CODE: ACU	<b>KT 1306 W1</b>
				W-P; CAM	MTR-CODE: AEN;AEU	<b>KT 1306 W1</b>
				W-P; CAM	UNTIL CHA-NO.: 70-N-014000; MTR-CODE: AAF	<b>KT 1171 W1</b>

### 2.5 Syncro

2461 ccm	81 kW	AAF;ACU;AEN;AEU	10.92 - 04.03	ALT	FROM CHA-NO.: 70-N-000001; MTR-CODE: AAF; - AC	<b>6 PK 1718</b>
				ALT	FROM CHA-NO.: 70-N-000001; MTR-CODE: AAF; + AC	<b>6 PK 2130</b>
				ALT	FROM CHA-NO.: 70-N-000001; MTR-CODE: AAF; 2. ALT; 2 ALT	<b>6 PK 2000</b>
				ALT	FROM: 01.94; UNTIL: 01.95; MTR-CODE: ACU	<b>6 PK 2065</b>
				ALT	FROM: 01.94; UNTIL: 01.95; MTR-CODE: ACU; - AC	<b>6 PK 1718</b>
				ALT	FROM: 01.94; UNTIL: 01.95; MTR-CODE: ACU; 2. ALT; 2 ALT	<b>6 PK 2000</b>
				ALT	FROM: 01.95; MTR-CODE: ACU; + AUTO-TM; + AC	<b>6 PK 2228</b>
				ALT	FROM: 01.95; MTR-CODE: ACU; + MAN-TM; + AC	<b>6 PK 2240</b>
				ALT	FROM: 01.95; MTR-CODE: ACU; 2. ALT; 2 ALT	<b>6 PK 2075</b>
				ALT	FROM: 01.95; UNTIL: 01.96; MTR-CODE: ACU; - AC	<b>6 PK 1345</b>
				ALT	FROM: 01.96; MTR-CODE: ACU; - AC	<b>6 PK 1352</b>
				ALT	FROM: 05.96; MTR-CODE: AET;AEU;APL;AVT; - AC	<b>6 PK 1352</b>
				ALT	FROM: 05.96; MTR-CODE: AET;AEU;APL;AVT; + AUTO-TM; + AC	<b>6 PK 2228</b>
				ALT	FROM: 05.96; MTR-CODE: AET;AEU;APL;AVT; + MAN-TM; + AC	<b>6 PK 2240</b>
				ALT	FROM: 05.96; MTR-CODE: AET;AEU;APL;AVT; 2. ALT; 2 ALT	<b>6 PK 2075</b>
				HYD-P	FROM CHA-NO.: 70-N-000001; MTR-CODE: AAF	<b>6 PK 2065</b>
				HYD-P	FROM: 01.94; UNTIL: 01.95; MTR-CODE: ACU; + AC	<b>6 PK 2130</b>
				HYD-P	FROM: 01.95; MTR-CODE: ACU	<b>6 PK 2130</b>
				HYD-P	FROM: 05.96; MTR-CODE: AET;AEU;APL;AVT	<b>6 PK 2130</b>
				CAM	FROM CHA-NO.: 70-N-014001; MTR-CODE: AAF	<b>ZRK 1241</b>
				CAM	FROM MTR-NO: 019150; MTR-CODE: ACU	<b>ZRK 1301</b>
				CAM	MTR-CODE: AEN;AEU	<b>ZRK 1301</b>
				CAM	UNTIL MTR-NO: 019149; MTR-CODE: ACU	<b>ZRK 1241</b>
				CAM	FROM CHA-NO.: 70-N-014001; MTR-CODE: AAF	<b>KT 1402</b>
				CAM	FROM MTR-NO: 019150; UNTIL MTR-NO: 048994; MTR-CODE: ACU	<b>KT 1306</b>
				CAM	MTR-CODE: AEN	<b>KT 1306</b>
				CAM	UNTIL MTR-NO: 019149; MTR-CODE: ACU	<b>KT 1402</b>
				W-P; CAM	FROM MTR-NO: 019150; MTR-CODE: ACU	<b>KT 1306 W1</b>
				W-P; CAM	MTR-CODE: AEN;AEU	<b>KT 1306 W1</b>
				W-P; CAM	UNTIL CHA-NO.: 70-N-014000; MTR-CODE: AAF	<b>KT 1171 W1</b>

### 2.5

2461 ccm	85 kW	AET;APL;AVT	08.96 - 04.03	ALT	- AC	<b>6 PK 1352</b>
				ALT	+ AUTO-TM; + AC	<b>6 PK 2228</b>
				ALT	+ MAN-TM; + AC	<b>6 PK 2240</b>

**VW**
**TRANSPORTER T4 Pritsche/Fahrgestell (70XD)**
**2.5**

2461 ccm	85 kW	AET;APL;AVT	08.96 - 04.03	ALT HYD-P CAM W-P; CAM	2. ALT; 2 ALT	6 PK 2075 6 PK 2130 ZRK 1301 KT 1306 W1
----------	-------	-------------	---------------	---------------------------------	---------------	--

**2.5 Syncro**

2461 ccm	85 kW	AET;APL;AVT	08.96 - 04.03	ALT ALT ALT ALT HYD-P CAM W-P; CAM	- AC + AUTO-TM; + AC + MAN-TM; + AC 2. ALT; 2 ALT	6 PK 1352 6 PK 2228 6 PK 2240 6 PK 2075 6 PK 2130 ZRK 1301 KT 1306 W1
----------	-------	-------------	---------------	--	--	---

**2.8**

2792 ccm	103 kW	AES	05.96 - 05.00	ALT	+ AC	7 DPK 1400
----------	--------	-----	---------------	-----	------	------------

**2.8 VR6**

2792 ccm	150 kW	AMV	06.00 - 04.03	ALT ALT	- AC + AC	7 PK 1280 7 DPK 1360
----------	--------	-----	---------------	------------	--------------	-------------------------

**1.9 D**

1896 ccm	45 kW	1X	07.90 - 12.95	ALT PS ALT ALT CAM CAM CAM	UNTIL CHA-NO.: 70N200000 FROM CHA-NO.: 70-P-000001; - AMP: 120 FROM CHA-NO.: 70-P-000001; AMP: 120 FROM MTR-NO: 120078 UNTIL MTR-NO: 120077	AVX 10 x 975 AVX 11,9 x 650 6 PK 925 6 PK 1045 ZRK 1290 KT 1021 KT 1004
----------	-------	----	---------------	--	---	---

**1.9 TD**

1896 ccm	50 kW	ABL	10.92 - 04.03	ALT PS ALT ALT CAM CAM CAM	UNTIL CHA-NO.: 70N200000 FROM: 07.94; FROM CHA-NO.: 70-P-000001; - AMP: 120 FROM: 07.94; FROM CHA-NO.: 70-P-000001; AMP: 120 FROM MTR-NO: 029320 UNTIL MTR-NO: 029319	AVX 10 x 975 AVX 11,9 x 650 6 PK 925 6 PK 1045 ZRK 1290 KT 1021 KT 1004
----------	-------	-----	---------------	--	---	---

**2.4 D**

2370 ccm	55 kW	AJA	08.97 - 04.03	ALT ALT ALT ALT HYD-P HYD-P CAM INJ-P CAM W-P; CAM	- AC; - ENG-PTO + AC; - ENG-PTO + ENG-PTO 2. ALT; 2 ALT; + PTO FROM CHA-NO.: 70-X-140001; - ENG-PTO UNTIL CHA-NO.: 70-X-140000; - ENG-PTO	6 PK 1352 6 PK 2240 6 PK 1718 6 PK 2075 6 PK 2100 6 PK 2130 ZRK 1301 ZRK 1270 KT 1214 KT 1214 W1
----------	-------	-----	---------------	---	--	---

**2.4 D**

2370 ccm	57 kW	AAB	09.90 - 04.98	ALT ALT PS ALT ALT ALT ALT HYD-P CAM INJ-P CAM W-P; CAM W-P; CAM	UNTIL: 07.92 UNTIL: 07.92; + PTO UNTIL: 12.94 FROM CHA-NO.: 70-N-000001; - AC; - ENG-PTO FROM CHA-NO.: 70-N-000001; + AC; - ENG-PTO FROM CHA-NO.: 70-N-000001; + ENG-PTO FROM CHA-NO.: 70-N-000001; 2. ALT; 2 ALT; + PTO FROM CHA-NO.: 70-X-140001; - ENG-PTO FROM MTR-NO: 320127 UNTIL MTR-NO: 320126 FROM: 07.96; FROM MTR-NO: 320127 UNTIL: 06.96; UNTIL MTR-NO: 320126	AVX 10 x 1075 AVX 10 x 1150 AVX 10 x 864 6 PK 1352 6 PK 2240 6 PK 1718 6 PK 2075 6 PK 2100 ZRK 1301 ZRK 1270 KT 1214 KT 1171 KT 1214 W1 KT 1171 W1
----------	-------	-----	---------------	--	---	---

**2.4 D Syncro**

2370 ccm	57 kW	AAB	10.92 - 09.98	PS ALT	UNTIL: 12.94 FROM CHA-NO.: 70-N-000001; - AC; - ENG-PTO	AVX 10 x 864 6 PK 1352
----------	-------	-----	---------------	-----------	--	---------------------------

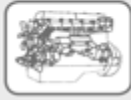

## VW

### TRANSPORTER T4 Pritsche/Fahrgestell (70XD)

#### 2.4 D Syncro

2370 ccm	57 kW	AAB	10.92 - 09.98	ALT	FROM CHA-NO.: 70-N-000001; + AC; - ENG-PTO	<b>6 PK 2240</b>
				ALT	FROM CHA-NO.: 70-N-000001; + ENG-PTO	<b>6 PK 1718</b>
				ALT	FROM CHA-NO.: 70-N-000001; 2. ALT; 2 ALT; + PTO	<b>6 PK 2075</b>
				HYD-P	FROM CHA-NO.: 70-X-140001; - ENG-PTO	<b>6 PK 2100</b>
				CAM		<b>ZRK 1301</b>
				INJ-P		<b>ZRK 1270</b>
				CAM	FROM MTR-NO: 320127	<b>KT 1214</b>
				CAM	UNTIL MTR-NO: 320126	<b>KT 1171</b>
				W-P; CAM	FROM: 07.96; FROM MTR-NO: 320127	<b>KT 1214 W1</b>
				W-P; CAM	UNTIL: 06.96; UNTIL MTR-NO: 320126	<b>KT 1171 W1</b>

#### 2.5 TDI

2461 ccm	65 kW	AJT;AYY	05.98 - 04.03	ALT	2. ALT; 2 ALT	<b>6 PK 2075</b>
				ALT	FROM CHA-NO.: 70-XX13365;XH132970; + AC	<b>6 PK 2215</b>
				ALT	FROM CHA-NO.: X-; + AUTO-TM; - AC	<b>6 PK 1751</b>
				ALT	FROM CHA-NO.: X-; + MAN-TM; - AC	<b>6 PK 1765</b>
				ALT	UNTIL CHA-NO.: 70-XX133656;XH132969; + AC	<b>6 PK 2240</b>
				CAM		<b>ZRK 1301</b>
				INJ-P		<b>ZRK 1238</b>
				CAM		<b>KT 1218</b>
				CAM		<b>KT 1302</b>
				CAM		<b>KT 1515</b>
				W-P; CAM		<b>KT 1218 W1</b>

#### 2.5 TDI

2461 ccm	75 kW	ACV;AUF;AYC	09.95 - 04.03	ALT	FROM CHA-NO.: 70-XX13365;XH132970; MTR-CODE: ACV;AHY;AJT;AUF; + AC	<b>6 PK 2215</b>
				ALT	FROM: 05.98; FROM CHA-NO.: X-; MTR-CODE: ACV;AHY;AJT;AUF; + AUTO-TM; - AC	<b>6 PK 1751</b>
				ALT	FROM: 05.98; FROM CHA-NO.: X-; MTR-CODE: ACV;AHY;AJT;AUF; + MAN-TM; - AC	<b>6 PK 1765</b>
				ALT	FROM: 09.00; MTR-CODE: AXG;AXG;AYC;AYY; - AC	<b>6 PK 1695</b>
				ALT	FROM: 09.00; MTR-CODE: AXG;AXG;AYC;AYY; + AC	<b>6 PK 2170</b>
				ALT	FROM: 09.00; MTR-CODE: AXG;AYC;AYY; OE-NO.: 074903137AS; 2. ALT; 2 ALT	<b>6 PK 2075</b>
				ALT	FROM: 09.00; MTR-CODE: AXG;AYC;AYY;AYY;AYC; - AC	<b>6 PK 1751</b>
				ALT	FROM: 09.00; MTR-CODE: AXG;AYC;AYY;AYY;AYC; + AC	<b>6 PK 2215</b>
				ALT	MTR-CODE: ACV;AHY;AJT;AUF; 2. ALT; 2 ALT	<b>6 PK 2075</b>
				ALT	UNTIL CHA-NO.: 70-XX133656;XH132969; MTR-CODE: ACV;AHY;AJT;AUF; + AC	<b>6 PK 2240</b>
				ALT	UNTIL: 04.98; UNTIL CHA-NO.: W-; MTR-CODE: ACV;AHY;AJT;AUF; - AC	<b>6 PK 1765</b>
				HYD-P	FROM: 09.00; MTR-CODE: AXG;AYC;AYY; OE-NO.: 074903137BB; 2. ALT; 2 ALT	<b>6 PK 2065</b>
				CAM		<b>ZRK 1301</b>
				INJ-P		<b>ZRK 1238</b>
				CAM		<b>KT 1214</b>
				CAM		<b>KT 1302</b>
				W-P; CAM		<b>KT 1214 W1</b>

#### 2.5 TDI Syncro

2461 ccm	75 kW	ACV;AXL	05.98 - 04.03	ALT	2. ALT; 2 ALT	<b>6 PK 2075</b>
				ALT	FROM CHA-NO.: 70-XX13365;XH132970; + AC	<b>6 PK 2215</b>
				ALT	FROM CHA-NO.: X-; + AUTO-TM; - AC	<b>6 PK 1751</b>
				ALT	FROM CHA-NO.: X-; + MAN-TM; - AC	<b>6 PK 1765</b>
				ALT	UNTIL CHA-NO.: 70-XX133656;XH132969; + AC	<b>6 PK 2240</b>
				CAM		<b>ZRK 1301</b>
				INJ-P		<b>ZRK 1238</b>
				CAM		<b>KT 1214</b>
				CAM		<b>KT 1302</b>
				CAM		<b>KT 1515</b>
				CAM	MTR-CODE: ACV	<b>KT 1442</b>
				W-P; CAM	MTR-CODE: ACV	<b>KT 1214 W1</b>
				W-P; CAM	MTR-CODE: AXL	<b>KT 1218 W1</b>

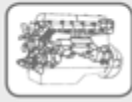
**VW**
**MULTIVAN T5 (7HM, 7HN, 7HF, 7EF, 7EM, 7EN)**
**2.0**

1984 ccm	85 kW	AXA	11.03 -	ALT	- AC	6 PK 1125
				ALT	+ AC	6 DPK 1195
				CAM		ZRK 1216
				CAM		KT 1133

**2.0 TSI**

1984 ccm	150 kW	CJKA	05.11 -	W-P		ZRK 1585
----------	--------	------	---------	-----	--	----------

**2.0 TSI 4motion**

1984 ccm	150 kW	CJKA	07.11 -	W-P		ZRK 1585
----------	--------	------	---------	-----	--	----------

**3.2 V6**

3189 ccm	170 kW	BDL	02.04 -	ALT	- AC	6 PK 1265
				ALT	+ AC	6 DPK 1320

**3.2 V6**

3189 ccm	173 kW	BKK;CFLA	02.04 -	ALT	- AC	6 PK 1265
				ALT	+ AC	6 DPK 1320

**3.2 V6 4motion**

3189 ccm	173 kW	BKK;CFLA	07.04 -	ALT	- AC	6 PK 1265
				ALT	+ AC	6 DPK 1320

**1.9 TDI**

1896 ccm	62 kW	BRR	01.06 -	ALT	FROM CHA-NO.: 7H-6H079891; - AC	6 PK 1138
				ALT	FROM CHA-NO.: 7H-6H079891; + AC	6 DPK 1215
				ALT	FROM CHA-NO.: 7H-6X022357; - AC	6 PK 1138
				ALT	FROM CHA-NO.: 7H-6X022357; + AC	6 DPK 1215
				ALT	UNTIL CHA-NO.: 7H-6H079890; - AC	6 PK 1125
				ALT	UNTIL CHA-NO.: 7H-6H079890; + AC	6 DPK 1195
				ALT	UNTIL CHA-NO.: 7H-6X022356; - AC	6 PK 1125
				ALT	UNTIL CHA-NO.: 7H-6X022356; + AC	6 DPK 1195
				CAM		ZRK 1338
				CAM		KT 1237
				CAM		KT 1237 W2

**1.9 TDI**

1896 ccm	75 kW	BRS	06.06 -	ALT	FROM CHA-NO.: 7H-6H079891; - AC	6 PK 1138
				ALT	FROM CHA-NO.: 7H-6H079891; + AC	6 DPK 1215
				ALT	FROM CHA-NO.: 7H-6X022357; - AC	6 PK 1138
				ALT	FROM CHA-NO.: 7H-6X022357; + AC	6 DPK 1215
				ALT	UNTIL CHA-NO.: 7H-6H079890; - AC	6 PK 1125
				ALT	UNTIL CHA-NO.: 7H-6H079890; + AC	6 DPK 1195
				ALT	UNTIL CHA-NO.: 7H-6X022356; - AC	6 PK 1125
				ALT	UNTIL CHA-NO.: 7H-6X022356; + AC	6 DPK 1195
				W-P; CAM		ZRK 1338
				W-P; CAM		KT 1237
				W-P; CAM		KT 1237 W2

**1.9 TDI**

1896 ccm	77 kW	AXB	04.03 -	ALT	FROM CHA-NO.: 7H-6H079891; - AC	6 PK 1138
				ALT	FROM CHA-NO.: 7H-6H079891; + AC	6 DPK 1215
				ALT	FROM CHA-NO.: 7H-6X022357; - AC	6 PK 1138
				ALT	FROM CHA-NO.: 7H-6X022357; + AC	6 DPK 1215
				ALT	UNTIL CHA-NO.: 7H-6H079890; - AC	6 PK 1125
				ALT	UNTIL CHA-NO.: 7H-6H079890; + AC	6 DPK 1195
				ALT	UNTIL CHA-NO.: 7H-6X022356; - AC	6 PK 1125
				ALT	UNTIL CHA-NO.: 7H-6X022356; + AC	6 DPK 1195
				W-P; CAM		ZRK 1338
				W-P; CAM		KT 1237
				W-P; CAM		KT 1237 W2

**2.0 TDI**

1968 ccm	62 kW	CAAA	09.09 -	ALT	- AC	6 PK 1078
				ALT	+ AC	6 PK 1555
				CAM	MTR-CODE: CAAA;CAAB;CAAC;CAAE;CCHA;CCHB;CFCA	ZRK 1572

**2.0 TDI**

1968 ccm	75 kW	CAAB	09.09 -	ALT	- AC	6 PK 1078
				ALT	+ AC	6 PK 1555
				CAM	MTR-CODE: CAAA;CAAB;CAAC;CAAE;CCHA;CCHB;CFCA	ZRK 1572

**2.0 TDI**

1968 ccm	84 kW	CAAD	05.11 -	CAM		ZRK 1572
----------	-------	------	---------	-----	--	----------



## VW

### MULTIVAN T5 (7HM, 7HN, 7HF, 7EF, 7EM, 7EN)

#### 2.0 TDI

1968 ccm	103 kW	CAAC;CCHA	09.09 -	ALT	- AC	<b>6 PK 1078</b>
				ALT	+ AC	<b>6 PK 1555</b>
				CAM	MTR-CODE: CAAA;CAAB;CAAC;CAAE;CCHA;CCHB;CFCA	<b>ZRK 1572</b>

#### 2.0 TDI 4motion

1968 ccm	103 kW	CAAC;CCHA	09.09 -	ALT	- AC	<b>6 PK 1078</b>
				ALT	+ AC	<b>6 PK 1555</b>
				CAM	MTR-CODE: CAAA;CAAB;CAAC;CAAE;CCHA;CCHB;CFCA	<b>ZRK 1572</b>

#### 2.0 BiTDI

1968 ccm	132 kW	CFCA	09.09 -	ALT	- AC	<b>6 PK 1078</b>
				ALT	+ AC	<b>6 PK 1555</b>
				CAM	MTR-CODE: CAAA;CAAB;CAAC;CAAE;CCHA;CCHB;CFCA	<b>ZRK 1572</b>

#### 2.0 BiTDI 4motion

1968 ccm	132 kW	CFCA	09.09 -	ALT	- AC	<b>6 PK 1078</b>
				ALT	+ AC	<b>6 PK 1555</b>
				CAM	MTR-CODE: CAAA;CAAB;CAAC;CAAE;CCHA;CCHB;CFCA	<b>ZRK 1572</b>

### TRANSPORTER T5 Bus (7HB, 7HJ, 7EB, 7EJ, 7EF)

#### 2.0

1984 ccm	85 kW	AXA	11.03 -	ALT	- AC	<b>6 PK 1125</b>
				ALT	+ AC	<b>6 DPK 1195</b>
				ALT	FROM: 09.09; - AC	<b>6 PK 1125</b>
				ALT	FROM: 09.09; + AC	<b>6 DPK 1195</b>
				ALT	MOD: Shuttle/Eurovan; - AC	<b>6 PK 1125</b>
				ALT	MOD: Shuttle/Eurovan; + AC	<b>6 DPK 1195</b>
				CAM		<b>ZRK 1216</b>
				CAM		<b>KT 1133</b>

#### 2.0 TSI

1984 ccm	150 kW	CJKA	05.11 -	W-P		<b>ZRK 1585</b>
----------	--------	------	---------	-----	--	-----------------

#### 2.0 TSI 4motion

1984 ccm	150 kW	CJKA	07.11 -	W-P		<b>ZRK 1585</b>
----------	--------	------	---------	-----	--	-----------------

#### 3.2 V6

3189 ccm	170 kW	BDL	02.04 -	ALT	- AC	<b>6 PK 1265</b>
				ALT	+ AC	<b>6 DPK 1320</b>
				ALT	MOD: Shuttle/Eurovan; - AC	<b>6 PK 1265</b>
				ALT	MOD: Shuttle/Eurovan; + AC	<b>6 DPK 1320</b>

#### 3.2 V6

3189 ccm	173 kW	BKK;CFLA	02.04 -	ALT	MOD: Shuttle/Eurovan; - AC	<b>6 PK 1265</b>
				ALT	MOD: Shuttle/Eurovan; + AC	<b>6 DPK 1320</b>

#### 3.2 V6 4motion

3189 ccm	173 kW	BKK;CFLA	11.03 -	ALT	FROM: 05.08; MTR-CODE: BKK; - AC	<b>6 PK 1265</b>
				ALT	FROM: 05.08; MTR-CODE: BKK; + AC	<b>6 DPK 1320</b>
				ALT	MTR-CODE: BKK; MOD: Shuttle/Eurovan; - AC	<b>6 PK 1265</b>
				ALT	MTR-CODE: BKK; MOD: Shuttle/Eurovan; + AC	<b>6 DPK 1320</b>

#### 1.9 TDI

1896 ccm	62 kW	BRR	01.06 -	ALT	FROM CHA-NO.: 7H-6H079891; MTR-CODE: AXB;AXC;BRR;BRS; - AC	<b>6 PK 1138</b>
				ALT	FROM CHA-NO.: 7H-6H079891; MTR-CODE: AXB;AXC;BRR;BRS; + AC	<b>6 DPK 1215</b>
				ALT	FROM CHA-NO.: 7H-6X022357; MTR-CODE: AXB;AXC;BRR;BRS; - AC	<b>6 PK 1138</b>
				ALT	FROM CHA-NO.: 7H-6X022357; MTR-CODE: AXB;AXC;BRR;BRS; + AC	<b>6 DPK 1215</b>
				ALT	FROM: 06.06; FROM CHA-NO.: 7H-6H079891; MTR-CODE: BRR; - AC	<b>6 PK 1138</b>
				ALT	FROM: 06.06; FROM CHA-NO.: 7H-6H079891; MTR-CODE: BRR; + AC	<b>6 DPK 1215</b>
				ALT	FROM: 06.06; FROM CHA-NO.: 7H-6X022357; MTR-CODE: BRR; - AC	<b>6 PK 1138</b>
				ALT	FROM: 06.06; FROM CHA-NO.: 7H-6X022357; MTR-CODE: BRR; + AC	<b>6 DPK 1215</b>
				ALT	FROM: 06.06; UNTIL CHA-NO.: 7H-6H079890; MTR-CODE: BRR; - AC	<b>6 PK 1125</b>
				ALT	FROM: 06.06; UNTIL CHA-NO.: 7H-6H079890; MTR-CODE: BRR; + AC	<b>6 DPK 1195</b>

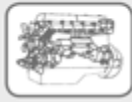
**VW**
**TRANSPORTER T5 Bus (7HB, 7HJ, 7EB, 7EJ, 7EF)**

<b>1.9 TDI</b>						
1896 ccm	62 kW	BRR	01.06 -	ALT	FROM: 06.06; UNTIL CHA-NO.: 7H-6X022356; MTR-CODE: BRR; - AC	<b>6 PK 1125</b>
				ALT	FROM: 06.06; UNTIL CHA-NO.: 7H-6X022356; MTR-CODE: BRR; + AC	<b>6 DPK 1195</b>
				ALT	UNTIL CHA-NO.: 7H-6H079890; MTR-CODE: AXB;AXC;BRR;BRS; - AC	<b>6 PK 1125</b>
				ALT	UNTIL CHA-NO.: 7H-6H079890; MTR-CODE: AXB;AXC;BRR;BRS; + AC	<b>6 DPK 1195</b>
				ALT	UNTIL CHA-NO.: 7H-6X022356; MTR-CODE: AXB;AXC;BRR;BRS; - AC	<b>6 PK 1125</b>
				ALT	UNTIL CHA-NO.: 7H-6X022356; MTR-CODE: AXB;AXC;BRR;BRS; + AC	<b>6 DPK 1195</b>
				W-P; CAM		<b>ZRK 1338</b>
				W-P; CAM		<b>KT 1237</b>
				W-P; CAM		<b>KT 1237 W2</b>

<b>1.9 TDI</b>						
1896 ccm	63 kW	AXC	04.03 -	ALT	FROM CHA-NO.: 7H-6H079891; MTR-CODE: AXB;AXC; MOD: Shuttle/Eurovan; - AC	<b>6 PK 1138</b>
				ALT	FROM CHA-NO.: 7H-6H079891; MTR-CODE: AXB;AXC; MOD: Shuttle/Eurovan; + AC	<b>6 DPK 1215</b>
				ALT	FROM CHA-NO.: 7H-6H079891; MTR-CODE: AXB;AXC;BRR;BRS; - AC	<b>6 PK 1138</b>
				ALT	FROM CHA-NO.: 7H-6H079891; MTR-CODE: AXB;AXC;BRR;BRS; + AC	<b>6 DPK 1215</b>
				ALT	FROM CHA-NO.: 7H-6H079891; MTR-CODE: AXC; - AC	<b>6 PK 1138</b>
				ALT	FROM CHA-NO.: 7H-6H079891; MTR-CODE: AXC; + AC	<b>6 DPK 1215</b>
				ALT	FROM CHA-NO.: 7H-6X022357; MTR-CODE: AXB;AXC; MOD: Shuttle/Eurovan; - AC	<b>6 PK 1138</b>
				ALT	FROM CHA-NO.: 7H-6X022357; MTR-CODE: AXB;AXC; MOD: Shuttle/Eurovan; + AC	<b>6 DPK 1215</b>
				ALT	FROM CHA-NO.: 7H-6X022357; MTR-CODE: AXB;AXC;BRR;BRS; - AC	<b>6 PK 1138</b>
				ALT	FROM CHA-NO.: 7H-6X022357; MTR-CODE: AXB;AXC;BRR;BRS; + AC	<b>6 DPK 1215</b>
				ALT	FROM CHA-NO.: 7H-6X022357; MTR-CODE: AXC; - AC	<b>6 PK 1138</b>
				ALT	FROM CHA-NO.: 7H-6X022357; MTR-CODE: AXC; + AC	<b>6 DPK 1215</b>
				ALT	UNTIL CHA-NO.: 7H-6H079890; MTR-CODE: AXB;AXC; MOD: Shuttle/Eurovan; - AC	<b>6 PK 1125</b>
				ALT	UNTIL CHA-NO.: 7H-6H079890; MTR-CODE: AXB;AXC; MOD: Shuttle/Eurovan; + AC	<b>6 DPK 1195</b>
				ALT	UNTIL CHA-NO.: 7H-6H079890; MTR-CODE: AXB;AXC;BRR;BRS; - AC	<b>6 PK 1125</b>
				ALT	UNTIL CHA-NO.: 7H-6H079890; MTR-CODE: AXB;AXC;BRR;BRS; + AC	<b>6 DPK 1195</b>
				ALT	UNTIL CHA-NO.: 7H-6H079890; MTR-CODE: AXC; - AC	<b>6 PK 1125</b>
				ALT	UNTIL CHA-NO.: 7H-6H079890; MTR-CODE: AXC; + AC	<b>6 DPK 1195</b>
				ALT	UNTIL CHA-NO.: 7H-6X022356; MTR-CODE: AXB;AXC; MOD: Shuttle/Eurovan; - AC	<b>6 PK 1125</b>
				ALT	UNTIL CHA-NO.: 7H-6X022356; MTR-CODE: AXB;AXC; MOD: Shuttle/Eurovan; + AC	<b>6 DPK 1195</b>
				ALT	UNTIL CHA-NO.: 7H-6X022356; MTR-CODE: AXB;AXC;BRR;BRS; - AC	<b>6 PK 1125</b>
				ALT	UNTIL CHA-NO.: 7H-6X022356; MTR-CODE: AXB;AXC;BRR;BRS; + AC	<b>6 DPK 1195</b>
				ALT	UNTIL CHA-NO.: 7H-6X022356; MTR-CODE: AXC; - AC	<b>6 PK 1125</b>
				ALT	UNTIL CHA-NO.: 7H-6X022356; MTR-CODE: AXC; + AC	<b>6 DPK 1195</b>
				W-P; CAM		<b>ZRK 1338</b>
				W-P; CAM		<b>KT 1237</b>
				W-P; CAM		<b>KT 1237 W2</b>

<b>1.9 TDI</b>						
1896 ccm	75 kW	BRS	06.06 -	ALT	FROM CHA-NO.: 7H-6H079891; MTR-CODE: AXB;AXC;BRR;BRS; - AC	<b>6 PK 1138</b>
				ALT	FROM CHA-NO.: 7H-6H079891; MTR-CODE: AXB;AXC;BRR;BRS; + AC	<b>6 DPK 1215</b>



## VW

### TRANSPORTER T5 Bus (7HB, 7HJ, 7EB, 7EJ, 7EF)

#### 1.9 TDI

1896 ccm	75 kW	BRS	06.06 -	ALT	FROM CHA-NO.: 7H-6H079891; MTR-CODE: BRS; - AC	<b>6 PK 1138</b>
				ALT	FROM CHA-NO.: 7H-6H079891; MTR-CODE: BRS; + AC	<b>6 DPK 1215</b>
				ALT	FROM CHA-NO.: 7H-6X022357; MTR-CODE: AXB;AXC;BRR;BRS; - AC	<b>6 PK 1138</b>
				ALT	FROM CHA-NO.: 7H-6X022357; MTR-CODE: AXB;AXC;BRR;BRS; + AC	<b>6 DPK 1215</b>
				ALT	FROM CHA-NO.: 7H-6X022357; MTR-CODE: BRS; - AC	<b>6 PK 1138</b>
				ALT	FROM CHA-NO.: 7H-6X022357; MTR-CODE: BRS; + AC	<b>6 DPK 1215</b>
				ALT	UNTIL CHA-NO.: 7H-6H079890; MTR-CODE: AXB;AXC;BRR;BRS; - AC	<b>6 PK 1125</b>
				ALT	UNTIL CHA-NO.: 7H-6H079890; MTR-CODE: AXB;AXC;BRR;BRS; + AC	<b>6 DPK 1195</b>
				ALT	UNTIL CHA-NO.: 7H-6H079890; MTR-CODE: BRS; - AC	<b>6 PK 1125</b>
				ALT	UNTIL CHA-NO.: 7H-6H079890; MTR-CODE: BRS; + AC	<b>6 DPK 1195</b>
				ALT	UNTIL CHA-NO.: 7H-6X022356; MTR-CODE: AXB;AXC;BRR;BRS; - AC	<b>6 PK 1125</b>
				ALT	UNTIL CHA-NO.: 7H-6X022356; MTR-CODE: AXB;AXC;BRR;BRS; + AC	<b>6 DPK 1195</b>
				ALT	UNTIL CHA-NO.: 7H-6X022356; MTR-CODE: BRS; - AC	<b>6 PK 1125</b>
				ALT	UNTIL CHA-NO.: 7H-6X022356; MTR-CODE: BRS; + AC	<b>6 DPK 1195</b>
				W-P; CAM		<b>ZRK 1338</b>
				W-P; CAM		<b>KT 1237</b>
				W-P; CAM		<b>KT 1237 W2</b>

#### 1.9 TDI

1896 ccm	77 kW	AXB	04.03 -	ALT	FROM CHA-NO.: 7H-6H079891; MTR-CODE: AXB;AXC; MOD: Shuttle/Eurovan; - AC	<b>6 PK 1138</b>
				ALT	FROM CHA-NO.: 7H-6H079891; MTR-CODE: AXB;AXC; MOD: Shuttle/Eurovan; + AC	<b>6 DPK 1215</b>
				ALT	FROM CHA-NO.: 7H-6H079891; MTR-CODE: AXB;AXC;BRR;BRS; - AC	<b>6 PK 1138</b>
				ALT	FROM CHA-NO.: 7H-6H079891; MTR-CODE: AXB;AXC;BRR;BRS; + AC	<b>6 DPK 1215</b>
				ALT	FROM CHA-NO.: 7H-6X022357; MTR-CODE: AXB;AXC; MOD: Shuttle/Eurovan; - AC	<b>6 PK 1138</b>
				ALT	FROM CHA-NO.: 7H-6X022357; MTR-CODE: AXB;AXC; MOD: Shuttle/Eurovan; + AC	<b>6 DPK 1215</b>
				ALT	FROM CHA-NO.: 7H-6X022357; MTR-CODE: AXB;AXC;BRR;BRS; - AC	<b>6 PK 1138</b>
				ALT	FROM CHA-NO.: 7H-6X022357; MTR-CODE: AXB;AXC;BRR;BRS; + AC	<b>6 DPK 1215</b>
				ALT	FROM: 05.08; MTR-CODE: AXB; - AC	<b>6 PK 1138</b>
				ALT	FROM: 05.08; MTR-CODE: AXB; + AC	<b>6 DPK 1215</b>
				ALT	UNTIL CHA-NO.: 7H-6H079890; MTR-CODE: AXB;AXC; MOD: Shuttle/Eurovan; - AC	<b>6 PK 1125</b>
				ALT	UNTIL CHA-NO.: 7H-6H079890; MTR-CODE: AXB;AXC; MOD: Shuttle/Eurovan; + AC	<b>6 DPK 1195</b>
				ALT	UNTIL CHA-NO.: 7H-6H079890; MTR-CODE: AXB;AXC;BRR;BRS; - AC	<b>6 PK 1125</b>
				ALT	UNTIL CHA-NO.: 7H-6H079890; MTR-CODE: AXB;AXC;BRR;BRS; + AC	<b>6 DPK 1195</b>
				ALT	UNTIL CHA-NO.: 7H-6X022356; MTR-CODE: AXB;AXC; MOD: Shuttle/Eurovan; - AC	<b>6 PK 1125</b>
				ALT	UNTIL CHA-NO.: 7H-6X022356; MTR-CODE: AXB;AXC; MOD: Shuttle/Eurovan; + AC	<b>6 DPK 1195</b>
				ALT	UNTIL CHA-NO.: 7H-6X022356; MTR-CODE: AXB;AXC;BRR;BRS; - AC	<b>6 PK 1125</b>
				ALT	UNTIL CHA-NO.: 7H-6X022356; MTR-CODE: AXB;AXC;BRR;BRS; + AC	<b>6 DPK 1195</b>
				W-P; CAM		<b>ZRK 1338</b>
				W-P; CAM		<b>KT 1237</b>
				W-P; CAM		<b>KT 1237 W2</b>

#### 2.0 TDI

1968 ccm	62 kW	CAAA	09.09 -	ALT	MTR-CODE: CAAA; - AC	<b>6 PK 1078</b>
				ALT	MTR-CODE: CAAA; + AC	<b>6 PK 1555</b>
				ALT	MTR-CODE: CAAA;CAAB;CAAC; - AC	<b>6 PK 1078</b>



**VW**
**TRANSPORTER T5 Bus (7HB, 7HJ, 7EB, 7EJ, 7EF)**

<b>2.0 TDI</b>							
1968 ccm	62 kW	CAAA	09.09 -	ALT	MTR-CODE: CAAA;CAAB;CAAC; + AC	6 PK 1555	
				CAM	MTR-CODE: CAAA;CAAB;CAAC;CAAE;CCHA;CCHB;CFCA	ZRK 1572	
<b>2.0 TDI</b>							
1968 ccm	75 kW	CAAB	09.09 -	ALT	MTR-CODE: CAAA;CAAB;CAAC; - AC	6 PK 1078	
				ALT	MTR-CODE: CAAA;CAAB;CAAC; + AC	6 PK 1555	
				ALT	MTR-CODE: CAAB; - AC	6 PK 1078	
				ALT	MTR-CODE: CAAB; + AC	6 PK 1555	
				CAM	MTR-CODE: CAAA;CAAB;CAAC;CAAE;CCHA;CCHB;CFCA	ZRK 1572	
<b>2.0 TDI</b>							
1968 ccm	84 kW	CAAD	05.11 -	CAM		ZRK 1572	
<b>2.0 TDI</b>							
1968 ccm	103 kW	CAAC;CCHA	09.09 -	ALT	MTR-CODE: CAAA;CAAB;CAAC; - AC	6 PK 1078	
				ALT	MTR-CODE: CAAA;CAAB;CAAC; + AC	6 PK 1555	
				ALT	MTR-CODE: CAAC;CCHA; - AC	6 PK 1078	
				ALT	MTR-CODE: CAAC;CCHA; + AC	6 PK 1555	
				ALT	MTR-CODE: CCHA;CFCA; - AC	6 PK 1078	
				ALT	MTR-CODE: CCHA;CFCA; + AC	6 PK 1555	
				CAM	MTR-CODE: CAAA;CAAB;CAAC;CAAE;CCHA;CCHB;CFCA	ZRK 1572	
<b>2.0 TDI 4motion</b>							
1968 ccm	103 kW	CAAC;CCHA	09.09 -	ALT	MTR-CODE: CAAA;CAAB;CAAC; - AC	6 PK 1078	
				ALT	MTR-CODE: CAAA;CAAB;CAAC; + AC	6 PK 1555	
				ALT	MTR-CODE: CAAC;CCHA; - AC	6 PK 1078	
				ALT	MTR-CODE: CAAC;CCHA; + AC	6 PK 1555	
				ALT	MTR-CODE: CCHA;CFCA; - AC	6 PK 1078	
				ALT	MTR-CODE: CCHA;CFCA; + AC	6 PK 1555	
				CAM	MTR-CODE: CAAA;CAAB;CAAC;CAAE;CCHA;CCHB;CFCA	ZRK 1572	
<b>2.0 BitDI</b>							
1968 ccm	132 kW	CFCA	09.09 -	ALT	MTR-CODE: CCHA;CFCA; - AC	6 PK 1078	
				ALT	MTR-CODE: CCHA;CFCA; + AC	6 PK 1555	
				ALT	MTR-CODE: CFCA; - AC	6 PK 1078	
				ALT	MTR-CODE: CFCA; + AC	6 PK 1555	
				CAM	MTR-CODE: CAAA;CAAB;CAAC;CAAE;CCHA;CCHB;CFCA	ZRK 1572	
<b>2.0 BitDI 4motion</b>							
1968 ccm	132 kW	CFCA	09.09 -	ALT	MTR-CODE: CCHA;CFCA; - AC	6 PK 1078	
				ALT	MTR-CODE: CCHA;CFCA; + AC	6 PK 1555	
				ALT	MTR-CODE: CFCA; - AC	6 PK 1078	
				ALT	MTR-CODE: CFCA; + AC	6 PK 1555	
				CAM	MTR-CODE: CAAA;CAAB;CAAC;CAAE;CCHA;CCHB;CFCA	ZRK 1572	

**TRANSPORTER T5 Kasten (7HA, 7HH, 7EA, 7EH)**

<b>2.0</b>							
1984 ccm	85 kW	AXA	11.03 -	ALT	- AC	6 PK 1125	
				ALT	+ AC	6 DPK 1195	
				CAM		ZRK 1216	
				CAM		KT 1133	
<b>2.0 TSI</b>							
1984 ccm	150 kW	CJKA	05.11 -	W-P		ZRK 1585	
<b>2.0 TSI 4motion</b>							
1984 ccm	150 kW	CJKA	07.11 -	W-P		ZRK 1585	
<b>3.2 V6</b>							
3189 ccm	170 kW	BDL	04.03 -	ALT	FROM: 11.03; - AC	6 PK 1265	
				ALT	FROM: 11.03; + AC	6 DPK 1320	
<b>3.2 V6</b>							
3189 ccm	173 kW	BKK;CFLA	02.04 -	ALT	- AC	6 PK 1265	
				ALT	+ AC	6 DPK 1320	
<b>3.2 4motion</b>							
3189 ccm	173 kW	BKK;CFLA	11.03 -	ALT	- AC	6 PK 1265	
				ALT	+ AC	6 DPK 1320	
<b>1.9 TDI</b>							
1896 ccm	62 kW	BRR	01.06 -	ALT	FROM CHA-NO.: 7H-6H079891; - AC	6 PK 1138	
				ALT	FROM CHA-NO.: 7H-6H079891; + AC	6 DPK 1215	

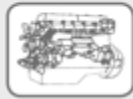



## VW

### TRANSPORTER T5 Kasten (7HA, 7HH, 7EA, 7EH)

#### 1.9 TDI

1896 ccm	62 kW	BRR	01.06 -	ALT	FROM CHA-NO.: 7H-6X022357; - AC	6 PK 1138
				ALT	FROM CHA-NO.: 7H-6X022357; + AC	6 DPK 1215
				ALT	UNTIL CHA-NO.: 7H-6H079890; - AC	6 PK 1125
				ALT	UNTIL CHA-NO.: 7H-6H079890; + AC	6 DPK 1195
				ALT	UNTIL CHA-NO.: 7H-6X022356; - AC	6 PK 1125
				ALT	UNTIL CHA-NO.: 7H-6X022356; + AC	6 DPK 1195
				W-P; CAM		ZRK 1338
				W-P; CAM		KT 1237
				W-P; CAM		KT 1237 W2

#### 1.9 TDI

1896 ccm	63 kW	AXC	04.03 -	ALT	FROM CHA-NO.: 7H-6H079891; - AC	6 PK 1138
				ALT	FROM CHA-NO.: 7H-6H079891; + AC	6 DPK 1215
				ALT	FROM CHA-NO.: 7H-6X022357; - AC	6 PK 1138
				ALT	FROM CHA-NO.: 7H-6X022357; + AC	6 DPK 1215
				ALT	UNTIL CHA-NO.: 7H-6H079890; - AC	6 PK 1125
				ALT	UNTIL CHA-NO.: 7H-6H079890; + AC	6 DPK 1195
				ALT	UNTIL CHA-NO.: 7H-6X022356; - AC	6 PK 1125
				ALT	UNTIL CHA-NO.: 7H-6X022356; + AC	6 DPK 1195
				W-P; CAM		ZRK 1338
				W-P; CAM		KT 1237
				W-P; CAM		KT 1237 W2

#### 1.9 TDI

1896 ccm	75 kW	BRS	06.06 -	ALT	FROM CHA-NO.: 7H-6H079891; - AC	6 PK 1138
				ALT	FROM CHA-NO.: 7H-6H079891; + AC	6 DPK 1215
				ALT	FROM CHA-NO.: 7H-6X022357; - AC	6 PK 1138
				ALT	FROM CHA-NO.: 7H-6X022357; + AC	6 DPK 1215
				ALT	UNTIL CHA-NO.: 7H-6H079890; - AC	6 PK 1125
				ALT	UNTIL CHA-NO.: 7H-6H079890; + AC	6 DPK 1195
				ALT	UNTIL CHA-NO.: 7H-6X022356; - AC	6 PK 1125
				ALT	UNTIL CHA-NO.: 7H-6X022356; + AC	6 DPK 1195
				W-P; CAM		ZRK 1338
				W-P; CAM		KT 1237
				W-P; CAM		KT 1237 W2

#### 1.9 TDI

1896 ccm	77 kW	AXB	04.03 -	ALT	FROM CHA-NO.: 7H-6H079891; - AC	6 PK 1138
				ALT	FROM CHA-NO.: 7H-6H079891; + AC	6 DPK 1215
				ALT	FROM CHA-NO.: 7H-6X022357; - AC	6 PK 1138
				ALT	FROM CHA-NO.: 7H-6X022357; + AC	6 DPK 1215
				ALT	UNTIL CHA-NO.: 7H-6H079890; - AC	6 PK 1125
				ALT	UNTIL CHA-NO.: 7H-6H079890; + AC	6 DPK 1195
				ALT	UNTIL CHA-NO.: 7H-6X022356; - AC	6 PK 1125
				ALT	UNTIL CHA-NO.: 7H-6X022356; + AC	6 DPK 1195
				W-P; CAM		ZRK 1338
				W-P; CAM		KT 1237
				W-P; CAM		KT 1237 W2

#### 2.0 TDI

1968 ccm	62 kW	CAAA	09.09 -	ALT	- AC	6 PK 1078
				ALT	+ AC	6 PK 1555
				CAM	MTR-CODE: CAAA;CAAB;CAAC;CAAE;CCHA;CCHB;CFCA	ZRK 1572

#### 2.0 TDI

1968 ccm	75 kW	CAAB	09.09 -	ALT	- AC	6 PK 1078
				ALT	+ AC	6 PK 1555
				CAM	MTR-CODE: CAAA;CAAB;CAAC;CAAE;CCHA;CCHB;CFCA	ZRK 1572

#### 2.0 TDI

1968 ccm	84 kW	CAAD	05.11 -	CAM		ZRK 1572
----------	-------	------	---------	-----	--	----------

#### 2.0 TDI

1968 ccm	103 kW	CAAC;CCHA	09.09 -	ALT	MTR-CODE: CAAA;CAAB;CAAC; - AC	6 PK 1078
				ALT	MTR-CODE: CAAA;CAAB;CAAC; + AC	6 PK 1555
				ALT	MTR-CODE: CCHA;CFCA; - AC	6 PK 1078
				ALT	MTR-CODE: CCHA;CFCA; + AC	6 PK 1555
				CAM	MTR-CODE: CAAA;CAAB;CAAC;CAAE;CCHA;CCHB;CFCA	ZRK 1572

#### 2.0 TDI 4motion

1968 ccm	103 kW	CAAC;CCHA	09.09 -	ALT	MTR-CODE: CAAA;CAAB;CAAC; - AC	6 PK 1078
----------	--------	-----------	---------	-----	--------------------------------	-----------

**VW**
**TRANSPORTER T5 Kasten (7HA, 7HH, 7EA, 7EH)**
**2.0 TDI 4motion**

1968 ccm	103 kW	CAAC;CCHA	09.09 -	ALT	MTR-CODE: CAAA;CAAB;CAAC; + AC	6 PK 1555
				ALT	MTR-CODE: CCHA;CFCA; - AC	6 PK 1078
				ALT	MTR-CODE: CCHA;CFCA; + AC	6 PK 1555
				CAM	MTR-CODE: CAAA;CAAB;CAAC;CAAE;CCHA;CCHB;OFCA	ZRK 1572

**2.0 BITDI**

1968 ccm	132 kW	CFCA	09.09 -	ALT	- AC	6 PK 1078
				ALT	+ AC	6 PK 1555
				CAM	MTR-CODE: CAAA;CAAB;CAAC;CAAE;CCHA;CCHB;CFCA	ZRK 1572

**2.0 BiTDI 4motion**

1968 ccm	132 kW	CFCA	09.09 -	ALT	- AC	6 PK 1078
				ALT	+ AC	6 PK 1555
				CAM	MTR-CODE: CAAA;CAAB;CAAC;CAAE;CCHA;CCHB;CFCA	ZRK 1572

**TRANSPORTER T5 Pritsche/Fahrgestell (7JD, 7JE, 7JL, 7JY, 7JZ)**
**2.0**

1984 ccm	85 kW	AXA	11.03 -	ALT	- AC	6 PK 1125
				ALT	+ AC	6 DPK 1195
				CAM		ZRK 1216
				CAM		KT 1133

**3.2 V6**

3189 ccm	170 kW	BDL	02.04 -	ALT	- AC	6 PK 1265
				ALT	+ AC	6 DPK 1320

**1.9 TDI**

1896 ccm	62 kW	BRR	01.06 -	ALT	FROM CHA-NO.: 7H-6H079891; - AC	6 PK 1138
				ALT	FROM CHA-NO.: 7H-6H079891; + AC	6 DPK 1215
				ALT	FROM CHA-NO.: 7H-6X022357; - AC	6 PK 1138
				ALT	FROM CHA-NO.: 7H-6X022357; + AC	6 DPK 1215
				ALT	UNTIL CHA-NO.: 7H-6H079890; - AC	6 PK 1125
				ALT	UNTIL CHA-NO.: 7H-6H079890; + AC	6 DPK 1195
				ALT	UNTIL CHA-NO.: 7H-6X022356; - AC	6 PK 1125
				ALT	UNTIL CHA-NO.: 7H-6X022356; + AC	6 DPK 1195
				W-P; CAM		ZRK 1338
				W-P; CAM		KT 1237
				W-P; CAM		KT 1237 W2

**1.9 TDI**

1896 ccm	63 kW	AXC	04.03 -	ALT	FROM CHA-NO.: 7H-6H079891; - AC	6 PK 1138
				ALT	FROM CHA-NO.: 7H-6H079891; + AC	6 DPK 1215
				ALT	FROM CHA-NO.: 7H-6X022357; - AC	6 PK 1138
				ALT	FROM CHA-NO.: 7H-6X022357; + AC	6 DPK 1215
				ALT	UNTIL CHA-NO.: 7H-6H079890; - AC	6 PK 1125
				ALT	UNTIL CHA-NO.: 7H-6H079890; + AC	6 DPK 1195
				ALT	UNTIL CHA-NO.: 7H-6X022356; - AC	6 PK 1125
				ALT	UNTIL CHA-NO.: 7H-6X022356; + AC	6 DPK 1195
				W-P; CAM		ZRK 1338
				W-P; CAM		KT 1237
				W-P; CAM		KT 1237 W2

**1.9 TDI**

1896 ccm	75 kW	BRS	06.06 -	ALT	FROM CHA-NO.: 7H-6H079891; - AC	6 PK 1138
				ALT	FROM CHA-NO.: 7H-6H079891; + AC	6 DPK 1215
				ALT	FROM CHA-NO.: 7H-6X022357; - AC	6 PK 1138
				ALT	FROM CHA-NO.: 7H-6X022357; + AC	6 DPK 1215
				ALT	UNTIL CHA-NO.: 7H-6H079890; - AC	6 PK 1125
				ALT	UNTIL CHA-NO.: 7H-6H079890; + AC	6 DPK 1195
				ALT	UNTIL CHA-NO.: 7H-6X022356; - AC	6 PK 1125
				ALT	UNTIL CHA-NO.: 7H-6X022356; + AC	6 DPK 1195
				W-P; CAM		ZRK 1338
				W-P; CAM		KT 1237
				W-P; CAM		KT 1237 W2

**1.9 TDI**

1896 ccm	77 kW	AXB	04.03 -	ALT	FROM CHA-NO.: 7H-6H079891; - AC	6 PK 1138
				ALT	FROM CHA-NO.: 7H-6H079891; + AC	6 DPK 1215
				ALT	FROM CHA-NO.: 7H-6X022357; - AC	6 PK 1138
				ALT	FROM CHA-NO.: 7H-6X022357; + AC	6 DPK 1215
				ALT	UNTIL CHA-NO.: 7H-6H079890; - AC	6 PK 1125

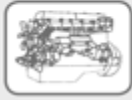

## VW

### TRANSPORTER T5 Pritsche/Fahrgestell (7JD, 7JE, 7JL, 7JY, 7JZ)

#### 1.9 TDI

1896 ccm	77 kW	AXB	04.03 -	ALT	UNTIL CHA-NO.: 7H-6H079890; + AC	6 DPK 1195
				ALT	UNTIL CHA-NO.: 7H-6X022356; - AC	6 PK 1125
				ALT	UNTIL CHA-NO.: 7H-6X022356; + AC	6 DPK 1195
				W-P; CAM		ZRK 1338
				W-P; CAM		KT 1237
				W-P; CAM		KT 1237 W2

#### 2.0 TDI

1968 ccm	62 kW	CAAA	09.09 -	ALT	- AC	6 PK 1078
				ALT	+ AC	6 PK 1555
				CAM	MTR-CODE: CAAA;CAAB;CAAC;CAAE;CCHA;CCHB;CFCA	ZRK 1572

#### 2.0 TDI

1968 ccm	75 kW	CAAB	09.09 -	ALT	- AC	6 PK 1078
				ALT	+ AC	6 PK 1555
				CAM	MTR-CODE: CAAA;CAAB;CAAC;CAAE;CCHA;CCHB;CFCA	ZRK 1572

#### 2.0 TDI

1968 ccm	84 kW	CAAD	05.11 -	CAM		ZRK 1572
----------	-------	------	---------	-----	--	----------

#### 2.0 TDI

1968 ccm	103 kW	CAAC	09.09 -	ALT	MTR-CODE: CAAA;CAAB;CAAC; - AC	6 PK 1078
				ALT	MTR-CODE: CAAA;CAAB;CAAC; + AC	6 PK 1555
				ALT	MTR-CODE: CCHA;CFCA; - AC	6 PK 1078
				ALT	MTR-CODE: CCHA;CFCA; + AC	6 PK 1555
				CAM	MTR-CODE: CAAA;CAAB;CAAC;CAAE;CCHA;CCHB;CFCA	ZRK 1572

#### 2.0 TDI 4motion

1968 ccm	103 kW	CAAC	09.09 -	ALT	MTR-CODE: CAAA;CAAB;CAAC; - AC	6 PK 1078
				ALT	MTR-CODE: CAAA;CAAB;CAAC; + AC	6 PK 1555
				ALT	MTR-CODE: CCHA;CFCA; - AC	6 PK 1078
				ALT	MTR-CODE: CCHA;CFCA; + AC	6 PK 1555
				CAM	MTR-CODE: CAAA;CAAB;CAAC;CAAE;CCHA;CCHB;CFCA	ZRK 1572
				W-P		ZRK 1585

#### 2.0 BiTDI

1968 ccm	132 kW	CFCA	09.09 -	ALT	- AC	6 PK 1078
				ALT	+ AC	6 PK 1555
				CAM	MTR-CODE: CAAA;CAAB;CAAC;CAAE;CCHA;CCHB;CFCA	ZRK 1572

#### 2.0 BiTDI 4motion

1968 ccm	132 kW	CFCA	09.09 -	ALT	- AC	6 PK 1078
				ALT	+ AC	6 PK 1555
				CAM	MTR-CODE: CAAA;CAAB;CAAC;CAAE;CCHA;CCHB;CFCA	ZRK 1572



**LKW**  
**TRUCKS**  
**POIDS LOURDS**  
**CAMIONES**

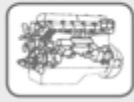

## DAF

### 45

#### 45.120-035

5880 ccm	85 kW	CD 85	05.91 - 12.00	ALT	FROM: 12.93; MOD: FA45.120-06	8 PK 1460 TM
				ALT	UNTIL: 11.93; AMP: 55; MOD: FA45.120-06	8 PK 1460 TM
				ALT	UNTIL: 11.93; MOD: FA45.120-06; - AMP: 100	8 PK 1400 TM

#### 45.120-06

5880 ccm	85 kW	CD 85	05.91 - 12.00	ALT	FROM: 12.93; MOD: FA45.120-06	8 PK 1460 TM
				ALT	UNTIL: 11.93; AMP: 55; MOD: FA45.120-06	8 PK 1460 TM
				ALT	UNTIL: 11.93; MOD: FA45.120-06; - AMP: 100	8 PK 1400 TM

#### 45.130.B06; 45.130.C06

5880 ccm	97 kW	CS 97 M;CT 97	05.91 - 12.00	ALT	FROM: 12.93; MTR-CODE: CN96;CS97M;CT97	8 PK 1460 TM
				ALT	UNTIL: 11.93; MTR-CODE: CN96;CS97M;CT97; - AMP: 100	8 PK 1400 TM
				ALT	UNTIL: 11.93; MTR-CODE: CN96;CS97M;CT97; AMP: 55	8 PK 1460 TM

#### 45.130.B08; 45.130.C08

5880 ccm	96-97 kW	CN 96;CS 97 M;CT 97	05.91 - 12.00	ALT	FROM: 12.93	8 PK 1460 TM
				ALT	UNTIL: 11.93; - AMP: 100	8 PK 1400 TM
				ALT	UNTIL: 11.93; AMP: 55	8 PK 1460 TM

#### 45.150.B08; 45.150.C08

5880 ccm	107-108 kW	CB 108;CS 107 M;CT 108	05.91 - 12.00	ALT	FROM: 12.93; MTR-CODE: CB108;CS107M	8 PK 1460 TM
				ALT	UNTIL: 11.93; MTR-CODE: CB108;CS107M; - AMP: 100	8 PK 1400 TM
				ALT	UNTIL: 11.93; MTR-CODE: CB108;CS107M; AMP: 55	8 PK 1460 TM

#### 45.150.B11; 45.150.C11

5880 ccm	107-108 kW	CB 108;CS 107 M;CT 108	05.91 - 12.00	ALT	FROM: 12.93; MTR-CODE: CB108;CS107M	8 PK 1460 TM
				ALT	UNTIL: 11.93; MTR-CODE: CB108;CS107M; - AMP: 100	8 PK 1400 TM
				ALT	UNTIL: 11.93; MTR-CODE: CB108;CS107M; AMP: 55	8 PK 1460 TM

#### 45.150.C09

5880 ccm	108 kW	CT 108	05.91 - 12.00	ALT	FROM: 12.93; MTR-CODE: CB108;CS107M	8 PK 1460 TM
				ALT	UNTIL: 11.93; MTR-CODE: CB108;CS107M; - AMP: 100	8 PK 1400 TM
				ALT	UNTIL: 11.93; MTR-CODE: CB108;CS107M; AMP: 55	8 PK 1460 TM

#### 45.150-10; 45.150.B10

5880 ccm	107-108 kW	CB 108;CS 107 M	05.91 - 12.00	ALT	FROM: 12.93	8 PK 1460 TM
				ALT	UNTIL: 11.93; - AMP: 100	8 PK 1400 TM
				ALT	UNTIL: 11.93; AMP: 55	8 PK 1460 TM

#### 45.160.C09

5880 ccm	119 kW	CS 119	05.91 - 12.00	ALT	FROM: 12.93; MTR-CODE: CS119;CS119;CT119; MOD: FA45.160C11	8 PK 1460 TM
				ALT	UNTIL: 11.93; MTR-CODE: CS119;CS119;CT119; AMP: 55; MOD: FA45.160C11	8 PK 1460 TM
				ALT	UNTIL: 11.93; MTR-CODE: CS119;CS119;CT119; MOD: FA45.160C11; - AMP: 100	8 PK 1400 TM

#### 45.160.C11

5880 ccm	119 kW	CS 119;CT 119	05.91 - 12.00	ALT	FROM: 12.93; MTR-CODE: CS119;CS119;CT119; MOD: FA45.160C11	8 PK 1460 TM
				ALT	UNTIL: 11.93; MTR-CODE: CS119;CS119;CT119; AMP: 55; MOD: FA45.160C11	8 PK 1460 TM
				ALT	UNTIL: 11.93; MTR-CODE: CS119;CS119;CT119; MOD: FA45.160C11; - AMP: 100	8 PK 1400 TM

### 55

#### 55.180.B13

5880 ccm	133 kW	CS 133 M	11.95 - 12.00	ALT	MOD: FA55.180B13	8 PK 1460 TM
----------	--------	----------	---------------	-----	------------------	--------------

#### 55.180.B15

5880 ccm	133 kW	CS 133 M	11.95 - 12.00	ALT	MOD: FA55.180B13	8 PK 1460 TM
----------	--------	----------	---------------	-----	------------------	--------------

#### 55.210.21

5880 ccm	158 kW	CS 158 M	11.95 - 12.00	ALT	MOD: FA55.210B13	8 PK 1460 TM
----------	--------	----------	---------------	-----	------------------	--------------

#### 55.210.B13

5880 ccm	158 kW	CS 158 M	11.95 - 12.00	ALT	MOD: FA55.210B13	8 PK 1460 TM
----------	--------	----------	---------------	-----	------------------	--------------

#### 55.210.B15

5880 ccm	158 kW	CS 158 M	11.95 - 12.00	ALT	MOD: FA55.210B13	8 PK 1460 TM
----------	--------	----------	---------------	-----	------------------	--------------



## DAF

65							
<b>65.180</b>							
6240 ccm	133 kW	NS 133 L;NS 133 M	03.93 - 02.98	ALT	MOD: FA 65.180;FAV 65.180; REQ: 2		AVX 13 x 1475 TM
<b>65.210</b>							
6240 ccm	156 kW	NS 156 L;NS 156 M	03.93 - 02.98	ALT	MOD: FA 65.210;FAV 65.210; REQ: 2		AVX 13 x 1475 TM
<b>65.240</b>							
6240 ccm	177 kW	NS 177 M	05.96 - 02.98	ALT	MOD: FA 65.240; REQ: 2		AVX 13 x 1475 TM
75							
<b>75.240</b>							
8650 ccm	180 kW	RS 180 L;RS 180 M	07.92 - 02.98	AC-C	MOD: FA 75.240		AVX 13 x 1300 TM
				ALT	MOD: FA 75.240		2-AVX 13 x 1625 TM
		RS 180;RS 180 L;RS 180 M		AC-C	MTR-CODE: RS 180 L;RS 180 M; MOD: FA 75.240		AVX 13 x 1300 TM
				ALT	MTR-CODE: RS 180 L;RS 180 M; MOD: FA 75.240		2-AVX 13 x 1625 TM
<b>75.270</b>							
8650 ccm	200 kW	RS 200 L;RS 200 M	07.92 - 02.98	AC-C	MOD: FA 75.270		AVX 13 x 1300 TM
				ALT	MOD: FA 75.270		2-AVX 13 x 1625 TM
		RS 200;RS 200 L;RS 200 M		AC-C	MTR-CODE: RS 200 L;RS 200 M; MOD: FA 75.270		AVX 13 x 1300 TM
				ALT	MTR-CODE: RS 200 L;RS 200 M; MOD: FA 75.270		2-AVX 13 x 1625 TM
<b>75.300</b>							
8650 ccm	222 kW	RS 222 L;RS 222 M	07.92 - 02.98	AC-C	MOD: FA 75.300		AVX 13 x 1300 TM
				ALT	MOD: FA 75.300		2-AVX 13 x 1625 TM
		RS 222;RS 222 L;RS 222 M		AC-C	MTR-CODE: RS 222 L;RS 222 M; MOD: FA 75.300		AVX 13 x 1300 TM
				ALT	MTR-CODE: RS 222 L;RS 222 M; MOD: FA 75.300		2-AVX 13 x 1625 TM
85							
<b>85.330</b>							
11600 ccm	242 kW	WS 242 L;WS 242 M	07.92 - 02.98	AC-C	MOD: FA 85.330		AVX 13 x 1400 TM
		WS 242;WS 242 L;WS 242 M		AC-C	MTR-CODE: WS 242 L;WS 242 M; MOD: FA 85.330		AVX 13 x 1400 TM
<b>85.360</b>							
11600 ccm	268 kW	WS 268 L;WS 268 M	07.92 - 02.98	AC-C	MOD: FA 85.360		AVX 13 x 1400 TM
		WS 268;WS 268 L;WS 268 M		AC-C	MTR-CODE: WS 268 L;WS 268 M; MOD: FA 85.360		AVX 13 x 1400 TM
<b>85.400</b>							
11600 ccm	295 kW	WS 295 M	03.95 - 02.98	AC-C	MOD: FA 85.400		AVX 13 x 1400 TM
95							
<b>95.310</b>							
11600 ccm	225 kW	WS 225	09.87 -	AC-C	MOD: FA 95.310; REQ: 2		AVX 13 x 1025 TM
				FAN	OE-NO.: 0398694;0067669; MOD: FA 95.310; REQ: 2		AVX 13 x 1275 TM
				FAN	OE-NO.: 0555461;0067670; MOD: FA 95.310; REQ: 2		AVX 13 x 1300 TM
				ALT			2/12,5 x 1950
				ALT	AMP: 95		2/12,5 x 2025
				ALT	AMP: 55; MOD: FA 95.310		2-AVX 13 x 1950 TM
				ALT	AMP: 95; MOD: FA 95.310		2-AVX 13 x 2025 TM
<b>95.330</b>							
11600 ccm	242 kW	WS 242	09.87 -	AC-C	MOD: FA 95.330; REQ: 2		AVX 13 x 1025 TM
				FAN	OE-NO.: 0398694;0067669; MOD: FA 95.330; REQ: 2		AVX 13 x 1275 TM
				FAN	OE-NO.: 0555461;0067670; MOD: FA 95.330; REQ: 2		AVX 13 x 1300 TM
				ALT			2/12,5 x 1950
				2. ALT	MTR-CODE: WS 242; OE-NO.: 1283100; MOD: FA 95.330		2-AVX 13 x 1950 TM
				ALT	MTR-CODE: WS 242; OE-NO.: 0394662;0090050; MOD: FA 95.330		2-AVX 13 x 1950 TM
				ALT	OE-NO.: 0394661;0090051; MOD: FA 95.330		2-AVX 13 x 2025 TM
<b>95.350</b>							
11600 ccm	259 kW	WS 259	09.87 -	AC-C	MOD: FA 95.350; REQ: 2		AVX 13 x 1025 TM
				FAN	OE-NO.: 0398694;0067669; MOD: FA 95.350; REQ: 2		AVX 13 x 1275 TM
				FAN	OE-NO.: 0555461;0067670; MOD: FA 95.350; REQ: 2		AVX 13 x 1300 TM



## DAF

**95**

<b>95.350</b>						
11600 ccm	259 kW	WS 259	09.87 -	ALT		2/12,5 x 1950
				ALT	AMP: 95	2/12,5 x 2025
				ALT	AMP: 55; MOD: FA 95.350	2-AVX 13 x 1950 TM
				ALT	AMP: 95; MOD: FA 95.350	2-AVX 13 x 2025 TM
<b>95.360</b>						
11600 ccm	268 kW	WS 268;WS 268 G;WS 268 L;WS 268 M	08.90 -	AC-C	MTR-CODE: WS 268;WS 268 G; MOD: FA 95.360; REQ: 2	AVX 13 x 1025 TM
				FAN	MTR-CODE: WS 268;WS 268 G; OE-NO.: 0398694;0067669; MOD: FA 95.360; REQ: 2	AVX 13 x 1275 TM
				FAN	MTR-CODE: WS 268;WS 268 G; OE-NO.: 0555461;0067670; MOD: FA 95.360; REQ: 2	AVX 13 x 1300 TM
				ALT		2/12,5 x 1950
				2. ALT	MTR-CODE: WS 268;WS 268 G; OE-NO.: 1283100; MOD: FA 95.360	2-AVX 13 x 1950 TM
				ALT	MTR-CODE: WS 268;WS 268 G; OE-NO.: 0394661;0090051; MOD: FA 95.360	2-AVX 13 x 2025 TM
				ALT	MTR-CODE: WS 268;WS 268 G; OE-NO.: 0394662;0090050; MOD: FA 95.360	2-AVX 13 x 1950 TM
		WS 268;WS 268 L;WS 268 M		AC-C	MTR-CODE: WS 268;WS 268 G; MOD: FA 95.360; REQ: 2	AVX 13 x 1025 TM
				FAN	MTR-CODE: WS 268;WS 268 G; OE-NO.: 0398694;0067669; MOD: FA 95.360; REQ: 2	AVX 13 x 1275 TM
				FAN	MTR-CODE: WS 268;WS 268 G; OE-NO.: 0555461;0067670; MOD: FA 95.360; REQ: 2	AVX 13 x 1300 TM
				ALT		2/12,5 x 1950
				2. ALT	MTR-CODE: WS 268;WS 268 G; OE-NO.: 1283100; MOD: FA 95.360	2-AVX 13 x 1950 TM
				ALT	MTR-CODE: WS 268;WS 268 G; OE-NO.: 0394661;0090051; MOD: FA 95.360	2-AVX 13 x 2025 TM
				ALT	MTR-CODE: WS 268;WS 268 G; OE-NO.: 0394662;0090050; MOD: FA 95.360	2-AVX 13 x 1950 TM
<b>95.380</b>						
11600 ccm	282 kW	WS 282	09.87 -	AC-C	MOD: FA 95.380; REQ: 2	AVX 13 x 1025 TM
				FAN	OE-NO.: 0398694;0067669; MOD: FA 95.380; REQ: 2	AVX 13 x 1275 TM
				FAN	OE-NO.: 0555461;0067670; MOD: FA 95.380; REQ: 2	AVX 13 x 1300 TM
				ALT		2/12,5 x 1950
				ALT	AMP: 95	2/12,5 x 2025
				ALT	AMP: 55; MOD: FA 95.380	2-AVX 13 x 1950 TM
				ALT	AMP: 95; MOD: FA 95.380	2-AVX 13 x 2025 TM
<b>95.400</b>						
11600 ccm	295 kW	WS 295;WS 295 G;WS 295 L;WS 295 M	08.90 -	AC-C	MTR-CODE: WS 295;WS 295 G; MOD: FA 95.400; REQ: 2	AVX 13 x 1025 TM
				FAN	MTR-CODE: WS 295;WS 295 G; OE-NO.: 0398694;0067669; MOD: FA 95.400; REQ: 2	AVX 13 x 1275 TM
				FAN	MTR-CODE: WS 295;WS 295 G; OE-NO.: 0555461;0067670; MOD: FA 95.400; REQ: 2	AVX 13 x 1300 TM
				ALT		2/12,5 x 1950
				2. ALT	MTR-CODE: WS 295;WS 295 G; OE-NO.: 1283100; MOD: FA 95.400	2-AVX 13 x 1950 TM
				ALT	MTR-CODE: WS 295;WS 295 G; OE-NO.: 0394661;0090051; MOD: FA 95.400	2-AVX 13 x 2025 TM
				ALT	MTR-CODE: WS 295;WS 295 G; OE-NO.: 0394662;0090050; MOD: FA 95.400	2-AVX 13 x 1950 TM
		WS 295;WS 295 L;WS 295 M		AC-C	MTR-CODE: WS 295;WS 295 G; MOD: FA 95.400; REQ: 2	AVX 13 x 1025 TM
				FAN	MTR-CODE: WS 295;WS 295 G; OE-NO.: 0398694;0067669; MOD: FA 95.400; REQ: 2	AVX 13 x 1275 TM
				FAN	MTR-CODE: WS 295;WS 295 G; OE-NO.: 0555461;0067670; MOD: FA 95.400; REQ: 2	AVX 13 x 1300 TM
				2. ALT	MTR-CODE: WS 295;WS 295 G; OE-NO.: 1283100; MOD: FA 95.400	2-AVX 13 x 1950 TM
				ALT	MTR-CODE: WS 295;WS 295 G; OE-NO.: 0394661;0090051; MOD: FA 95.400	2-AVX 13 x 2025 TM
				ALT	MTR-CODE: WS 295;WS 295 G; OE-NO.: 0394662;0090050; MOD: FA 95.400	2-AVX 13 x 1950 TM
<b>95.430</b>						
11600 ccm	315 kW	WS 315;WS 315 G;WS 315 L;WS 315 M	02.92 -	AC-C	MTR-CODE: WS 315;WS 315 G; MOD: FA 95.430; REQ: 2	AVX 13 x 1025 TM
				FAN	MTR-CODE: WS 315;WS 315 G; OE-NO.: 0398694;0067669; MOD: FA 95.430; REQ: 2	AVX 13 x 1275 TM



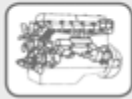

## DAF

### 95

95.430						
11600 ccm	315 kW	WS 315;WS 315 G;WS 315 L;WS 315 M	02.92 -	FAN	MTR-CODE: WS 315;WS 315 G; OE-NO.: 0555461;0067670; MOD: FA 95.430; REQ: 2	AVX 13 x 1300 TM
				2. ALT	MTR-CODE: WS 315;WS 315 G; OE-NO.: 1283100; MOD: FA 95.430	2-AVX 13 x 1950 TM
				ALT	MTR-CODE: WS 315;WS 315 G; OE-NO.: 0394661;0090051; MOD: FA 95.430	2-AVX 13 x 2025 TM
				ALT	MTR-CODE: WS 315;WS 315 G; OE-NO.: 0394662;0090050; MOD: FA 95.430	2-AVX 13 x 1950 TM
		WS 315;WS 315 L;WS 315 M		AC-C	MTR-CODE: WS 315;WS 315 G; MOD: FA 95.430; REQ: 2	AVX 13 x 1025 TM
				FAN	MTR-CODE: WS 315;WS 315 G; OE-NO.: 0398694;0067669; MOD: FA 95.430; REQ: 2	AVX 13 x 1275 TM
				FAN	MTR-CODE: WS 315;WS 315 G; OE-NO.: 0555461;0067670; MOD: FA 95.430; REQ: 2	AVX 13 x 1300 TM
				ALT		2/12,5 x 1950
				2. ALT	MTR-CODE: WS 315;WS 315 G; OE-NO.: 1283100; MOD: FA 95.430	2-AVX 13 x 1950 TM
				ALT	MTR-CODE: WS 315;WS 315 G; OE-NO.: 0394661;0090051; MOD: FA 95.430	2-AVX 13 x 2025 TM
				ALT	MTR-CODE: WS 315;WS 315 G; OE-NO.: 0394662;0090050; MOD: FA 95.430	2-AVX 13 x 1950 TM

95.500						
14000 ccm	373 kW	VF 373 M	02.94 - 01.98	AC-C	MOD: FT 95.500	AVX 13 x 1075 TM
				ALT	MOD: FT95.500	10 PK 1360 TM
				W-P	MOD: FT95.500	6 PK 1110 TM

### 65 CF

65.180						
6240 ccm	133 kW	NS 133 M	02.98 - 12.00	ALT	MOD: FA 65 CF 180; REQ: 2	AVX 13 x 1475 TM

65.210						
6240 ccm	156 kW	NS 156 M	02.98 - 12.00	ALT	MOD: FA 65 CF 210; REQ: 2	AVX 13 x 1475 TM

65.240						
6240 ccm	177 kW	NS 177 M	02.98 - 12.00	ALT	MOD: FA 65 CF 240; REQ: 2	AVX 13 x 1475 TM

### 75 CF

75.250						
9200 ccm	183 kW	PF 183 M	02.98 - 12.00	AC-C	MOD: FA 75 CF 250	AVX 13 x 1300 TM
				ALT	OE-NO.: 1289200; MOD: FA 75 CF 250	2-AVX 13 x 1625 TM
				ALT	OE-NO.: 1398637; MOD: FA75CF250	8 PK 2380 TM

75.290						
9200 ccm	212 kW	PF 212 M	02.98 - 12.00	AC-C	MOD: FA 75 CF 290	AVX 13 x 1300 TM
				ALT	MOD: FA 75 CF 290	2-AVX 13 x 1625 TM

75.320						
9200 ccm	235 kW	PF 235 M	02.98 - 12.00	AC-C	MOD: FA 75 CF 320	AVX 13 x 1300 TM
				ALT	MOD: FA 75 CF 320	2-AVX 13 x 1625 TM

### 85 CF

85.340						
12580 ccm	250 kW	XF 250 M	02.98 - 12.00	AC-C	OE-NO.: 0759749;0067667; MOD: FA 85 CF 340	AVX 13 x 1025 TM
				AC-C	OE-NO.: 1425709; MOD: FA 85 CF 340	AVX 13 x 1000 TM
				ALT	OE-NO.: 0067669; MOD: FA 85 CF 340; REQ: 2	AVX 13 x 1275 TM
				ALT	OE-NO.: 1364060; MOD: FA85CF340	7 PK 1705 TM

85.380						
12580 ccm	280 kW	XF 280 M	02.98 - 12.00	AC-C	OE-NO.: 0759749;0067667; MOD: FA 85 CF 380	AVX 13 x 1025 TM
				AC-C	OE-NO.: 1425709; MOD: FA 85 CF 380	AVX 13 x 1000 TM
				ALT	OE-NO.: 0067669; MOD: FA 85 CF 380; REQ: 2	AVX 13 x 1275 TM
				ALT	OE-NO.: 1364060; MOD: FA85CF380	7 PK 1705 TM

85.430						
12580 ccm	315 kW	XF 315 M	02.98 - 12.00	AC-C	MTR-CODE: XF 315 M; MOD: FA 85 CF 430	AVX 13 x 1025 TM
				AC-C	OE-NO.: 1425709; MOD: FA 85 CF 430	AVX 13 x 1000 TM
				AIR-C	MTR-CODE: XF 315 M; OE-NO.: 0759749;0067667; MOD: FA 85 CF 430	AVX 13 x 1025 TM
				ALT	MTR-CODE: XF 315 M; MOD: FA 85 CF 430; REQ: 2; + PUL	AVX 13 x 1275 TM
				FAN	MTR-CODE: XF 315 M; OE-NO.: 0067669; MOD: FA 85 CF 430; REQ: 2	AVX 13 x 1275 TM
				ALT	OE-NO.: 1364060; MOD: FA85CF430	7 PK 1705 TM

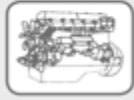

## DAF

### 95 XF

95.380						
12580 ccm	280 kW	XE 280 C;XF 280 M	01.97 - 09.02	AC-C	MOD: FA 95 XF 380	AVX 13 x 1025 TM
				AC-C	MTR-CODE: XF 280 M; MOD: FA 95 XF 380	AVX 13 x 1025 TM
				ALT	MOD: FA 95 XF 380	AVX 13 x 1950 TM
				ALT	MTR-CODE: XF 280 M; MOD: FA 95 XF 380	AVX 13 x 1950 TM
				FAN	MOD: FA 95 XF 380	AVX 13 x 1275 TM
				FAN	MTR-CODE: XF 280 M; MOD: FA 95 XF 380	AVX 13 x 1275 TM
		XF 280 M		AC-C	MOD: FA 95 XF 380	AVX 13 x 1025 TM
				ALT	MOD: FA 95 XF 380	AVX 13 x 1950 TM
				FAN	MOD: FA 95 XF 380	AVX 13 x 1275 TM

95.430						
12580 ccm	315 kW	XE 315 C;XF 315 M	01.97 - 09.02	AC-C	MTR-CODE: XF 250 M; OE-NO.: 0759749;0067667; MOD: 95 XF 340	AVX 13 x 1025 TM
				AC-C	MTR-CODE: XF 250 M; OE-NO.: 1333364;1388100; MOD: 95 XF 340; REQ: 2	AVX 13 x 1225 TM
				AC-C	MTR-CODE: XF 250 M; OE-NO.: 1425709; MOD: 95 XF 340	AVX 13 x 1000 TM
				AC-C	MTR-CODE: XF 315 M; OE-NO.: 1425709; MOD: FA 95 XF 430	AVX 13 x 1000 TM
				AIR-C	MTR-CODE: XF 315 M; OE-NO.: 0759749;0067667; MOD: FA 95 XF 430	AVX 13 x 1025 TM
				FAN	MTR-CODE: XF 250 M; OE-NO.: 0067669; MOD: 95 XF 340; REQ: 2	AVX 13 x 1275 TM
				FAN	MTR-CODE: XF 315 M; OE-NO.: 0067669; MOD: FA 95 XF 430; REQ: 2	AVX 13 x 1275 TM
				W-P	MTR-CODE: XF 315 M; OE-NO.: 1333364;1388100; MOD: FA 95 XF 430; REQ: 2	AVX 13 x 1225 TM
		XF 315 M		AC-C	MTR-CODE: XF 250 M; OE-NO.: 0759749;0067667; MOD: 95 XF 340	AVX 13 x 1025 TM
				AC-C	MTR-CODE: XF 250 M; OE-NO.: 1333364;1388100; MOD: 95 XF 340; REQ: 2	AVX 13 x 1225 TM
				AC-C	MTR-CODE: XF 250 M; OE-NO.: 1425709; MOD: 95 XF 340	AVX 13 x 1000 TM
				AC-C	MTR-CODE: XF 315 M; OE-NO.: 1425709; MOD: FA 95 XF 430	AVX 13 x 1000 TM
				AIR-C	MTR-CODE: XF 315 M; OE-NO.: 0759749;0067667; MOD: FA 95 XF 430	AVX 13 x 1025 TM
				FAN	MTR-CODE: XF 250 M; OE-NO.: 0067669; MOD: 95 XF 340; REQ: 2	AVX 13 x 1275 TM
				FAN	MTR-CODE: XF 315 M; OE-NO.: 0067669; MOD: FA 95 XF 430; REQ: 2	AVX 13 x 1275 TM
				W-P	MTR-CODE: XF 315 M; OE-NO.: 1333364;1388100; MOD: FA 95 XF 430; REQ: 2	AVX 13 x 1225 TM

95.480						
12580 ccm	355 kW	XE 355 C;XF 355 M	01.97 - 09.02	AC-C	OE-NO.: 0759749;0067667; MOD: FA 95 XF 480	AVX 13 x 1025 TM
				AC-C	OE-NO.: 1425709; MOD: FA 95 XF 480	AVX 13 x 1000 TM
				ALT	OE-NO.: 0067669; MOD: FA 95 XF 480; REQ: 2	AVX 13 x 1275 TM
				ALT	OE-NO.: 1333364;1388100; MOD: FA 95 XF 480; REQ: 2	AVX 13 x 1225 TM

95.530						
14000 ccm	390 kW	VF 390 M	01.97 -	AC-C	MOD: FA 95 XF 530	AVX 13 x 1275 TM
				ALT	MOD: FA95XF530	10 PK 1360 TM
				W-P	MTR-CODE: VF390M; MOD: FA95XF530	6 PK 1015 TM

### CF 65

65.180						
5880 ccm	136 kW	CE 136 C	01.01 -	AC-C	MOD: FA65.180	8 PK 1515 TM
				ALT	MOD: FA65.180	8 PK 1220 TM

65.220						
5880 ccm	162 kW	CE 162 C	01.01 -	AC-C	MOD: FA65.220	8 PK 1515 TM
				ALT	MOD: FA65.220	8 PK 1220 TM

### CF 75

75.250						
9200 ccm	183 kW	PE 183 C;PR 183 S	01.01 -	AC-C	MTR-CODE: PE 183 C; MOD: FA 75.250	AVX 13 x 1300 TM
				ALT	MTR-CODE: PE183C; MOD: FA75.250	8 PK 2380 TM

75.310						
9200 ccm	228 kW	PE 228 C;PR 228 S	01.01 -	AC-C	MTR-CODE: PE 228 C; MOD: FA 75.310	AVX 13 x 1300 TM
				ALT	MTR-CODE: PE228C; MOD: FA75.310	8 PK 2380 TM

75.360						
9200 ccm	265 kW	PE 265 C;PR 265 S	01.01 -	AC-C	MTR-CODE: PE 265 C; MOD: FA 75.360	AVX 13 x 1300 TM

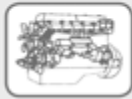

## DAF

### CF 75

#### 75.360

9200 ccm 265 kW PE 265 C;PR 265 S 01.01 - ALT MTR-CODE: PE265C; MOD: FA75.360 8 PK 2380 TM

### CF 85

#### 85.340

12580 ccm 250 kW XE 250 C 01.01 - AC-C MOD: FA 85.340;FAD AVX 13 x 1000 TM  
AC-C MTR-CODE: XE 250 C; MOD: FA 85.340;FAD AVX 13 x 1000 TM  
ALT OE-NO.: 1333734;1364060; MOD: FA85.340/FAD 7 PK 1705 TM  
ALT OE-NO.: 1393280; MOD: FA85.340/FAD 8 PK 2045 TM  
ALT OE-NO.: 1393365; MOD: FA85.340/FAD 8 PK 1715 TM

#### 85.380

12580 ccm 280 kW XE 280 C 01.01 - AC-C MOD: FA 85.380 AVX 13 x 1000 TM  
ALT OE-NO.: 1333734;1364060; MOD: FA85.380 7 PK 1705 TM  
ALT OE-NO.: 1393280; MOD: FA85.380 8 PK 2045 TM  
ALT OE-NO.: 1393365; MOD: FA85.380 8 PK 1715 TM

#### 85.430

12580 ccm 315 kW XE 315 C 01.01 - AC-C MOD: FA 85.430 AVX 13 x 1000 TM  
ALT OE-NO.: 1333734; MOD: FA85.430 7 PK 1705 TM  
ALT OE-NO.: 1393365; MOD: FA85.430 8 PK 1715 TM

#### 85.480

12580 ccm 355 kW XE 355 C 01.01 - AC-C MOD: FA 85.480 AVX 13 x 1000 TM  
ALT MOD: FA85.480 8 PK 1715 TM

### F 600

#### 600

5880 ccm 85 kW CD 85 12.86 - 12.92 ALT MOD: FA600CD 8 PK 1400 TM

### F 800

#### 800

5880 ccm 96 kW CN 96 12.86 - 08.91 ALT MOD: FA800CN 8 PK 1400 TM  
108 kW CB 108 ALT MOD: FA800CB 8 PK 1400 TM

### F 900

#### 900

5750 ccm 77 kW DD 575 01.75 - 11.88 ALT MOD: FA 900 BDD AVX 13 x 1225 TM  
ALT MOD: FA 900 BDD; REQ: 2 AVX 13 x 1450 TM  
ALT MOD: FA 900 BDD; REQ: 2 AVX 13 x 1500 TM  
ALT MOD: FA 900 BDD 2-AVX 13 x 1450 TM  
ALT MOD: FA 900 BDD 2-AVX 13 x 1500 TM

### F 1000

#### 1000

5880 ccm 96 kW CN 96 12.86 - 12.92 ALT MOD: FA1000CN 8 PK 1400 TM  
108 kW CB 108 ALT MOD: FA1000CB 8 PK 1400 TM

### F 1100

#### 1100

5750 ccm 77 kW DD 575 01.78 - 11.90 ALT MOD: FA 1100 DD AVX 13 x 1225 TM  
ALT MOD: FA 1100 DD; REQ: 2 AVX 13 x 1450 TM  
ALT MOD: FA 1100 DD; REQ: 2 AVX 13 x 1500 TM  
ALT MOD: FA 1100 DD 2-AVX 13 x 1450 TM  
ALT MOD: FA 1100 DD 2-AVX 13 x 1500 TM  
6150 ccm 85 kW DF 615 ALT MOD: FA 1100 DF AVX 13 x 1225 TM  
ALT MOD: FA 1100 DF; REQ: 2 AVX 13 x 1225 TM  
ALT MOD: FA 1100 DF; REQ: 2 AVX 13 x 1450 TM  
ALT MOD: FA 1100 DF; REQ: 2 AVX 13 x 1500 TM  
ALT MOD: FA 1100 DF 2-AVX 13 x 1450 TM  
ALT MOD: FA 1100 DF 2-AVX 13 x 1500 TM  
ALT MOD: FA 1100 DT AVX 13 x 1225 TM  
ALT MOD: FA 1100 DT; REQ: 2 AVX 13 x 1225 TM  
ALT MOD: FA 1100 DT; REQ: 2 AVX 13 x 1450 TM  
ALT MOD: FA 1100 DT; REQ: 2 AVX 13 x 1500 TM  
ALT MOD: FA 1100 DT 2-AVX 13 x 1450 TM  
ALT MOD: FA 1100 DT 2-AVX 13 x 1500 TM  
6240 ccm 116 kW DNTD 620 ALT MOD: FA 1100 DNTD; REQ: 2 AVX 13 x 1500 TM

### F 1300

#### 1300

6150 ccm 85 kW DF 615 07.78 - 12.92 ALT MOD: FA 1300 DF; REQ: 2 AVX 13 x 1450 TM  
ALT MOD: FA 1300 DF; REQ: 2 AVX 13 x 1500 TM  
ALT MOD: FA 1300 DF 2-AVX 13 x 1450 TM

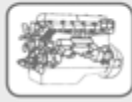

## DAF

F 1300										
<b>1300</b>										
6150 ccm	85 kW	DF 615	07.78 - 12.92	ALT	MOD: FA 1300 DF	2-AVX 13 x 1500 TM				
				ALT	MOD: FA 1300 DT; REQ: 2	AVX 13 x 1450 TM				
				ALT	MOD: FA 1300 DT; REQ: 2	AVX 13 x 1500 TM				
				ALT	MOD: FA 1300 DT	2-AVX 13 x 1450 TM				
				ALT	MOD: FA 1300 DT	2-AVX 13 x 1500 TM				
6240 ccm	116 kW	DNTD 620;NT 116		ALT	REQ: 2	AVX 13 x 1500 TM				
				ALT	REQ: 2	AVX 13 x 1500 TM				
<b>1305</b>										
6150 ccm	111 kW	DT 615	07.78 - 02.90	ALT	MOD: FA 1300 DT; REQ: 2	AVX 13 x 1450 TM				
				ALT	MOD: FA 1300 DT; REQ: 2	AVX 13 x 1500 TM				
				ALT	MOD: FA 1300 DT	2-AVX 13 x 1450 TM				
				ALT	MOD: FA 1300 DT	2-AVX 13 x 1500 TM				
F 1500										
<b>1500</b>										
6150 ccm	85 kW	DF 615	07.78 -	ALT	REQ: 2	AVX 13 x 1450 TM				
				ALT	REQ: 2	AVX 13 x 1500 TM				
				ALT		2-AVX 13 x 1450 TM				
				ALT		2-AVX 13 x 1500 TM				
	111-113 kW	DT 615			ALT	MOD: FT 1500 DT; REQ: 2	AVX 13 x 1450 TM			
					ALT	MOD: FT 1500 DT; REQ: 2	AVX 13 x 1500 TM			
					ALT		2-AVX 13 x 1500 TM			
	111 kW				ALT	REQ: 2	AVX 13 x 1450 TM			
					ALT	REQ: 2	AVX 13 x 1500 TM			
					ALT		2-AVX 13 x 1450 TM			
	111-113 kW				ALT		2-AVX 13 x 1500 TM			
					ALT	MOD: FT 1500 DT	2-AVX 13 x 1450 TM			
					ALT	MOD: FT 1500 DT	2-AVX 13 x 1500 TM			
F 1600										
<b>1600</b>										
6150 ccm	85 kW	DF 615	01.70 - 08.91	ALT	MOD: FA 1600 DF; REQ: 2	AVX 13 x 1300 TM				
				ALT	MOD: FA 1600 DF; REQ: 2	AVX 13 x 1325 TM				
				ALT	MOD: FA 1600 DF; REQ: 2	AVX 13 x 1375 TM				
				ALT	MOD: FA 1600 DF; REQ: 2	AVX 13 x 1400 TM				
				ALT	MOD: FA 1600 DF; REQ: 2	AVX 13 x 1425 TM				
				ALT	MOD: FA 1600 DF; REQ: 2	AVX 13 x 1450 TM				
				ALT	MOD: FA 1600 DF; REQ: 2	AVX 13 x 1500 TM				
				ALT	MOD: FA 1600 DF; REQ: 2	AVX 13 x 1525 TM				
				ALT	MOD: FA 1600 DF; REQ: 2	AVX 13 x 1575 TM				
				ALT	MTR-CODE: DF 615; MOD: FA 1600 DF	AVX 13 x 1350 TM				
				ALT	MTR-CODE: DF 615; MOD: FA 1600 DF; REQ: 2	AVX 13 x 1350 TM				
				ALT	MOD: FA 1600 DF	2-AVX 13 x 1575 TM				
				111 kW	DT 615			ALT	MOD: FA 1600 DT; REQ: 2	AVX 13 x 1300 TM
								ALT	MOD: FA 1600 DT; REQ: 2	AVX 13 x 1325 TM
								ALT	MOD: FA 1600 DT; REQ: 2	AVX 13 x 1375 TM
	ALT	MOD: FA 1600 DT; REQ: 2	AVX 13 x 1400 TM							
	ALT	MOD: FA 1600 DT; REQ: 2	AVX 13 x 1425 TM							
	ALT	MOD: FA 1600 DT; REQ: 2	AVX 13 x 1450 TM							
	ALT	MOD: FA 1600 DT; REQ: 2	AVX 13 x 1500 TM							
	ALT	MOD: FA 1600 DT; REQ: 2	AVX 13 x 1525 TM							
	ALT	MOD: FA 1600 DT; REQ: 2	AVX 13 x 1575 TM							
	ALT	MTR-CODE: DT 615; MOD: FA 1600 DT	AVX 13 x 1350 TM							
	ALT	MTR-CODE: DT 615; MOD: FA 1600 DT; REQ: 2	AVX 13 x 1350 TM							
	ALT	MOD: FA 1600 DT	2-AVX 13 x 1575 TM							
	<b>1600; 1621</b>									
	6150 ccm	111 kW	DT 615	01.73 - 08.91	ALT	MOD: FA 1600 DT; REQ: 2	AVX 13 x 1300 TM			
					ALT	MOD: FA 1600 DT; REQ: 2	AVX 13 x 1325 TM			
ALT					MOD: FA 1600 DT; REQ: 2	AVX 13 x 1375 TM				
ALT					MOD: FA 1600 DT; REQ: 2	AVX 13 x 1400 TM				
ALT					MOD: FA 1600 DT; REQ: 2	AVX 13 x 1425 TM				
ALT					MOD: FA 1600 DT; REQ: 2	AVX 13 x 1450 TM				
ALT					MOD: FA 1600 DT; REQ: 2	AVX 13 x 1500 TM				
ALT					MOD: FA 1600 DT; REQ: 2	AVX 13 x 1525 TM				
ALT					MOD: FA 1600 DT; REQ: 2	AVX 13 x 1575 TM				
ALT					MTR-CODE: DT 615; MOD: FA 1600 DT	AVX 13 x 1350 TM				
ALT					MTR-CODE: DT 615; MOD: FA 1600 DT; REQ: 2	AVX 13 x 1350 TM				
ALT					MOD: FA 1600 DT	2-AVX 13 x 1575 TM				

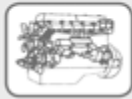

## DAF

### F 1700

#### 1700

6240 ccm	116 kW	DNTD 620;NT 116	12.86 - 02.95	ALT	REQ: 2	AVX 13 x 1500 TM
	132-133 kW	DNT 620;NT 133		ALT	REQ: 2	AVX 13 x 1500 TM
	156 kW	DNS 620		ALT	MOD: FA 1700 DNS; REQ: 2	AVX 13 x 1500 TM

### F 1900

#### 1900

6240 ccm	132-133 kW	DNT 620;NT 133	12.86 - 09.93	ALT	REQ: 2	AVX 13 x 1500 TM
	156 kW	DNS 620		ALT	MTR-CODE: DNS 620;DNS 620; MOD: FA 1900 DNS; REQ: 2	AVX 13 x 1500 TM
		DNS 620;NS 156		ALT	MTR-CODE: DNS 620;DNS 620; MOD: FA 1900 DNS; REQ: 2	AVX 13 x 1500 TM

### F 2100

#### 2100

8250 ccm	115 kW	DH 825	07.78 - 08.91	AC-C	MTR-CODE: DH 825; OE-NO.: 0283164; MOD: FA 2100 DH; L; REQ: 2	AVX 13 x 1450 TM
				ALT	OE-NO.: 0293009; MOD: FA 2100 DH; L; REQ: 2	AVX 13 x 1475 TM
				W-P	MTR-CODE: DH 825; MOD: FA 2100 DH; R; REQ: 2	AVX 13 x 1450 TM
				ALT	MOD: FA 2100 DH; L	2-AVX 13 x 1500 TM

#### 2100; 2103; 2105

8250 ccm	150-156 kW	DHR 825;DHTD 825	07.78 - 09.86	AC-C	MTR-CODE: DHR 825;DHTD 825; OE-NO.: 0283164; L; REQ: 2	AVX 13 x 1450 TM
				ALT	MTR-CODE: DHR 825;DHTD 825; R; REQ: 2	AVX 13 x 1450 TM
				ALT	OE-NO.: 0293009; L; REQ: 2	AVX 13 x 1475 TM
				ALT	L	2-AVX 13 x 1500 TM

#### 2100; 2105

8250 ccm	115 kW	DH 825	07.78 - 08.91	AC-C	MTR-CODE: DH 825; OE-NO.: 0283164; MOD: FA 2100 DH; L; REQ: 2	AVX 13 x 1450 TM
				ALT	MTR-CODE: DH 825; MOD: FA 2100 DH; R; REQ: 2	AVX 13 x 1450 TM
				ALT	OE-NO.: 0293009; MOD: FA 2100 DH; L; REQ: 2	AVX 13 x 1475 TM
				ALT	MOD: FA 2100 DH; L	2-AVX 13 x 1500 TM
	150-151 kW	DHR 825;DHTD 825		AC-C	MTR-CODE: DHR 825;DHTD 825; OE-NO.: 0283164; L; REQ: 2	AVX 13 x 1450 TM
				ALT	MTR-CODE: DHR 825;DHTD 825; R; REQ: 2	AVX 13 x 1450 TM
				ALT	OE-NO.: 0293009; L; REQ: 2	AVX 13 x 1475 TM
				ALT	L	2-AVX 13 x 1500 TM

#### 2103

8250 ccm	115 kW	DH 825	07.78 - 08.91	AC-C	MTR-CODE: DH 825; OE-NO.: 0283164; MOD: FA 2100 DH; L; REQ: 2	AVX 13 x 1450 TM
				ALT	MTR-CODE: DH 825; MOD: FA 2100 DH; R; REQ: 2	AVX 13 x 1450 TM
				ALT	OE-NO.: 0293009; MOD: FA 2100 DH; L; REQ: 2	AVX 13 x 1475 TM
				ALT	MOD: FA 2100 DH; L	2-AVX 13 x 1500 TM
	151-156 kW	DHTD 825		AC-C	MTR-CODE: DHTD 825; OE-NO.: 0283164; MOD: FA 2105 DHTD; L; REQ: 2	AVX 13 x 1450 TM
				ALT	MTR-CODE: DHTD 825; MOD: FA 2105 DHTD; R; REQ: 2	AVX 13 x 1450 TM
				ALT	OE-NO.: 0293009; MOD: FA 2105 DHTD; L; REQ: 2	AVX 13 x 1475 TM
				ALT	MOD: FA 2105 DHTD; L	2-AVX 13 x 1500 TM
	162 kW	DHT 825		AC-C	MTR-CODE: DHT 825; OE-NO.: 0283164; MOD: FA 2105 DHT; L; REQ: 2	AVX 13 x 1450 TM
				ALT	MTR-CODE: DHT 825; MOD: FA 2105 DHT; R; REQ: 2	AVX 13 x 1450 TM
				ALT	OE-NO.: 0293009; MOD: FA 2105 DHT; L; REQ: 2	AVX 13 x 1475 TM
				ALT	MOD: FA 2105 DHT; L	2-AVX 13 x 1500 TM
	167 kW			AC-C	MTR-CODE: DHT 825; OE-NO.: 0283164; MOD: FAS 2103 DHT; L; REQ: 2	AVX 13 x 1450 TM
				ALT	MTR-CODE: DHT 825; MOD: FAS 2103 DHT; R; REQ: 2	AVX 13 x 1450 TM
				ALT	OE-NO.: 0293009; MOD: FAS 2103 DHT; L; REQ: 2	AVX 13 x 1475 TM
				ALT	MOD: FAS 2103 DHT; L	2-AVX 13 x 1500 TM

#### 2103; 2105

8250 ccm	115 kW	DH 825	06.86 - 08.91	AC-C	MTR-CODE: DH 825; OE-NO.: 0283164; MOD: FA 2100 DH; L; REQ: 2	AVX 13 x 1450 TM
				ALT	MTR-CODE: DH 825; MOD: FA 2100 DH; R; REQ: 2	AVX 13 x 1450 TM

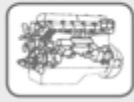
**DAF**
**F 2100**

<b>2103; 2105</b>						
8250 ccm	115 kW	DH 825	06.86 - 08.91	ALT	OE-NO.: 0293009; MOD: FA 2100 DH; L; REQ: 2	<b>AVX 13 x 1475 TM</b>
				ALT	MOD: FA 2100 DH; L	<b>2-AVX 13 x 1500 TM</b>
<b>2105</b>						
8250 ccm	115 kW	DH 825	07.78 - 08.91	AC-C	MTR-CODE: DH 825; OE-NO.: 0283164; MOD: FA 2100 DH; L; REQ: 2	<b>AVX 13 x 1450 TM</b>
				ALT	OE-NO.: 0293009; MOD: FA 2100 DH; L; REQ: 2	<b>AVX 13 x 1475 TM</b>
				W-P	MTR-CODE: DH 825; MOD: FA 2100 DH; R; REQ: 2	<b>AVX 13 x 1450 TM</b>
				ALT	MOD: FA 2100 DH; L	<b>2-AVX 13 x 1500 TM</b>
150-156 kW		DHR 825;DHTD 825		AC-C	MTR-CODE: DHR 825;DHTD 825; OE-NO.: 0283164; L; REQ: 2	<b>AVX 13 x 1450 TM</b>
				ALT	MTR-CODE: DHR 825;DHTD 825; R; REQ: 2	<b>AVX 13 x 1450 TM</b>
				ALT	OE-NO.: 0293009; L; REQ: 2	<b>2-AVX 13 x 1500 TM</b>
151-156 kW		DHTD 825		AC-C	MTR-CODE: DHTD 825; OE-NO.: 0283164; MOD: FA 2105 DHTD; L; REQ: 2	<b>AVX 13 x 1450 TM</b>
				ALT	MTR-CODE: DHTD 825; MOD: FA 2105 DHTD; R; REQ: 2	<b>AVX 13 x 1450 TM</b>
				ALT	OE-NO.: 0293009; MOD: FA 2105 DHTD; L; REQ: 2	<b>AVX 13 x 1475 TM</b>
				ALT	MOD: FA 2105 DHTD; L	<b>2-AVX 13 x 1500 TM</b>
162-167 kW		DHT 825		AC-C	MTR-CODE: DHT 825; OE-NO.: 0283164; MOD: FA 2105 DHT; L; REQ: 2	<b>AVX 13 x 1450 TM</b>
				ALT	MTR-CODE: DHT 825; MOD: FA 2105 DHT; R; REQ: 2	<b>AVX 13 x 1450 TM</b>
				ALT	OE-NO.: 0293009; MOD: FA 2105 DHT; L; REQ: 2	<b>AVX 13 x 1475 TM</b>
				ALT	MOD: FA 2105 DHT; L	<b>2-AVX 13 x 1500 TM</b>

**F 2500**

<b>2500</b>						
8250 ccm	184-195 kW	DHS 825	02.82 - 09.86	1. ALT	MOD: FA 2500 DHS; REQ: 2	<b>AVX 13 x 1450 TM</b>
				2. ALT	MOD: FA 2500 DHS	<b>AVX 13 x 1600 TM</b>
				AC-C	MOD: FA 2500 DHS	<b>AVX 13 x 1050 TM</b>
				1. ALT	MOD: FA 2500 DHS	<b>2-AVX 13 x 1450 TM</b>
<b>2500; 2505; 2503</b>						
8250 ccm	184-195 kW	DHS 825	06.86 - 08.91	1. ALT	MOD: FA 2500 DHS; REQ: 2	<b>AVX 13 x 1450 TM</b>
				2. ALT	MOD: FA 2500 DHS	<b>AVX 13 x 1600 TM</b>
				AC-C	MOD: FA 2500 DHS	<b>AVX 13 x 1050 TM</b>
				1. ALT	MOD: FA 2500 DHS	<b>2-AVX 13 x 1450 TM</b>
<b>2505</b>						
8250 ccm	184-195 kW	DHS 825	06.86 - 08.91	1. ALT	MOD: FA 2500 DHS; REQ: 2	<b>AVX 13 x 1450 TM</b>
				2. ALT	MOD: FA 2500 DHS	<b>AVX 13 x 1600 TM</b>
				AC-C	MOD: FA 2500 DHS	<b>AVX 13 x 1050 TM</b>
				1. ALT	MOD: FA 2500 DHS	<b>2-AVX 13 x 1450 TM</b>
<b>2505; 2503</b>						
8250 ccm	184-195 kW	DHS 825	02.82 - 09.86	1. ALT	MOD: FA 2500 DHS; REQ: 2	<b>AVX 13 x 1450 TM</b>
				2. ALT	MOD: FA 2500 DHS	<b>AVX 13 x 1600 TM</b>
				AC-C	MOD: FA 2500 DHS	<b>AVX 13 x 1050 TM</b>
				1. ALT	MOD: FA 2500 DHS	<b>2-AVX 13 x 1450 TM</b>
<b>2525</b>						
8250 ccm	184-195 kW	DHS 825	02.82 - 08.91	1. ALT	MOD: FA 2500 DHS; REQ: 2	<b>AVX 13 x 1450 TM</b>
	184 kW			1. ALT	MOD: FA 2500 DHS; REQ: 2	<b>AVX 13 x 1450 TM</b>
				2. ALT	MOD: FA 2500 DHS	<b>AVX 13 x 1600 TM</b>
	184-195 kW			2. ALT	MOD: FA 2500 DHS	<b>AVX 13 x 1600 TM</b>
				AC-C	MOD: FA 2500 DHS	<b>AVX 13 x 1050 TM</b>
	184 kW			AC-C	MOD: FA 2500 DHS	<b>AVX 13 x 1050 TM</b>
				1. ALT	MOD: FA 2500 DHS	<b>2-AVX 13 x 1450 TM</b>
	184-195 kW			1. ALT	MOD: FA 2500 DHS	<b>2-AVX 13 x 1450 TM</b>
<b>2525; 2535</b>						
8250 ccm	184-195 kW	DHS 825	06.86 - 08.91	1. ALT	MOD: FA 2500 DHS; REQ: 2	<b>AVX 13 x 1450 TM</b>
				2. ALT	MOD: FA 2500 DHS	<b>AVX 13 x 1600 TM</b>
				AC-C	MOD: FA 2500 DHS	<b>AVX 13 x 1050 TM</b>
				1. ALT	MOD: FA 2500 DHS	<b>2-AVX 13 x 1450 TM</b>
<b>2535</b>						
8250 ccm	184-195 kW	DHS 825	02.82 - 08.91	1. ALT	MOD: FA 2500 DHS; REQ: 2	<b>AVX 13 x 1450 TM</b>
	184 kW			1. ALT	MOD: FA 2500 DHS; REQ: 2	<b>AVX 13 x 1450 TM</b>
	184-195 kW			2. ALT	MOD: FA 2500 DHS	<b>AVX 13 x 1600 TM</b>

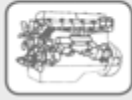

## DAF

### F 2500

#### 2535

8250 ccm	184 kW	DHS 825	02.82 - 08.91	2. ALT	MOD: FA 2500 DHS	AVX 13 x 1600 TM
				AC-C	MOD: FA 2500 DHS	AVX 13 x 1050 TM
	184-195 kW			AC-C	MOD: FA 2500 DHS	AVX 13 x 1050 TM
	184 kW			1. ALT	MOD: FA 2500 DHS	2-AVX 13 x 1450 TM
	184-195 kW			1. ALT	MOD: FA 2500 DHS	2-AVX 13 x 1450 TM

### LF 45

#### 45.150

3920 ccm	110 kW	BE 110 C	01.01 -	AC-C	MOD: FA45.150	8 PK 1515 TM
				ALT	MOD: FA45.150	8 PK 1220 TM

#### 45.170

3920 ccm	123 kW	BE 123 C	01.01 -	AC-C	MOD: FA45.170	8 PK 1515 TM
				ALT	MOD: FA45.170	8 PK 1220 TM

#### 45.180

5880 ccm	136 kW	CE 136 C	01.01 -	AC-C	MOD: FA45.180	8 PK 1515 TM
				ALT	MOD: FA45.180	8 PK 1220 TM

#### 45.220

5880 ccm	162 kW	CE 162 C	01.01 -	AC-C	MOD: 45.220;FA45.220	8 PK 1515 TM
				ALT	MOD: 45.220;FA45.220	8 PK 1220 TM

### LF 55

#### 55.170

3920 ccm	123 kW	BE 123 C	01.01 -	AC-C	MOD: FA55.170	8 PK 1515 TM
				ALT	MOD: FA55.170	8 PK 1220 TM

#### 55.180

5880 ccm	136 kW	CE 136 C	01.01 -	AC-C	MOD: FA55.180/FALF.180	8 PK 1515 TM
				ALT	MOD: FA55.180/FALF.180	8 PK 1220 TM

#### 55.220

5880 ccm	162 kW	CE 162 C	01.01 -	AC-C	MOD: FA55.220/FT55.220	8 PK 1515 TM
				ALT	MOD: FA55.220/FT55.220	8 PK 1220 TM

#### 55.250

5880 ccm	184 kW	CE 184 C	01.01 -	AC-C	MOD: FA55.250/FT55.250	8 PK 1515 TM
				ALT	MOD: FA55.250/FT55.250	8 PK 1220 TM

### N 2800

#### 2826

11600 ccm	228 kW	DKS 1160	01.81 - 09.91	ALT	MOD: NAT 2826 DKS; REQ: 2	AVX 13 x 1675 TM
-----------	--------	----------	---------------	-----	---------------------------	------------------

### N 3300

#### 3326

11600 ccm	243 kW	DKX 1160	01.81 - 09.91	AC-C	OE-NO.: 0378724; MOD: NAT 3326 DKX	AVX 13 x 1250 TM
				AC-C	OE-NO.: 0677716; MOD: NAT 3326 DKX	AVX 13 x 1325 TM
				ALT	MOD: NAT 3326 DKX; REQ: 2	AVX 13 x 1675 TM

## IVECO

### EuroCargo

#### 100.15

5861 ccm	105 kW	8060.25R.4200 LTC	01.91 -	AC-C	MOD: 100 E 15;100 E 15 K	AVX 13 x 975 TM
				AIR-C	MOD: 100 E 15;100 E 15 K; REQ: 2	AVX 13 x 1300 TM
				ALT	MOD: 100 E 15;100 E 15 K	AVX 13 x 950 TM
		8060.25R.4200 LTC;8060.45R.5000;8060.45R.50 01;8060.45R.5003;8060.45R.500 5		AC-C	MTR-CODE: 8060.25R.4200 LTC; MOD: 100 E 15;100 E 15 K	AVX 13 x 975 TM
				AIR-C	MTR-CODE: 8060.25R.4200 LTC; MOD: 100 E 15;100 E 15 K; REQ: 2	AVX 13 x 1300 TM
				ALT	MTR-CODE: 8060.25R.4200 LTC; MOD: 100 E 15;100 E 15 K	AVX 13 x 950 TM

#### 100.17

3920 ccm	125 kW	F4AE0481A	09.00 -	AC-C	MOD: 100E17Ktector	8 PK 1688 TM
				ALT	MOD: 100E17Ktector	8 PK 1230 TM

#### 100.17; 100.18

3920 ccm	125-130 kW	F4AE0481A;F4AE3481B	09.00 -	AC-C	MTR-CODE: F4AE0481A; MOD: 100E17Ktector	8 PK 1688 TM
				ALT	MTR-CODE: F4AE0481A; MOD: 100E17Ktector	8 PK 1230 TM

#### 100.18

5861 ccm	130 kW	8060.25V.4000	01.91 -	AC-C	MTR-CODE: 8060.25V.4000; MOD: 100 E 18;100 E 18 K	AVX 13 x 975 TM
----------	--------	---------------	---------	------	--	-----------------

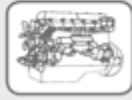
**IVECO**
**EuroCargo**

100.18						
5861 ccm	130 kW	8060.25V.4000	01.91 -	AIR-C	MTR-CODE: 8060.25V.4000; MOD: 100 E 18;100 E 18 K; REQ: 2	AVX 13 x 1300 TM
				ALT	MOD: 100 E 18;100 E 18 K; 1 ALT	AVX 13 x 950 TM
				ALT	MTR-CODE: 8060.25V.4000; MOD: 100 E 18;100 E 18 K; 1. ALT; 2 ALT	AVX 13 x 975 TM
				ALT	OE-NO.: 4732571; MOD: 100 E 18;100 E 18 K; 2. ALT; 2 ALT	AVX 13 x 1025 TM
				ALT	OE-NO.: 4749445; MOD: 100 E 18;100 E 18 K; 2. ALT; 2 ALT	AVX 13 x 1000 TM
				W-P	MTR-CODE: 8060.25V.4000; MOD: 100 E 18;100 E 18 K; REQ: 2	AVX 13 x 1300 TM
5880 ccm	134 kW	F4AE0681E		AC-C	MOD: 100E18Ktector	8 PK 1688 TM
				ALT	MOD: 100E18Ktector	8 PK 1230 TM
100.21						
5861 ccm	152 kW	8060.45.4100 TCA;8060.45.4180	01.91 -	AC-C	MTR-CODE: 8060.45.4100 TCA; MOD: 100 E 21	AVX 13 x 975 TM
				AIR-C	MTR-CODE: 8060.45.4100 TCA; MOD: 100 E 21; REQ: 2	AVX 13 x 1300 TM
				ALT	MTR-CODE: 8060.45.4100 TCA; MOD: 100 E 21	AVX 13 x 950 TM
5880 ccm	154 kW	F4AE0681D		AC-C	MOD: 100E21Ktector	8 PK 1688 TM
				ALT	MOD: 100E21Ktector	8 PK 1230 TM
120.15						
5861 ccm	105 kW	8060.25R.4200;8060.25R.4280	01.91 -	AC-C	MTR-CODE: 8060.25R 4200; MOD: 120 E 15;120 E 15 K	AVX 13 x 975 TM
				AIR-C	MTR-CODE: 8060.25R 4200; MOD: 120 E 15;120 E 15 K; REQ: 2	AVX 13 x 1300 TM
				ALT	MTR-CODE: 8060.25R 4200; MOD: 120 E 15;120 E 15 K	AVX 13 x 950 TM
		8060.25R.4280		AC-C	MTR-CODE: 8060.25R 4200; MOD: 120 E 15;120 E 15 K	AVX 13 x 975 TM
				AIR-C	MTR-CODE: 8060.25R 4200; MOD: 120 E 15;120 E 15 K; REQ: 2	AVX 13 x 1300 TM
				ALT	MTR-CODE: 8060.25R 4200; MOD: 120 E 15;120 E 15 K	AVX 13 x 950 TM
120.18						
5861 ccm	130 kW	8060.25V.4080	01.92 -	AC-C	MTR-CODE: 8060.25V.4080; MOD: 120 E 18;120 E 18 K	AVX 13 x 975 TM
				AIR-C	MTR-CODE: 8060.25V.4080; MOD: 120 E 18;120 E 18 K; REQ: 2	AVX 13 x 1300 TM
				ALT	MOD: 120 E 18;120 E 18 K; 1 ALT	AVX 13 x 950 TM
				ALT	MTR-CODE: 8060.25V.4080; MOD: 120 E 18;120 E 18 K; 1. ALT; 2 ALT	AVX 13 x 975 TM
				ALT	OE-NO.: 4732571; MOD: 120 E 18;120 E 18 K; 2. ALT; 2 ALT	AVX 13 x 1025 TM
				ALT	OE-NO.: 4749445; MOD: 120 E 18;120 E 18 K; 2. ALT; 2 ALT	AVX 13 x 1000 TM
				W-P	MTR-CODE: 8060.25V.4080; MOD: 120 E 18;120 E 18 K; REQ: 2	AVX 13 x 1300 TM
		8060.25V.4080;8060.45B.5100		AC-C	MTR-CODE: 8060.25V.4080; MOD: 120 E 18;120 E 18 K	AVX 13 x 975 TM
				AIR-C	MTR-CODE: 8060.25V.4080; MOD: 120 E 18;120 E 18 K; REQ: 2	AVX 13 x 1300 TM
				ALT	MOD: 120 E 18;120 E 18 K; 1 ALT	AVX 13 x 950 TM
				ALT	MTR-CODE: 8060.25V.4080; MOD: 120 E 18;120 E 18 K; 1. ALT; 2 ALT	AVX 13 x 975 TM
				ALT	OE-NO.: 4732571; MOD: 120 E 18;120 E 18 K; 2. ALT; 2 ALT	AVX 13 x 1025 TM
				ALT	OE-NO.: 4749445; MOD: 120 E 18;120 E 18 K; 2. ALT; 2 ALT	AVX 13 x 1000 TM
				W-P	MTR-CODE: 8060.25V.4080; MOD: 120 E 18;120 E 18 K; REQ: 2	AVX 13 x 1300 TM
5880 ccm	134 kW	F4AE0681D;F4AE0681E		AC-C	MOD: 120E18Ktector	8 PK 1688 TM
				ALT	MOD: 120E18Ktector	8 PK 1230 TM
		F4AE0681E		AC-C	MOD: 120E18Ktector	8 PK 1688 TM
				ALT	MOD: 120E18Ktector	8 PK 1230 TM
120.23						
5861 ccm	167 kW	8060.45.6090;8060.45S.6800;8060.45S.7200	01.92 -	AC-C	MTR-CODE: 8060.45.6090; MOD: 120 E 23; LHD	AVX 13 x 975 TM
				AC-C	MTR-CODE: 8060.45.6090; MOD: 120 E 23; RHD	AVX 13 x 1150 TM
				ALT	MTR-CODE: 8060.45.6090; MOD: 120 E 23; - AMP: 35	AVX 13 x 1225 TM



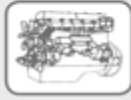

## IVECO

### EuroCargo

#### 120.23

5861 ccm 167 kW 8060.45.6090;8060.45S.6800;80 01.92 - HYD-P MTR-CODE: 8060.45.6090; AMP: 35; MOD: 120 E 23 **AVX 13 x 1200 TM**

#### 120.24

5880 ccm 176 kW F4AE0681B 09.00 - AC-C MOD: 120E24Ktector **8 PK 1688 TM**  
ALT MOD: 120E24Ktector **8 PK 1230 TM**

#### 120.24; 120.25

5880 ccm 176-185 kW F4AE0681B;F4AE3681D 09.00 - AC-C MTR-CODE: F4AE0681B; MOD: 120E24Ktector **8 PK 1688 TM**  
ALT MTR-CODE: F4AE0681B; MOD: 120E24Ktector **8 PK 1230 TM**

#### 120.28

5880 ccm 202-205 kW F4AE0681A;F4AE3681E 09.00 - AC-C MTR-CODE: F4AE0681A; MOD: 120E28tector **8 PK 1688 TM**  
ALT MTR-CODE: F4AE0681A; MOD: 120E28tector **8 PK 1230 TM**

#### 130.15

5861 ccm 105 kW 8060.25R.4280 01.94 - AC-C MOD: 130 E 15;130 E 15 K **AVX 13 x 975 TM**  
AIR-C MOD: 130 E 15;130 E 15 K; REQ: 2 **AVX 13 x 1300 TM**  
ALT MOD: 130 E 15;130 E 15 K **AVX 13 x 950 TM**

#### 130.18

5861 ccm 130 kW 8060.25V.4080 01.92 - AC-C MTR-CODE: 8060.25V.4080; MOD: 130 E 18;130 E 18 K **AVX 13 x 975 TM**  
AIR-C MTR-CODE: 8060.25V.4080; MOD: 130 E 18;130 E 18 K; REQ: 2 **AVX 13 x 1300 TM**  
ALT MOD: 130 E 18;130 E 18 K; 1 ALT **AVX 13 x 950 TM**  
ALT MTR-CODE: 8060.25V.4080; MOD: 130 E 18;130 E 18 K; 1. ALT; 2 ALT **AVX 13 x 975 TM**  
ALT OE-NO.: 4732571; MOD: 130 E 18;130 E 18 K; 2. ALT; 2 ALT **AVX 13 x 1025 TM**  
ALT OE-NO.: 4749445; MOD: 130 E 18;130 E 18 K; 2. ALT; 2 ALT **AVX 13 x 1000 TM**  
W-P MTR-CODE: 8060.25V.4080; MOD: 130 E 18;130 E 18 K; REQ: 2 **AVX 13 x 1300 TM**

5880 ccm 134 kW F4AE0681D;F4AE0681E AC-C MOD: 130E18tector **8 PK 1688 TM**  
AC-C MOD: 130E21tector **8 PK 1688 TM**  
ALT MOD: 130E18tector **8 PK 1230 TM**  
ALT MOD: 130E21tector **8 PK 1230 TM**

#### 130.23

5861 ccm 167 kW 8060.45.6090;8060.45S.6000 01.92 - AC-C MTR-CODE: 8060.45.6090; MOD: 130 E 23; LHD **AVX 13 x 975 TM**  
AC-C MTR-CODE: 8060.45.6090; MOD: 130 E 23; RHD **AVX 13 x 1150 TM**  
ALT MTR-CODE: 8060.45.6090; MOD: 130 E 23; - AMP: 35 **AVX 13 x 1225 TM**  
HYD-P MTR-CODE: 8060.45.6090; AMP: 35; MOD: 130 E 23 **AVX 13 x 1200 TM**

#### 130.24

5880 ccm 176 kW F4AE0681B 09.00 - AC-C MOD: 130E24Ktector **8 PK 1688 TM**  
ALT MOD: 130E24Ktector **8 PK 1230 TM**

#### 130.28

5880 ccm 202 kW F4AE0681A 09.00 - AC-C MOD: 130E28Ktector **8 PK 1688 TM**  
ALT MOD: 130E28Ktector **8 PK 1230 TM**

#### 135.18

5861 ccm 130 kW 8060.25V.4800 01.93 - AC-C MTR-CODE: 8060.25V.4800; MOD: 135 E 18 W **AVX 13 x 975 TM**  
AIR-C MTR-CODE: 8060.25V.4800; MOD: 135 E 18 W; REQ: 2 **AVX 13 x 1300 TM**  
ALT MOD: 135 E 18 W; 1 ALT **AVX 13 x 950 TM**  
ALT MTR-CODE: 8060.25V.4800; MOD: 135 E 18 W; 1. ALT; 2 ALT **AVX 13 x 975 TM**  
ALT OE-NO.: 4732571; MOD: 135 E 18 W; 2. ALT; 2 ALT **AVX 13 x 1025 TM**  
ALT OE-NO.: 4749445; MOD: 135 E 18 W; 2. ALT; 2 ALT **AVX 13 x 1000 TM**  
W-P MTR-CODE: 8060.25V.4800; MOD: 135 E 18 W; REQ: 2 **AVX 13 x 1300 TM**

#### 135.23

5861 ccm 167 kW 8060.45S TCA 01.93 - AC-C MOD: 135 E 23 W; LHD **AVX 13 x 975 TM**  
AC-C MOD: 135 E 23 W; RHD **AVX 13 x 1150 TM**  
ALT AMP: 35; MOD: 135 E 23 W **AVX 13 x 1200 TM**  
ALT MOD: 135 E 23 W; - AMP: 35 **AVX 13 x 1225 TM**

#### 140.18

5880 ccm 134 kW F4AE0681E 09.00 - AC-C MOD: 140E18Wtector **8 PK 1688 TM**  
ALT MOD: 140E18Wtector **8 PK 1230 TM**

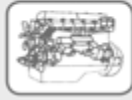
**IVECO**
**EuroCargo**

<b>140.24</b>						
5880 ccm	176 kW	F4AE0681B	09.00 -	AC-C ALT	MOD: 140E21Wtector MOD: 140E21Wtector	8 PK 1688 TM 8 PK 1230 TM
<b>150.15</b>						
5861 ccm	105 kW	8060.25R.4280	01.92 - 12.96	AC-C AIR-C ALT	MOD: 150 E 15;150 E 15 K MOD: 150 E 15;150 E 15 K; REQ: 2 MOD: 150 E 15;150 E 15 K	AVX 13 x 975 TM AVX 13 x 1300 TM AVX 13 x 950 TM
<b>150.18</b>						
5861 ccm	130 kW	8060.25V.4000;8060.25V.4080	01.92 -	AC-C	MTR-CODE: 8060.25V.4000; MOD: 150 E 18;150 E 18 K	AVX 13 x 975 TM
				AIR-C	MTR-CODE: 8060.25V.4000; MOD: 150 E 18;150 E 18 K; REQ: 2	AVX 13 x 1300 TM
				ALT	MTR-CODE: 8060.25V.4000; MOD: 150 E 18;150 E 18 K; 1 ALT	AVX 13 x 950 TM
				ALT	MTR-CODE: 8060.25V.4000; MOD: 150 E 18;150 E 18 K; 1. ALT; 2 ALT	AVX 13 x 975 TM
				ALT	MTR-CODE: 8060.25V.4000; OE-NO.: 4732571; MOD: 150 E 18;150 E 18 K; 2. ALT; 2 ALT	AVX 13 x 1025 TM
				ALT	MTR-CODE: 8060.25V.4000; OE-NO.: 4749445; MOD: 150 E 18;150 E 18 K; 2. ALT; 2 ALT	AVX 13 x 1000 TM
				W-P	MTR-CODE: 8060.25V.4000; MOD: 150 E 18;150 E 18 K; REQ: 2	AVX 13 x 1300 TM
		8060.25V.4000;8060.25V.4080;8060.45B		AC-C	MTR-CODE: 8060.25V.4000; MOD: 150 E 18;150 E 18 K	AVX 13 x 975 TM
				AIR-C	MTR-CODE: 8060.25V.4000; MOD: 150 E 18;150 E 18 K; REQ: 2	AVX 13 x 1300 TM
				ALT	MTR-CODE: 8060.25V.4000; MOD: 150 E 18;150 E 18 K; 1 ALT	AVX 13 x 950 TM
				ALT	MTR-CODE: 8060.25V.4000; MOD: 150 E 18;150 E 18 K; 1. ALT; 2 ALT	AVX 13 x 975 TM
				ALT	MTR-CODE: 8060.25V.4000; OE-NO.: 4732571; MOD: 150 E 18;150 E 18 K; 2. ALT; 2 ALT	AVX 13 x 1025 TM
				ALT	MTR-CODE: 8060.25V.4000; OE-NO.: 4749445; MOD: 150 E 18;150 E 18 K; 2. ALT; 2 ALT	AVX 13 x 1000 TM
				W-P	MTR-CODE: 8060.25V.4000; MOD: 150 E 18;150 E 18 K; REQ: 2	AVX 13 x 1300 TM
5880 ccm	134 kW	F4AE0681E		AC-C ALT	MOD: 150E18Ktector MOD: 150E18Ktector	8 PK 1688 TM 8 PK 1230 TM
<b>150.23</b>						
5861 ccm	167 kW	8060.45.6090;8060.45S.6800	01.92 -	AC-C AC-C	MTR-CODE: 8060.45.6090; MOD: 150 E 23; LHD MTR-CODE: 8060.45.6090; MOD: 150 E 23; RHD	AVX 13 x 975 TM AVX 13 x 1150 TM
				ALT	MTR-CODE: 8060.45.6090; AMP: 35; MOD: 150 E 23	AVX 13 x 1200 TM
				ALT	MTR-CODE: 8060.45.6090; MOD: 150 E 23; - AMP: 35	AVX 13 x 1225 TM
<b>150.24</b>						
5880 ccm	176 kW	F4AE0681B	09.00 -	AC-C ALT	MOD: 150E24Ktector MOD: 150E24Ktector	8 PK 1688 TM 8 PK 1230 TM
<b>150.24; 150.25</b>						
5880 ccm	176-185 kW	F4AE0681B;F4AE3681D	09.00 -	AC-C ALT	MTR-CODE: F4AE0681B; MOD: 150E24Ktector MTR-CODE: F4AE0681B; MOD: 150E24Ktector	8 PK 1688 TM 8 PK 1230 TM
<b>150.27; 150.E27FP</b>						
7685 ccm	196 kW	8360.46.417 TCA	01.92 -	AC-C	MTR-CODE: OM-8360.46.417 TCA; MOD: 150 E 27 R	AVX 13 x 1150 TM
				ALT	MTR-CODE: OM-8360.46.417 TCA; MOD: 150 E 27 R	AVX 13 x 1300 TM
<b>150.28</b>						
5880 ccm	202-205 kW	F4AE0681A;F4AE3681E	09.00 -	AC-C ALT	MTR-CODE: F4AE0681A; MOD: 150E28Ktector MTR-CODE: F4AE0681A; MOD: 150E28Ktector	8 PK 1688 TM 8 PK 1230 TM
<b>170.18; 180.18</b>						
5861 ccm	130 kW	8060.25V.4800	01.94 -	AC-C AIR-C ALT ALT ALT ALT W-P	MTR-CODE: 8060.25V.4800 MTR-CODE: 8060.25V.4800; REQ: 2 1 ALT MTR-CODE: 8060.25V.4800; 1. ALT; 2 ALT OE-NO.: 4732571; 2. ALT; 2 ALT OE-NO.: 4749445; 2. ALT; 2 ALT MTR-CODE: 8060.25V.4800; REQ: 2	AVX 13 x 975 TM AVX 13 x 1300 TM AVX 13 x 950 TM AVX 13 x 975 TM AVX 13 x 1025 TM AVX 13 x 1000 TM AVX 13 x 1300 TM
<b>170.23; 180.23</b>						
5816 ccm	167 kW	8060.45S TCA	01.94 -	AC-C	LHD	AVX 13 x 975 TM

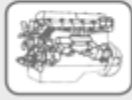

## IVECO

### EuroCargo

#### 170.23; 180.23

5816 ccm	167 kW	8060.45S TCA	01.94 -	AC-C ALT ALT	RHD - AMP: 35 AMP: 35	AVX 13 x 1150 TM AVX 13 x 1225 TM AVX 13 x 1200 TM
----------	--------	--------------	---------	--------------------	-----------------------------	--

#### 170.27; 180.27

7685 ccm	196 kW	8360.46.417 TCA	01.94 -	AC-C ALT	MTR-CODE: OM-8360.46.417 TCA; MOD: 170 E 27;180 E 27 MTR-CODE: OM-8360.46.417 TCA; MOD: 170 E 27;180 E 27	AVX 13 x 1150 TM AVX 13 x 1300 TM
----------	--------	-----------------	---------	-------------	--	--------------------------------------

#### 180.21

5861 ccm	152 kW	8060.45.4100 TCA	01.91 -	AC-C AIR-C ALT	MOD: 180 E 21 T MOD: 180 E 21 T; REQ: 2 MOD: 180 E 21 T	AVX 13 x 975 TM AVX 13 x 1300 TM AVX 13 x 950 TM
5880 ccm	154 kW	F4AE0681D		AC-C ALT	MOD: 180E21Ktector MOD: 180E21Ktector	8 PK 1688 TM 8 PK 1230 TM

#### 180.24

5880 ccm	176 kW	F4AE0681B	09.00 -	AC-C ALT	MOD: 180E24;Ptector MOD: 180E24;Ptector	8 PK 1688 TM 8 PK 1230 TM
----------	--------	-----------	---------	-------------	--	------------------------------

#### 180.24; 180.25

5880 ccm	176-185 kW	F4AE0681B;F4AE3681D	09.00 -	AC-C ALT	MTR-CODE: F4AE0681B; MOD: 180E24;Ptector MTR-CODE: F4AE0681B; MOD: 180E24;Ptector	8 PK 1688 TM 8 PK 1230 TM
----------	------------	---------------------	---------	-------------	--	------------------------------

#### 180.28

5880 ccm	202-205 kW	F4AE0681A;F4AE3681E	09.00 -	AC-C ALT	MTR-CODE: F4AE0681A; MOD: 180E28Ktector MTR-CODE: F4AE0681A; MOD: 180E28Ktector	8 PK 1688 TM 8 PK 1230 TM
----------	------------	---------------------	---------	-------------	--	------------------------------

#### 260.23

5861 ccm	167 kW	8060.45S TCA;8060.45S.6000	01.91 -	AC-C AC-C ALT ALT	MOD: 260 E 23 T; LHD MOD: 260 E 23 T; RHD AMP: 35; MOD: 260 E 23 T MOD: 260 E 23 T; - AMP: 35	AVX 13 x 975 TM AVX 13 x 1150 TM AVX 13 x 1200 TM AVX 13 x 1225 TM
----------	--------	----------------------------	---------	----------------------------	--	---

#### 280.23

5861 ccm	167 kW	8060.45S.6000	01.91 -	AC-C AC-C ALT ALT	MOD: 280 E 23 T; LHD MOD: 280 E 23 T; RHD AMP: 35; MOD: 280 E 23 T MOD: 280 E 23 T; - AMP: 35	AVX 13 x 975 TM AVX 13 x 1150 TM AVX 13 x 1200 TM AVX 13 x 1225 TM
----------	--------	---------------	---------	----------------------------	--	---

#### 320.27

7685 ccm	196 kW	8360.46.417	01.91 -	AC-C ALT	MTR-CODE: OM-8360.46.417; MOD: 320 E 27 T MTR-CODE: OM-8360.46.417; MOD: 320 E 27 T	AVX 13 x 1150 TM AVX 13 x 1300 TM
----------	--------	-------------	---------	-------------	--	--------------------------------------

#### 320.28

5880 ccm	202 kW	F4AE0681A	01.91 -	AC-C ALT	MOD: 320E28Ttector MOD: 320E28Ttector	8 PK 1688 TM 8 PK 1230 TM
----------	--------	-----------	---------	-------------	--	------------------------------

#### 60.10

3908 ccm	75 kW	8040.25B.4200	01.91 - 08.96	AC-C AIR-C ALT	MOD: 60 E 10 MOD: 60 E 10; REQ: 2 MOD: 60 E 10	AVX 13 x 975 TM AVX 13 x 1300 TM AVX 13 x 950 TM
----------	-------	---------------	---------------	----------------------	--	--

#### 60.12

3908 ccm	85 kW	8040.25X.4000	01.91 - 12.96	AC-C AIR-C ALT	MOD: 60 E 12 MOD: 60 E 12; REQ: 2 MOD: 60 E 12	AVX 13 x 975 TM AVX 13 x 1300 TM AVX 13 x 950 TM
----------	-------	---------------	---------------	----------------------	--	--

#### 60.14

3908 ccm	100 kW	8040.45.4000	01.91 -	AC-C AIR-C ALT	MOD: 60 E 14;60 E 14 K MOD: 60 E 14;60 E 14 K; REQ: 2 MOD: 60 E 14;60 E 14 K	AVX 13 x 975 TM AVX 13 x 1300 TM AVX 13 x 950 TM
----------	--------	--------------	---------	----------------------	--	--

#### 65.10

3908 ccm	75 kW	8040.25B.4200	01.91 - 12.96	AC-C AIR-C ALT	MOD: 65 E 10;65 E 10 K MOD: 65 E 10;65 E 10 K; REQ: 2 MOD: 65 E 10;65 E 10 K	AVX 13 x 975 TM AVX 13 x 1300 TM AVX 13 x 950 TM
----------	-------	---------------	---------------	----------------------	--	--

#### 65.12

3908 ccm	85 kW	8040.25X.4000	01.91 -	AC-C AIR-C ALT	MOD: 65 E 12;65 E 12 K MOD: 65 E 12;65 E 12 K; REQ: 2 MOD: 65 E 12;65 E 12 K	AVX 13 x 975 TM AVX 13 x 1300 TM AVX 13 x 950 TM
----------	-------	---------------	---------	----------------------	--	--

#### 65.13

3920 ccm	95 kW	F4AE0481D	09.00 -	AC-C AC-C ALT ALT	MOD: 75E13tector MOD: tector65E13 MOD: 75E13tector MOD: tector65E13	8 PK 1688 TM 8 PK 1688 TM 8 PK 1230 TM 8 PK 1230 TM
----------	-------	-----------	---------	----------------------------	--	--



## IVECO

### EuroCargo

<b>65.15</b>						
3920 ccm	110 kW	F4AE0481C	09.00 -	AC-C ALT	MOD: 65E15tector MOD: 65E15tector	8 PK 1688 TM 8 PK 1230 TM
<b>75.12</b>						
3908 ccm	85 kW	8040.25X.4000	01.91 -	AC-C AIR-C ALT	MOD: 75 E 12;75 E 12 K MOD: 75 E 12;75 E 12 K; REQ: 2 MOD: 75 E 12;75 E 12 K	AVX 13 x 975 TM AVX 13 x 1300 TM AVX 13 x 950 TM
<b>75.13</b>						
3920 ccm	95 kW	F4AE0481D	09.00 -	AC-C ALT	MOD: 75E13tector MOD: 75E13tector	8 PK 1688 TM 8 PK 1230 TM
<b>75.14</b>						
3908 ccm	100 kW	8040.45.4000;8040.45.4180	01.91 -	AC-C AIR-C ALT	MTR-CODE: 8040.45.4000; MOD: 75 E 14;75 E 14 K MTR-CODE: 8040.45.4000; MOD: 75 E 14;75 E 14 K; REQ: 2 MTR-CODE: 8040.45.4000; MOD: 75 E 14;75 E 14 K	AVX 13 x 975 TM AVX 13 x 1300 TM AVX 13 x 950 TM
<b>75.15</b>						
5861 ccm	105 kW	8060.25R.4200 LTC	01.91 -	AC-C AIR-C ALT	MOD: 75 E 15 K MOD: 75 E 15 K; REQ: 2 MOD: 75 E 15 K	AVX 13 x 975 TM AVX 13 x 1300 TM AVX 13 x 950 TM
3920 ccm	110 kW	F4AE0481C		AC-C ALT	MOD: 75E15Ktector MOD: 75E15Ktector	8 PK 1688 TM 8 PK 1230 TM
<b>75.15; 80.15</b>						
5861 ccm	105 kW	8060.25R.4200 LTC	01.91 - 09.00	AC-C AIR-C ALT	FROM: 01.91; UNTIL: 09.00; MOD: 75 E 15 K FROM: 01.91; UNTIL: 09.00; MOD: 75 E 15 K; REQ: 2 FROM: 01.91; UNTIL: 09.00; MOD: 75 E 15 K	AVX 13 x 975 TM AVX 13 x 1300 TM AVX 13 x 950 TM
<b>75.17; 75.18</b>						
3920 ccm	125-130 kW	F4AE0481A;F4AE3481B	09.00 -	AC-C AC-C ALT ALT	MTR-CODE: F4AE0481A; MOD: 120E17Ktector MTR-CODE: F4AE0481A; MOD: 75E17Ktector MTR-CODE: F4AE0481A; MOD: 120E17Ktector MTR-CODE: F4AE0481A; MOD: 75E17Ktector	8 PK 1688 TM 8 PK 1688 TM 8 PK 1230 TM 8 PK 1230 TM
<b>75.18</b>						
5880 ccm	134 kW	F4AE0681D;F4AE0681E F4AE0681E	09.00 -	AC-C ALT AC-C ALT	MOD: 75E18Ktector MOD: 75E18Ktector MOD: 75E18Ktector MOD: 75E18Ktector	8 PK 1688 TM 8 PK 1230 TM 8 PK 1688 TM 8 PK 1230 TM
<b>80.15</b>						
5861 ccm	105 kW	8060.25R.4200 LTC	01.91 -	AC-C AC-C AIR-C AIR-C ALT ALT	MTR-CODE: 8060.25R.4200 LTC; MOD: 80 E 15;80 E 15 K MTR-CODE: 8060.25R; MOD: 170 E 15 MTR-CODE: 8060.25R.4200 LTC; MOD: 80 E 15;80 E 15 K; REQ: 2 MTR-CODE: 8060.25R; MOD: 170 E 15; REQ: 2 MTR-CODE: 8060.25R.4200 LTC; MOD: 80 E 15;80 E 15 K MTR-CODE: 8060.25R; MOD: 170 E 15	AVX 13 x 975 TM AVX 13 x 975 TM AVX 13 x 1300 TM AVX 13 x 950 TM AVX 13 x 950 TM
3920 ccm	110 kW	F4AE0481C		AC-C ALT	MOD: 80EL15tector MOD: 80EL15tector	8 PK 1688 TM 8 PK 1230 TM
<b>80.17; 80.18</b>						
3920 ccm	125-130 kW	F4AE0481A;F4AE3481B	09.00 -	AC-C ALT	MTR-CODE: F4AE0481A; MOD: 80E17K MTR-CODE: F4AE0481A; MOD: 80E17K	8 PK 1688 TM 8 PK 1230 TM
<b>80.18</b>						
5861 ccm	130 kW	8060.25V.4000	01.91 -	AC-C AIR-C ALT ALT ALT ALT W-P	MTR-CODE: 8060.25V.4000; MOD: 80 E 18;80 E 18 K MTR-CODE: 8060.25V.4000; MOD: 80 E 18;80 E 18 K; REQ: 2 MOD: 80 E 18;80 E 18 K; 1 ALT MTR-CODE: 8060.25V.4000; MOD: 80 E 18;80 E 18 K; 1. ALT; 2 ALT OE-NO.: 4732571; MOD: 80 E 18;80 E 18 K; 2. ALT; 2 ALT OE-NO.: 4749445; MOD: 80 E 18;80 E 18 K; 2. ALT; 2 ALT MTR-CODE: 8060.25V.4000; MOD: 80 E 18;80 E 18 K; REQ: 2	AVX 13 x 975 TM AVX 13 x 1300 TM AVX 13 x 950 TM AVX 13 x 975 TM AVX 13 x 1025 TM AVX 13 x 1000 TM AVX 13 x 1300 TM
5880 ccm	134 kW	F4AE0681D;F4AE0681E		AC-C ALT	MOD: 80E18Ktector MOD: 80E18Ktector	8 PK 1688 TM 8 PK 1230 TM

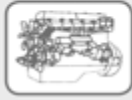

## IVECO

### EuroCargo

#### 80.18

5880 ccm	134 kW	F4AE0681E	01.91 -	AC-C	MOD: 80E18Ktector	<b>8 PK 1688 TM</b>
				ALT	MOD: 80E18Ktector	<b>8 PK 1230 TM</b>

#### 80.18; 18.80

5861 ccm	130 kW	8060.25V.4000	01.91 -	AC-C	MTR-CODE: 8060.25V.4000; MOD: 80 E 18;80 E 18 K	<b>AVX 13 x 975 TM</b>
				AIR-C	MTR-CODE: 8060.25V.4000; MOD: 80 E 18;80 E 18 K; REQ: 2	<b>AVX 13 x 1300 TM</b>
				ALT	MOD: 80 E 18;80 E 18 K; 1 ALT	<b>AVX 13 x 950 TM</b>
				ALT	MTR-CODE: 8060.25V.4000; MOD: 80 E 18;80 E 18 K; 1. ALT; 2 ALT	<b>AVX 13 x 975 TM</b>
				ALT	OE-NO.: 4732571; MOD: 80 E 18;80 E 18 K; 2. ALT; 2 ALT	<b>AVX 13 x 1025 TM</b>
				ALT	OE-NO.: 4749445; MOD: 80 E 18;80 E 18 K; 2. ALT; 2 ALT	<b>AVX 13 x 1000 TM</b>
				W-P	MTR-CODE: 8060.25V.4000; MOD: 80 E 18;80 E 18 K; REQ: 2	<b>AVX 13 x 1300 TM</b>

#### 80.21

5861 ccm	152 kW	8060.45.4100 TCA;8060.45.4180	01.91 -	AC-C	MTR-CODE: 8060.45.4100 TCA; MOD: 80 E 21	<b>AVX 13 x 975 TM</b>
				AIR-C	MTR-CODE: 8060.45.4100 TCA; MOD: 80 E 21; REQ: 2	<b>AVX 13 x 1300 TM</b>
				ALT	MTR-CODE: 8060.45.4100 TCA; MOD: 80 E 21	<b>AVX 13 x 950 TM</b>

#### 80.21; 21.80

5861 ccm	152 kW	8060.45.4100 TCA;8060.45.4180	01.91 -	AC-C	MTR-CODE: 8060.45.4100 TCA; MOD: 80 E 21	<b>AVX 13 x 975 TM</b>
				AIR-C	MTR-CODE: 8060.45.4100 TCA; MOD: 80 E 21; REQ: 2	<b>AVX 13 x 1300 TM</b>
				ALT	MTR-CODE: 8060.45.4100 TCA; MOD: 80 E 21	<b>AVX 13 x 950 TM</b>

#### 80.21; 80.22

5880 ccm	154-160 kW	F4AE0681D;F4AE3681B	09.00 -	AC-C	MTR-CODE: F4AE0681D; MOD: 80E21Ktector	<b>8 PK 1688 TM</b>
				ALT	MTR-CODE: F4AE0681D; MOD: 80E21Ktector	<b>8 PK 1230 TM</b>

#### 90.17

3920 ccm	125 kW	F4AE0481A	09.00 -	AC-C	MOD: 90E17Ktector	<b>8 PK 1688 TM</b>
				ALT	MOD: 90E17Ktector	<b>8 PK 1230 TM</b>

#### 90.17; 90.17D; 90.18

3920 ccm	125-130 kW	F4AE0481A;F4AE3481B	09.00 -	AC-C	MTR-CODE: F4AE0481A; MOD: 90E17Ktector	<b>8 PK 1688 TM</b>
				ALT	MTR-CODE: F4AE0481A; MOD: 90E17Ktector	<b>8 PK 1230 TM</b>

#### 90.18

5880 ccm	130-134 kW	F4AE0681E	09.00 -	AC-C	MOD: 90E18Ktector	<b>8 PK 1688 TM</b>
				ALT	MOD: 90E18Ktector	<b>8 PK 1230 TM</b>
	134 kW			AC-C	MOD: 90E18Ktector	<b>8 PK 1688 TM</b>
				ALT	MOD: 90E18Ktector	<b>8 PK 1230 TM</b>

#### 90.21

5880 ccm	154 kW	F4AE0681D	09.00 -	AC-C	MOD: 90E21Ktector	<b>8 PK 1688 TM</b>
				ALT	MOD: 90E21Ktector	<b>8 PK 1230 TM</b>

#### 90.21; 90.22

5880 ccm	154-160 kW	F4AE0681D;F4AE3681B	09.00 -	AC-C	MTR-CODE: F4AE0681D; MOD: 90E21Ktector	<b>8 PK 1688 TM</b>
				ALT	MTR-CODE: F4AE0681D; MOD: 90E21Ktector	<b>8 PK 1230 TM</b>

#### 95.15

5861 ccm	105 kW	8060.25R.4750;8060.25R.4755;8060.25R.4760;8060.25R.4764;8060.45R.5050;8060.45R.5051	11.93 -	AC-C	MTR-CODE: 8060.25R.4750; MOD: 95 E 15 W	<b>AVX 13 x 975 TM</b>
				AIR-C	MTR-CODE: 8060.25R.4750; MOD: 95 E 15 W; REQ: 2	<b>AVX 13 x 1300 TM</b>
				ALT	MTR-CODE: 8060.25R.4750; MOD: 95 E 15 W	<b>AVX 13 x 950 TM</b>

#### 95.21

5861 ccm	152 kW	8060.45.4700;8060.45.4702;8060.45.4704;8060.45.4706;8060.45.4708;8060.45.5250;8060.45.5251;8060.45.5255	11.93 -	AC-C	MTR-CODE: 8060.45.4700; MOD: 95 E 21 W	<b>AVX 13 x 975 TM</b>
				AIR-C	MTR-CODE: 8060.45.4700; MOD: 95 E 21 W; REQ: 2	<b>AVX 13 x 1300 TM</b>
				ALT	MTR-CODE: 8060.45.4700; MOD: 95 E 21 W	<b>AVX 13 x 950 TM</b>

### EuroStar

#### 190.38

9500 ccm	276 kW	8460.41L TCA	01.93 - 02.02	AC-C	MOD: LD 190 E 38 P	<b>AVX 13 x 1000 TM</b>
				ALT	UNTIL MTR-NO: 443442; MOD: LD 190 E 38 P; REQ: 2	<b>AVX 13 x 1400 TM</b>

#### 190.39

10300 ccm	287 kW	F3AE0681E	11.99 - 02.02	AC-C	MOD: LD190E39P	<b>4 PK 1070 TM</b>
-----------	--------	-----------	---------------	------	----------------	---------------------



## IVECO

### EuroStar

<b>190.39</b>						
10300 ccm	287 kW	F3AE0681E	11.99 - 02.02	ALT ALT	MOD: LD190E39P	12 PK 1815 TM KT 7003
<b>190.42</b>						
13798 ccm	309 kW	8210.42L(TCA);8210.42L.400	01.93 - 02.02	AC-C ALT W-P W-P	MOD: LD 190 E 42 MOD: LD 190 E 42 FROM MTR-NO: 425086; REQ: 2 UNTIL MTR-NO: 425085; MOD: LD 190 E 42; REQ: 2	AVX 13 x 1275 TM AVX 13 x 1050 TM 17 x 1150 AVX 13 x 1200 TM
<b>190.43</b>						
10300 ccm	316 kW	F3AE0681D	11.99 - 02.02	AC-C ALT ALT	MOD: LD190E43P MOD: LD190E43P	4 PK 1070 TM 12 PK 1815 TM KT 7003
<b>190.47</b>						
13798 ccm	345 kW	8210.42M. TCA	01.93 - 02.02	AC-C ALT W-P	MOD: LD 190 E 47 MOD: LD 190 E 47 REQ: 2	AVX 13 x 1275 TM AVX 13 x 1050 TM 17 x 1150
<b>190.52</b>						
17173 ccm	378 kW	8280.42S. TCA	01.93 - 02.02	AC-C ALT FAN FAN	MOD: LD 190 E 52 MOD: LD 190 E 52 FROM MTR-NO: 307843; MOD: LD190E52 UNTIL MTR-NO: 307842; MOD: LD190E52	AVX 13 x 1325 TM AVX 13 x 1525 TM 15 PK 938 TM 15 PK 954 TM
<b>240.38</b>						
9500 ccm	276 kW	8460.41L.5020	01.93 - 02.02	AC-C ALT	MOD: LD 240 E 38 UNTIL MTR-NO: 443442; MOD: LD 240 E 38; REQ: 2	AVX 13 x 1000 TM AVX 13 x 1400 TM
<b>240.42</b>						
13798 ccm	309 kW	8210.42L(TCA);8210.42L.400	01.93 - 02.02	AC-C ALT W-P W-P	MOD: LD 240 E 42 MOD: LD 240 E 42 FROM MTR-NO: 425086; REQ: 2 UNTIL MTR-NO: 425085; MOD: LD 240 E 42; REQ: 2	AVX 13 x 1275 TM AVX 13 x 1050 TM 17 x 1150 AVX 13 x 1200 TM
<b>240.47</b>						
13798 ccm	345 kW	8210.42M. TCA	01.93 - 02.02	AC-C ALT W-P	MOD: LD 240 E 47 P MOD: LD 240 E 47 P REQ: 2	AVX 13 x 1275 TM AVX 13 x 1050 TM 17 x 1150
<b>240.52</b>						
17173 ccm	378 kW	8280.42S. TCA	01.93 - 02.02	AC-C ALT FAN FAN	MOD: LD 240 E 52 P MOD: LD 240 E 52 P FROM MTR-NO: 307843; MOD: LD240E52P UNTIL MTR-NO: 307842; MOD: LD240E52P	AVX 13 x 1325 TM AVX 13 x 1525 TM 15 PK 938 TM 15 PK 954 TM
<b>260.39</b>						
10300 ccm	287 kW	F3AE0681E	11.99 - 02.02	AC-C ALT ALT	MOD: LD260E39P MOD: LD260E39P	4 PK 1070 TM 12 PK 1815 TM KT 7003
<b>260.42</b>						
13798 ccm	309 kW	8210.42L.	01.93 - 02.02	AC-C ALT W-P W-P	MOD: LD 260 E 42 P MOD: LD 260 E 42 P FROM MTR-NO: 425086; REQ: 2 UNTIL MTR-NO: 425085; MOD: LD 260 E 42 P; REQ: 2	AVX 13 x 1275 TM AVX 13 x 1050 TM 17 x 1150 AVX 13 x 1200 TM
<b>260.43</b>						
10300 ccm	316 kW	F3AE0681D	01.93 - 02.02	AC-C ALT ALT	MOD: LD260E43Y/PS MOD: LD260E43Y/PS	4 PK 1070 TM 12 PK 1815 TM KT 7003
<b>260.47</b>						
13798 ccm	345 kW	8210.42M. TCA	01.93 - 02.02	AC-C ALT W-P	MOD: LD 260 E 47 MOD: LD 260 E 47 REQ: 2	AVX 13 x 1275 TM AVX 13 x 1050 TM 17 x 1150
<b>260.52</b>						
17173 ccm	378 kW	8280.42S. TCA	01.93 - 02.02	AC-C ALT FAN FAN	MOD: LD 260 E 52 MOD: LD 260 E 52 FROM MTR-NO: 307843; MOD: LD260E52 UNTIL MTR-NO: 307842; MOD: LD260E52	AVX 13 x 1325 TM AVX 13 x 1525 TM 15 PK 938 TM 15 PK 954 TM
<b>400.38; 440.38</b>						
9500 ccm	276 kW	8460.41L TCA;8460.41L.5020;8460.41N	01.93 - 02.02	AC-C	MTR-CODE: 8460.41L TCA	AVX 13 x 1000 TM

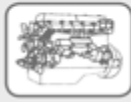

## IVECO

### EuroStar

#### 400.38; 440.38

9500 ccm 276 kW 8460.41L 01.93 - 02.02 ALT UNTIL MTR-NO: 443442; MTR-CODE: 8460.41L AVX 13 x 1400 TM  
TCA;8460.41L.5020;8460.41N TCA; REQ: 2

#### 400.42; 440.42

13798 ccm 309 kW 8210.42L. 01.93 - 02.02 AC-C AVX 13 x 1275 TM  
ALT AVX 13 x 1050 TM  
W-P FROM MTR-NO: 425086; REQ: 2 17 x 1150  
W-P UNTIL MTR-NO: 425085; REQ: 2 AVX 13 x 1200 TM

#### 440.38

9500 ccm 276 kW 8460.41L TCA;8460.41N 01.93 - 02.02 AC-C MTR-CODE: 8460.41L TCA AVX 13 x 1000 TM  
ALT UNTIL MTR-NO: 443442; MTR-CODE: 8460.41L AVX 13 x 1400 TM  
TCA; REQ: 2

#### 440.39

10300 ccm 287 kW F3AE0681E 11.99 - ALT KT 7003

#### 440.42

13798 ccm 309 kW 8210.42L(TCA);8210.42L. 01.93 - 02.02 AC-C AVX 13 x 1275 TM  
ALT AVX 13 x 1050 TM  
W-P FROM MTR-NO: 425086; REQ: 2 17 x 1150  
W-P UNTIL MTR-NO: 425085; REQ: 2 AVX 13 x 1200 TM  
8210.42L. AC-C AVX 13 x 1275 TM  
ALT AVX 13 x 1050 TM  
W-P FROM MTR-NO: 425086; REQ: 2 17 x 1150  
W-P UNTIL MTR-NO: 425085; REQ: 2 AVX 13 x 1200 TM

#### 440.43

10300 ccm 316 kW F3AE0681D 01.93 - 02.02 AC-C MOD: LD440E43TP 4 PK 1070 TM  
ALT MOD: LD440E43TP 12 PK 1815 TM  
ALT KT 7003

#### 440.47

13798 ccm 345 kW 8210.42M. TCA 01.93 - 02.02 AC-C MOD: LD 440 E 47 T AVX 13 x 1275 TM  
ALT MOD: LD 440 E 47 T AVX 13 x 1050 TM  
W-P REQ: 2 17 x 1150

#### 440.48

12880 ccm 353 kW F3BE0681E 01.01 - 02.02 AC-C MOD: LD440E48 4 PK 1070 TM  
ALT MOD: LD440E48 12 PK 1840 TM

#### 440.52

17173 ccm 378 kW 8280.42S. TCA 01.93 - 02.02 AC-C MOD: LD 440 E 52 T AVX 13 x 1325 TM  
ALT MOD: LD 440 E 52 T AVX 13 x 1525 TM  
W-P REQ: 2 17 x 1150  
FAN FROM MTR-NO: 307843; MOD: LD440E52T 15 PK 938 TM  
FAN UNTIL MTR-NO: 307842; MOD: LD440E52T 15 PK 954 TM

### EuroTech MH

#### 190.24

7790 ccm 180 kW F2BE0681D 09.98 - AC-C MOD: MH190E24 4 PK 1025 TM  
ALT MOD: MH190E24 10 PK 1725 TM

#### 190.27

7790 ccm 200 kW F2BE0681C;F2BE0681F 09.98 - AC-C MOD: MH190E27 4 PK 1025 TM  
ALT MOD: MH190E27 10 PK 1725 TM

#### 190.31

7790 ccm 228 kW F2BE0681B 09.98 - AC-C MOD: MH190E31 4 PK 1025 TM  
ALT MOD: MH190E31 10 PK 1725 TM

#### 190.35

7790 ccm 259 kW F2BE0681A 09.98 - AC-C MOD: MH190E35 4 PK 1025 TM  
ALT MOD: MH190E35 10 PK 1725 TM

#### 260.24

7790 ccm 180 kW F2BE0681D 11.99 - AC-C MOD: MH260E24Y/P 4 PK 1025 TM  
ALT MOD: MH260E24Y/P 10 PK 1725 TM

#### 260.27

7790 ccm 200 kW F2BE0681C;F2BE0681F 11.99 - AC-C MOD: MH260E27Y/P 4 PK 1025 TM  
ALT MOD: MH260E27Y/P 10 PK 1725 TM

#### 260.31

7790 ccm 228 kW F2BE0681B 11.99 - AC-C MOD: MH260E31Y/P 4 PK 1025 TM  
ALT MOD: MH260E31Y/P 10 PK 1725 TM

#### 260.35

7790 ccm 259 kW F2BE0681A 11.99 - AC-C MOD: MH260E35Y/P 4 PK 1025 TM  
ALT MOD: MH260E35Y/P 10 PK 1725 TM

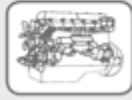

## IVECO

### EuroTech MH

#### 400.31; 440.31

7790 ccm	228 kW	F2BE0681B	09.98 -	AC-C ALT	MOD: MH440E31TP MOD: MH440E31TP	4 PK 1025 TM 10 PK 1725 TM
----------	--------	-----------	---------	-------------	------------------------------------	-------------------------------

#### 400.35; 440.35

7790 ccm	259 kW	F2BE0681A	09.98 -	AC-C ALT	MOD: MH440E35TP MOD: MH440E35TP	4 PK 1025 TM 10 PK 1725 TM
----------	--------	-----------	---------	-------------	------------------------------------	-------------------------------

### EuroTech MP

#### 180.34

9500 ccm	254 kW	8460.41K.406	01.92 - 12.93	AC-C AC-C ALT	MOD: MP 180 E 34 UNTIL MTR-NO: 449935; MTR-CODE: 8460.41K.406;EURO II; MOD: MP 180 E 34; REQ: 2 UNTIL MTR-NO: 449935; MTR-CODE: 8460.41K.406;EURO I; MOD: MP 180 E 34; REQ: 2	AVX 13 x 1000 TM AVX 13 x 1425 TM AVX 13 x 1400 TM
----------	--------	--------------	---------------	---------------------	---	--

#### 180.38

9500 ccm	276 kW	8460.41L.5020	01.92 - 12.93	AC-C AC-C ALT ALT	MOD: MP 180 E 38 UNTIL MTR-NO: 443442; MTR-CODE: 8460.41L.5020;EURO II; MOD: MP 180 E 38; REQ: 2 MOD: MP 180 E 38 UNTIL MTR-NO: 443442; MTR-CODE: 8460.41L.5020;EURO I; MOD: MP 180 E 38; REQ: 2	AVX 13 x 1000 TM AVX 13 x 1425 TM AVX 13 x 1050 TM AVX 13 x 1400 TM
----------	--------	---------------	---------------	----------------------------	---	--

#### 180.42

13798 ccm	309 kW	8210.42L.400	01.92 - 12.93	AC-C ALT W-P W-P	MOD: MP 180 E 42 MOD: MP 180 E 42 FROM MTR-NO: 425086; REQ: 2 UNTIL MTR-NO: 425085; MOD: MP 180 E 42; REQ: 2	AVX 13 x 1275 TM AVX 13 x 1050 TM 17 x 1150 AVX 13 x 1200 TM
-----------	--------	--------------	---------------	---------------------------	--	---

#### 190.34

9500 ccm	254 kW	8460.41K.406	01.93 -	AC-C AC-C ALT	MOD: MP 190 E 34 UNTIL MTR-NO: 449935; MTR-CODE: 8460.41K.406;EURO II; MOD: MP 190 E 34; REQ: 2 UNTIL MTR-NO: 449935; MTR-CODE: 8460.41K.406;EURO I; MOD: MP 190 E 34; REQ: 2	AVX 13 x 1000 TM AVX 13 x 1425 TM AVX 13 x 1400 TM
----------	--------	--------------	---------	---------------------	---	--

#### 190.38

9500 ccm	276 kW	8460.41L TCA	01.93 -	AC-C AC-C ALT ALT	MOD: MP 190 E 38 UNTIL MTR-NO: 443442; MTR-CODE: 8460.41L TCA;EURO II; MOD: MP 190 E 38; REQ: 2 MOD: MP 190 E 38 UNTIL MTR-NO: 443442; MTR-CODE: 8460.41L TCA;EURO I; MOD: MP 190 E 38; REQ: 2	AVX 13 x 1000 TM AVX 13 x 1425 TM AVX 13 x 1050 TM AVX 13 x 1400 TM
----------	--------	--------------	---------	----------------------------	---	--

#### 190.39; 190.E39

10300 ccm	287 kW	F3AE0681E	11.99 -	AC-C ALT ALT	MOD: MP190E39FP-CT MOD: MP190E39FP-CT	4 PK 1070 TM 12 PK 1815 TM KT 7003
-----------	--------	-----------	---------	--------------------	--	--

#### 190.42

13798 ccm	309 kW	8210.42L.400	01.93 -	AC-C ALT W-P W-P	MOD: MP 190 E 42 MOD: MP 190 E 42 FROM MTR-NO: 425086; REQ: 2 UNTIL MTR-NO: 425085; MOD: MP 190 E 42; REQ: 2	AVX 13 x 1275 TM AVX 13 x 1050 TM 17 x 1150 AVX 13 x 1200 TM
-----------	--------	--------------	---------	---------------------------	--	---

#### 190.43

10300 ccm	316 kW	F3AE0681D	01.01 -	AC-C ALT ALT	MOD: 190E43 MOD: 190E43	4 PK 1070 TM 12 PK 1815 TM KT 7003
-----------	--------	-----------	---------	--------------------	----------------------------	--

#### 240.30

9500 ccm	221 kW	8460.41C. TCA	01.97 -	AC-C AC-C ALT	MOD: MP 240 E 30 PS MTR-CODE: 8460.41C. TCA;EURO II; MOD: MP 240 E 30 PS; REQ: 2 MTR-CODE: 8460.41C. TCA;EURO I; MOD: MP 240 E 30 PS; REQ: 2	AVX 13 x 1000 TM AVX 13 x 1425 TM AVX 13 x 1400 TM
----------	--------	---------------	---------	---------------------	--	--

#### 240.34

9500 ccm	254 kW	8460.41K. TCA	09.95 - 12.96	AC-C AC-C	MOD: MP 240 E 34 UNTIL MTR-NO: 449935; MTR-CODE: 8460.41K. TCA;EURO II; MOD: MP 240 E 34; REQ: 2	AVX 13 x 1000 TM AVX 13 x 1425 TM
----------	--------	---------------	---------------	--------------	---	--------------------------------------



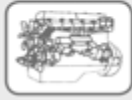

## IVECO

### EuroTech MP

#### 240.34

9500 ccm 254 kW 8460.41K.TCA 09.95 - 12.96 ALT UNTIL MTR-NO: 449935; MTR-CODE: 8460.41K.TCA;EURO I; MOD: MP 240 E 34; REQ: 2 **AVX 13 x 1400 TM**

#### 240.38

9500 ccm 276 kW 8460.41L.5020 01.92 - AC-C MOD: MP 240 E 38 **AVX 13 x 1000 TM**  
AC-C UNTIL MTR-NO: 443442; MTR-CODE: 8460.41L.5020;EURO II; MOD: MP 240 E 38; REQ: 2 **AVX 13 x 1425 TM**  
ALT MOD: MP 240 E 38 **AVX 13 x 1050 TM**  
ALT UNTIL MTR-NO: 443442; MTR-CODE: 8460.41L.5020;EURO I; MOD: MP 240 E 38; REQ: 2 **AVX 13 x 1400 TM**

#### 240.42

13798 ccm 309 kW 8210.42L.400 01.92 - AC-C MOD: MP 240 E 42 **AVX 13 x 1275 TM**  
ALT MOD: MP 240 E 42 **AVX 13 x 1050 TM**  
W-P FROM MTR-NO: 425086; REQ: 2 **17 x 1150**  
W-P UNTIL MTR-NO: 425085; MOD: MP 240 E 42; REQ: 2 **AVX 13 x 1200 TM**

#### 260.38

9500 ccm 276 kW 8460.41N 01.94 - AC-C FROM: 01.94; MOD: MP 260 E 38 P **AVX 13 x 1000 TM**  
AC-C FROM: 01.94; UNTIL MTR-NO: 443442; MTR-CODE: 8460.41N;EURO II; MOD: MP 260 E 38 P; REQ: 2 **AVX 13 x 1425 TM**  
ALT FROM: 01.94; MOD: MP 260 E 38 P **AVX 13 x 1050 TM**  
ALT FROM: 01.94; UNTIL MTR-NO: 443442; MTR-CODE: 8460.41N;EURO I; MOD: MP 260 E 38 P; REQ: 2 **AVX 13 x 1400 TM**

#### 260.39

10300 ccm 287 kW F3AE0681E 11.99 - AC-C MOD: MP260E39Y/PS **4 PK 1070 TM**  
ALT MOD: MP260E39Y/PS **12 PK 1815 TM**  
ALT **KT 7003**

#### 260.42

13798 ccm 309 kW 8210.42L.400 01.94 - AC-C MOD: MP 260 E 42 **AVX 13 x 1275 TM**  
ALT MOD: MP 260 E 42 **AVX 13 x 1050 TM**  
W-P FROM MTR-NO: 425086; REQ: 2 **17 x 1150**  
W-P UNTIL MTR-NO: 425085; MOD: MP 260 E 42; REQ: 2 **AVX 13 x 1200 TM**

#### 260.43

10300 ccm 316 kW F3AE0681D 11.99 - AC-C MOD: MP260E43Y/PS **4 PK 1070 TM**  
ALT MOD: MP260E43Y/PS **12 PK 1815 TM**  
ALT **KT 7003**

#### 400.34; 440.34

9500 ccm 254 kW 8460.41K.406 01.92 - AC-C **AVX 13 x 1000 TM**  
AC-C UNTIL MTR-NO: 449935; MTR-CODE: 8460.41K.406;EURO II; REQ: 2 **AVX 13 x 1425 TM**  
ALT UNTIL MTR-NO: 449935; MTR-CODE: 8460.41K.406;EURO I; REQ: 2 **AVX 13 x 1400 TM**

#### 400.38

9500 ccm 276 kW 8460.41L.5020;8460.41N 11.93 - 12.96 AC-C MTR-CODE: 8460.41L.5020 **AVX 13 x 1000 TM**  
AC-C UNTIL MTR-NO: 443442; MTR-CODE: 8460.41L.5020;EURO II; REQ: 2 **AVX 13 x 1425 TM**  
ALT MTR-CODE: 8460.41L.5020 **AVX 13 x 1050 TM**  
ALT UNTIL MTR-NO: 443442; MTR-CODE: 8460.41L.5020;EURO I; REQ: 2 **AVX 13 x 1400 TM**

#### 400.38; 440.38

9500 ccm 276 kW 8460.41L.5020;8460.41N 01.92 - AC-C MTR-CODE: 8460.41L.5020 **AVX 13 x 1000 TM**  
AC-C UNTIL MTR-NO: 443442; MTR-CODE: 8460.41L.5020;EURO II; REQ: 2 **AVX 13 x 1425 TM**  
ALT MTR-CODE: 8460.41L.5020 **AVX 13 x 1050 TM**  
ALT UNTIL MTR-NO: 443442; MTR-CODE: 8460.41L.5020;EURO I; REQ: 2 **AVX 13 x 1400 TM**

#### 400.42; 440.42

13798 ccm 309 kW 8210.42L(TCA);8210.42L.400 01.92 - AC-C **AVX 13 x 1275 TM**  
ALT **AVX 13 x 1050 TM**  
W-P FROM MTR-NO: 425086; REQ: 2 **17 x 1150**  
W-P UNTIL MTR-NO: 425085; REQ: 2 **AVX 13 x 1200 TM**

#### 440.38

9500 ccm 276 kW 8460.41L.TCA 01.93 - AC-C MOD: MP 440 E 38 TZ **AVX 13 x 1000 TM**



## IVECO

### EuroTech MP

<b>440.38</b>	9500 ccm	276 kW	8460.41L TCA	01.93 -	AC-C ALT ALT	UNTIL MTR-NO: 443442; MTR-CODE: 8460.41L TCA;EURO II; MOD: MP 440 E 38 TZ; REQ: 2 MOD: MP 440 E 38 TZ UNTIL MTR-NO: 443442; MTR-CODE: 8460.41L TCA;EURO I; MOD: MP 440 E 38 TZ; REQ: 2	<b>AVX 13 x 1425 TM</b> <b>AVX 13 x 1050 TM</b> <b>AVX 13 x 1400 TM</b>
<b>440.39</b>	10300 ccm	287 kW	F3AE0681E	11.99 -	AC-C ALT ALT	MOD: MP440E39TP MOD: MP440E39TP	<b>4 PK 1070 TM</b> <b>12 PK 1815 TM</b> <b>KT 7003</b>
<b>440.40</b>	10300 ccm	294 kW	F3AE0681B	09.00 -	AC-C ALT	MOD: 440E40T MOD: 440E40T	<b>4 PK 1070 TM</b> <b>12 PK 1815 TM</b>
<b>440.42</b>	13798 ccm	309 kW	8210.42L.400	01.93 -	AC-C ALT W-P W-P	FROM MTR-NO: 425086; REQ: 2 UNTIL MTR-NO: 425085; REQ: 2	<b>AVX 13 x 1275 TM</b> <b>AVX 13 x 1050 TM</b> <b>17 x 1150</b> <b>AVX 13 x 1200 TM</b>
<b>440.43</b>	10300 ccm	316 kW	F3AE0681D	11.99 -	AC-C ALT ALT	MOD: MP440E43TP MOD: MP440E43TP	<b>4 PK 1070 TM</b> <b>12 PK 1815 TM</b> <b>KT 7003</b>

### EuroTech MT

<b>180.24</b>	7685 ccm	176 kW	8360.46R.416 TCA	01.92 - 12.96	AC-C ALT	MTR-CODE: OM-8360.46R.416 TCA; MOD: MT 180 E 24 MTR-CODE: OM-8360.46R.416 TCA; MOD: MT 180 E 24; REQ: 2	<b>AVX 13 x 1150 TM</b> <b>AVX 13 x 1350 TM</b>
<b>180.27</b>	7685 ccm	196 kW	8360.46.417 TCA	01.92 - 12.96	AC-C ALT	MTR-CODE: OM-8360.46.417 TCA; MOD: MT 180 E 27 MTR-CODE: OM-8360.46.417 TCA; MOD: MT 180 E 27; REQ: 2	<b>AVX 13 x 1150 TM</b> <b>AVX 13 x 1350 TM</b>
<b>180.30</b>	9500 ccm	221 kW	8460.41C.320	01.92 - 12.96	AC-C AC-C ALT	MOD: MT 180 E 30 R MTR-CODE: 8460.41C.320;EURO II; MOD: MT 180 E 30 R; REQ: 2 MTR-CODE: 8460.41C.320;EURO I; MOD: MT 180 E 30 R; REQ: 2	<b>AVX 13 x 1000 TM</b> <b>AVX 13 x 1425 TM</b> <b>AVX 13 x 1400 TM</b>
<b>180.34</b>	9500 ccm	254 kW	8460.41K.406	01.92 - 12.93	AC-C AC-C ALT	MOD: MT 180 E 34 R UNTIL MTR-NO: 449935; MTR-CODE: 8460.41K.406;EURO II; MOD: MT 180 E 34 R; REQ: 2 UNTIL MTR-NO: 449935; MTR-CODE: 8460.41K.406;EURO I; MOD: MT 180 E 34 R; REQ: 2	<b>AVX 13 x 1000 TM</b> <b>AVX 13 x 1425 TM</b> <b>AVX 13 x 1400 TM</b>
<b>190.24</b>	7685 ccm	176 kW	8360.46R.416 TCA	01.97 - 08.98	AC-C ALT	MTR-CODE: OM-8360.46R.416 TCA; MOD: MT 190 E 24 MTR-CODE: OM-8360.46R.416 TCA; MOD: MT 190 E 24; REQ: 2	<b>AVX 13 x 1150 TM</b> <b>AVX 13 x 1350 TM</b>
<b>190.27</b>	7685 ccm	196 kW	8360.46.417 TCA	01.97 - 08.98	AC-C ALT	MTR-CODE: OM-8360.46.417 TCA; MOD: MT 190 E 27 MTR-CODE: OM-8360.46.417 TCA; MOD: MT 190 E 27; REQ: 2	<b>AVX 13 x 1150 TM</b> <b>AVX 13 x 1350 TM</b>
<b>190.30</b>	9500 ccm	221 kW	8460.41C.320	01.97 - 08.98	AC-C AC-C ALT	MOD: MT 190 E 30 MTR-CODE: 8460.41C.320;EURO II; MOD: MT 190 E 30; REQ: 2 MTR-CODE: 8460.41C.320;EURO I; MOD: MT 190 E 30; REQ: 2	<b>AVX 13 x 1000 TM</b> <b>AVX 13 x 1425 TM</b> <b>AVX 13 x 1400 TM</b>
<b>400.30</b>	9500 ccm	221 kW	8460.41C.320	01.92 - 08.98	AC-C AC-C ALT	MOD: MT 400 E 30 T MTR-CODE: 8460.41C.320;EURO II; MOD: MT 400 E 30 T; REQ: 2 MTR-CODE: 8460.41C.320;EURO I; MOD: MT 400 E 30 T; REQ: 2	<b>AVX 13 x 1000 TM</b> <b>AVX 13 x 1425 TM</b> <b>AVX 13 x 1400 TM</b>

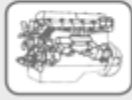

## IVECO

### EuroTech MT

#### 400.34

9500 ccm	254 kW	8460.41K.406	01.92 - 08.98	AC-C	MOD: MT 400 E 34 T	AVX 13 x 1000 TM
				AC-C	UNTIL MTR-NO: 449935; MTR-CODE: 8460.41K.406;EURO II; MOD: MT 400 E 34 T; REQ: 2	AVX 13 x 1425 TM
				ALT	UNTIL MTR-NO: 449935; MTR-CODE: 8460.41K.406;EURO I; MOD: MT 400 E 34 T; REQ: 2	AVX 13 x 1400 TM

### EuroTrakker

#### 190.30

9500 ccm	221 kW	8460.41C.	01.93 - 11.04	AC-C	MOD: MP 190 E 30 H	AVX 13 x 1000 TM
				AC-C	MTR-CODE: 8460.41C.;EURO II; MOD: MP 190 E 30 H; REQ: 2	AVX 13 x 1425 TM
				ALT	MTR-CODE: 8460.41C.;EURO I; MOD: MP 190 E 30 H; REQ: 2	AVX 13 x 1400 TM

#### 190.31

7790 ccm	228 kW	F2BE0681B	09.99 - 11.04	AC-C	UNTIL MTR-NO: F2B56021	4 PK 1025 TM
				ALT		10 PK 1725 TM

#### 190.34

9500 ccm	254 kW	8460.41K.	01.93 - 11.04	AC-C	MOD: MP 190 E 34 H	AVX 13 x 1000 TM
				ALT	UNTIL MTR-NO: 449935; MOD: MP 190 E 34 H; REQ: 2	AVX 13 x 1400 TM

#### 190.35

7790 ccm	259 kW	F2BE0681A	09.99 - 11.04	AC-C		4 PK 1025 TM
				AC-C	UNTIL MTR-NO: F2B56021; MOD: MP190E31WCursor	4 PK 1025 TM
				ALT		10 PK 1725 TM
				ALT	MOD: MP190E31WCursor	10 PK 1725 TM

#### 190.37

13798 ccm	272 kW	8210.42K.	01.93 - 11.04	AC-C	MOD: MP 190 E 37 H	AVX 13 x 1275 TM
				ALT	MOD: MP 190 E 37 H	AVX 13 x 1050 TM
				W-P	FROM MTR-NO: 425086; REQ: 2	17 x 1150
				W-P	UNTIL MTR-NO: 425085; MOD: MP 190 E 37 H; REQ: 2	AVX 13 x 1200 TM

#### 190.38

12880 ccm	280 kW	F3BE0681G	01.01 - 11.04	AC-C	OE-NO.: 500352673; MOD: MP190E38W	4 PK 1070 TM
				ALT	MOD: MP190E38W; + G-PUL; QTY: 1	12 PK 1830 TM
				ALT	MOD: MP190E38W; + G-PUL; QTY: 2	12 PK 1840 TM

#### 190.42

13798 ccm	309 kW	8210.42L(TCA);8210.42L.	01.93 - 11.04	AC-C	FROM: 01.95; MOD: MP 190 E 42 H	AVX 13 x 1275 TM
				ALT	FROM: 01.95; MOD: MP 190 E 42 H	AVX 13 x 1050 TM
				W-P	FROM MTR-NO: 425086; REQ: 2	17 x 1150
				W-P	FROM: 01.95; UNTIL MTR-NO: 425085; MOD: MP 190 E 42 H; REQ: 2	AVX 13 x 1200 TM
		8210.42L.		AC-C	FROM: 01.95; MOD: MP 190 E 42 H	AVX 13 x 1275 TM
				ALT	FROM: 01.95; MOD: MP 190 E 42 H	AVX 13 x 1050 TM
				W-P	FROM MTR-NO: 425086; REQ: 2	17 x 1150
				W-P	FROM: 01.95; UNTIL MTR-NO: 425085; MOD: MP 190 E 42 H; REQ: 2	AVX 13 x 1200 TM

#### 190.44

12880 ccm	324 kW	F3BE0681C	09.00 - 11.04	AC-C	MOD: MP190E44WCursor	4 PK 1070 TM
				ALT	MOD: MP190E44WCursor	12 PK 1840 TM

#### 260.30

9500 ccm	221 kW	8460.41C.	01.93 - 11.04	AC-C	MOD: MP 260 E 30 H	AVX 13 x 1000 TM
				AC-C	MTR-CODE: 8460.41C.;EURO II; MOD: MP 260 E 30 H; REQ: 2	AVX 13 x 1425 TM
				ALT	MTR-CODE: 8460.41C.;EURO I; MOD: MP 260 E 30 H; REQ: 2	AVX 13 x 1400 TM

#### 260.31

7790 ccm	228 kW	F2BE0681B	09.99 - 11.04	AC-C		4 PK 1025 TM
				ALT		10 PK 1725 TM

#### 260.34

9500 ccm	254 kW	8460.41K.	01.93 - 11.04	AC-C	MOD: MP 260 E 34 H	AVX 13 x 1000 TM
				ALT	UNTIL MTR-NO: 449935; MOD: MP 260 E 34 H; REQ: 2	AVX 13 x 1400 TM

#### 260.35

7790 ccm	259 kW	F2BE0681A	09.99 - 11.04	AC-C		4 PK 1025 TM
				ALT		10 PK 1725 TM

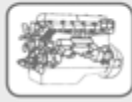

## IVECO

### EuroTrakker

<b>260.37</b>						
13798 ccm	272 kW	8210.42K.	01.93 - 11.04	AC-C ALT W-P W-P	MOD: MP 260 E 37 H MOD: MP 260 E 37 H FROM MTR-NO: 425086; REQ: 2 UNTIL MTR-NO: 425085; MOD: MP 260 E 37 H; REQ: 2	AVX 13 x 1275 TM AVX 13 x 1050 TM 17 x 1150 AVX 13 x 1200 TM
<b>260.38</b>						
12880 ccm	280 kW	F3BE0681G	01.01 - 11.04	AC-C ALT ALT	+ G-PUL; QTY: 1 + G-PUL; QTY: 2	4 PK 1070 TM 12 PK 1830 TM 12 PK 1840 TM
<b>260.42</b>						
13798 ccm	309 kW	8210.42L(TCA);8210.42L.	01.93 - 11.04	AC-C ALT W-P W-P	MOD: MP 260 E 42 H MOD: MP 260 E 42 H FROM MTR-NO: 425086; REQ: 2 UNTIL MTR-NO: 425085; MOD: MP 260 E 42 H; REQ: 2	AVX 13 x 1275 TM AVX 13 x 1050 TM 17 x 1150 AVX 13 x 1200 TM
		8210.42L.		AC-C ALT W-P W-P	MOD: MP 260 E 42 H MOD: MP 260 E 42 H FROM MTR-NO: 425086; REQ: 2 UNTIL MTR-NO: 425085; MOD: MP 260 E 42 H; REQ: 2	AVX 13 x 1275 TM AVX 13 x 1050 TM 17 x 1150 AVX 13 x 1200 TM
<b>260.44</b>						
12880 ccm	324 kW	F3BE0681C	01.00 - 11.04	AC-C ALT		4 PK 1070 TM 12 PK 1840 TM
<b>340.34</b>						
9500 ccm	254 kW	8460.41K.	01.93 - 11.04	AC-C ALT	FROM: 01.94; MOD: MP 340 E 34 H FROM: 01.94; UNTIL MTR-NO: 449935; MOD: MP 340 E 34 H; REQ: 2	AVX 13 x 1000 TM AVX 13 x 1400 TM
<b>340.35</b>						
7790 ccm	259 kW	F2BE0681A	09.99 - 11.04	AC-C ALT		4 PK 1025 TM 10 PK 1725 TM
<b>340.37</b>						
13798 ccm	272 kW	8210.42K.	01.93 - 11.04	AC-C ALT W-P W-P	FROM: 01.94; MOD: MP 340 E 37 H FROM: 01.94; MOD: MP 340 E 37 H FROM MTR-NO: 425086; REQ: 2 FROM: 01.94; UNTIL MTR-NO: 425085; MOD: MP 340 E 37 H; REQ: 2	AVX 13 x 1275 TM AVX 13 x 1050 TM 17 x 1150 AVX 13 x 1200 TM
<b>340.38</b>						
12880 ccm	280 kW	F3BE0681G	01.01 - 11.04	AC-C ALT ALT	+ G-PUL; QTY: 1 + G-PUL; QTY: 2	4 PK 1070 TM 12 PK 1830 TM 12 PK 1840 TM
<b>340.42</b>						
13798 ccm	309 kW	8210.42L.	01.93 - 11.04	AC-C ALT W-P W-P	FROM: 01.95; MOD: MP 340 E 42 H FROM: 01.95; MOD: MP 340 E 42 H FROM MTR-NO: 425086; REQ: 2 FROM: 01.95; UNTIL MTR-NO: 425085; MOD: MP 340 E 42 H; REQ: 2	AVX 13 x 1275 TM AVX 13 x 1050 TM 17 x 1150 AVX 13 x 1200 TM
<b>340.44</b>						
12880 ccm	324 kW	F3BE0681C	01.01 - 11.04	AC-C ALT	MOD: MP340E44Cursor MOD: MP340E44Cursor	4 PK 1070 TM 12 PK 1840 TM
<b>380.34</b>						
9500 ccm	254 kW	8460.41K.	01.93 - 11.04	AC-C ALT	MOD: MP 380 E 34 H UNTIL MTR-NO: 449935; MOD: MP 380 E 34 H; REQ: 2	AVX 13 x 1000 TM AVX 13 x 1400 TM
<b>380.37</b>						
13798 ccm	272 kW	8210.42K.	01.93 - 11.04	AC-C ALT W-P W-P	MOD: MP 380 E 37 H MOD: MP 380 E 37 H FROM MTR-NO: 425086; REQ: 2 UNTIL MTR-NO: 425085; MOD: MP 380 E 37 H; REQ: 2	AVX 13 x 1275 TM AVX 13 x 1050 TM 17 x 1150 AVX 13 x 1200 TM
<b>380.38</b>						
12880 ccm	280 kW	F3BE0681G	01.01 - 11.04	AC-C ALT ALT	+ G-PUL; QTY: 1 + G-PUL; QTY: 2	4 PK 1070 TM 12 PK 1830 TM 12 PK 1840 TM
<b>380.42</b>						
13798 ccm	309 kW	8210.42L.	01.93 - 11.04	AC-C ALT W-P	MOD: MP 380 E 42 H MOD: MP 380 E 42 H FROM MTR-NO: 425086; REQ: 2	AVX 13 x 1275 TM AVX 13 x 1050 TM 17 x 1150



## IVECO

### EuroTrakker

#### 380.42

13798 ccm 309 kW 8210.42L. 01.93 - 11.04 W-P UNTIL MTR-NO: 425085; MOD: MP 380 E 42 H; REQ: 2 **AVX 13 x 1200 TM**

#### 380.44

12880 ccm 324 kW F3BE0681C 01.01 - 11.04 AC-C **4 PK 1070 TM**  
ALT **12 PK 1840 TM**

#### 400.34

9500 ccm 254 kW 8460.41K.;8460.41K. TCA 01.93 - 11.04 AC-C MOD: MP 400 E 34 HT **AVX 13 x 1000 TM**  
ALT UNTIL MTR-NO: 449935; MOD: MP 400 E 34 HT; REQ: 2 **AVX 13 x 1400 TM**

#### 400.37

13798 ccm 272 kW 8210.42K(TCA);8210.42K. 01.93 - 11.04 AC-C MOD: MP 400 E 37 HT **AVX 13 x 1275 TM**  
ALT MOD: MP 400 E 37 HT **AVX 13 x 1050 TM**  
W-P FROM MTR-NO: 425086; REQ: 2 **17 x 1150**  
W-P UNTIL MTR-NO: 425085; MOD: MP 400 E 37 HT; REQ: 2 **AVX 13 x 1200 TM**

#### 400.42

13798 ccm 309 kW 8210.42L(TCA);8210.42L. 01.93 - 11.04 AC-C FROM: 01.95; MOD: MP 400 E 42 HT **AVX 13 x 1275 TM**  
ALT FROM: 01.95; MOD: MP 400 E 42 HT **AVX 13 x 1050 TM**  
W-P FROM MTR-NO: 425086; REQ: 2 **17 x 1150**  
W-P FROM: 01.95; UNTIL MTR-NO: 425085; MOD: MP 400 E 42 HT; REQ: 2 **AVX 13 x 1200 TM**

#### 410.37

13798 ccm 272 kW 8210.42K. 01.93 - 11.04 AC-C FROM: 01.94; MOD: MP 410 E 37 H **AVX 13 x 1275 TM**  
ALT FROM: 01.94; MOD: MP 410 E 37 H **AVX 13 x 1050 TM**  
W-P FROM MTR-NO: 425086; REQ: 2 **17 x 1150**  
W-P FROM: 01.94; UNTIL MTR-NO: 425085; MOD: MP 410 E 37 H; REQ: 2 **AVX 13 x 1200 TM**

#### 410.38

12880 ccm 280 kW F3BE0681G 01.01 - 11.04 AC-C **4 PK 1070 TM**  
ALT + G-PUL; QTY: 1 **12 PK 1830 TM**  
ALT + G-PUL; QTY: 2 **12 PK 1840 TM**

#### 410.42

13798 ccm 309 kW 8210.42L(TCA);8210.42L. 01.93 - 11.04 AC-C FROM: 01.94; MOD: MP 410 E 42 H **AVX 13 x 1275 TM**  
ALT FROM: 01.94; MOD: MP 410 E 42 H **AVX 13 x 1050 TM**  
W-P FROM MTR-NO: 425086; REQ: 2 **17 x 1150**  
W-P FROM: 01.94; UNTIL MTR-NO: 425085; MOD: MP 410 E 42 H; REQ: 2 **AVX 13 x 1200 TM**

8210.42L. AC-C FROM: 01.94; MOD: MP 410 E 42 H **AVX 13 x 1275 TM**  
ALT FROM: 01.94; MOD: MP 410 E 42 H **AVX 13 x 1050 TM**  
W-P FROM MTR-NO: 425086; REQ: 2 **17 x 1150**  
W-P FROM: 01.94; UNTIL MTR-NO: 425085; MOD: MP 410 E 42 H; REQ: 2 **AVX 13 x 1200 TM**

#### 440.34

9500 ccm 254 kW 8460.41K.;8460.41K. TCA 01.93 - 11.04 AC-C FROM: 01.94; MOD: MP 440 E 34 HT **AVX 13 x 1000 TM**  
ALT FROM: 01.94; UNTIL MTR-NO: 449935; MOD: MP 440 E 34 HT; REQ: 2 **AVX 13 x 1400 TM**

#### 440.37

13798 ccm 272 kW 8210.42K(TCA);8210.42K. 01.93 - 11.04 AC-C MOD: MP 440 E 37 HT **AVX 13 x 1275 TM**  
ALT MOD: MP 440 E 37 HT **AVX 13 x 1050 TM**  
W-P FROM MTR-NO: 425086; REQ: 2 **17 x 1150**  
W-P UNTIL MTR-NO: 425085; MOD: MP 440 E 37 HT; REQ: 2 **AVX 13 x 1200 TM**

#### 440.42

13798 ccm 309 kW 8210.42L(TCA);8210.42L. 01.93 - 11.04 AC-C FROM: 01.97; MOD: MP 440 E 42 HT **AVX 13 x 1275 TM**  
ALT FROM: 01.97; MOD: MP 440 E 42 HT **AVX 13 x 1050 TM**  
W-P FROM MTR-NO: 425086; REQ: 2 **17 x 1150**  
W-P FROM: 01.97; UNTIL MTR-NO: 425085; MOD: MP 440 E 42 HT; REQ: 2 **AVX 13 x 1200 TM**

#### 720.37

13798 ccm 272 kW 8210.42K(TCA);8210.42K. 01.93 - 11.04 AC-C FROM: 01.94; MOD: MP 720 E 37 HT **AVX 13 x 1275 TM**  
ALT FROM: 01.94; MOD: MP 720 E 37 HT **AVX 13 x 1050 TM**  
W-P FROM MTR-NO: 425086; REQ: 2 **17 x 1150**  
W-P FROM: 01.94; UNTIL MTR-NO: 425085; MOD: MP 720 E 37 HT; REQ: 2 **AVX 13 x 1200 TM**

#### 720.42

13798 ccm 309 kW 8210.42L(TCA);8210.42L. 01.93 - 11.04 AC-C FROM: 01.94; MOD: MP 720 E 42 HT **AVX 13 x 1275 TM**  
ALT FROM: 01.94; MOD: MP 720 E 42 HT **AVX 13 x 1050 TM**



## IVECO

### EuroTrakker

<b>720.42</b>	13798 ccm	309 kW	8210.42L(TCA);8210.42L.	01.93 - 11.04	W-P W-P	FROM MTR-NO: 425086; REQ: 2 FROM: 01.94; UNTIL MTR-NO: 425085; MOD: MP 720 E 42 HT; REQ: 2	<b>17 x 1150</b> <b>AVX 13 x 1200 TM</b>
<b>720.47</b>	13798 ccm	345 kW	8210.42M. TCA	01.93 - 11.04	AC-C ALT	FROM: 09.98; MOD: MP 720 E 47 HT FROM: 09.98; MOD: MP 720 E 47 HT	<b>AVX 13 x 1275 TM</b> <b>AVX 13 x 1050 TM</b>

### Stralis

<b>190S30; 190S31</b>	7790 ccm	218-228 kW	F2BE0681B;F2BE0681E;F2BE3681C	06.03 -		FROM: 04.06 FROM: 04.06; UNTIL: 12.12	<b>10 PK 1715 TM</b> <b>8 PK 1158 TM</b>
<b>190S31</b>	7790 ccm	228 kW	F2BE3681C	04.04 -		FROM: 04.06 FROM: 04.06; UNTIL: 12.12	<b>10 PK 1715 TM</b> <b>8 PK 1158 TM</b>
<b>190S33</b>	7790 ccm	243 kW	F2BE3681B	12.06 -		UNTIL: 12.12; MOD: <Stralis 190 S 33>	<b>10 PK 1715 TM</b> <b>8 PK 1158 TM</b> <b>10 PK 1715 TM</b>
					ALT		
<b>190S35; 190S36</b>	7790 ccm	259-265 kW	F2BE0681A;F2BE3681A	06.03 -		FROM: 04.06; MTR-CODE: F2BE3681A	<b>10 PK 1715 TM</b>
<b>190S36</b>	7790 ccm	265 kW	F2BE3681A	05.07 -			<b>10 PK 1715 TM</b>
<b>260S31</b>	7790 ccm	228 kW	F2BE3681C	06.03 -		FROM: 04.06 FROM: 04.07; UNTIL: 12.12; MOD: <Stralis N 260 S 31>	<b>10 PK 1715 TM</b> <b>8 PK 1158 TM</b>
<b>260S33</b>	7790 ccm	243 kW	F2BE3681B	12.06 -		MTR-CODE: F3AE3681B MTR-CODE: F3AE3681B*...; FROM: 04.07; UNTIL: 12.12 MTR-CODE: F3AE3681B*; FROM: 04.07; UNTIL: 12.12	<b>8 PK 1158 TM</b> <b>8 PK 1158 TM</b> <b>8 PK 1158 TM</b>
					ALT		<b>10 PK 1715 TM</b>
<b>260S36</b>	7790 ccm	265 kW	F2BE3681A	07.07 -	ALT		<b>10 PK 1715 TM</b>
<b>260S43</b>	10300 ccm	316 kW	F3AE0681D	02.02 -	ALT		<b>KT 7003</b>
<b>440S31</b>	7790 ccm	228 kW	F2BE0681B	06.03 -		FROM: 08.03; UNTIL: 03.06	<b>8 PK 1158 TM</b>
<b>440S33</b>	7790 ccm	243 kW	F2BE3681B	12.06 -	ALT		<b>10 PK 1715 TM</b>
<b>440S35; 440S36</b>	7790 ccm	259-265 kW	F2BE0681A;F2BE3681A	06.03 -		MTR-CODE: F2BE3681A; FROM: 04.06	<b>10 PK 1715 TM</b>
<b>440S40</b>	10300 ccm	294 kW	F3AE0681B	02.02 -	ALT		<b>KT 7003</b>
<b>440S43</b>	10300 ccm	316 kW	F3AE0681D	02.02 -	ALT		<b>KT 7003</b>

### Trakker

<b>190T31</b>	7790 ccm	228 kW	F2BE0681B;F2BE3681C	10.04 -		FROM: 04.06; MTR-CODE: F2BE3681C	<b>10 PK 1715 TM</b>
<b>190T33</b>	7790 ccm	243 kW	F2BE3681B	03.06 -	ALT	FROM: 04.06	<b>10 PK 1715 TM</b>
<b>190T35; 190T36</b>	7790 ccm	259 kW	F2BE0681A	10.04 -	ALT	FROM: 04.06	<b>10 PK 1715 TM</b>
		259-265 kW	F2BE0681A;F2BE3681A		ALT	FROM: 04.06; MTR-CODE: F2BE3681A	<b>10 PK 1715 TM</b>
					ALT	MTR-CODE: F2BE3681A; FROM: 04.06	<b>10 PK 1715 TM</b>
<b>260T33</b>	7790 ccm	243 kW	F2BE3681B	07.07 -	ALT		<b>10 PK 1715 TM</b>
<b>260T33; 380T33</b>	7790 ccm	243 kW	F2BE3681B	03.06 -	ALT	FROM: 04.06	<b>10 PK 1715 TM</b>
<b>260T35; 260T36; 380T36</b>	7790 ccm	259-265 kW	F2BE0681A;F2BE3681A	10.04 -		MTR-CODE: F2BE3681A; FROM: 04.06	<b>10 PK 1715 TM</b>
<b>260T36</b>	7790 ccm	265 kW	F2BE3681A	03.06 -			<b>10 PK 1715 TM</b>



## IVECO

### Trakker

<b>260T36</b>	7790 ccm	265 kW	F2BE3681A	03.06 -	FROM: 04.06	10 PK 1715 TM
<b>260T36; 380T36</b>	7790 ccm	265 kW	F2BE3681A	10.04 -	FROM: 04.06	10 PK 1715 TM
<b>340T36</b>	7790 ccm	265 kW	F2BE3681A	03.06 -	FROM: 04.06	10 PK 1715 TM 10 PK 1715 TM
<b>380T36</b>	7790 ccm	265 kW	F2BE3681A	04.06 -		10 PK 1715 TM
<b>400T36</b>	7790 ccm	265 kW	F2BE3681A	10.04 -	FROM: 04.06	10 PK 1715 TM
<b>410T36</b>	7790 ccm	265 kW	F2BE3681A	03.06 -	FROM: 04.06	10 PK 1715 TM

## MAN

### EL

<b>202; 222</b>	6871 ccm	157-169 kW	D 0826 LUH 03;D 0826 LUH 05;D 0826 LUH 12	01.93 - 06.97	AC-C	MTR-CODE: D0826LUH; MOD: EL202,EL222	6 PK 1515 TM
					ALT	MTR-CODE: D0826LUH; OE-NO.: 51968200231; AMP: 120; MOD: EL202,EL222	12 PK 1865 TM
<b>202; 262</b>	6871 ccm	184 kW	D 0826 LUH	04.94 - 06.97	AC-C	MOD: EL202,EL222	6 PK 1515 TM
					ALT	OE-NO.: 51968200231; AMP: 120; MOD: EL202,EL222	12 PK 1865 TM
<b>262</b>	11967 ccm	191 kW	D 2866 LUH 22	07.98 -	AC-C	MTR-CODE: D 2866 LUH 22; OE-NO.: 06580732272; AMP: 120; MOD: EL 262; REQ: 2	AVX 13 x 1150 TM
					AC-C	MTR-CODE: D 2866 LUH 22; OE-NO.: 06580732272; AMP: 140; MOD: EL 262; REQ: 2	AVX 13 x 1150 TM
					ALT	OE-NO.: 06580732292; AMP: 140; MOD: EL 262; REQ: 2	AVX 13 x 1200 TM
					FAN	MOD: EL 262; REQ: 2	AVX 13 x 1300 TM
					FAN	MTR-CODE: D 2866 LUH 22; OE-NO.: 06580732262; AMP: 120; MOD: EL 262; REQ: 2	AVX 13 x 1125 TM
					FAN	OE-NO.: 06580732282; AMP: 140; MOD: EL 262; REQ: 2	AVX 13 x 1175 TM
					S-PUL	MTR-CODE: D 2866 LUH 22; OE-NO.: 06580732262; AMP: 140; MOD: EL 262; REQ: 2	AVX 13 x 1125 TM
					W-P	MOD: EL 262; REQ: 2	AVX 13 x 1225 TM

### F 2000

<b>19.233</b>	11967 ccm	170 kW	E 2866 DF 01	01.94 -	AC-C	MTR-CODE: E 2866 DF01; MOD: 19.233 FCNG; REQ: 2	AVX 13 x 1450 TM
					FAN	MTR-CODE: E 2866 DF01; MOD: 19.233 FCNG; REQ: 2	AVX 13 x 1225 TM
					HYD-P	MTR-CODE: E 2866 DF01; MOD: 19.233 FCNG; REQ: 2	AVX 13 x 1525 TM
					ALT		KT 7006
					ALT; AC-C		KT 7005
<b>19.273</b>	9973 ccm	198 kW	D 2865 LF22	01.94 -	AC-C		AVX 13 x 1450 TM
					FAN	REQ: 2	AVX 13 x 1225 TM
					HYD-P	REQ: 2	AVX 13 x 1525 TM
<b>19.293</b>	9973 ccm	213 kW	D 2865 LF20;D 2865 LF24	01.94 -	AC-C	MTR-CODE: D 2865 LF20;D 2865 LF24; MOD: 19.293 FAC	AVX 13 x 1450 TM
					FAN	MTR-CODE: D 2865 LF20;D 2865 LF24; MOD: 19.293 FAC; REQ: 2	AVX 13 x 1225 TM
					HYD-P	MTR-CODE: D 2865 LF20;D 2865 LF24; MOD: 19.293 FAC; REQ: 2	AVX 13 x 1525 TM
<b>19.323</b>	9973 ccm	235 kW	D 2865 LF23	01.94 - 12.95	AC-C	MOD: 19.323 FAC; REQ: 2	AVX 13 x 1450 TM
					FAN	MOD: 19.323 FAC; REQ: 2	AVX 13 x 1225 TM
					HYD-P	MOD: 19.323 FAC; REQ: 2	AVX 13 x 1525 TM
<b>19.343</b>	9973 ccm	250 kW	D 2865 LF21	01.94 -	AC-C	MOD: 19.343 FAC	AVX 13 x 1450 TM
					FAN	MOD: 19.343 FAC; REQ: 2	AVX 13 x 1225 TM



# MAN

## F 2000

<b>19.343</b>						
9973 ccm	250 kW	D 2866 LF21	01.94 -	HYD-P	MOD: 19.343 FAC; REQ: 2	AVX 13 x 1525 TM
<b>19.364</b>						
11967 ccm	265 kW	D 2866 LF35	06.98 -	AC-C	MOD: 19.364 FAC	AVX 13 x 1450 TM
				FAN	MOD: 19.364 FAC; REQ: 2	AVX 13 x 1225 TM
				HYD-P	MOD: 19.364 FAC; REQ: 2	AVX 13 x 1525 TM
<b>19.373</b>						
11967 ccm	272 kW	D 2866 LF21	01.94 -	AC-C	MOD: 19.373 FAC	AVX 13 x 1450 TM
				FAN	MOD: 19.373 FAC; REQ: 2	AVX 13 x 1225 TM
				HYD-P	MOD: 19.373 FAC; REQ: 2	AVX 13 x 1525 TM
				ALT		KT 7006
				ALT; AC-C		KT 7005
<b>19.403</b>						
11967 ccm	294 kW	D 2866 LF20	01.94 -	AC-C	MOD: 19.403 FAC	AVX 13 x 1450 TM
				FAN	MOD: 19.403 FAC; REQ: 2	AVX 13 x 1225 TM
				HYD-P	MOD: 19.403 FAC; REQ: 2	AVX 13 x 1525 TM
				ALT		KT 7006
				ALT; AC-C		KT 7005
<b>19.414</b>						
11967 ccm	301 kW	D 2866 LF31	06.98 -	AC-C	MOD: 19.414 FAC	AVX 13 x 1450 TM
				FAN	MOD: 19.414 FAC; REQ: 2	AVX 13 x 1225 TM
				HYD-P	MOD: 19.414 FAC; REQ: 2	AVX 13 x 1525 TM
<b>19.423</b>						
11967 ccm	309 kW	D 2866 LF22	01.94 -	AC-C	MOD: 19.423 FAC	AVX 13 x 1450 TM
				FAN	MOD: 19.423 FAC; REQ: 2	AVX 13 x 1225 TM
				HYD-P	MOD: 19.423 FAC; REQ: 2	AVX 13 x 1525 TM
				ALT		KT 7006
				ALT; AC-C		KT 7005
<b>19.463</b>						
12816 ccm	338 kW	D 2876 LF 02	01.94 -	AC-C	FROM: 06.96; UNTIL: 09.01; MTR-CODE: D 2876 LF 02; MOD: 19.463; REQ: 2	AVX 13 x 1450 TM
				AC-C	MTR-CODE: D 2876 LF 02; MOD: 19.463 FAC; REQ: 2	AVX 13 x 1450 TM
				FAN	FROM: 06.96; UNTIL: 09.01; MTR-CODE: D 2876 LF 02; MOD: 19.463; REQ: 2	AVX 13 x 1225 TM
				FAN	MTR-CODE: D 2876 LF 02; MOD: 19.463 FAC; REQ: 2	AVX 13 x 1225 TM
				ALT		KT 7006
				ALT; AC-C		KT 7005
<b>19.464</b>						
12816 ccm	338 kW	D 2876 LF 06	06.98 -	AC-C	MTR-CODE: D 2876 LF 06; MOD: 19.464 FAK; REQ: 2	AVX 13 x 1450 TM
				AC-C	UNTIL: 09.01; MTR-CODE: D 2876 LF 06; MOD: 19.464; REQ: 2	AVX 13 x 1450 TM
				AC-C	UNTIL: 09.01; MTR-CODE: D 2876 LF 06; MOD: 26.464; REQ: 2	AVX 13 x 1450 TM
				AC-C	UNTIL: 09.01; MTR-CODE: D 2876 LF 06; MOD: 28.464; REQ: 2	AVX 13 x 1450 TM
				AC-C	UNTIL: 09.01; MTR-CODE: D 2876 LF 06; MOD: 30.464; REQ: 2	AVX 13 x 1450 TM
				AC-C	UNTIL: 09.01; MTR-CODE: D 2876 LF 06; MOD: 32.464; REQ: 2	AVX 13 x 1450 TM
				AC-C	UNTIL: 09.01; MTR-CODE: D 2876 LF 06; MOD: 33.464; REQ: 2	AVX 13 x 1450 TM
				AC-C	UNTIL: 09.01; MTR-CODE: D 2876 LF 06; MOD: 35.464; REQ: 2	AVX 13 x 1450 TM
				AC-C	UNTIL: 09.01; MTR-CODE: D 2876 LF 06; MOD: 40.464; REQ: 2	AVX 13 x 1450 TM
				AC-C	UNTIL: 09.01; MTR-CODE: D 2876 LF 06; MOD: 41.464; REQ: 2	AVX 13 x 1450 TM
				AC-C	UNTIL: 09.01; MTR-CODE: D 2876 LF 06; MOD: 50.464; REQ: 2	AVX 13 x 1450 TM
				FAN	MTR-CODE: D 2876 LF 06; MOD: 19.464 FAK; REQ: 2	AVX 13 x 1225 TM
				FAN	UNTIL: 09.01; MTR-CODE: D 2876 LF 06; MOD: 19.464; REQ: 2	AVX 13 x 1225 TM
				FAN	UNTIL: 09.01; MTR-CODE: D 2876 LF 06; MOD: 26.464; REQ: 2	AVX 13 x 1225 TM
				FAN	UNTIL: 09.01; MTR-CODE: D 2876 LF 06; MOD: 28.464; REQ: 2	AVX 13 x 1225 TM



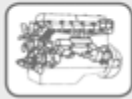

## MAN

### F 2000

#### 19.464

12816 ccm	338 kW	D 2876 LF 06	06.98 -	FAN	UNTIL: 09.01; MTR-CODE: D 2876 LF 06; MOD: 30.464; REQ: 2	AVX 13 x 1225 TM
				FAN	UNTIL: 09.01; MTR-CODE: D 2876 LF 06; MOD: 32.464; REQ: 2	AVX 13 x 1225 TM
				FAN	UNTIL: 09.01; MTR-CODE: D 2876 LF 06; MOD: 33.464; REQ: 2	AVX 13 x 1225 TM
				FAN	UNTIL: 09.01; MTR-CODE: D 2876 LF 06; MOD: 35.464; REQ: 2	AVX 13 x 1225 TM
				FAN	UNTIL: 09.01; MTR-CODE: D 2876 LF 06; MOD: 40.464; REQ: 2	AVX 13 x 1225 TM
				FAN	UNTIL: 09.01; MTR-CODE: D 2876 LF 06; MOD: 41.464; REQ: 2	AVX 13 x 1225 TM
				FAN	UNTIL: 09.01; MTR-CODE: D 2876 LF 06; MOD: 50.464; REQ: 2	AVX 13 x 1225 TM

#### 19.603; 19604

18273 ccm	441 kW	D 2840 LF20	04.96 -	AC-C	MOD: 19.603FLS	4 PK 1290 TM
				ALT	MOD: 19.603FLS	12 PK 1965 TM

#### 23.403

11967 ccm	294 kW	D 2866 LF20	01.94 -	AC-C	MOD: 23.403 FNLLC	AVX 13 x 1450 TM
				FAN	MOD: 23.403 FNLLC; REQ: 2	AVX 13 x 1225 TM
				HYD-P	MOD: 23.403 FNLLC; REQ: 2	AVX 13 x 1525 TM
				ALT		KT 7006
				ALT; AC-C		KT 7005

#### 23.463

12816 ccm	338 kW	D 2876 LF 02	01.94 -	AC-C	MOD: 23.463 FNLLC; REQ: 2	AVX 13 x 1450 TM
				FAN	MOD: 23.463 FNLLC; REQ: 2	AVX 13 x 1225 TM
				ALT		KT 7006
				ALT; AC-C		KT 7005

#### 24.273

9973 ccm	198 kW	D 2865 LF22	01.94 - 12.95	AC-C	MOD: 24.273 FNLLC	AVX 13 x 1450 TM
				FAN	MOD: 24.273 FNLLC; REQ: 2	AVX 13 x 1225 TM
				HYD-P	MOD: 24.273 FNLLC; REQ: 2	AVX 13 x 1525 TM

#### 24.323

9973 ccm	235 kW	D 2865 LF23	01.94 - 12.95	AC-C	MOD: 24.323 FNLLC; REQ: 2	AVX 13 x 1450 TM
				FAN	MOD: 24.323 FNLLC; REQ: 2	AVX 13 x 1225 TM
				HYD-P	MOD: 24.323 FNLLC; REQ: 2	AVX 13 x 1525 TM

#### 24.373

11967 ccm	272 kW	D 2866 LF21	01.94 - 12.95	AC-C	MOD: 24.373 FNLLC	AVX 13 x 1450 TM
				FAN	MOD: 24.373 FNLLC; REQ: 2	AVX 13 x 1225 TM
				HYD-P	MOD: 24.373 FNLLC; REQ: 2	AVX 13 x 1525 TM
				ALT		KT 7006
				ALT; AC-C		KT 7005

#### 24.403

11967 ccm	294 kW	D 2866 LF20	01.94 -	ALT		KT 7006
				ALT; AC-C		KT 7005

#### 24.423

11967 ccm	309 kW	D 2866 LF22	01.94 - 12.95	ALT		KT 7006
				ALT; AC-C		KT 7005

#### 24.463

12816 ccm	338 kW	D 2876 LF 02	01.94 -	ALT		KT 7006
				ALT; AC-C		KT 7005

#### 26.233

11967 ccm	170 kW	E 2866 DF 01	09.96 -	AC-C	MTR-CODE: E 2866 DF01; MOD: 26.233 FVLCNG; REQ: 2	AVX 13 x 1450 TM
				FAN	MTR-CODE: E 2866 DF01; MOD: 26.233 FVLCNG; REQ: 2	AVX 13 x 1225 TM
				HYD-P	MTR-CODE: E 2866 DF01; MOD: 26.233 FVLCNG; REQ: 2	AVX 13 x 1525 TM
				ALT		KT 7006
				ALT; AC-C		KT 7005

#### 26.273

9973 ccm	198 kW	D 2865 LF22	01.94 - 12.95	AC-C		AVX 13 x 1450 TM
				FAN	REQ: 2	AVX 13 x 1225 TM
				HYD-P	REQ: 2	AVX 13 x 1525 TM

#### 26.293

9973 ccm	213 kW	D 2865 LF20; D 2865 LF24	01.94 -	AC-C	MTR-CODE: D 2865 LF20; D 2865 LF24	AVX 13 x 1450 TM
				FAN	MTR-CODE: D 2865 LF20; D 2865 LF24; REQ: 2	AVX 13 x 1225 TM

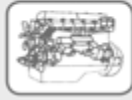
**MAN**
**F 2000**

<b>26.293</b>	9973 ccm	213 kW	D 2865 LF20;D 2865 LF24	01.94 -	HYD-P	MTR-CODE: D 2865 LF20;D 2865 LF24; REQ: 2	<b>AVX 13 x 1525 TM</b>
<b>26.323</b>	9973 ccm	235 kW	D 2865 LF23	01.94 - 12.95	AC-C FAN HYD-P	REQ: 2 REQ: 2 REQ: 2	<b>AVX 13 x 1450 TM</b> <b>AVX 13 x 1225 TM</b> <b>AVX 13 x 1525 TM</b>
<b>26.343</b>	9973 ccm	250 kW	D 2865 LF21	01.94 -	AC-C FAN HYD-P	REQ: 2 REQ: 2	<b>AVX 13 x 1450 TM</b> <b>AVX 13 x 1225 TM</b> <b>AVX 13 x 1525 TM</b>
<b>26.373</b>	11967 ccm	272 kW	D 2866 LF21	01.94 - 12.95	AC-C FAN HYD-P ALT ALT; AC-C	REQ: 2 REQ: 2	<b>AVX 13 x 1450 TM</b> <b>AVX 13 x 1225 TM</b> <b>AVX 13 x 1525 TM</b> <b>KT 7006</b> <b>KT 7005</b>
<b>26.403</b>	11967 ccm	294 kW	D 2866 LF20	01.94 -	AC-C FAN HYD-P ALT ALT; AC-C	REQ: 2 REQ: 2	<b>AVX 13 x 1450 TM</b> <b>AVX 13 x 1225 TM</b> <b>AVX 13 x 1525 TM</b> <b>KT 7006</b> <b>KT 7005</b>
<b>26.423</b>	11967 ccm	309 kW	D 2866 LF22	01.94 - 12.95	AC-C FAN HYD-P ALT ALT; AC-C	REQ: 2 REQ: 2	<b>AVX 13 x 1450 TM</b> <b>AVX 13 x 1225 TM</b> <b>AVX 13 x 1525 TM</b> <b>KT 7006</b> <b>KT 7005</b>
<b>26.463</b>	12816 ccm	338 kW	D 2876 LF 02	01.94 -	AC-C AC-C AC-C AC-C AC-C AC-C AC-C AC-C AC-C FAN FAN FAN FAN FAN FAN FAN FAN FAN FAN ALT ALT; AC-C	FROM: 03.97; UNTIL: 09.01; MTR-CODE: D 2876 LF 02; MOD: 30.463; REQ: 2 FROM: 03.97; UNTIL: 09.01; MTR-CODE: D 2876 LF 02; MOD: 41.463; REQ: 2 FROM: 09.96; UNTIL: 09.01; MTR-CODE: D 2876 LF 02; MOD: 26.463; REQ: 2 FROM: 09.96; UNTIL: 09.01; MTR-CODE: D 2876 LF 02; MOD: 28.463; REQ: 2 FROM: 09.96; UNTIL: 09.01; MTR-CODE: D 2876 LF 02; MOD: 33.463; REQ: 2 FROM: 09.96; UNTIL: 09.01; MTR-CODE: D 2876 LF 02; MOD: 35.463; REQ: 2 MTR-CODE: D 2876 LF 02; REQ: 2 FROM: 03.97; UNTIL: 09.01; MTR-CODE: D 2876 LF 02; MOD: 30.463; REQ: 2 FROM: 03.97; UNTIL: 09.01; MTR-CODE: D 2876 LF 02; MOD: 41.463; REQ: 2 FROM: 09.96; UNTIL: 09.01; MTR-CODE: D 2876 LF 02; MOD: 26.463; REQ: 2 FROM: 09.96; UNTIL: 09.01; MTR-CODE: D 2876 LF 02; MOD: 28.463; REQ: 2 FROM: 09.96; UNTIL: 09.01; MTR-CODE: D 2876 LF 02; MOD: 33.463; REQ: 2 FROM: 09.96; UNTIL: 09.01; MTR-CODE: D 2876 LF 02; MOD: 35.463; REQ: 2 MTR-CODE: D 2876 LF 02; REQ: 2	<b>AVX 13 x 1450 TM</b> <b>AVX 13 x 1450 TM</b> <b>AVX 13 x 1450 TM</b> <b>AVX 13 x 1450 TM</b> <b>AVX 13 x 1450 TM</b> <b>AVX 13 x 1450 TM</b> <b>AVX 13 x 1450 TM</b> <b>AVX 13 x 1225 TM</b> <b>AVX 13 x 1225 TM</b> <b>AVX 13 x 1225 TM</b> <b>AVX 13 x 1225 TM</b> <b>AVX 13 x 1225 TM</b> <b>AVX 13 x 1225 TM</b> <b>AVX 13 x 1225 TM</b> <b>AVX 13 x 1225 TM</b> <b>AVX 13 x 1225 TM</b> <b>AVX 13 x 1225 TM</b> <b>AVX 13 x 1225 TM</b> <b>AVX 13 x 1225 TM</b> <b>KT 7006</b> <b>KT 7005</b>
<b>26.603</b>	18273 ccm	441 kW	D 2840 LF20	06.96 -	AC-C ALT		<b>4 PK 1290 TM</b> <b>12 PK 1965 TM</b>
<b>27.273</b>	9973 ccm	198 kW	D 2865 LF22	01.94 - 12.95	AC-C FAN HYD-P	MOD: 27.273 DFAC MOD: 27.273 DFAC; REQ: 2 MOD: 27.273 DFAC; REQ: 2	<b>AVX 13 x 1450 TM</b> <b>AVX 13 x 1225 TM</b> <b>AVX 13 x 1525 TM</b>
<b>27.293</b>	9973 ccm	213 kW	D 2865 LF20;D 2865 LF24	01.94 -	AC-C FAN	MTR-CODE: D 2865 LF20;D 2865 LF24; MOD: 27.293 DFAC MTR-CODE: D 2865 LF20;D 2865 LF24; MOD: 27.293 DFAC; REQ: 2	<b>AVX 13 x 1450 TM</b> <b>AVX 13 x 1225 TM</b>

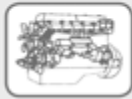

## MAN

### F 2000

#### 27.293

9973 ccm 213 kW D 2865 LF20;D 2865 LF24 01.94 - HYD-P MTR-CODE: D 2865 LF20;D 2865 LF24; MOD: 27.293 DFAC; REQ: 2 AVX 13 x 1525 TM

#### 27.323

9973 ccm 235 kW D 2865 LF23 01.94 - AC-C MOD: 27.323 DFAC; REQ: 2 AVX 13 x 1450 TM  
FAN MOD: 27.323 DFAC; REQ: 2 AVX 13 x 1225 TM  
HYD-P MOD: 27.323 DFAC; REQ: 2 AVX 13 x 1525 TM

#### 27.343

9973 ccm 250 kW D 2865 LF21 01.94 - AC-C MOD: 27.343 DFAC AVX 13 x 1450 TM  
FAN MOD: 27.343 DFAC; REQ: 2 AVX 13 x 1225 TM  
HYD-P MOD: 27.343 DFAC; REQ: 2 AVX 13 x 1525 TM

#### 27.373

11967 ccm 272 kW D 2866 LF21 01.94 - AC-C MOD: 27.373 DFAC AVX 13 x 1450 TM  
FAN MOD: 27.373 DFAC; REQ: 2 AVX 13 x 1225 TM  
HYD-P MOD: 27.373 DFAC; REQ: 2 AVX 13 x 1525 TM  
ALT KT 7006  
ALT; AC-C KT 7005

#### 27.403

11967 ccm 294 kW D 2866 LF20 01.94 - AC-C MOD: 27.403 DFAC AVX 13 x 1450 TM  
FAN MOD: 27.403 DFAC; REQ: 2 AVX 13 x 1225 TM  
HYD-P MOD: 27.403 DFAC; REQ: 2 AVX 13 x 1525 TM  
ALT KT 7006  
ALT; AC-C KT 7005

#### 27.423

11967 ccm 309 kW D 2866 LF22 01.94 - AC-C MOD: 27.423 DFAC AVX 13 x 1450 TM  
FAN MOD: 27.423 DFAC; REQ: 2 AVX 13 x 1225 TM  
HYD-P MOD: 27.423 DFAC; REQ: 2 AVX 13 x 1525 TM  
ALT KT 7006  
ALT; AC-C KT 7005

#### 27.463

12816 ccm 338 kW D 2876 LF 02 01.94 - AC-C MOD: 27.463 DFAC; REQ: 2 AVX 13 x 1450 TM  
ALT AVX 10 x 1500 TM  
FAN MOD: 27.463 DFAC; REQ: 2 AVX 13 x 1225 TM  
ALT KT 7006  
ALT; AC-C KT 7005

#### 27.603

18273 ccm 441 kW D 2840 LF20 01.96 - AC-C MOD: 27.603DFAS 4 PK 1290 TM  
ALT MOD: 27.603DFAS 12 PK 1965 TM

#### 32.343

9973 ccm 250 kW D 2865 LF21 08.95 - AC-C MOD: 32.343 VFC AVX 13 x 1450 TM  
FAN MOD: 32.343 VFC; REQ: 2 AVX 13 x 1225 TM  
HYD-P MOD: 32.343 VFC; REQ: 2 AVX 13 x 1525 TM

#### 32.403

11967 ccm 294 kW D 2866 LF20 08.95 - AC-C MOD: 32.403 VFC AVX 13 x 1450 TM  
FAN MOD: 32.403 VFC; REQ: 2 AVX 13 x 1225 TM  
HYD-P MOD: 32.403 VFC; REQ: 2 AVX 13 x 1525 TM  
ALT KT 7006  
ALT; AC-C KT 7005

#### 32.463

12816 ccm 338 kW D 2876 LF 02 08.95 - AC-C MOD: 32.463 VFC; REQ: 2 AVX 13 x 1450 TM  
FAN MOD: 32.463 VFC; REQ: 2 AVX 13 x 1225 TM  
ALT KT 7006  
ALT; AC-C KT 7005

#### 33.323

9973 ccm 235 kW D 2865 LF23 01.94 - 12.95 AC-C MOD: 33.323 DFAC; REQ: 2 AVX 13 x 1450 TM  
FAN MOD: 33.323 DFAC; REQ: 2 AVX 13 x 1225 TM  
HYD-P MOD: 33.323 DFAC; REQ: 2 AVX 13 x 1525 TM

#### 33.343

9973 ccm 250 kW D 2865 LF21 01.94 - AC-C MOD: 33.343 DFAC AVX 13 x 1450 TM  
FAN MOD: 33.343 DFAC; REQ: 2 AVX 13 x 1225 TM  
HYD-P MOD: 33.343 DFAC; REQ: 2 AVX 13 x 1525 TM

#### 33.373

11967 ccm 272 kW D 2866 LF21 01.94 - AC-C MOD: 33.373 DFAC AVX 13 x 1450 TM  
FAN MOD: 33.373 DFAC; REQ: 2 AVX 13 x 1225 TM  
HYD-P MOD: 33.373 DFAC; REQ: 2 AVX 13 x 1525 TM  
ALT KT 7006

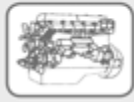
**MAN**
**F 2000**

<b>33.373</b>						
11967 ccm	272 kW	D 2866 LF21	01.94 -	ALT; AC-C		KT 7005
<b>33.403</b>						
11967 ccm	294 kW	D 2866 LF20	01.94 -	AC-C FAN HYD-P ALT ALT; AC-C	MOD: 33.403 DFAC MOD: 33.403 DFAC; REQ: 2 MOD: 33.403 DFAC; REQ: 2	AVX 13 x 1450 TM AVX 13 x 1225 TM AVX 13 x 1525 TM KT 7006 KT 7005
<b>33.423</b>						
11967 ccm	309 kW	D 2866 LF22	01.94 -	AC-C FAN HYD-P ALT ALT; AC-C	MOD: 33.423 DFAC MOD: 33.423 DFAC; REQ: 2 MOD: 33.423 DFAC; REQ: 2	AVX 13 x 1450 TM AVX 13 x 1225 TM AVX 13 x 1525 TM KT 7006 KT 7005
<b>33.463</b>						
12816 ccm	338 kW	D 2876 LF 02	01.94 -	AC-C FAN ALT ALT; AC-C	MOD: 33.463 DFAC; REQ: 2 MOD: 33.463 DFAC; REQ: 2	AVX 13 x 1450 TM AVX 13 x 1225 TM KT 7006 KT 7005
<b>33.603</b>						
18273 ccm	441 kW	D 2840 LF20	06.96 -	AC-C ALT	MOD: 33.603DFAC MOD: 33.603DFAC	4 PK 1290 TM 12 PK 1965 TM
<b>35.343</b>						
9973 ccm	250 kW	D 2865 LF21	08.95 -	AC-C FAN HYD-P	MOD: 35.343 VFC MOD: 35.343 VFC; REQ: 2 MOD: 35.343 VFC; REQ: 2	AVX 13 x 1450 TM AVX 13 x 1225 TM AVX 13 x 1525 TM
<b>35.403</b>						
11967 ccm	294 kW	D 2866 LF20	08.95 -	AC-C FAN HYD-P ALT ALT; AC-C	MOD: 35.403 VFC MOD: 35.403 VFC; REQ: 2 MOD: 35.403 VFC; REQ: 2	AVX 13 x 1450 TM AVX 13 x 1225 TM AVX 13 x 1525 TM KT 7006 KT 7005
<b>35.463</b>						
12816 ccm	338 kW	D 2876 LF 02	08.95 -	AC-C FAN ALT ALT; AC-C	MOD: 35.463 VFC; REQ: 2 MOD: 35.463 VFC; REQ: 2	AVX 13 x 1450 TM AVX 13 x 1225 TM KT 7006 KT 7005
<b>41.403</b>						
11967 ccm	294 kW	D 2866 LF20	08.95 -	AC-C FAN HYD-P ALT ALT; AC-C	MOD: 41.403 VFC MOD: 41.403 VFC; REQ: 2 MOD: 41.403 VFC; REQ: 2	AVX 13 x 1450 TM AVX 13 x 1225 TM AVX 13 x 1525 TM KT 7006 KT 7005
<b>41.463</b>						
12816 ccm	338 kW	D 2876 LF 02	08.95 -	AC-C FAN ALT ALT; AC-C	MOD: 41.463 VFC; REQ: 2 MOD: 41.463 VFC; REQ: 2	AVX 13 x 1450 TM AVX 13 x 1225 TM KT 7006 KT 7005

**F 90**

<b>19.242</b>						
11967 ccm	177 kW	D 2866 F/240	01.88 - 02.89	AC-C W-P	MTR-CODE: D 2866 F;240; REQ: 2 MTR-CODE: D 2866 F;240; REQ: 2	AVX 13 x 1450 TM AVX 13 x 1225 TM
<b>19.262</b>						
9973 ccm	191 kW	D 2865 LF/260	01.88 - 02.90	AC-C W-P	MTR-CODE: D 2865 LF;260; REQ: 2 MTR-CODE: D 2865 LF;260; REQ: 2	AVX 13 x 1450 TM AVX 13 x 1225 TM
<b>19.272</b>						
9973 ccm	198 kW	D 2865 LF02;D 2865 LF05	02.90 - 05.95	AC-C ALT HYD-P W-P	MTR-CODE: D 2865 LF02 UNTIL: 06.93; MTR-CODE: D 2865 LF02 MTR-CODE: D 2865 LF02; REQ: 2 MTR-CODE: D 2865 LF02; REQ: 2	AVX 13 x 1450 TM AVX 13 x 1475 TM AVX 13 x 1425 TM AVX 13 x 1225 TM
<b>19.292</b>						
11967 ccm	213 kW	D 2866 LF/290	07.86 - 02.90	AC-C W-P	MTR-CODE: D 2866 LF;290; REQ: 2 MTR-CODE: D 2866 LF;290; REQ: 2	AVX 13 x 1450 TM AVX 13 x 1225 TM
<b>19.322</b>						
9973 ccm	235 kW	D 2865 LF03;D 2865 LF06	02.90 - 06.96	AC-C	MTR-CODE: D 2865 LF03	AVX 13 x 1450 TM

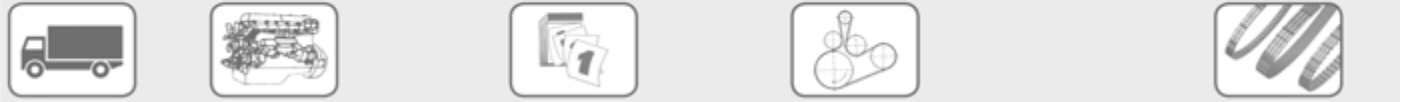

# MAN

## F 90

<b>19.322</b>						
9973 ccm	235 kW	D 2865 LF03;D 2865 LF06	02.90 - 06.96	ALT HYD-P W-P	UNTIL: 06.93; MTR-CODE: D 2865 LF03; REQ: 2 MTR-CODE: D 2865 LF03; REQ: 2 MTR-CODE: D 2865 LF03; REQ: 2	AVX 13 x 1475 TM AVX 13 x 1425 TM AVX 13 x 1225 TM

<b>19.332</b>						
11967 ccm	243 kW	D 2866 LF/330	07.86 - 02.90	AC-C ALT W-P	MTR-CODE: D 2866 LF;330; REQ: 2 MTR-CODE: D 2866 LF;330; REQ: 2 MTR-CODE: D 2866 LF;330; REQ: 2	AVX 13 x 1450 TM AVX 13 x 1475 TM AVX 13 x 1225 TM

<b>19.342</b>						
9973 ccm	250 kW	D 2865 LF09	05.94 - 06.96	AC-C AC-C AC-C HYD-P W-P	MTR-CODE: D 2865 LF09; OE-NO.: 06580722392 OE-NO.: 06580722402 MTR-CODE: D 2865 LF09; REQ: 2 REQ: 2	AVX 13 x 1425 TM AVX 13 x 1450 TM AVX 13 x 1475 TM AVX 13 x 1450 TM AVX 13 x 1225 TM

<b>19.362</b>						
11967 ccm	265 kW	D 2866 KF;D 2866 LXF	07.86 - 02.90	ALT ALT ALT ALT HYD-P HYD-P HYD-P HYD-P W-P W-P W-P W-P W-P W-P W-P W-P W-P W-P W-P W-P W-P W-P W-P W-P	MTR-CODE: D 2866 KF MTR-CODE: D 2866 LF; MOD: 17.362 MTR-CODE: D 2866 LF; MOD: 25.362 MTR-CODE: D 2866 LF; MOD: 30.362 MTR-CODE: D 2866 KF; REQ: 2 MTR-CODE: D 2866 LF; MOD: 17.362; REQ: 2 MTR-CODE: D 2866 LF; MOD: 25.362; REQ: 2 MTR-CODE: D 2866 LF; MOD: 30.362; REQ: 2 MTR-CODE: D 2866 KF; REQ: 2 MTR-CODE: D 2866 LF; MOD: 17.362; REQ: 2 MTR-CODE: D 2866 LF; MOD: 25.362; REQ: 2 MTR-CODE: D 2866 LF; MOD: 30.362; REQ: 2 MTR-CODE: D 2866 KF; REQ: 2 MTR-CODE: D 2866 LF; MOD: 17.362; REQ: 2 MTR-CODE: D 2866 LF; MOD: 25.362; REQ: 2 MTR-CODE: D 2866 LF; MOD: 30.362; REQ: 2 MTR-CODE: D 2866 KF; REQ: 2 MTR-CODE: D 2866 LF; MOD: 17.362; REQ: 2 MTR-CODE: D 2866 LF; MOD: 25.362; REQ: 2 MTR-CODE: D 2866 LF; MOD: 30.362; REQ: 2 MTR-CODE: D 2866 KF; REQ: 2 MTR-CODE: D 2866 LF; MOD: 17.362; REQ: 2 MTR-CODE: D 2866 LF; MOD: 25.362; REQ: 2 MTR-CODE: D 2866 LF; MOD: 30.362; REQ: 2	AVX 13 x 1475 TM AVX 13 x 1475 TM AVX 13 x 1475 TM AVX 13 x 1475 TM AVX 13 x 1450 TM AVX 13 x 1450 TM AVX 13 x 1450 TM AVX 13 x 1450 TM AVX 13 x 1225 TM AVX 13 x 1225 TM AVX 13 x 1225 TM AVX 13 x 1225 TM AVX 13 x 1225 TM AVX 13 x 1475 TM AVX 13 x 1475 TM AVX 13 x 1475 TM AVX 13 x 1475 TM AVX 13 x 1450 TM AVX 13 x 1450 TM AVX 13 x 1450 TM AVX 13 x 1450 TM AVX 13 x 1225 TM

<b>19.372</b>						
11967 ccm	272 kW	D 2866 LF03;D 2866 LF05;D 2866 LF15	02.90 - 06.96	AC-C HYD-P W-P	MTR-CODE: D 2866 LF03 MTR-CODE: D 2866 LF03; REQ: 2 MTR-CODE: D 2866 LF03; REQ: 2	AVX 13 x 1450 TM AVX 13 x 1450 TM AVX 13 x 1225 TM

<b>19.402</b>						
11967 ccm	294 kW	D 2866 LF16	05.94 - 06.96	AC-C HYD-P W-P	MTR-CODE: D 2866 LF16 MTR-CODE: D 2866 LF16; REQ: 2 REQ: 2	AVX 13 x 1450 TM AVX 13 x 1450 TM AVX 13 x 1225 TM

<b>19.422</b>						
11967 ccm	309 kW	D 2866 LF06;D 2866 LF09	02.90 - 06.96	AC-C AC-C HYD-P HYD-P W-P W-P W-P W-P	MTR-CODE: D 2866 LF06 UNTIL: 05.95; MTR-CODE: D 2866 LF06 MTR-CODE: D 2866 LF06; REQ: 2 UNTIL: 05.95; MTR-CODE: D 2866 LF06; REQ: 2 MTR-CODE: D 2866 LF06; REQ: 2 UNTIL: 05.95; MTR-CODE: D 2866 LF06; REQ: 2 MTR-CODE: D 2866 LF06; REQ: 2 MTR-CODE: D 2866 LF06	AVX 13 x 1450 TM AVX 13 x 1450 TM AVX 13 x 1450 TM AVX 13 x 1450 TM AVX 13 x 1225 TM AVX 13 x 1225 TM AVX 13 x 1225 TM AVX 13 x 1450 TM AVX 13 x 1450 TM
		D 2866 LF06;D 2866 LF09;D 2866 LF10		AC-C	MTR-CODE: D 2866 LF06	AVX 13 x 1450 TM
				HYD-P W-P	MTR-CODE: D 2866 LF06; REQ: 2 MTR-CODE: D 2866 LF06; REQ: 2	AVX 13 x 1450 TM AVX 13 x 1225 TM

<b>19.462</b>						
18273 ccm	338 kW	D 2840 LF/460	05.87 - 02.90	AC-C AC-C ALT	MTR-CODE: D 2840 LF;460; MOD: 19.462 F;19.462 FL MTR-CODE: D 2840 LF;460; MOD: 19.462 F;19.462 FL MTR-CODE: D 2840 LF;460; MOD: 19.462 F;19.462 FL; QTY: 1	<b>10 x 1822</b> AVX 13 x 1325 TM AVX 13 x 1550 TM AVX 13 x 1825 TM

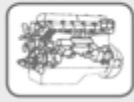

## MAN

F 90						
<b>19.462</b>						
18273 ccm	338 kW	D 2840 LF/460	05.87 - 02.90	ALT FAN	REQ: 2 MTR-CODE: D 2840 LF;460; MOD: 19.462 F;19.462 FL; REQ: 3	<b>10 x 1822</b> <b>AVX 13 x 1275 TM</b>
				FAN		<b>3/AVX 13 x 1275</b>
<b>19.502</b>						
18273 ccm	368 kW	D 2840 LF01;D 2840 LF04;D 2840 LF06	02.90 - 06.96	AC-C	MTR-CODE: D 2840 LF01	<b>AVX 13 x 1325 TM</b>
				AC-C	MTR-CODE: D 2840 LF01	<b>AVX 13 x 1550 TM</b>
				ALT	MTR-CODE: D 2840 LF01; QTY: 1	<b>AVX 13 x 1825 TM</b>
				ALT	REQ: 2	<b>10 x 1822</b>
				FAN	MTR-CODE: D 2840 LF01; REQ: 3	<b>AVX 13 x 1275 TM</b>
				FAN		<b>3/AVX 13 x 1275</b>
<b>24.242</b>						
11967 ccm	177 kW	D 2866 F/240	01.88 - 02.90	AC-C	MTR-CODE: D 2866 F;240; MOD: 24.242 DF; REQ: 2	<b>AVX 13 x 1450 TM</b>
				W-P	MTR-CODE: D 2866 F;240; MOD: 24.242 DF; REQ: 2	<b>AVX 13 x 1225 TM</b>
<b>24.262</b>						
9973 ccm	191 kW	D 2865 LF/260	01.88 - 02.90	AC-C	MTR-CODE: D 2865 LF;260; MOD: 24.262 DF; REQ: 2	<b>AVX 13 x 1450 TM</b>
				W-P	MTR-CODE: D 2865 LF;260; MOD: 24.262 DF; REQ: 2	<b>AVX 13 x 1225 TM</b>
<b>24.272</b>						
9973 ccm	198 kW	D 2865 LF02	02.90 - 05.95	AC-C		<b>AVX 13 x 1450 TM</b>
				ALT		<b>AVX 13 x 1475 TM</b>
				ALT	UNTIL: 06.93	<b>AVX 13 x 1475 TM</b>
				HYD-P	REQ: 2	<b>AVX 13 x 1425 TM</b>
				W-P	REQ: 2	<b>AVX 13 x 1225 TM</b>
		D 2865 LF02;D 2865 LF05		AC-C	MTR-CODE: D 2865 LF02	<b>AVX 13 x 1450 TM</b>
				ALT	UNTIL: 06.93; MTR-CODE: D 2865 LF02	<b>AVX 13 x 1475 TM</b>
				HYD-P	MTR-CODE: D 2865 LF02; REQ: 2	<b>AVX 13 x 1425 TM</b>
				W-P	MTR-CODE: D 2865 LF02; REQ: 2	<b>AVX 13 x 1225 TM</b>
<b>24.292</b>						
11967 ccm	213 kW	D 2866 LF/290	10.86 - 02.90	AC-C	MTR-CODE: D 2866 LF;290; MOD: 24.292 DF; REQ: 2	<b>AVX 13 x 1450 TM</b>
				W-P	MTR-CODE: D 2866 LF;290; MOD: 24.292 DF; REQ: 2	<b>AVX 13 x 1225 TM</b>
<b>24.302</b>						
11967 ccm	220 kW	D 2866 LF04	05.90 - 04.95	AC-C	MTR-CODE: D 2866 LF04; MOD: 24.302 DF	<b>AVX 13 x 1450 TM</b>
				HYD-P	MTR-CODE: D 2866 LF04; MOD: 24.302 DF; REQ: 2	<b>AVX 13 x 1450 TM</b>
				W-P	MOD: 24.302 DF; REQ: 2	<b>AVX 13 x 1225 TM</b>
<b>24.322</b>						
9973 ccm	235 kW	D 2865 LF03	02.90 - 05.95	AC-C		<b>AVX 13 x 1450 TM</b>
				ALT	REQ: 2	<b>AVX 13 x 1475 TM</b>
				HYD-P	REQ: 2	<b>AVX 13 x 1425 TM</b>
				W-P	REQ: 2	<b>AVX 13 x 1225 TM</b>
		D 2865 LF03;D 2865 LF06		AC-C	MTR-CODE: D 2865 LF03	<b>AVX 13 x 1450 TM</b>
				ALT	UNTIL: 06.93; MTR-CODE: D 2865 LF03; REQ: 2	<b>AVX 13 x 1475 TM</b>
				HYD-P	MTR-CODE: D 2865 LF03; REQ: 2	<b>AVX 13 x 1425 TM</b>
				W-P	MTR-CODE: D 2865 LF03; REQ: 2	<b>AVX 13 x 1225 TM</b>
<b>24.332</b>						
11967 ccm	243 kW	D 2866 LF/330	10.86 - 02.90	AC-C	MTR-CODE: D 2866 LF;330; MOD: 24.332 DF; REQ: 2	<b>AVX 13 x 1450 TM</b>
				ALT	MTR-CODE: D 2866 LF;330; MOD: 24.332 DF; REQ: 2	<b>AVX 13 x 1475 TM</b>
				W-P	MTR-CODE: D 2866 LF;330; MOD: 24.332 DF; REQ: 2	<b>AVX 13 x 1225 TM</b>
<b>24.362</b>						
11967 ccm	265 kW	D 2866 KF;D 2866 LXF	10.86 - 02.90	ALT	MOD: 24.362 DF	<b>AVX 13 x 1475 TM</b>
				HYD-P	MOD: 24.362 DF; REQ: 2	<b>AVX 13 x 1450 TM</b>
				W-P	MOD: 24.362 DF; REQ: 2	<b>AVX 13 x 1225 TM</b>
<b>24.372</b>						
11967 ccm	272 kW	D 2866 LF03	02.90 - 05.95	AC-C	MTR-CODE: D 2866 LF03; MOD: 24.372 DF	<b>AVX 13 x 1450 TM</b>
				HYD-P	MTR-CODE: D 2866 LF03; MOD: 24.372 DF; REQ: 2	<b>AVX 13 x 1450 TM</b>
				W-P	MOD: 24.372 DF; REQ: 2	<b>AVX 13 x 1225 TM</b>
		D 2866 LF03;D 2866 LF15		AC-C	MTR-CODE: D 2866 LF03; MOD: 24.372 DF	<b>AVX 13 x 1450 TM</b>

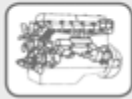

## MAN

### F 90

#### 24.372

11967 ccm	272 kW	D 2866 LF03;D 2866 LF15	02.90 - 05.95	HYD-P	MTR-CODE: D 2866 LF03; MOD: 24.372 DF; REQ: 2	AVX 13 x 1450 TM
				W-P	MTR-CODE: D 2866 LF03; MOD: 24.372 DF; REQ: 2	AVX 13 x 1225 TM

#### 24.422

11967 ccm	309 kW	D 2866 LF06	02.90 - 05.95	AC-C	MTR-CODE: D 2866 LF06	AVX 13 x 1450 TM
				HYD-P	MTR-CODE: D 2866 LF06; REQ: 2	AVX 13 x 1450 TM
				W-P	REQ: 2	AVX 13 x 1225 TM
		D 2866 LF06;D 2866 LF09		AC-C	MTR-CODE: D 2866 LF06	AVX 13 x 1450 TM
				HYD-P	MTR-CODE: D 2866 LF06; REQ: 2	AVX 13 x 1450 TM
				W-P	MTR-CODE: D 2866 LF06; REQ: 2	AVX 13 x 1225 TM

#### 24.462

18273 ccm	338 kW	D 2840 LF/460	05.87 - 02.90	AC-C	MTR-CODE: D 2840 LF;460; MOD: 24.462 DF	AVX 13 x 1325 TM
				AC-C	MTR-CODE: D 2840 LF;460; MOD: 24.462 DF	AVX 13 x 1550 TM
				ALT	MTR-CODE: D 2840 LF;460; MOD: 24.462 DF; QTY: 1	AVX 13 x 1825 TM
				FAN	MTR-CODE: D 2840 LF;460; MOD: 24.462 DF; REQ: 3	AVX 13 x 1275 TM

#### 24.502

18273 ccm	368 kW	D 2840 LF01	02.90 - 12.90	AC-C	MOD: 24.502 DF	AVX 13 x 1325 TM
				AC-C	MOD: 24.502 DF	AVX 13 x 1550 TM
				ALT	MOD: 24.502 DF; QTY: 1	AVX 13 x 1825 TM
				ALT	REQ: 2	10 x 1822
				FAN	MOD: 24.502 DF; REQ: 3	AVX 13 x 1275 TM
				FAN		3/AVX 13 x 1275

#### 25.272

9973 ccm	198 kW	D 2865 LF02;D 2865 LF05	09.90 - 10.93	AC-C	MTR-CODE: D 2865 LF02; MOD: 25.272 DF	AVX 13 x 1450 TM
				ALT	MTR-CODE: D 2865 LF02; MOD: 25.272 DF	AVX 13 x 1475 TM
				ALT	UNTIL: 06.93; MTR-CODE: D 2865 LF02; MOD: 25.272 DF	AVX 13 x 1475 TM
				HYD-P	MTR-CODE: D 2865 LF02; MOD: 25.272 DF; REQ: 2	AVX 13 x 1425 TM
				W-P	MTR-CODE: D 2865 LF02; MOD: 25.272 DF; REQ: 2	AVX 13 x 1225 TM

#### 25.302

11967 ccm	220 kW	D 2866 LF04	09.90 - 12.91	AC-C	MTR-CODE: D 2866 LF04; MOD: 25.302 DF	AVX 13 x 1450 TM
				HYD-P	MTR-CODE: D 2866 LF04; MOD: 25.302 DF; REQ: 2	AVX 13 x 1450 TM
				W-P	MOD: 25.302 DF; REQ: 2	AVX 13 x 1225 TM

#### 25.322

9973 ccm	235 kW	D 2865 LF03;D 2865 LF06	09.90 - 12.92	AC-C	MTR-CODE: D 2865 LF03; MOD: 25.322 DF	AVX 13 x 1450 TM
				ALT	MTR-CODE: D 2865 LF03; MOD: 25.322 DF; REQ: 2	AVX 13 x 1475 TM
				HYD-P	MTR-CODE: D 2865 LF03; MOD: 25.322 DF; REQ: 2	AVX 13 x 1425 TM
				W-P	MTR-CODE: D 2865 LF03; MOD: 25.322 DF; REQ: 2	AVX 13 x 1225 TM

#### 25.372

11967 ccm	272 kW	D 2866 LF03;D 2866 LF05	09.90 - 10.93	AC-C	MTR-CODE: D 2866 LF03; MOD: 25.372 DF	AVX 13 x 1450 TM
				HYD-P	MTR-CODE: D 2866 LF03; MOD: 25.372 DF; REQ: 2	AVX 13 x 1450 TM
				W-P	MTR-CODE: D 2866 LF03; MOD: 25.372 DF; REQ: 2	AVX 13 x 1225 TM

#### 25.422

11967 ccm	309 kW	D 2866 LF06;D 2866 LF09	09.90 - 12.92	AC-C	MTR-CODE: D 2866 LF06; MOD: 25.422 DF	AVX 13 x 1450 TM
				HYD-P	MTR-CODE: D 2866 LF06; MOD: 25.422 DF; REQ: 2	AVX 13 x 1450 TM
				W-P	MTR-CODE: D 2866 LF06; MOD: 25.422 DF; REQ: 2	AVX 13 x 1225 TM

#### 25.502

18273 ccm	368 kW	D 2840 LF01;D 2840 LF04	09.90 - 12.92	ALT	REQ: 2	10 x 1822
				FAN		3/AVX 13 x 1275

#### 26.262

9973 ccm	191 kW	D 2865 LF/260	01.88 - 02.90	AC-C	MTR-CODE: D 2865 LF;260; MOD: 26.262 DF; REQ: 2	AVX 13 x 1450 TM
				W-P	MTR-CODE: D 2865 LF;260; MOD: 26.262 DF; REQ: 2	AVX 13 x 1225 TM

#### 26.272

9973 ccm	198 kW	D 2865 LF02;D 2865 LF05	02.90 - 06.96	AC-C	MTR-CODE: D 2865 LF02; MOD: 26.272 DF	AVX 13 x 1450 TM
----------	--------	-------------------------	---------------	------	---------------------------------------	------------------

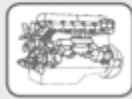

## MAN

### F 90

26.272						
9973 ccm	198 kW	D 2865 LF02;D 2865 LF05	02.90 - 06.96	ALT	MTR-CODE: D 2865 LF02; MOD: 26.272 DF	AVX 13 x 1475 TM
				ALT	UNTIL: 06.93; MTR-CODE: D 2865 LF02; MOD: 26.272 DF	AVX 13 x 1475 TM
				HYD-P	MTR-CODE: D 2865 LF02; MOD: 26.272 DF; REQ: 2	AVX 13 x 1425 TM
				W-P	MTR-CODE: D 2865 LF02; MOD: 26.272 DF; REQ: 2	AVX 13 x 1225 TM
		D 2865 LF05		AC-C	MTR-CODE: D 2865 LF02; MOD: 26.272 DF	AVX 13 x 1450 TM
				ALT	UNTIL: 06.93; MTR-CODE: D 2865 LF02; MOD: 26.272 DF	AVX 13 x 1475 TM
				HYD-P	MTR-CODE: D 2865 LF02; MOD: 26.272 DF; REQ: 2	AVX 13 x 1425 TM
				W-P	MTR-CODE: D 2865 LF02; MOD: 26.272 DF; REQ: 2	AVX 13 x 1225 TM
26.292						
11967 ccm	213 kW	D 2866 LF/290	09.87 - 02.90	AC-C	MTR-CODE: D 2866 LF;290; MOD: 26.292 DF; REQ: 2	AVX 13 x 1450 TM
				W-P	MTR-CODE: D 2866 LF;290; MOD: 26.292 DF; REQ: 2	AVX 13 x 1225 TM
26.302						
11967 ccm	220 kW	D 2866 LF04	05.90 - 12.91	AC-C	MTR-CODE: D 2866 LF04; MOD: 26.302 DF	AVX 13 x 1450 TM
				HYD-P	MTR-CODE: D 2866 LF04; MOD: 26.302 DF; REQ: 2	AVX 13 x 1450 TM
				W-P	MOD: 26.302 DF; REQ: 2	AVX 13 x 1225 TM
26.322						
9973 ccm	235 kW	D 2865 LF03;D 2865 LF06	02.90 - 06.96	AC-C	MTR-CODE: D 2865 LF03; MOD: 26.322 DF	AVX 13 x 1450 TM
				ALT	MTR-CODE: D 2865 LF03; MOD: 26.322 DF; REQ: 2	AVX 13 x 1475 TM
				ALT	UNTIL: 06.93; MTR-CODE: D 2865 LF03; MOD: 26.322 DF; REQ: 2	AVX 13 x 1475 TM
				HYD-P	MTR-CODE: D 2865 LF03; MOD: 26.322 DF; REQ: 2	AVX 13 x 1425 TM
				W-P	MTR-CODE: D 2865 LF03; MOD: 26.322 DF; REQ: 2	AVX 13 x 1225 TM
26.332						
11967 ccm	243 kW	D 2866 LF/330	09.87 - 02.90	AC-C	MTR-CODE: D 2866 LF;330; MOD: 26.332 DF; REQ: 2	AVX 13 x 1450 TM
				W-P	MTR-CODE: D 2866 LF;330; MOD: 26.332 DF; REQ: 2	AVX 13 x 1225 TM
26.342						
9973 ccm	250 kW	D 2865 LF09	04.94 - 06.96	AC-C		AVX 13 x 1425 TM
				AC-C	MTR-CODE: D 2865 LF09; OE-NO.: 06580722392	AVX 13 x 1450 TM
				AC-C	OE-NO.: 06580722402	AVX 13 x 1475 TM
				HYD-P	MTR-CODE: D 2865 LF09; REQ: 2	AVX 13 x 1450 TM
				W-P	REQ: 2	AVX 13 x 1225 TM
26.362						
11967 ccm	265 kW	D 2866 KF;D 2866 LXF	09.87 - 02.90	ALT	MTR-CODE: D 2866 KF	AVX 13 x 1475 TM
				HYD-P	MTR-CODE: D 2866 KF; REQ: 2	AVX 13 x 1450 TM
				W-P	MTR-CODE: D 2866 KF; REQ: 2	AVX 13 x 1225 TM
		D 2866 LXF		ALT	MTR-CODE: D 2866 KF	AVX 13 x 1475 TM
				HYD-P	MTR-CODE: D 2866 KF; REQ: 2	AVX 13 x 1450 TM
				W-P	MTR-CODE: D 2866 KF; REQ: 2	AVX 13 x 1225 TM
26.372						
11967 ccm	272 kW	D 2866 LF03;D 2866 LF05	02.90 - 06.96	AC-C	MTR-CODE: D 2866 LF03	AVX 13 x 1450 TM
				HYD-P	MTR-CODE: D 2866 LF03; REQ: 2	AVX 13 x 1450 TM
				W-P	MTR-CODE: D 2866 LF03; REQ: 2	AVX 13 x 1225 TM
		D 2866 LF03;D 2866 LF05;D 2866 LF15		AC-C	MTR-CODE: D 2866 LF03	AVX 13 x 1450 TM
				HYD-P	MTR-CODE: D 2866 LF03; REQ: 2	AVX 13 x 1450 TM
				W-P	MTR-CODE: D 2866 LF03; REQ: 2	AVX 13 x 1225 TM
26.402						
11967 ccm	294 kW	D 2866 LF16	05.94 - 06.96	AC-C	MTR-CODE: D 2866 LF16	AVX 13 x 1450 TM
				HYD-P	MTR-CODE: D 2866 LF16; REQ: 2	AVX 13 x 1450 TM
				W-P	REQ: 2	AVX 13 x 1225 TM
26.422						
11967 ccm	309 kW	D 2866 LF06;D 2866 LF09	02.90 - 06.96	AC-C	MTR-CODE: D 2866 LF06	AVX 13 x 1450 TM
				HYD-P	MTR-CODE: D 2866 LF06; REQ: 2	AVX 13 x 1450 TM
				W-P	MTR-CODE: D 2866 LF06; REQ: 2	AVX 13 x 1225 TM



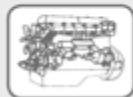

## MAN

### F 90

#### 26.462

18273 ccm	338 kW	D 2840 LF/460	02.89 - 02.90	AC-C	MTR-CODE: D 2840 LF;460; MOD: 26.462 DF	AVX 13 x 1325 TM
				AC-C	MTR-CODE: D 2840 LF;460; MOD: 26.462 DF	AVX 13 x 1550 TM
				ALT	MTR-CODE: D 2840 LF;460; MOD: 26.462 DF; QTY: 1	AVX 13 x 1825 TM
				FAN	MTR-CODE: D 2840 LF;460; MOD: 26.462 DF; REQ: 3	AVX 13 x 1275 TM

#### 26.502

18273 ccm	368 kW	D 2840 LF01;D 2840 LF04	02.90 - 06.96	AC-C	MTR-CODE: D 2840 LF01; MOD: 26.502 DF	AVX 13 x 1325 TM
				AC-C	MTR-CODE: D 2840 LF01; MOD: 26.502 DF	AVX 13 x 1550 TM
				ALT	MTR-CODE: D 2840 LF01; MOD: 26.502 DF; QTY: 1	AVX 13 x 1825 TM
				FAN	MTR-CODE: D 2840 LF01; MOD: 26.502 DF; REQ: 3	AVX 13 x 1275 TM
		D 2840 LF01;D 2840 LF04;D 2840 LF06		AC-C	MTR-CODE: D 2840 LF01; MOD: 26.502 DF	AVX 13 x 1325 TM
				AC-C	MTR-CODE: D 2840 LF01; MOD: 26.502 DF	AVX 13 x 1550 TM
				ALT	MTR-CODE: D 2840 LF01; MOD: 26.502 DF; QTY: 1	AVX 13 x 1825 TM
				FAN	MTR-CODE: D 2840 LF01; MOD: 26.502 DF; REQ: 3	AVX 13 x 1275 TM
		D 2840 LF04;D 2840 LF06		AC-C	MTR-CODE: D 2840 LF01; MOD: 26.502 DF	AVX 13 x 1325 TM
				AC-C	MTR-CODE: D 2840 LF01; MOD: 26.502 DF	AVX 13 x 1550 TM
				ALT	MTR-CODE: D 2840 LF01; MOD: 26.502 DF; QTY: 1	AVX 13 x 1825 TM
				FAN	MTR-CODE: D 2840 LF01; MOD: 26.502 DF; REQ: 3	AVX 13 x 1275 TM

#### 32.262

9973 ccm	191 kW	D 2865 LF/260	02.89 - 02.90	AC-C	MTR-CODE: D 2865 LF;260; MOD: 32.262 VF; REQ: 2	AVX 13 x 1450 TM
				W-P	MTR-CODE: D 2865 LF;260; MOD: 32.262 VF; REQ: 2	AVX 13 x 1225 TM

#### 32.272

9973 ccm	198 kW	D 2865 LF02;D 2865 LF05	02.90 - 04.95	AC-C	MTR-CODE: D 2865 LF02; MOD: 32.272 VF;32.272 VFK	AVX 13 x 1450 TM
				ALT	UNTIL: 06.93; MTR-CODE: D 2865 LF02; MOD: 32.272 VF;32.272 VFK	AVX 13 x 1475 TM
				HYD-P	MTR-CODE: D 2865 LF02; MOD: 32.272 VF;32.272 VFK; REQ: 2	AVX 13 x 1425 TM
				W-P	MTR-CODE: D 2865 LF02; MOD: 32.272 VF;32.272 VFK; REQ: 2	AVX 13 x 1225 TM

#### 32.292

11967 ccm	213 kW	D 2866 LF/290	03.88 - 02.90	AC-C	MTR-CODE: D 2866 LF;290; MOD: 32.292 VF;32.292 VFK; REQ: 2	AVX 13 x 1450 TM
				W-P	MTR-CODE: D 2866 LF;290; MOD: 32.292 VF;32.292 VFK; REQ: 2	AVX 13 x 1225 TM

#### 32.302

11967 ccm	220 kW	D 2866 LF04	05.90 - 09.91	AC-C	MTR-CODE: D 2866 LF04; MOD: 32.302 VF;32.302 VFK	AVX 13 x 1450 TM
				HYD-P	MTR-CODE: D 2866 LF04; MOD: 32.302 VF;32.302 VFK; REQ: 2	AVX 13 x 1450 TM
				W-P	MOD: 32.302 VF;32.302 VFK; REQ: 2	AVX 13 x 1225 TM

#### 32.322

9973 ccm	235 kW	D 2865 LF03;D 2865 LF06	02.90 - 06.96	AC-C	MTR-CODE: D 2865 LF03; MOD: 32.322 VF;32.322 VFK	AVX 13 x 1450 TM
				ALT	UNTIL: 06.93; MTR-CODE: D 2865 LF03; MOD: 32.322 VF;32.322 VFK; REQ: 2	AVX 13 x 1475 TM
				HYD-P	MTR-CODE: D 2865 LF03; MOD: 32.322 VF;32.322 VFK; REQ: 2	AVX 13 x 1425 TM
				W-P	MTR-CODE: D 2865 LF03; MOD: 32.322 VF;32.322 VFK; REQ: 2	AVX 13 x 1225 TM

#### 32.332

11967 ccm	243 kW	D 2866 LF/330	03.88 - 02.90	AC-C	MTR-CODE: D 2866 LF;330; MOD: 32.332 VF;32.332 VFK; REQ: 2	AVX 13 x 1450 TM
				W-P	MTR-CODE: D 2866 LF;330; MOD: 32.332 VF;32.332 VFK; REQ: 2	AVX 13 x 1225 TM

#### 32.342

9973 ccm	250 kW	D 2865 LF09	05.94 - 06.96	AC-C	MOD: 32.342 VFK	AVX 13 x 1425 TM
				AC-C	OE-NO.: 06580722402; MOD: 32.342 VFK	AVX 13 x 1475 TM
				HYD-P	MTR-CODE: D 2865 LF09; MOD: 32.342 VFK; REQ: 2	AVX 13 x 1450 TM

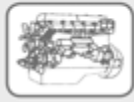
**MAN**

F 90						
<b>32.342</b>						
9973 ccm	250 kW	D 2865 LF09	05.94 - 06.96	HYD-P	MTR-CODE: D 2865 LF09; OE-NO.: 06580722392; MOD: 32.342 VFK	AVX 13 x 1450 TM
				W-P	MOD: 32.342 VFK; REQ: 2	AVX 13 x 1225 TM
<b>32.362</b>						
11967 ccm	265 kW	D 2866 LXF	03.88 - 02.90	ALT	MOD: 32.362 VF;32.362 VFK	AVX 13 x 1475 TM
				HYD-P	MOD: 32.362 VF;32.362 VFK; REQ: 2	AVX 13 x 1450 TM
				W-P	MOD: 32.362 VF;32.362 VFK; REQ: 2	AVX 13 x 1225 TM
<b>32.372</b>						
11967 ccm	272 kW	D 2866 LF03;D 2866 LF05;D 2866 LF15	02.90 - 06.96	AC-C	MTR-CODE: D 2866 LF03; MOD: 32.372 VF;32.372 VFK	AVX 13 x 1450 TM
				HYD-P	MTR-CODE: D 2866 LF03; MOD: 32.372 VF;32.372 VFK; REQ: 2	AVX 13 x 1450 TM
				W-P	MTR-CODE: D 2866 LF03; MOD: 32.372 VF;32.372 VFK; REQ: 2	AVX 13 x 1225 TM
<b>32.402</b>						
11967 ccm	294 kW	D 2866 LF16	05.94 - 06.96	AC-C	MTR-CODE: D 2866 LF16; MOD: 32.402 VFK	AVX 13 x 1450 TM
				HYD-P	MTR-CODE: D 2866 LF16; MOD: 32.402 VFK; REQ: 2	AVX 13 x 1450 TM
				W-P	MOD: 32.402 VFK; REQ: 2	AVX 13 x 1225 TM
<b>32.422</b>						
11967 ccm	309 kW	D 2866 LF06;D 2866 LF09	02.90 - 06.96	AC-C	MTR-CODE: D 2866 LF06; MOD: 32.422 VF	AVX 13 x 1450 TM
				HYD-P	MTR-CODE: D 2866 LF06; MOD: 32.422 VF; REQ: 2	AVX 13 x 1450 TM
				W-P	MTR-CODE: D 2866 LF06; MOD: 32.422 VF; REQ: 2	AVX 13 x 1225 TM
<b>33.272</b>						
9973 ccm	191-198 kW	D 2865 LF05	10.92 - 04.95	AC-C	MOD: 33.272 FVL	AVX 13 x 1450 TM
				ALT	UNTIL: 06.93; MOD: 33.272 FVL	AVX 13 x 1475 TM
				HYD-P	MOD: 33.272 FVL; REQ: 2	AVX 13 x 1425 TM
				W-P	MOD: 33.272 FVL; REQ: 2	AVX 13 x 1225 TM
	198 kW			AC-C	MOD: 33.272 DF;33.272 DFA	AVX 13 x 1450 TM
				ALT	UNTIL: 06.93; MOD: 33.272 DF;33.272 DFA	AVX 13 x 1475 TM
				HYD-P	MOD: 33.272 DF;33.272 DFA; REQ: 2	AVX 13 x 1425 TM
				W-P	MOD: 33.272 DF;33.272 DFA; REQ: 2	AVX 13 x 1225 TM
<b>33.292</b>						
11967 ccm	213 kW	D 2866 LF/290	09.87 - 02.90	AC-C	MTR-CODE: D 2866 LF;290; MOD: 33.292 DF; REQ: 2	AVX 13 x 1450 TM
				W-P	MTR-CODE: D 2866 LF;290; MOD: 33.292 DF; REQ: 2	AVX 13 x 1225 TM
<b>33.322</b>						
9973 ccm	235 kW	D 2865 LF03;D 2865 LF06	09.91 - 06.96	AC-C	MTR-CODE: D 2865 LF03; MOD: 33.322 DF	AVX 13 x 1450 TM
				ALT	UNTIL: 06.93; MTR-CODE: D 2865 LF03; MOD: 33.322 DF; REQ: 2	AVX 13 x 1475 TM
				HYD-P	MTR-CODE: D 2865 LF03; MOD: 33.322 DF; REQ: 2	AVX 13 x 1425 TM
				W-P	MTR-CODE: D 2865 LF03; MOD: 33.322 DF; REQ: 2	AVX 13 x 1225 TM
<b>33.332</b>						
9973 ccm	243 kW		09.87 - 02.90	AC-C	MTR-CODE: D 2866 LF;330; MOD: 33.332 DF; REQ: 2	AVX 13 x 1450 TM
				W-P	MTR-CODE: D 2866 LF;330; MOD: 33.332 DF; REQ: 2	AVX 13 x 1225 TM
11967 ccm		D 2866 LF/330		AC-C	MTR-CODE: D 2866 LF;330; MOD: 33.332 DFA; REQ: 2	AVX 13 x 1450 TM
				W-P	MTR-CODE: D 2866 LF;330; MOD: 33.332 DFA; REQ: 2	AVX 13 x 1225 TM
<b>33.372</b>						
11967 ccm	272 kW	D 2866 LF03;D 2866 LF05;D 2866 LF15	01.91 - 06.96	AC-C	MTR-CODE: D 2866 LF03; MOD: 33.372 DF	AVX 13 x 1450 TM
				HYD-P	MTR-CODE: D 2866 LF03; MOD: 33.372 DF; REQ: 2	AVX 13 x 1450 TM
				W-P	MTR-CODE: D 2866 LF03; MOD: 33.372 DF; REQ: 2	AVX 13 x 1225 TM
<b>33.422</b>						
11967 ccm	309 kW	D 2866 LF06;D 2866 LF09	09.91 - 06.96	AC-C	MTR-CODE: D 2866 LF06; MOD: 33.422 DF	AVX 13 x 1450 TM
				HYD-P	MTR-CODE: D 2866 LF06; MOD: 33.422 DF; REQ: 2	AVX 13 x 1450 TM
				W-P	MTR-CODE: D 2866 LF06; MOD: 33.422 DF; REQ: 2	AVX 13 x 1225 TM

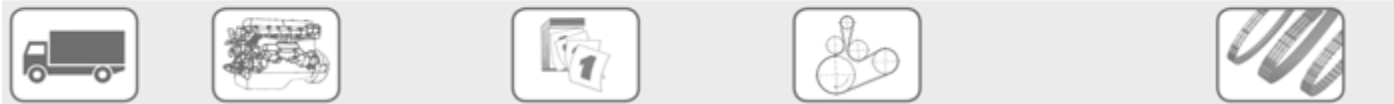

## MAN

### F 90

#### 33.462

18273 ccm	338 kW	D 2840 LF/460	07.89 - 02.90	AC-C	MTR-CODE: D 2840 LF;460; MOD: 33.462 DF;33.462 DFA	AVX 13 x 1325 TM
				AC-C	MTR-CODE: D 2840 LF;460; MOD: 33.462 DF;33.462 DFA	AVX 13 x 1550 TM
				ALT	MTR-CODE: D 2840 LF;460; MOD: 33.462 DF;33.462 DFA; QTY: 1	AVX 13 x 1825 TM
				FAN	MTR-CODE: D 2840 LF;460; MOD: 33.462 DF;33.462 DFA; REQ: 3	AVX 13 x 1275 TM

#### 33.502

18273 ccm	368 kW	D 2840 LF01;D 2840 LF04;D 2840 LF06	09.91 - 06.96	AC-C	MTR-CODE: D 2840 LF01; MOD: 33.502 DF;33.502 DFA	AVX 13 x 1325 TM
				AC-C	MTR-CODE: D 2840 LF01; MOD: 33.502 DF;33.502 DFA	AVX 13 x 1550 TM
				ALT	MTR-CODE: D 2840 LF01; MOD: 33.502 DF;33.502 DFA; QTY: 1	AVX 13 x 1825 TM
				FAN	MTR-CODE: D 2840 LF01; MOD: 33.502 DF;33.502 DFA; REQ: 3	AVX 13 x 1275 TM

#### 35.272

9973 ccm	198 kW	D 2865 LF02	02.90 - 12.92	AC-C	MOD: 35.272 VF;35.272 VFK	AVX 13 x 1450 TM
				ALT	MOD: 35.272 VF;35.272 VFK	AVX 13 x 1475 TM
				HYD-P	MOD: 35.272 VF;35.272 VFK; REQ: 2	AVX 13 x 1425 TM
				W-P	MOD: 35.272 VF;35.272 VFK; REQ: 2	AVX 13 x 1225 TM

#### 35.302

11967 ccm	220 kW	D 2866 LF04	05.90 - 09.91	AC-C	MTR-CODE: D 2866 LF04; MOD: 35.302 VF	AVX 13 x 1450 TM
				HYD-P	MTR-CODE: D 2866 LF04; MOD: 35.302 VF; REQ: 2	AVX 13 x 1450 TM
				W-P	MOD: 35.302 VF; REQ: 2	AVX 13 x 1225 TM

#### 35.322

9973 ccm	235 kW	D 2865 LF03;D 2865 LF06	02.90 - 06.96	AC-C	MTR-CODE: D 2865 LF03; MOD: 35.322 VFAK	AVX 13 x 1450 TM
				ALT	UNTIL: 06.93; MTR-CODE: D 2865 LF03; MOD: 35.322 VFAK; REQ: 2	AVX 13 x 1475 TM
				HYD-P	MTR-CODE: D 2865 LF03; MOD: 35.322 VFAK; REQ: 2	AVX 13 x 1425 TM
				W-P	MTR-CODE: D 2865 LF03; MOD: 35.322 VFAK; REQ: 2	AVX 13 x 1225 TM

#### 35.332

11967 ccm	243 kW	D 2866 LFZ/330	10.88 - 04.95	AC-C	MTR-CODE: D 2866 LFZ;330; MOD: 35.332 VF;35.332 VFK; REQ: 2	AVX 13 x 1450 TM
				W-P	MTR-CODE: D 2866 LFZ;330; MOD: 35.332 VF;35.332 VFK; REQ: 2	AVX 13 x 1225 TM

#### 35.372

11967 ccm	272 kW	D 2866 LF03;D 2866 LF05;D 2866 LF15	02.90 - 12.97	AC-C	MTR-CODE: D 2866 LF03; MOD: 35.372 VF;35.372 VFK	AVX 13 x 1450 TM
				HYD-P	MTR-CODE: D 2866 LF03; MOD: 35.372 VF;35.372 VFK; REQ: 2	AVX 13 x 1450 TM
				W-P	MTR-CODE: D 2866 LF03; MOD: 35.372 VF;35.372 VFK; REQ: 2	AVX 13 x 1225 TM

#### 35.422

11967 ccm	309 kW	D 2866 LF06;D 2866 LF09	02.90 - 12.97	AC-C	MTR-CODE: D 2866 LF06; MOD: 35.422 VF;35.422 VFK	AVX 13 x 1450 TM
				HYD-P	MTR-CODE: D 2866 LF06; MOD: 35.422 VF;35.422 VFK; REQ: 2	AVX 13 x 1450 TM
				W-P	MTR-CODE: D 2866 LF06; MOD: 35.422 VF;35.422 VFK; REQ: 2	AVX 13 x 1225 TM

#### 40.462

18273 ccm	338 kW	D 2840 LF/460	07.89 - 02.90	AC-C	MTR-CODE: D 2840 LF;460; MOD: 40.462 DF;40.462 DFA	AVX 13 x 1325 TM
				AC-C	MTR-CODE: D 2840 LF;460; MOD: 40.462 DF;40.462 DFA	AVX 13 x 1550 TM
				ALT	MTR-CODE: D 2840 LF;460; MOD: 40.462 DF;40.462 DFA; QTY: 1	AVX 13 x 1825 TM
				FAN	MTR-CODE: D 2840 LF;460; MOD: 40.462 DF;40.462 DFA; REQ: 3	AVX 13 x 1275 TM

#### 40.502

18273 ccm	368 kW	D 2840 LF01;D 2840 LF04;D 2840 LF06	02.90 - 06.96	AC-C	MTR-CODE: D 2840 LF01; MOD: 40.502 DFA	AVX 13 x 1325 TM
				AC-C	MTR-CODE: D 2840 LF01; MOD: 40.502 DFA	AVX 13 x 1550 TM
				ALT	MTR-CODE: D 2840 LF01; MOD: 40.502 DFA; QTY: 1	AVX 13 x 1825 TM
				FAN	MTR-CODE: D 2840 LF01; MOD: 40.502 DFA; REQ: 3	AVX 13 x 1275 TM

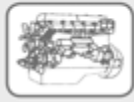

## MAN

### F 90

<b>41.292</b>						
11967 ccm	213 kW	D 2866 LF/290	10.88 - 02.90	AC-C	MTR-CODE: D 2866 LF;290; MOD: 41.292 VF;41.292 VFK; REQ: 2	<b>AVX 13 x 1450 TM</b>
				W-P	MTR-CODE: D 2866 LF;290; MOD: 41.292 VF;41.292 VFK; REQ: 2	<b>AVX 13 x 1225 TM</b>
<b>41.322</b>						
9973 ccm	235 kW	D 2865 LF03;D 2865 LF06	02.90 - 06.96	AC-C	MTR-CODE: D 2865 LF03; MOD: 41.322 VF UNTIL: 06.93; MTR-CODE: D 2865 LF03; MOD: 41.322 VF; REQ: 2	<b>AVX 13 x 1450 TM</b>
				ALT		<b>AVX 13 x 1475 TM</b>
				HYD-P	MTR-CODE: D 2865 LF03; MOD: 41.322 VF; REQ: 2	<b>AVX 13 x 1425 TM</b>
				W-P	MTR-CODE: D 2865 LF03; MOD: 41.322 VF; REQ: 2	<b>AVX 13 x 1225 TM</b>
<b>41.332</b>						
11967 ccm	243 kW	D 2866 LF/330	10.88 - 02.90	AC-C	MTR-CODE: D 2866 LF;330; MOD: 41.332 VF;41.332 VFK; REQ: 2	<b>AVX 13 x 1450 TM</b>
				W-P	MTR-CODE: D 2866 LF;330; MOD: 41.332 VF;41.332 VFK; REQ: 2	<b>AVX 13 x 1225 TM</b>
<b>41.372</b>						
11967 ccm	272 kW	D 2866 LF03;D 2866 LF05;D 2866 LF15	02.90 - 06.96	AC-C	MTR-CODE: D 2866 LF03; MOD: 41.372 VF	<b>AVX 13 x 1450 TM</b>
				HYD-P	MTR-CODE: D 2866 LF03; MOD: 41.372 VF; REQ: 2	<b>AVX 13 x 1450 TM</b>
				W-P	MTR-CODE: D 2866 LF03; MOD: 41.372 VF; REQ: 2	<b>AVX 13 x 1225 TM</b>
<b>41.422</b>						
11967 ccm	309 kW	D 2866 LF06;D 2866 LF09	02.90 - 06.96	AC-C	MTR-CODE: D 2866 LF06; MOD: 41.422 VF	<b>AVX 13 x 1450 TM</b>
				HYD-P	MTR-CODE: D 2866 LF06; MOD: 41.422 VF; REQ: 2	<b>AVX 13 x 1450 TM</b>
				W-P	MTR-CODE: D 2866 LF06; MOD: 41.422 VF; REQ: 2	<b>AVX 13 x 1225 TM</b>
<b>48.292</b>						
11967 ccm	213 kW	D 2866 LF/290	07.89 - 02.90	AC-C	MTR-CODE: D 2866 LF;290; MOD: 48.292 VF; REQ: 2	<b>AVX 13 x 1450 TM</b>
				W-P	MTR-CODE: D 2866 LF;290; MOD: 48.292 VF; REQ: 2	<b>AVX 13 x 1225 TM</b>
<b>48.332</b>						
11967 ccm	243 kW	D 2866 LF/330	07.89 - 02.90	AC-C	MTR-CODE: D 2866 LF; MOD: 47.332; REQ: 2	<b>AVX 13 x 1450 TM</b>
				AC-C	MTR-CODE: D 2866 LF;330; MOD: 48.332 VF; REQ: 2	<b>AVX 13 x 1450 TM</b>
				W-P	MTR-CODE: D 2866 LF; MOD: 47.332; REQ: 2	<b>AVX 13 x 1225 TM</b>
				W-P	MTR-CODE: D 2866 LF;330; MOD: 48.332 VF; REQ: 2	<b>AVX 13 x 1225 TM</b>
<b>48.462</b>						
18273 ccm	338 kW	D 2840 LF/460	07.89 - 02.90	AC-C	MTR-CODE: D 2840 LF;460; MOD: 48.462 VF	<b>AVX 13 x 1325 TM</b>
				AC-C	MTR-CODE: D 2840 LF;460; MOD: 48.462 VF	<b>AVX 13 x 1550 TM</b>
				ALT	MTR-CODE: D 2840 LF;460; MOD: 48.462 VF; QTY: 1	<b>AVX 13 x 1825 TM</b>
				FAN	MTR-CODE: D 2840 LF;460; MOD: 48.462 VF; REQ: 3	<b>AVX 13 x 1275 TM</b>

### G 90

<b>10.150</b>						
5687 ccm	92 kW	D 0226 MF	09.87 - 10.93	ALT		<b>AVX 10 x 1275</b>
6871 ccm	110-114 kW	D 0826 GF01;D 0826 GF03		AC-C	MTR-CODE: D 0826 GF01; MOD: 10.150 F;10.150 FL; REQ: 2	<b>AVX 13 x 1250 TM</b>
				AC-C	MTR-CODE: D 0826 GF01; MOD: 10.150 F;10.150 FL; REQ: 2	<b>AVX 13 x 1300 TM</b>
				ALT		<b>AVX 10 x 1275</b>
				HYD-P	MTR-CODE: D 0826 GF01; MOD: 10.150 F;10.150 FL; REQ: 2; - ADD-HYD-P / RAD-C	<b>AVX 13 x 1250 TM</b>
				HYD-P	MTR-CODE: D 0826 GF01; MOD: 10.150 F;10.150 FL; REQ: 2; + ADD-HYD-P / RAD-C	<b>AVX 13 x 1225 TM</b>
<b>6.100</b>						
4580 ccm	75 kW	D 0824 GF;D 0824 GF01;D 0824 GF02	09.87 - 10.93	AC-C	MTR-CODE: D 0824 GF; MOD: 6.100 F;6.100 FK; REQ: 2	<b>AVX 13 x 1250 TM</b>
				ALT		<b>AVX 10 x 1275</b>
<b>8.100</b>						
4580 ccm	75 kW	D 0824 GF;D 0824 GF01;D 0824 GF02	09.87 - 10.93	AC-C	MTR-CODE: D 0824 GF; MOD: 8.100 F;8.100 FK; REQ: 2	<b>AVX 13 x 1250 TM</b>
				ALT		<b>AVX 10 x 1275</b>



## MAN

### G 90

#### 8.150

5680 ccm	92 kW	D 0226 MF	09.87 - 05.95	ALT		<b>AVX 10 x 1275</b>
6871 ccm	110-114 kW	D 0826 GF;D 0826 GF03		AC-C	MTR-CODE: D 0826 GF; MOD: 8.150 F;8.150 FL; REQ: 2	<b>AVX 13 x 1250 TM</b>
				AC-C	MTR-CODE: D 0826 GF; MOD: 8.150 F;8.150 FL; REQ: 2	<b>AVX 13 x 1300 TM</b>
				ALT		<b>AVX 10 x 1275</b>
				HYD-P	MTR-CODE: D 0826 GF; MOD: 8.150 F;8.150 FL; REQ: 2; - ADD-HYD-P / RAD-C	<b>AVX 13 x 1250 TM</b>
				HYD-P	MTR-CODE: D 0826 GF; MOD: 8.150 F;8.150 FL; REQ: 2; + ADD-HYD-P / RAD-C	<b>AVX 13 x 1225 TM</b>
		D 0826 GF01;D 0826 GF03		ALT		<b>AVX 10 x 1275</b>
	110 kW	D 0826 GF03		AC-C	MTR-CODE: D 0826 GF; MOD: 8.150 F;8.150 FL; REQ: 2	<b>AVX 13 x 1250 TM</b>
				AC-C	MTR-CODE: D 0826 GF; MOD: 8.150 F;8.150 FL; REQ: 2	<b>AVX 13 x 1300 TM</b>
				ALT		<b>AVX 10 x 1275</b>
				HYD-P	MTR-CODE: D 0826 GF; MOD: 8.150 F;8.150 FL; REQ: 2; - ADD-HYD-P / RAD-C	<b>AVX 13 x 1250 TM</b>
				HYD-P	MTR-CODE: D 0826 GF; MOD: 8.150 F;8.150 FL; REQ: 2; + ADD-HYD-P / RAD-C	<b>AVX 13 x 1225 TM</b>

#### 9.150

5687 ccm	92 kW	D 0226 MF	09.87 - 05.95	ALT		<b>AVX 10 x 1275</b>
6871 ccm	110-114 kW	D 0826 GF;D 0826 GF03		AC-C	MTR-CODE: D 0826 GF; MOD: 9.150 FS;9.150 FLS; REQ: 2	<b>AVX 13 x 1250 TM</b>
				AC-C	MTR-CODE: D 0826 GF; MOD: 9.150 FS;9.150 FLS; REQ: 2	<b>AVX 13 x 1300 TM</b>
				ALT		<b>AVX 10 x 1275</b>
				HYD-P	MTR-CODE: D 0826 GF; MOD: 9.150 FS;9.150 FLS; REQ: 2; - ADD-HYD-P / RAD-C	<b>AVX 13 x 1250 TM</b>
				HYD-P	MTR-CODE: D 0826 GF; MOD: 9.150 FS;9.150 FLS; REQ: 2; + ADD-HYD-P / RAD-C	<b>AVX 13 x 1225 TM</b>
		D 0826 GF01;D 0826 GF03		ALT		<b>AVX 10 x 1275</b>
	110 kW	D 0826 GF03		AC-C	UNTIL: 10.93; MTR-CODE: D 0826 GF; MOD: 9.150 FS;9.150 FLS; REQ: 2	<b>AVX 13 x 1250 TM</b>
				AC-C	UNTIL: 10.93; MTR-CODE: D 0826 GF; MOD: 9.150 FS;9.150 FLS; REQ: 2	<b>AVX 13 x 1300 TM</b>
				ALT		<b>AVX 10 x 1275</b>
				HYD-P	UNTIL: 10.93; MTR-CODE: D 0826 GF; MOD: 9.150 FS;9.150 FLS; REQ: 2; - ADD-HYD-P / RAD-C	<b>AVX 13 x 1250 TM</b>
				HYD-P	UNTIL: 10.93; MTR-CODE: D 0826 GF; MOD: 9.150 FS;9.150 FLS; REQ: 2; + ADD-HYD-P / RAD-C	<b>AVX 13 x 1225 TM</b>

### HOCL

#### 18.240

6871 ccm 176 kW D 0836 LOH 52;D 0836 LOH 56 IN CON. WITH: Generator 28,5V 120A **8 PK 1158 TM**

#### 18.250

6871 ccm 184 kW D 0826 LOH 10;D 0836 LOH 61 08.93 - 05.01 IN CON. WITH: Generator 28,5V 120A **8 PK 1158 TM**

#### 18.280

6871 ccm 206 kW D 0836 LOH 01;D 0836 LOH 02;D 0836 LOH 51;D 0836 LOH 55 05.02 - 08.08 IN CON. WITH: Generator 28,5V 120A **8 PK 1158 TM**

#### 18.290

6871 ccm 213 kW D 0836 LOH 60 IN CON. WITH: Generator 28,5V 120A **8 PK 1158 TM**

#### 18.310

10518 ccm 228 kW D 2066 LUH 07;D 2066 LUH 12;D 2066 LUH 22 IN CON. WITH: Generator 28,5V 120A **8 PK 1158 TM**

12816 ccm E 2876 LUH 02 IN CON. WITH: Generator 28,5V 120A **8 PK 1158 TM**

#### 18.320

10518 ccm 235 kW D 2066 LUH 42 IN CON. WITH: Generator 28,5V 120A **8 PK 1158 TM**

### L 2000

#### 10.145

4580 ccm 103 kW D 0834 LFL 02 09.00 - AC-C REQ: 2 **AVX 13 x 1300 TM**  
HYD-P REQ: 2 **AVX 13 x 1375 TM**  
ALT OE-NO.: 51968200253 **12 PK 1300 TM**

#### 10.150

4580 ccm 114-118 kW D 0824 LFO 02.95 - 01.96 ALT **AVX 10 x 1400**

#### 10.153

4580 ccm 114 kW D 0824 LFL 01;D 0824 LFL 05 10.93 - AC-C **AVX 10 x 1250**

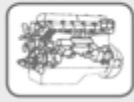

# MAN

## L 2000

10.153						
4580 ccm	114 kW	D 0824 LFL 01;D 0824 LFL 05	10.93 -	AC-C	MTR-CODE: D 0824 LFL 01; OE-NO.: 06580732312; MOD: 10.153 LLS; REQ: 2	AVX 13 x 1250 TM
				ALT		AVX 10 x 1350 TM
				HYD-P	MTR-CODE: D 0824 LFL 01; OE-NO.: 06580722342; MOD: 10.153 LLS; REQ: 2	AVX 13 x 1325 TM
				HYD-P	MTR-CODE: D 0824 LFL 01; OE-NO.: 06580732292; MOD: 10.153 LLS; REQ: 2	AVX 13 x 1200 TM
				HYD-P	MTR-CODE: D 0824 LFL 01; OE-NO.: 06580732362; MOD: 10.153 LLS; REQ: 2	AVX 13 x 1375 TM

10.163						
4580 ccm	114-118 kW	D 0824 LFL 02;D 0824 LFL 06;D 0824 LFL 09	05.94 -	AC-C	MTR-CODE: D 0824 LFL 02; OE-NO.: 06580732312; MOD: 10.163; REQ: 2	AVX 13 x 1250 TM
				ALT		AVX 10 x 1350 TM
				ALT	AMP: 35	AVX 10 x 1350 TM
				ALT	AMP: 35	AVX 10 x 1400
				HYD-P	MTR-CODE: D 0824 LFL 02; OE-NO.: 06580722342; MOD: 10.163; REQ: 2	AVX 13 x 1325 TM
				HYD-P	MTR-CODE: D 0824 LFL 02; OE-NO.: 06580732292; MOD: 10.163; REQ: 2	AVX 13 x 1200 TM
				HYD-P	MTR-CODE: D 0824 LFL 02; OE-NO.: 06580732362; MOD: 10.163; REQ: 2	AVX 13 x 1375 TM
	114 kW	D 0824 LFL 09		AC-C	MTR-CODE: D 0824 LFL 02; OE-NO.: 06580722342; MOD: 10.163; REQ: 2	AVX 13 x 1325 TM
				AC-C	MTR-CODE: D 0824 LFL 02; OE-NO.: 06580732312; MOD: 10.163; REQ: 2	AVX 13 x 1250 TM
				ALT	MTR-CODE: D 0824 LFL 02; OE-NO.: 06580732292; MOD: 10.163; REQ: 2	AVX 13 x 1200 TM
				ALT	MTR-CODE: D 0824 LFL 02; OE-NO.: 06580732362; MOD: 10.163; REQ: 2	AVX 13 x 1375 TM
				HYD-P	MTR-CODE: D 0824 LFL 02; OE-NO.: 06580732362; MOD: 10.163; REQ: 2	AVX 13 x 1375 TM

10.185						
4580 ccm	132 kW	D 0834 LFL 03	09.00 -	AC-C	MOD: 10.185 LAEC; REQ: 2	AVX 13 x 1300 TM
				HYD-P	MOD: 10.185 LAEC; REQ: 2	AVX 13 x 1375 TM
				ALT	OE-NO.: 51968200253; MOD: 10.185LAEC	12 PK 1300 TM

10.223						
6871 ccm	162-169 kW	D 0826 LFL02;D 0826 LFL06	10.93 - 06.96	AC-C	MTR-CODE: D 0826 LFL02; OE-NO.: 06580732312; MOD: 10.223 LAEC; REQ: 2	AVX 13 x 1250 TM
				ALT		AVX 10 x 1350 TM
				ALT	AMP: 35	AVX 10 x 1350 TM
				ALT	AMP: 35	AVX 10 x 1400
				HYD-P	MTR-CODE: D 0826 LFL02; OE-NO.: 06580722342; MOD: 10.223 LAEC; REQ: 2	AVX 13 x 1325 TM
				HYD-P	MTR-CODE: D 0826 LFL02; OE-NO.: 06580732292; MOD: 10.223 LAEC; REQ: 2	AVX 13 x 1200 TM
				HYD-P	MTR-CODE: D 0826 LFL02; OE-NO.: 06580732362; MOD: 10.223 LAEC; REQ: 2	AVX 13 x 1375 TM
	162 kW	D 0826 LFL06		AC-C	MTR-CODE: D 0826 LFL02; OE-NO.: 06580732312; MOD: 10.223 LAEC; REQ: 2	AVX 13 x 1250 TM
				ALT		AVX 10 x 1350 TM
				ALT	AMP: 35	AVX 10 x 1400
				HYD-P	MTR-CODE: D 0826 LFL02; OE-NO.: 06580722342; MOD: 10.223 LAEC; REQ: 2	AVX 13 x 1325 TM
				HYD-P	MTR-CODE: D 0826 LFL02; OE-NO.: 06580732292; MOD: 10.223 LAEC; REQ: 2	AVX 13 x 1200 TM
				HYD-P	MTR-CODE: D 0826 LFL02; OE-NO.: 06580732362; MOD: 10.223 LAEC; REQ: 2	AVX 13 x 1375 TM

10.224						
6871 ccm	162 kW	D 0826 LFL03	05.94 -	AC-C	OE-NO.: 06580732312; MOD: 10.224 LAEC; REQ: 2	AVX 13 x 1250 TM
				ALT		AVX 10 x 1350 TM
				ALT	AMP: 35	AVX 10 x 1350 TM
				ALT	AMP: 35	AVX 10 x 1400
				HYD-P	MTR-CODE: D 0826 LFL03; OE-NO.: 06580732362; MOD: 10.224 LAEC; REQ: 2	AVX 13 x 1375 TM
				HYD-P	OE-NO.: 06580722342; MOD: 10.224 LAEC; REQ: 2	AVX 13 x 1325 TM
				HYD-P	OE-NO.: 06580732292; MOD: 10.224 LAEC; REQ: 2	AVX 13 x 1200 TM
		D 0826 LFL03;D 0826 LFL10		AC-C	OE-NO.: 06580732312; MOD: 10.224 LAEC; REQ: 2	AVX 13 x 1250 TM
				ALT		AVX 10 x 1350 TM



## MAN

### L 2000

#### 10.224

6871 ccm	162 kW	D 0826 LFL03;D 0826 LFL10	05.94 -	ALT	AMP: 35	AVX 10 x 1400
				HYD-P	MTR-CODE: D 0826 LFL03; OE-NO.: 06580732362; MOD: 10.224 LAEC; REQ: 2	AVX 13 x 1375 TM
				HYD-P	OE-NO.: 06580722342; MOD: 10.224 LAEC; REQ: 2	AVX 13 x 1325 TM
				HYD-P	OE-NO.: 06580732292; MOD: 10.224 LAEC; REQ: 2	AVX 13 x 1200 TM

#### 10.225

6871 ccm	162 kW	D 0836 LFL 02	09.00 -	AC-C	REQ: 2	AVX 13 x 1300 TM
				HYD-P	REQ: 2	AVX 13 x 1375 TM

#### 12.185

4580 ccm	132 kW	D 0834 LFL 03	09.99 -	AC-C	MOD: 12.185 LC; LLC; REQ: 2	AVX 13 x 1300 TM
				HYD-P	MOD: 12.185 LC; LLC; REQ: 2	AVX 13 x 1375 TM
				ALT	OE-NO.: 51968200253; MOD: 12.185LC,LLC	12 PK 1300 TM

#### 12.225

6871 ccm	162 kW	D 0836 LFL 02	09.99 -	AC-C	REQ: 2	AVX 13 x 1300 TM
				HYD-P	REQ: 2	AVX 13 x 1375 TM

#### 8.103

4580 ccm	75 kW	D 0824 FL 01	10.93 - 06.96	AC-C	MOD: 8.103 LK; REQ: 2	AVX 13 x 1250 TM
				HYD-P	MOD: 8.103 LK; REQ: 2	AVX 13 x 1200 TM

#### 8.113

4580 ccm	81 kW	D 0824 LFL 04	08.95 -	AC-C	OE-NO.: 06580732312; MOD: 8.113 LC;8.113 LLC; REQ: 2	AVX 13 x 1250 TM
				ALT		AVX 10 x 1400
				HYD-P	MTR-CODE: D 0824 LFL 04; OE-NO.: 06580732362; MOD: 8.113 LC;8.113 LLC; REQ: 2	AVX 13 x 1375 TM
				HYD-P	OE-NO.: 06580722342; MOD: 8.113 LC;8.113 LLC; REQ: 2	AVX 13 x 1325 TM
				HYD-P	OE-NO.: 06580732292; MOD: 8.113 LC;8.113 LLC; REQ: 2	AVX 13 x 1200 TM

#### 8.145

4580 ccm	103 kW	D 0834 LFL 02	07.00 -	AC-C	MOD: 8.145; REQ: 2	AVX 13 x 1300 TM
				HYD-P	MOD: 8.145; REQ: 2	AVX 13 x 1375 TM
				ALT	OE-NO.: 51968200253; MOD: 8.145	12 PK 1300 TM

#### 8.150

4580 ccm	114-118 kW	D 0824 LFO	02.95 -	ALT		AVX 10 x 1275
----------	------------	------------	---------	-----	--	---------------

#### 8.153

4580 ccm	114 kW	D 0824 LFL 01;D 0824 LFL 05	10.93 - 07.97	AC-C		AVX 10 x 1250
				AC-C	MTR-CODE: D 0824 LFL 01; OE-NO.: 06580732312; MOD: 8.153 LLS; REQ: 2	AVX 13 x 1250 TM
				AC-C	UNTIL: 06.96; MTR-CODE: D 0824 LFL 01; OE- NO.: 06580732312; MOD: 8.153 LLS; REQ: 2	AVX 13 x 1250 TM
				ALT		AVX 10 x 1350 TM
				HYD-P	MTR-CODE: D 0824 LFL 01; OE-NO.: 06580722342; MOD: 8.153 LLS; REQ: 2	AVX 13 x 1325 TM
				HYD-P	MTR-CODE: D 0824 LFL 01; OE-NO.: 06580732292; MOD: 8.153 LLS; REQ: 2	AVX 13 x 1200 TM
				HYD-P	MTR-CODE: D 0824 LFL 01; OE-NO.: 06580732362; MOD: 8.153 LLS; REQ: 2	AVX 13 x 1375 TM
				HYD-P	UNTIL: 06.96; MTR-CODE: D 0824 LFL 01; OE- NO.: 06580722342; MOD: 8.153 LLS; REQ: 2	AVX 13 x 1325 TM
				HYD-P	UNTIL: 06.96; MTR-CODE: D 0824 LFL 01; OE- NO.: 06580732292; MOD: 8.153 LLS; REQ: 2	AVX 13 x 1200 TM
				HYD-P	UNTIL: 06.96; MTR-CODE: D 0824 LFL 01; OE- NO.: 06580732362; MOD: 8.153 LLS; REQ: 2	AVX 13 x 1375 TM

#### 8.163

4580 ccm	104 kW	D 0824 LFL 07	05.94 -	AC-C	MTR-CODE: D 0824 LFL 02; OE-NO.: 06580732312; MOD: 8.163 LAEC; REQ: 2	AVX 13 x 1250 TM
				ALT		AVX 10 x 1350 TM
				ALT	AMP: 35	AVX 10 x 1400
				HYD-P	MTR-CODE: D 0824 LFL 02; OE-NO.: 06580722342; MOD: 8.163 LAEC; REQ: 2	AVX 13 x 1325 TM
				HYD-P	MTR-CODE: D 0824 LFL 02; OE-NO.: 06580732292; MOD: 8.163 LAEC; REQ: 2	AVX 13 x 1200 TM
				HYD-P	MTR-CODE: D 0824 LFL 02; OE-NO.: 06580732362; MOD: 8.163 LAEC; REQ: 2	AVX 13 x 1375 TM
	114-118 kW	D 0824 LFL 02;D 0824 LFL 06;D 0824 LFL 09		AC-C	MTR-CODE: D 0824 LFL 02; OE-NO.: 06580732312; MOD: 8.163 LAEC; REQ: 2	AVX 13 x 1250 TM
				ALT		AVX 10 x 1350 TM



# MAN

## L 2000

<b>8.163</b>						
4580 ccm	114-118 kW	D 0824 LFL 02;D 0824 LFL 06;D 0824 LFL 09	05.94 -	ALT	AMP: 35	AVX 10 x 1400
				HYD-P	MTR-CODE: D 0824 LFL 02; OE-NO.: 06580722342; MOD: 8.163 LAEC; REQ: 2	AVX 13 x 1325 TM
				HYD-P	MTR-CODE: D 0824 LFL 02; OE-NO.: 06580732292; MOD: 8.163 LAEC; REQ: 2	AVX 13 x 1200 TM
				HYD-P	MTR-CODE: D 0824 LFL 02; OE-NO.: 06580732362; MOD: 8.163 LAEC; REQ: 2	AVX 13 x 1375 TM
	114 kW	D 0824 LFL 09		AC-C	MTR-CODE: D 0824 LFL 02; OE-NO.: 06580722342; MOD: 8.163 LAEC; REQ: 2	AVX 13 x 1325 TM
				AC-C	MTR-CODE: D 0824 LFL 02; OE-NO.: 06580732312; MOD: 8.163 LAEC; REQ: 2	AVX 13 x 1250 TM
				ALT	MTR-CODE: D 0824 LFL 02; OE-NO.: 06580732292; MOD: 8.163 LAEC; REQ: 2	AVX 13 x 1200 TM
				ALT	MTR-CODE: D 0824 LFL 02; OE-NO.: 06580732362; MOD: 8.163 LAEC; REQ: 2	AVX 13 x 1375 TM
				HYD-P	MTR-CODE: D 0824 LFL 02; OE-NO.: 06580732362; MOD: 8.163 LAEC; REQ: 2	AVX 13 x 1375 TM

<b>8.185</b>						
4580 ccm	132 kW	D 0834 LFL 03	09.00 -	AC-C	MOD: 8.185 LAEC (LE180C); REQ: 2	AVX 13 x 1300 TM
				HYD-P	MOD: 8.185 LAEC (LE180C); REQ: 2	AVX 13 x 1375 TM
				ALT	OE-NO.: 51968200253; MOD: 8.185LAEC (LE180C)	12 PK 1300 TM

<b>8.223</b>						
6871 ccm	162-169 kW	D 0826 LFL02;D 0826 LFL06	10.93 - 06.96	AC-C	MTR-CODE: D 0826 LFL02; OE-NO.: 06580732312; MOD: 8.223 LAEC; REQ: 2	AVX 13 x 1250 TM
				ALT		AVX 10 x 1350 TM
				ALT		AVX 10 x 1375
				ALT	AMP: 35	AVX 10 x 1350 TM
				ALT	AMP: 35	AVX 10 x 1400
				HYD-P	MTR-CODE: D 0826 LFL02; OE-NO.: 06580722342; MOD: 8.223 LAEC; REQ: 2	AVX 13 x 1325 TM
				HYD-P	MTR-CODE: D 0826 LFL02; OE-NO.: 06580732292; MOD: 8.223 LAEC; REQ: 2	AVX 13 x 1200 TM
				HYD-P	MTR-CODE: D 0826 LFL02; OE-NO.: 06580732362; MOD: 8.223 LAEC; REQ: 2	AVX 13 x 1375 TM
	162 kW	D 0826 LFL06		AC-C	MTR-CODE: D 0826 LFL02; OE-NO.: 06580732312; MOD: 8.223 LAEC; REQ: 2	AVX 13 x 1250 TM
				ALT		AVX 10 x 1350 TM
				ALT	AMP: 35	AVX 10 x 1400
				HYD-P	MTR-CODE: D 0826 LFL02; OE-NO.: 06580722342; MOD: 8.223 LAEC; REQ: 2	AVX 13 x 1325 TM
				HYD-P	MTR-CODE: D 0826 LFL02; OE-NO.: 06580732292; MOD: 8.223 LAEC; REQ: 2	AVX 13 x 1200 TM
				HYD-P	MTR-CODE: D 0826 LFL02; OE-NO.: 06580732362; MOD: 8.223 LAEC; REQ: 2	AVX 13 x 1375 TM

<b>8.224</b>						
6871 ccm	162 kW	D 0826 LFL03	05.94 -	AC-C	OE-NO.: 06580732312; MOD: 8.224 LAEC; REQ: 2	AVX 13 x 1250 TM
				ALT		AVX 10 x 1350 TM
				ALT	AMP: 35	AVX 10 x 1350 TM
				ALT	AMP: 35	AVX 10 x 1400
				HYD-P	MTR-CODE: D 0826 LFL03; OE-NO.: 06580732362; MOD: 8.224 LAEC; REQ: 2	AVX 13 x 1375 TM
				HYD-P	OE-NO.: 06580722342; MOD: 8.224 LAEC; REQ: 2	AVX 13 x 1325 TM
				HYD-P	OE-NO.: 06580732292; MOD: 8.224 LAEC; REQ: 2	AVX 13 x 1200 TM

<b>8.225</b>						
6871 ccm	162 kW	D 0826 LFL10;D 0836 LFL 02	09.00 -	AC-C	MTR-CODE: D 0826 LFL03; OE-NO.: 06580722342; MOD: 8.224 LAEC; REQ: 2	AVX 13 x 1325 TM
				AC-C	MTR-CODE: D 0826 LFL03; OE-NO.: 06580732312; MOD: 8.224 LAEC; REQ: 2	AVX 13 x 1250 TM
				ALT	MTR-CODE: D 0826 LFL03; OE-NO.: 06580732292; MOD: 8.224 LAEC; REQ: 2	AVX 13 x 1200 TM
				ALT	MTR-CODE: D 0826 LFL03; OE-NO.: 06580732362; MOD: 8.224 LAEC; REQ: 2	AVX 13 x 1375 TM
				HYD-P	MTR-CODE: D 0826 LFL03; OE-NO.: 06580732362; MOD: 8.224 LAEC; REQ: 2	AVX 13 x 1375 TM
		D 0836 LFL 02		AC-C	MOD: 8.185 LAC; REQ: 2	AVX 13 x 1300 TM
				AC-C	MOD: 8.225 LAEK; REQ: 2	AVX 13 x 1300 TM
				HYD-P	MOD: 8.185 LAC; REQ: 2	AVX 13 x 1375 TM



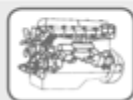

## MAN

### L 2000

#### 8.225

6871 ccm	162 kW	D 0836 LFL 02	09.00 -	HYD-P ALT	MOD: 8.225 LAEK; REQ: 2 OE-NO.: 51968200253; MOD: 8.185LAC	AVX 13 x 1375 TM 12 PK 1300 TM
----------	--------	---------------	---------	--------------	---	-----------------------------------

#### 9.145

4580 ccm	103 kW	D 0834 LFL 02	09.00 -	AC-C HYD-P ALT	MOD: 9.145 LK (LE140C); REQ: 2 MOD: 9.145 LK (LE140C); REQ: 2 OE-NO.: 51968200253; MOD: 9.145LK (LE140C)	AVX 13 x 1300 TM AVX 13 x 1375 TM 12 PK 1300 TM
----------	--------	---------------	---------	----------------------	--	---

#### 9.153

4580 ccm	114 kW	D 0824 LFL 01;D 0824 LFL 05	10.93 - 06.96	AC-C AC-C  ALT HYD-P  HYD-P  HYD-P	MTR-CODE: D 0824 LFL 01; OE-NO.: 06580732312; MOD: 9.153 LC;9.153 LLC; REQ: 2  MTR-CODE: D 0824 LFL 01; OE-NO.: 06580722342; MOD: 9.153 LC;9.153 LLC; REQ: 2  MTR-CODE: D 0824 LFL 01; OE-NO.: 06580732292; MOD: 9.153 LC;9.153 LLC; REQ: 2  MTR-CODE: D 0824 LFL 01; OE-NO.: 06580732362; MOD: 9.153 LC;9.153 LLC; REQ: 2	AVX 10 x 1250 AVX 13 x 1250 TM  AVX 10 x 1350 TM AVX 13 x 1325 TM  AVX 13 x 1200 TM  AVX 13 x 1375 TM
----------	--------	-----------------------------	---------------	--	--	---

#### 9.163

4580 ccm	104 kW	D 0824 LFL 07	05.94 -	AC-C ALT ALT ALT HYD-P  HYD-P HYD-P AC-C  ALT ALT ALT HYD-P  HYD-P  HYD-P	OE-NO.: 06580732312; MOD: 9.163 LC; REQ: 2  AMP: 35 AMP: 35 MTR-CODE: D 0824 LFL 07; OE-NO.: 06580732362; MOD: 9.163 LC; REQ: 2 OE-NO.: 06580722342; MOD: 9.163 LC; REQ: 2 OE-NO.: 06580732292; MOD: 9.163 LC; REQ: 2 MTR-CODE: D 0824 LFL 02; OE-NO.: 06580732312; MOD: 9.163 LC;9.163 LLC; REQ: 2  AMP: 35 AMP: 35 MTR-CODE: D 0824 LFL 02; OE-NO.: 06580722342; MOD: 9.163 LC;9.163 LLC; REQ: 2 MTR-CODE: D 0824 LFL 02; OE-NO.: 06580732292; MOD: 9.163 LC;9.163 LLC; REQ: 2 MTR-CODE: D 0824 LFL 02; OE-NO.: 06580732362; MOD: 9.163 LC;9.163 LLC; REQ: 2	AVX 13 x 1250 TM AVX 10 x 1350 TM AVX 10 x 1350 TM AVX 10 x 1400 AVX 13 x 1375 TM  AVX 13 x 1325 TM AVX 13 x 1200 TM AVX 13 x 1250 TM  AVX 10 x 1350 TM AVX 10 x 1350 TM AVX 10 x 1400 AVX 13 x 1325 TM  AVX 13 x 1200 TM  AVX 13 x 1375 TM
----------	--------	---------------	---------	--	--	--

#### 9.185

4580 ccm	132 kW	D 0834 LFL 03	09.00 -	AC-C HYD-P ALT	REQ: 2 REQ: 2 OE-NO.: 51968200253	AVX 13 x 1300 TM AVX 13 x 1375 TM 12 PK 1300 TM
----------	--------	---------------	---------	----------------------	---	---

#### 9.185; 180C)

4580 ccm	132 kW	D 0834 LFL 03	09.00 -	AC-C HYD-P ALT	REQ: 2 REQ: 2 OE-NO.: 51968200253	AVX 13 x 1300 TM AVX 13 x 1375 TM 12 PK 1300 TM
----------	--------	---------------	---------	----------------------	---	---

#### 9.223

6871 ccm	162-169 kW	D 0826 LFL02;D 0826 LFL06	10.93 - 06.96	AC-C  ALT ALT ALT HYD-P  HYD-P  HYD-P	MTR-CODE: D 0826 LFL02;D0826LFL06; OE- NO.: 06580732312; MOD: 9.223 LC;9.223 LLC; REQ: 2  AMP: 35 AMP: 35 MTR-CODE: D 0826 LFL02;D0826LFL06; OE- NO.: 06580722342; MOD: 9.223 LC;9.223 LLC; REQ: 2 MTR-CODE: D 0826 LFL02;D0826LFL06; OE- NO.: 06580732292; MOD: 9.223 LC;9.223 LLC; REQ: 2 MTR-CODE: D 0826 LFL02;D0826LFL06; OE- NO.: 06580732362; MOD: 9.223 LC;9.223 LLC; REQ: 2	AVX 13 x 1250 TM  AVX 10 x 1350 TM AVX 10 x 1350 TM AVX 10 x 1400 AVX 13 x 1325 TM  AVX 13 x 1200 TM  AVX 13 x 1375 TM
----------	------------	---------------------------	---------------	--	--	---



## MAN

### L 2000

<b>9.224</b>	6871 ccm	162 kW	D 0826 LFL03	05.94 -	AC-C	OE-NO.: 06580732312; MOD: 9.224 LC;9.224 LLC; REQ: 2	<b>AVX 13 x 1250 TM</b>
					ALT		<b>AVX 10 x 1350 TM</b>
					ALT	AMP: 35	<b>AVX 10 x 1350 TM</b>
					ALT	AMP: 35	<b>AVX 10 x 1400</b>
					HYD-P	MTR-CODE: D 0826 LFL03; OE-NO.: 06580732362; MOD: 9.224 LC;9.224 LLC; REQ: 2	<b>AVX 13 x 1375 TM</b>
					HYD-P	OE-NO.: 06580722342; MOD: 9.224 LC;9.224 LLC; REQ: 2	<b>AVX 13 x 1325 TM</b>
					HYD-P	OE-NO.: 06580732292; MOD: 9.224 LC;9.224 LLC; REQ: 2	<b>AVX 13 x 1200 TM</b>

### 9.225

6871 ccm	162 kW	D 0836 LFL 02	09.00 -	AC-C	MOD: 9.225 LLS (LE220C); REQ: 2	<b>AVX 13 x 1300 TM</b>
				HYD-P	MOD: 9.225 LLS (LE220C); REQ: 2	<b>AVX 13 x 1375 TM</b>

## LION S COACH

### 352; 353

11967 ccm	257 kW	D 2866 LOH 26	09.95 -	AC-C	MTR-CODE: D 2866 LOH 26; OE-NO.: 06580732272; AMP: 120; MOD: FRH 352;RH 353; REQ: 2; 1 ALT	<b>AVX 13 x 1150 TM</b>
				AC-C	MTR-CODE: D 2866 LOH 26; OE-NO.: 06580732272; AMP: 140; MOD: FRH 352;RH 353; REQ: 2; 1 ALT	<b>AVX 13 x 1150 TM</b>
				ALT	OE-NO.: 06580732292; AMP: 140; MOD: FRH 352;RH 353; REQ: 2; 1 ALT	<b>AVX 13 x 1200 TM</b>
				FAN	MOD: FRH 352;RH 353; REQ: 2	<b>AVX 13 x 1300 TM</b>
				FAN	MTR-CODE: D 2866 LOH 26; OE-NO.: 06580732262; AMP: 120; MOD: FRH 352;RH 353; REQ: 2; 1 ALT	<b>AVX 13 x 1125 TM</b>
				FAN	OE-NO.: 06580732282; AMP: 140; MOD: FRH 352;RH 353; REQ: 2; 1 ALT	<b>AVX 13 x 1175 TM</b>
				S-PUL	MTR-CODE: D 2866 LOH 26; OE-NO.: 06580732262; AMP: 140; MOD: FRH 352;RH 353; REQ: 2; 1 ALT	<b>AVX 13 x 1125 TM</b>
				W-P	OE-NO.: 06580732302; MOD: FRH 352;RH 353; REQ: 2	<b>AVX 13 x 1225 TM</b>

### 402; 403

11967 ccm	294 kW	D 2866 LOH 23	09.95 -	W-P	OE-NO.: 06580732302; MOD: FRH 402;RH 403; REQ: 2	<b>AVX 13 x 1225 TM</b>
				ALT	MOD: LION S Coach;FRH 402;RH 403; 2 ALT; OE-NO.: 06580490044	<b>8 PK 1495 TM</b>

## LION S COMFORT

### 313

11967 ccm	228 kW	D 2866 LUH 20;D 2866 LUH26	09.96 -	AC-C	MTR-CODE: D 2866 LUH 20; OE-NO.: 06580732272; AMP: 120; MOD: RN 313;RN 353; REQ: 2	<b>AVX 13 x 1150 TM</b>
				AC-C	MTR-CODE: D 2866 LUH 20; OE-NO.: 06580732272; AMP: 140; MOD: RN 313;RN 353; REQ: 2	<b>AVX 13 x 1150 TM</b>
				ALT	MTR-CODE: D 2866 LUH 20; OE-NO.: 06580732292; AMP: 140; MOD: RN 313;RN 353; REQ: 2	<b>AVX 13 x 1200 TM</b>
				FAN	MTR-CODE: D 2866 LUH 20; MOD: RN 313;RN 353; REQ: 2	<b>AVX 13 x 1300 TM</b>
				FAN	MTR-CODE: D 2866 LUH 20; OE-NO.: 06580732262; AMP: 120; MOD: RN 313;RN 353; REQ: 2	<b>AVX 13 x 1125 TM</b>
				FAN	MTR-CODE: D 2866 LUH 20; OE-NO.: 06580732282; AMP: 140; MOD: RN 313;RN 353; REQ: 2	<b>AVX 13 x 1175 TM</b>
				S-PUL	MTR-CODE: D 2866 LUH 20; OE-NO.: 06580732262; AMP: 140; MOD: RN 313;RN 353; REQ: 2	<b>AVX 13 x 1125 TM</b>
				W-P	MTR-CODE: D 2866 LUH 20; OE-NO.: 06580732302; MOD: RN 313;RN 353; REQ: 2	<b>AVX 13 x 1225 TM</b>

### 353

11967 ccm	257 kW	D 2866 LUH 21	06.97 -	AC-C	MTR-CODE: D 2866 LUH 20; OE-NO.: 06580732272; AMP: 120; MOD: RN 313;RN 353; REQ: 2	<b>AVX 13 x 1150 TM</b>
				AC-C	MTR-CODE: D 2866 LUH 20; OE-NO.: 06580732272; AMP: 140; MOD: RN 313;RN 353; REQ: 2	<b>AVX 13 x 1150 TM</b>

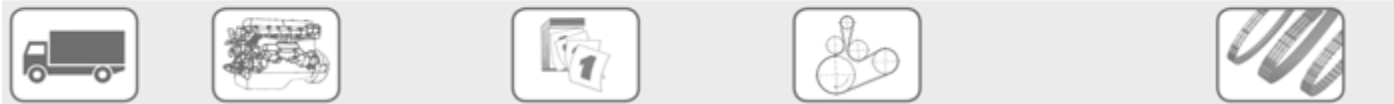

## MAN

### LION S COMFORT

#### 353

11967 ccm	257 kW	D 2866 LUH 21	06.97 -	ALT	MTR-CODE: D 2866 LUH 20; OE-NO.: 06580732292; AMP: 140; MOD: RN 313;RN 353; REQ: 2	AVX 13 x 1200 TM
				FAN	MTR-CODE: D 2866 LUH 20; MOD: RN 313;RN 353; REQ: 2	AVX 13 x 1300 TM
				FAN	MTR-CODE: D 2866 LUH 20; OE-NO.: 06580732262; AMP: 120; MOD: RN 313;RN 353; REQ: 2	AVX 13 x 1125 TM
				FAN	MTR-CODE: D 2866 LUH 20; OE-NO.: 06580732282; AMP: 140; MOD: RN 313;RN 353; REQ: 2	AVX 13 x 1175 TM
				S-PUL	MTR-CODE: D 2866 LUH 20; OE-NO.: 06580732262; AMP: 140; MOD: RN 313;RN 353; REQ: 2	AVX 13 x 1125 TM
				W-P	MTR-CODE: D 2866 LUH 20; OE-NO.: 06580732302; MOD: RN 313;RN 353; REQ: 2	AVX 13 x 1225 TM

### M 2000 L

#### 12.163

4580 ccm	114 kW	D 0824 LFL 06;D 0824 LFL 09	08.95 -	AC-C	MTR-CODE: D 0824 LFL 06; OE-NO.: 06580732312; REQ: 2	AVX 13 x 1250 TM
				AC-C	MTR-CODE: D 0824 LFL 06; OE-NO.: 06580732362; REQ: 2	AVX 13 x 1375 TM
				ALT		AVX 10 x 1400
				HYD-P	MTR-CODE: D 0824 LFL 06; OE-NO.: 06580722342; REQ: 2	AVX 13 x 1325 TM
				HYD-P	MTR-CODE: D 0824 LFL 06; OE-NO.: 06580732292; REQ: 2	AVX 13 x 1200 TM
				HYD-P	MTR-CODE: D 0824 LFL 06; OE-NO.: 06580732362; REQ: 2	AVX 13 x 1375 TM

#### 12.224

6871 ccm	162 kW	D 0826 LFL03;D 0826 LFL10	08.95 -	AC-C	MTR-CODE: D 0826 LFL03;D0826LFL03; OE-NO.: 06580732312; REQ: 2	AVX 13 x 1250 TM
				AC-C	MTR-CODE: D 0826 LFL03;D0826LFL03; OE-NO.: 06580732362; REQ: 2	AVX 13 x 1375 TM
				HYD-P	MTR-CODE: D 0826 LFL03;D0826LFL03; OE-NO.: 06580732292; REQ: 2	AVX 13 x 1200 TM
				HYD-P	MTR-CODE: D 0826 LFL03;D0826LFL03; OE-NO.: 06580732342; REQ: 2	AVX 13 x 1325 TM
				HYD-P	MTR-CODE: D 0826 LFL03;D0826LFL03; OE-NO.: 06580732362; REQ: 2	AVX 13 x 1375 TM

#### 12.224; 12.225

6871 ccm	162 kW	D 0826 LFL03;D 0826 LFL10	08.95 -	AC-C	MTR-CODE: D 0826 LFL03;D0826LFL03; OE-NO.: 06580732312; REQ: 2	AVX 13 x 1250 TM
				AC-C	MTR-CODE: D 0826 LFL03;D0826LFL03; OE-NO.: 06580732362; REQ: 2	AVX 13 x 1375 TM
				ALT	MTR-CODE: D0826LF03;D0826LF06;D0826LF07;D0826LF08; D0826LF09	AVX 10 x 1350 TM
				ALT	MTR-CODE: D0826LF03;D0826LF06;D0826LF07;D0826LF08; D0826LF09; AMP: 35	AVX 10 x 1400
				ALT	MTR-CODE: D0826LF15	AVX 10 x 1375
				HYD-P	MTR-CODE: D 0826 LFL03;D0826LFL03; OE-NO.: 06580732292; REQ: 2	AVX 13 x 1200 TM
				HYD-P	MTR-CODE: D 0826 LFL03;D0826LFL03; OE-NO.: 06580732342; REQ: 2	AVX 13 x 1325 TM
				HYD-P	MTR-CODE: D 0826 LFL03;D0826LFL03; OE-NO.: 06580732362; REQ: 2	AVX 13 x 1375 TM

#### 14.163

4580 ccm	114 kW	D 0824 LFL 06;D 0824 LFL 09	08.95 -	AC-C	MTR-CODE: D 0824 LFL 06; OE-NO.: 06580732312; REQ: 2	AVX 13 x 1250 TM
				AC-C	MTR-CODE: D 0824 LFL 06; OE-NO.: 06580732362; REQ: 2	AVX 13 x 1375 TM
				ALT		AVX 10 x 1400
				HYD-P	MTR-CODE: D 0824 LFL 06; OE-NO.: 06580722342; REQ: 2	AVX 13 x 1325 TM
				HYD-P	MTR-CODE: D 0824 LFL 06; OE-NO.: 06580732292; REQ: 2	AVX 13 x 1200 TM
				HYD-P	MTR-CODE: D 0824 LFL 06; OE-NO.: 06580732362; REQ: 2	AVX 13 x 1375 TM

#### 14.224

6871 ccm	162 kW	D 0826 LFL03;D 0826 LFL10	08.95 -	AC-C	MTR-CODE: D 0826 LFL03;D0826LFL03; OE-NO.: 06580732312; MOD: 14.224 LAC; REQ: 2	AVX 13 x 1250 TM
----------	--------	---------------------------	---------	------	---	------------------

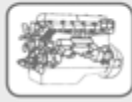

# MAN

## M 2000 L

<b>14.224</b>						
6871 ccm	162 kW	D 0826 LFL03;D 0826 LFL10	08.95 -	AC-C	MTR-CODE: D 0826 LFL03;D0826LFL03; OE-NO.: 06580732362; MOD: 14.224 LAC; REQ: 2	<b>AVX 13 x 1375 TM</b>
				ALT	MTR-CODE: D0826LF03;D0826LF06;D0826LF07;D0826LF08; D0826LF09	<b>AVX 10 x 1350 TM</b>
				ALT	MTR-CODE: D0826LF03;D0826LF06;D0826LF07;D0826LF08; D0826LF09; AMP: 35	<b>AVX 10 x 1400</b>
				ALT	MTR-CODE: D0826LF15	<b>AVX 10 x 1375</b>
				HYD-P	MTR-CODE: D 0826 LFL03;D0826LFL03; OE-NO.: 06580732292; MOD: 14.224 LAC; REQ: 2	<b>AVX 13 x 1200 TM</b>
				HYD-P	MTR-CODE: D 0826 LFL03;D0826LFL03; OE-NO.: 06580732342; MOD: 14.224 LAC; REQ: 2	<b>AVX 13 x 1325 TM</b>
				HYD-P	MTR-CODE: D 0826 LFL03;D0826LFL03; OE-NO.: 06580732362; MOD: 14.224 LAC; REQ: 2	<b>AVX 13 x 1375 TM</b>

<b>14.263; 14.264</b>						
6871 ccm	191 kW	D 0826 LFL09	08.95 -	AC-C	MTR-CODE: D 0826 LFL09; OE-NO.: 06580732362; MOD: 14.264 LAC; REQ: 2	<b>AVX 13 x 1375 TM</b>
				AC-C	OE-NO.: 06580732312; MOD: 14.264 LAC; REQ: 2	<b>AVX 13 x 1250 TM</b>
				HYD-P	MTR-CODE: D 0826 LFL09; OE-NO.: 06580732362; MOD: 14.264 LAC; REQ: 2	<b>AVX 13 x 1375 TM</b>
				HYD-P	OE-NO.: 06580722342; MOD: 14.264 LAC; REQ: 2	<b>AVX 13 x 1325 TM</b>
				HYD-P	OE-NO.: 06580732292; MOD: 14.264 LAC; REQ: 2	<b>AVX 13 x 1200 TM</b>

<b>14.285</b>						
6871 ccm	206 kW	D 0836 LFL 03	09.00 -	AC-C	MOD: 14.255 LK (LE250B); REQ: 2	<b>AVX 13 x 1300 TM</b>
				HYD-P	MOD: 14.255 LK (LE250B); REQ: 2	<b>AVX 13 x 1375 TM</b>

<b>15.163</b>						
4580 ccm	114 kW	D 0824 LFL 06;D 0824 LFL 09	08.95 -	AC-C	MTR-CODE: D 0824 LFL 06; OE-NO.: 06580732312; REQ: 2	<b>AVX 13 x 1250 TM</b>
				AC-C	MTR-CODE: D 0824 LFL 06; OE-NO.: 06580732362; REQ: 2	<b>AVX 13 x 1375 TM</b>
				ALT		<b>AVX 10 x 1400</b>
				HYD-P	MTR-CODE: D 0824 LFL 06; OE-NO.: 06580722342; REQ: 2	<b>AVX 13 x 1325 TM</b>
				HYD-P	MTR-CODE: D 0824 LFL 06; OE-NO.: 06580732292; REQ: 2	<b>AVX 13 x 1200 TM</b>
				HYD-P	MTR-CODE: D 0824 LFL 06; OE-NO.: 06580732362; REQ: 2	<b>AVX 13 x 1375 TM</b>

<b>15.224</b>						
6871 ccm	162 kW	D 0826 LFL03;D 0826 LFL10	08.95 -	AC-C	MTR-CODE: D 0826 LFL03;D0826LFL03; OE-NO.: 06580732312; REQ: 2	<b>AVX 13 x 1250 TM</b>
				AC-C	MTR-CODE: D 0826 LFL03;D0826LFL03; OE-NO.: 06580732362; REQ: 2	<b>AVX 13 x 1375 TM</b>
				ALT	MTR-CODE: D0826LF03;D0826LF06;D0826LF07;D0826LF08; D0826LF09	<b>AVX 10 x 1350 TM</b>
				ALT	MTR-CODE: D0826LF03;D0826LF06;D0826LF07;D0826LF08; D0826LF09; AMP: 35	<b>AVX 10 x 1400</b>
				ALT	MTR-CODE: D0826LF15	<b>AVX 10 x 1375</b>
				HYD-P	MTR-CODE: D 0826 LFL03;D0826LFL03; OE-NO.: 06580732292; REQ: 2	<b>AVX 13 x 1200 TM</b>
				HYD-P	MTR-CODE: D 0826 LFL03;D0826LFL03; OE-NO.: 06580732342; REQ: 2	<b>AVX 13 x 1325 TM</b>
				HYD-P	MTR-CODE: D 0826 LFL03;D0826LFL03; OE-NO.: 06580732362; REQ: 2	<b>AVX 13 x 1375 TM</b>

<b>15.225</b>						
6871 ccm	162 kW	D 0836 LFL 02	09.99 -	AC-C	REQ: 2	<b>AVX 13 x 1300 TM</b>
				HYD-P	REQ: 2	<b>AVX 13 x 1375 TM</b>

<b>15.263; 15.264</b>						
6871 ccm	191 kW	D 0826 LFL09	08.95 -	AC-C	MTR-CODE: D 0826 LFL09; OE-NO.: 06580732362; REQ: 2	<b>AVX 13 x 1375 TM</b>
				AC-C	OE-NO.: 06580732312; REQ: 2	<b>AVX 13 x 1250 TM</b>
				HYD-P	MTR-CODE: D 0826 LFL09; OE-NO.: 06580732362; REQ: 2	<b>AVX 13 x 1375 TM</b>
				HYD-P	OE-NO.: 06580722342; REQ: 2	<b>AVX 13 x 1325 TM</b>
				HYD-P	OE-NO.: 06580732292; REQ: 2	<b>AVX 13 x 1200 TM</b>

<b>15.285</b>						
6871 ccm	206 kW	D 0836 LFL 03	09.99 -	AC-C	REQ: 2	<b>AVX 13 x 1300 TM</b>



## MAN

### M 2000 L

#### 15.285

6871 ccm 206 kW D 0836 LFL 03 09.99 - HYD-P REQ: 2 AVX 13 x 1375 TM

#### 18.224; 18.225

6871 ccm 162 kW D 0826 LFL03;D 0826 LFL10 08.95 - AC-C MTR-CODE: D 0826 LFL03;D0826LFL03; OE-NO.: 06580732312; MOD: 18.224 LAC; REQ: 2 AVX 13 x 1250 TM

AC-C MTR-CODE: D 0826 LFL03;D0826LFL03; OE-NO.: 06580732362; MOD: 18.224 LAC; REQ: 2 AVX 13 x 1375 TM

ALT MTR-CODE: D0826LF03;D0826LF06;D0826LF07;D0826LF08;D0826LF09 AVX 10 x 1350 TM

ALT MTR-CODE: D0826LF03;D0826LF06;D0826LF07;D0826LF08;D0826LF09; AMP: 35 AVX 10 x 1400

ALT MTR-CODE: D0826LF15 AVX 10 x 1375

HYD-P MTR-CODE: D 0826 LFL03;D0826LFL03; OE-NO.: 06580732292; MOD: 18.224 LAC; REQ: 2 AVX 13 x 1200 TM

HYD-P MTR-CODE: D 0826 LFL03;D0826LFL03; OE-NO.: 06580732342; MOD: 18.224 LAC; REQ: 2 AVX 13 x 1325 TM

HYD-P MTR-CODE: D 0826 LFL03;D0826LFL03; OE-NO.: 06580732362; MOD: 18.224 LAC; REQ: 2 AVX 13 x 1375 TM

D 0826 LFL03;D 0826 LFL10;D 0836 LFL 02 AC-C MTR-CODE: D 0826 LFL03;D0826LFL03; OE-NO.: 06580732312; MOD: 18.224 LAC; REQ: 2 AVX 13 x 1250 TM

AC-C MTR-CODE: D 0826 LFL03;D0826LFL03; OE-NO.: 06580732362; MOD: 18.224 LAC; REQ: 2 AVX 13 x 1375 TM

ALT MTR-CODE: D0826LF03;D0826LF06;D0826LF07;D0826LF08;D0826LF09 AVX 10 x 1350 TM

ALT MTR-CODE: D0826LF03;D0826LF06;D0826LF07;D0826LF08;D0826LF09; AMP: 35 AVX 10 x 1400

ALT MTR-CODE: D0826LF15 AVX 10 x 1375

HYD-P MTR-CODE: D 0826 LFL03;D0826LFL03; OE-NO.: 06580732292; MOD: 18.224 LAC; REQ: 2 AVX 13 x 1200 TM

HYD-P MTR-CODE: D 0826 LFL03;D0826LFL03; OE-NO.: 06580732342; MOD: 18.224 LAC; REQ: 2 AVX 13 x 1325 TM

HYD-P MTR-CODE: D 0826 LFL03;D0826LFL03; OE-NO.: 06580732362; MOD: 18.224 LAC; REQ: 2 AVX 13 x 1375 TM

#### 18.263; 18.264

6871 ccm 191 kW D 0826 LFL09 08.95 - AC-C MTR-CODE: D 0826 LFL09; OE-NO.: 06580732362; MOD: 18.264 LAC; REQ: 2 AVX 13 x 1375 TM

AC-C OE-NO.: 06580732312; MOD: 18.264 LAC; REQ: 2 AVX 13 x 1250 TM

HYD-P MTR-CODE: D 0826 LFL09; OE-NO.: 06580732362; MOD: 18.264 LAC; REQ: 2 AVX 13 x 1375 TM

HYD-P OE-NO.: 06580722342; MOD: 18.264 LAC; REQ: 2 AVX 13 x 1325 TM

HYD-P OE-NO.: 06580732292; MOD: 18.264 LAC; REQ: 2 AVX 13 x 1200 TM

#### 18.285

6871 ccm 206 kW D 0836 LFL 03 09.99 - AC-C MOD: 18.285 LAC (LE280B); REQ: 2 AVX 13 x 1300 TM

HYD-P MOD: 18.285 LAC (LE280B); REQ: 2 AVX 13 x 1375 TM

### M 2000 M

#### 14.224

6871 ccm 162 kW D 0826 LF10;D 0826 LF15;D 0826 LF18 08.95 - AC-C MTR-CODE: D 0826 LF15;D0826LF15; MOD: 14.224 MAK; REQ: 2 AVX 13 x 1300 TM

AC-C MTR-CODE: D 0826 LF15;D0826LF15; MOD: 14.224 MAK; REQ: 2 AVX 13 x 1375 TM

ALT MTR-CODE: D0826LF03;D0826LF06;D0826LF07;D0826LF08;D0826LF09 AVX 10 x 1350 TM

ALT MTR-CODE: D0826LF03;D0826LF06;D0826LF07;D0826LF08;D0826LF09; AMP: 35 AVX 10 x 1400

ALT MTR-CODE: D0826LF15 AVX 10 x 1375

D 0826 LF15;D 0826 LF18 AC-C MTR-CODE: D 0826 LF15;D0826LF15; MOD: 14.224 MAK; REQ: 2 AVX 13 x 1300 TM

AC-C MTR-CODE: D 0826 LF15;D0826LF15; MOD: 14.224 MAK; REQ: 2 AVX 13 x 1375 TM

ALT MTR-CODE: D0826LF03;D0826LF06;D0826LF07;D0826LF08;D0826LF09 AVX 10 x 1350 TM

ALT MTR-CODE: D0826LF03;D0826LF06;D0826LF07;D0826LF08;D0826LF09; AMP: 35 AVX 10 x 1400

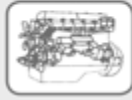

## MAN

### M 2000 M

<b>14.224</b>						
6871 ccm	162 kW	D 0826 LF15;D 0826 LF18	08.95 -	ALT	MTR-CODE: D0826LF15	AVX 10 x 1375
<b>14.264</b>						
6871 ccm	191 kW	D 0826 LF17	08.95 -	AC-C	REQ: 2	AVX 13 x 1375 TM
				ALT		AVX 10 x 1375
				HYD-P	REQ: 2	AVX 13 x 1300 TM
<b>18.224</b>						
6871 ccm	162 kW	D 0826 LF15;D 0826 LF18	08.95 -	AC-C	MTR-CODE: D 0826 LF15;D0826LF15; MOD: 18.224 MAC; REQ: 2	AVX 13 x 1375 TM
				ALT	MTR-CODE: D0826LF03;D0826LF06;D0826LF07;D0826LF08; D0826LF09	AVX 10 x 1350 TM
				ALT	MTR-CODE: D0826LF03;D0826LF06;D0826LF07;D0826LF08; D0826LF09; AMP: 35	AVX 10 x 1400
				ALT	MTR-CODE: D0826LF15	AVX 10 x 1375
				HYD-P	MTR-CODE: D 0826 LF15;D0826LF15; MOD: 18.224 MAC; REQ: 2	AVX 13 x 1300 TM
<b>18.264</b>						
6871 ccm	191 kW	D 0826 LF17	08.95 -	AC-C	MOD: 18.264 MAC; REQ: 2	AVX 13 x 1375 TM
				ALT		AVX 10 x 1375
				HYD-P	MOD: 18.264 MAC; REQ: 2	AVX 13 x 1300 TM
<b>25.224</b>						
6871 ccm	162 kW	D 0826 LF15;D 0826 LF18;D 0826 LFL10	08.95 - 12.05	AC-C	MTR-CODE: D 0826 LF15;D0826LF15; REQ: 2	AVX 13 x 1300 TM
				ALT	MTR-CODE: D0826LF03;D0826LF06;D0826LF07;D0826LF08; D0826LF09	AVX 10 x 1350 TM
				ALT	MTR-CODE: D0826LF03;D0826LF06;D0826LF07;D0826LF08; D0826LF09; AMP: 35	AVX 10 x 1400
				ALT	MTR-CODE: D0826LF15	AVX 10 x 1375
				HYD-P	MTR-CODE: D 0826 LF15;D0826LF15; REQ: 2	AVX 13 x 1375 TM
<b>25.264</b>						
6871 ccm	191 kW	D 0826 LF17	08.95 - 12.05	AC-C	REQ: 2	AVX 13 x 1375 TM
				HYD-P	REQ: 2	AVX 13 x 1300 TM

### M 90

<b>12.152</b>						
6871 ccm	110-114 kW	D 0826 F01;D 0826 F02	12.88 - 05.94	AC-C	MTR-CODE: D 0826 F01; MOD: 12.152 F;12.152 FL; REQ: 2	AVX 13 x 1250 TM
				ALT	MTR-CODE: D0826F01;D0826F02 2 Riemen;D0826FR01; REQ: 2	AVX 10 x 1300
				ALT	MTR-CODE: D0826F01;D0826F02;D0826FR01; REQ: 2	AVX 10 x 1300
<b>12.192</b>						
6871 ccm	140 kW	D 0826 LF01;D 0826 LF05;D 0826 LF07	07.90 - 06.96	AC-C	MTR-CODE: D 0826 LF01; MOD: 12.192 F;12.192 FL; REQ: 2; - MTR-CODE: D0826LF01	AVX 13 x 1250 TM
				AC-C	MTR-CODE: D 0826 LF01;D0826LF01; MOD: 12.192 F;12.192 FL; REQ: 2	AVX 13 x 1300 TM
				HYD-P	MTR-CODE: D 0826 LF01; MOD: 12.192 F;12.192 FL; REQ: 2; - ADD-HYD-P / RAD-C	AVX 13 x 1250 TM
				HYD-P	MTR-CODE: D 0826 LF01; MOD: 12.192 F;12.192 FL; REQ: 2; + ADD-HYD-P / RAD-C	AVX 13 x 1225 TM
				HYD-P	MTR-CODE: D 0826 LF01;D0826LF01; MOD: 12.192 F;12.192 FL; REQ: 2	AVX 13 x 1250 TM
		D 0826 LF05;D 0826 LF07		AC-C	MTR-CODE: D 0826 LF01; MOD: 12.192 F;12.192 FL; REQ: 2; - MTR-CODE: D0826LF01	AVX 13 x 1250 TM
				AC-C	MTR-CODE: D 0826 LF01;D0826LF01; MOD: 12.192 F;12.192 FL; REQ: 2	AVX 13 x 1300 TM
				HYD-P	MTR-CODE: D 0826 LF01; MOD: 12.192 F;12.192 FL; REQ: 2; - ADD-HYD-P / RAD-C	AVX 13 x 1250 TM
				HYD-P	MTR-CODE: D 0826 LF01; MOD: 12.192 F;12.192 FL; REQ: 2; + ADD-HYD-P / RAD-C	AVX 13 x 1225 TM
				HYD-P	MTR-CODE: D 0826 LF01;D0826LF01; MOD: 12.192 F;12.192 FL; REQ: 2	AVX 13 x 1250 TM
<b>12.232</b>						
6871 ccm	169 kW	D 0826 LF02;D 0826 LF06;D 0826 LF08	08.88 - 06.96	AC-C	MTR-CODE: D 0826 LF02; MOD: 12.232 FS;12.232 FLS; REQ: 2	AVX 13 x 1250 TM
				AC-C	MTR-CODE: D 0826 LF02; MOD: 12.232 FS;12.232 FLS; REQ: 2	AVX 13 x 1300 TM
				HYD-P	MTR-CODE: D 0826 LF02; MOD: 12.232 FS;12.232 FLS; REQ: 2; - ADD-HYD-P / RAD-C	AVX 13 x 1250 TM



## MAN

### M 90

#### 12.232

6871 ccm 169 kW D 0826 LF02;D 0826 LF06;D 0826 LF08 08.88 - 06.96 HYD-P MTR-CODE: D 0826 LF02; MOD: 12.232 FS;12.232 FLS; REQ: 2; + ADD-HYD-P / RAD-C **AVX 13 x 1225 TM**

#### 12.262

6871 ccm 191 kW D 0826 LF13 08.95 - 06.96 AC-C MOD: 12.262 F;12.262 FL; REQ: 2 **AVX 13 x 1300 TM**  
AC-C MTR-CODE: D 0826 LF13; MOD: 12.262 F;12.262 FL; REQ: 2 **AVX 13 x 1250 TM**  
ALT **AVX 10 x 1400**  
HYD-P MOD: 12.262 F;12.262 FL; REQ: 2; + ADD-HYD-P / RAD-C **AVX 13 x 1225 TM**  
HYD-P MTR-CODE: D 0826 LF13; MOD: 12.262 F;12.262 FL; REQ: 2; - ADD-HYD-P / RAD-C **AVX 13 x 1250 TM**

#### 12.272

6871 ccm 198 kW D 0826 LF04 09.91 - 06.96 AC-C MOD: 12.272 F;12.272 FL; REQ: 2 **AVX 13 x 1300 TM**  
AC-C MTR-CODE: D 0826 LF04; MOD: 12.272 F;12.272 FL; REQ: 2 **AVX 13 x 1250 TM**  
HYD-P MOD: 12.272 F;12.272 FL; REQ: 2; + ADD-HYD-P / RAD-C **AVX 13 x 1225 TM**  
HYD-P MTR-CODE: D 0826 LF04; MOD: 12.272 F;12.272 FL; REQ: 2; - ADD-HYD-P / RAD-C **AVX 13 x 1250 TM**  
9973 ccm D 2865 LF02 AC-C MOD: 12.272 F;12.272 FL **AVX 13 x 1450 TM**  
ALT MOD: 12.272 F;12.272 FL; REQ: 2 **AVX 13 x 1475 TM**  
HYD-P MOD: 12.272 F;12.272 FL; REQ: 2 **AVX 13 x 1425 TM**  
W-P MOD: 12.272 F;12.272 FL; REQ: 2 **AVX 13 x 1225 TM**

#### 14.152

6871 ccm 110-114 kW D 0826 F01;D 0826 F02 12.88 - 06.96 AC-C MTR-CODE: D 0826 F01; MOD: 14.152 F;14.152 FL; REQ: 2 **AVX 13 x 1250 TM**  
ALT MTR-CODE: D0826F01;D0826F02 2 Riemen;D0826FR01 **AVX 10 x 1300**  
ALT MTR-CODE: D0826F01;D0826F02 2 Riemen;D0826FR01; REQ: 2 **AVX 10 x 1300**  
ALT MTR-CODE: D0826F01;D0826F02;D0826FR01; REQ: 2 **AVX 10 x 1300**  
4580 ccm 114 kW D 0824 LF 01 ALT MTR-CODE: D0826F01;D0826F02 2 Riemen;D0826FR01; REQ: 2 **AVX 10 x 1300**  
ALT MTR-CODE: D0826F01;D0826F02 2 Riemen;D0826FR01; REQ: 2 **AVX 10 x 1300**  
ALT MTR-CODE: D0826F01;D0826F02;D0826FR01; REQ: 2 **AVX 10 x 1300**

#### 14.192

6596 ccm 137 kW D 0826 TF 08.88 - 06.96 AC-C MTR-CODE: D 0826 TF; MOD: 14.192 F;14.192 FL; REQ: 2 **AVX 13 x 1250 TM**  
HYD-P MTR-CODE: D 0826 TF; MOD: 14.192 F;14.192 FL; REQ: 2 **AVX 13 x 1225 TM**  
HYD-P MTR-CODE: D 0826 TF; MOD: 14.192 F;14.192 FL; REQ: 2; - ADD-HYD-P / RAD-C **AVX 13 x 1250 TM**  
HYD-P MTR-CODE: D 0826 TF; MOD: 14.192 F;14.192 FL; REQ: 2; + ADD-HYD-P / RAD-C **AVX 13 x 1225 TM**  
6871 ccm 140 kW D 0826 LF01;D 0826 LF05;D 0826 LF07 AC-C MTR-CODE: D 0826 LF01; MOD: 14.192 F;14.192 FL; REQ: 2; - MTR-CODE: D0826LF01 **AVX 13 x 1250 TM**  
AC-C MTR-CODE: D 0826 LF01; MOD: 14.192 FS;14.192 FLS; REQ: 2; - MTR-CODE: D0826LF01 **AVX 13 x 1250 TM**  
AC-C MTR-CODE: D 0826 LF01;D0826LF01; MOD: 14.192 F;14.192 FL; REQ: 2 **AVX 13 x 1300 TM**  
AC-C MTR-CODE: D 0826 LF01;D0826LF01; MOD: 14.192 FS;14.192 FLS; REQ: 2 **AVX 13 x 1300 TM**  
HYD-P MTR-CODE: D 0826 LF01; MOD: 14.192 F;14.192 FL; REQ: 2; - ADD-HYD-P / RAD-C **AVX 13 x 1250 TM**  
HYD-P MTR-CODE: D 0826 LF01; MOD: 14.192 F;14.192 FL; REQ: 2; + ADD-HYD-P / RAD-C **AVX 13 x 1225 TM**  
HYD-P MTR-CODE: D 0826 LF01; MOD: 14.192 FS;14.192 FLS; REQ: 2; - ADD-HYD-P / RAD-C **AVX 13 x 1250 TM**  
HYD-P MTR-CODE: D 0826 LF01; MOD: 14.192 FS;14.192 FLS; REQ: 2; + ADD-HYD-P / RAD-C **AVX 13 x 1225 TM**  
HYD-P MTR-CODE: D 0826 LF01;D0826LF01; MOD: 14.192 F;14.192 FL; REQ: 2 **AVX 13 x 1250 TM**  
HYD-P MTR-CODE: D 0826 LF01;D0826LF01; MOD: 14.192 FS;14.192 FLS; REQ: 2 **AVX 13 x 1250 TM**

#### 14.232

6870 ccm 160 kW D 0826 LF/217/Silent 08.88 - 06.96 AC-C MTR-CODE: D 0826 LF;217;Silent; MOD: 14.232 F;14.232 FL **AVX 13 x 1250 TM**

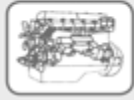

# MAN

## M 90

14.232						
6870 ccm	160 kW	D 0826 LF/217/Silent	08.88 - 06.96	AC-C	MTR-CODE: D 0826 LF;217;Silent; MOD: 14.232 F;14.232 FL	AVX 13 x 1300 TM
				HYD-P	MTR-CODE: D 0826 LF;217;Silent; MOD: 14.232 F;14.232 FL; REQ: 2; - ADD-HYD-P / RAD-C	AVX 13 x 1250 TM
				HYD-P	MTR-CODE: D 0826 LF;217;Silent; MOD: 14.232 F;14.232 FL; REQ: 2; + ADD-HYD-P / RAD-C	AVX 13 x 1225 TM
6871 ccm	169 kW	D 0826 LF02;D 0826 LF06;D 0826 LF08		AC-C	MTR-CODE: D 0826 LF02; MOD: 14.232 FS;14.232 FLS; REQ: 2	AVX 13 x 1250 TM
				AC-C	MTR-CODE: D 0826 LF02; MOD: 14.232 FS;14.232 FLS; REQ: 2	AVX 13 x 1300 TM
				HYD-P	MTR-CODE: D 0826 LF02; MOD: 14.232 FS;14.232 FLS; REQ: 2; - ADD-HYD-P / RAD-C	AVX 13 x 1250 TM
				HYD-P	MTR-CODE: D 0826 LF02; MOD: 14.232 FS;14.232 FLS; REQ: 2; + ADD-HYD-P / RAD-C	AVX 13 x 1225 TM
14.262						
6871 ccm	191 kW	D 0826 LF13	08.95 - 06.96	AC-C	MOD: 14.262 F;14.262 FL; REQ: 2	AVX 13 x 1300 TM
				AC-C	MTR-CODE: D 0826 LF13; MOD: 14.262 F;14.262 FL; REQ: 2	AVX 13 x 1250 TM
				ALT		AVX 10 x 1400
				HYD-P	MOD: 14.262 F;14.262 FL; REQ: 2; + ADD-HYD-P / RAD-C	AVX 13 x 1225 TM
				HYD-P	MTR-CODE: D 0826 LF13; MOD: 14.262 F;14.262 FL; REQ: 2; - ADD-HYD-P / RAD-C	AVX 13 x 1250 TM
14.272						
6871 ccm	198 kW	D 0826 LF04	09.91 - 06.96	AC-C	MOD: 14.272 F;14.272 FL; REQ: 2	AVX 13 x 1300 TM
				AC-C	MTR-CODE: D 0826 LF04; MOD: 14.272 F;14.272 FL; REQ: 2	AVX 13 x 1250 TM
				HYD-P	MOD: 14.272 F;14.272 FL; REQ: 2; + ADD-HYD-P / RAD-C	AVX 13 x 1225 TM
				HYD-P	MTR-CODE: D 0826 LF04; MOD: 14.272 F;14.272 FL; REQ: 2; - ADD-HYD-P / RAD-C	AVX 13 x 1250 TM
9973 ccm		D 2865 LF02		AC-C	MOD: 14.272 F;14.272 FL	AVX 13 x 1450 TM
				ALT	MOD: 14.272 F;14.272 FL; REQ: 2	AVX 13 x 1475 TM
				HYD-P	MOD: 14.272 F;14.272 FL; REQ: 2	AVX 13 x 1425 TM
				W-P	MOD: 14.272 F;14.272 FL; REQ: 2	AVX 13 x 1225 TM
17.192						
6596 ccm	137 kW	D 0826 TF	08.88 - 06.96	AC-C	MTR-CODE: D 0826 TF; MOD: 17.192 F;17.192 FL; REQ: 2	AVX 13 x 1250 TM
				HYD-P	MTR-CODE: D 0826 TF; MOD: 17.192 F;17.192 FL; REQ: 2	AVX 13 x 1225 TM
				HYD-P	MTR-CODE: D 0826 TF; MOD: 17.192 F;17.192 FL; REQ: 2; - ADD-HYD-P / RAD-C	AVX 13 x 1250 TM
				HYD-P	MTR-CODE: D 0826 TF; MOD: 17.192 F;17.192 FL; REQ: 2; + ADD-HYD-P / RAD-C	AVX 13 x 1225 TM
6871 ccm	140 kW	D 0826 LF01		AC-C	MOD: 17.192 FK; REQ: 2	AVX 13 x 1300 TM
				AC-C	MTR-CODE: D 0826 LF01; MOD: 17.192 FK; REQ: 2	AVX 13 x 1250 TM
				HYD-P	MOD: 17.192 FK; REQ: 2; + ADD-HYD-P / RAD-C	AVX 13 x 1225 TM
				HYD-P	MTR-CODE: D 0826 LF01; MOD: 17.192 FK; REQ: 2; - ADD-HYD-P / RAD-C	AVX 13 x 1250 TM
		D 0826 LF01;D 0826 LF05		AC-C	MTR-CODE: D 0826 LF01; MOD: 17.192 F;17.192 FL; REQ: 2; - MTR-CODE: D0826LF01	AVX 13 x 1250 TM
				AC-C	MTR-CODE: D 0826 LF01;D0826LF01; MOD: 17.192 F;17.192 FL; REQ: 2	AVX 13 x 1300 TM
				HYD-P	MTR-CODE: D 0826 LF01; MOD: 17.192 F;17.192 FL; REQ: 2; - ADD-HYD-P / RAD-C	AVX 13 x 1250 TM
				HYD-P	MTR-CODE: D 0826 LF01; MOD: 17.192 F;17.192 FL; REQ: 2; + ADD-HYD-P / RAD-C	AVX 13 x 1225 TM
				HYD-P	MTR-CODE: D 0826 LF01;D0826LF01; MOD: 17.192 F;17.192 FL; REQ: 2	AVX 13 x 1250 TM
		D 0826 LF01;D 0826 LF05;D 0826 LF07		AC-C	MTR-CODE: D 0826 LF01; MOD: 17.192 F;17.192 FL; REQ: 2; - MTR-CODE: D0826LF01	AVX 13 x 1250 TM
				AC-C	MTR-CODE: D 0826 LF01;D0826LF01; MOD: 17.192 F;17.192 FL; REQ: 2	AVX 13 x 1300 TM
				HYD-P	MTR-CODE: D 0826 LF01; MOD: 17.192 F;17.192 FL; REQ: 2; - ADD-HYD-P / RAD-C	AVX 13 x 1250 TM
				HYD-P	MTR-CODE: D 0826 LF01; MOD: 17.192 F;17.192 FL; REQ: 2; + ADD-HYD-P / RAD-C	AVX 13 x 1225 TM
				HYD-P	MTR-CODE: D 0826 LF01;D0826LF01; MOD: 17.192 F;17.192 FL; REQ: 2	AVX 13 x 1250 TM



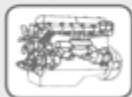

## MAN

### M 90

#### 17.232

6870 ccm	160 kW	D 0826 LF/217/Silent	08.88 - 06.96	AC-C	MTR-CODE: D 0826 LF;217;Silent; MOD: 17.232 F;17.232 FL	AVX 13 x 1250 TM
				AC-C	MTR-CODE: D 0826 LF;217;Silent; MOD: 17.232 F;17.232 FL	AVX 13 x 1300 TM
				HYD-P	MTR-CODE: D 0826 LF;217;Silent; MOD: 17.232 F;17.232 FL; REQ: 2; - ADD-HYD-P / RAD-C	AVX 13 x 1250 TM
				HYD-P	MTR-CODE: D 0826 LF;217;Silent; MOD: 17.232 F;17.232 FL; REQ: 2; + ADD-HYD-P / RAD-C	AVX 13 x 1225 TM
6871 ccm	169 kW	D 0826 LF02		AC-C	MOD: 17.232 F;17.232 FL	AVX 13 x 1300 TM
				AC-C	MTR-CODE: D 0826 LF02; MOD: 17.232 F;17.232 FL	AVX 13 x 1250 TM
				HYD-P	MOD: 17.232 F;17.232 FL; REQ: 2; + ADD-HYD-P / RAD-C	AVX 13 x 1225 TM
				HYD-P	MTR-CODE: D 0826 LF02; MOD: 17.232 F;17.232 FL; REQ: 2; - ADD-HYD-P / RAD-C	AVX 13 x 1250 TM
		D 0826 LF02;D 0826 LF06		AC-C	MTR-CODE: D 0826 LF02; MOD: 17.232 F;17.232 FL	AVX 13 x 1250 TM
				AC-C	MTR-CODE: D 0826 LF02; MOD: 17.232 F;17.232 FL	AVX 13 x 1300 TM
				HYD-P	MTR-CODE: D 0826 LF02; MOD: 17.232 F;17.232 FL; REQ: 2; - ADD-HYD-P / RAD-C	AVX 13 x 1250 TM
				HYD-P	MTR-CODE: D 0826 LF02; MOD: 17.232 F;17.232 FL; REQ: 2; + ADD-HYD-P / RAD-C	AVX 13 x 1225 TM
		D 0826 LF02;D 0826 LF06;D 0826 LF08		AC-C	MTR-CODE: D 0826 LF02; MOD: 17.232 F;17.232 FL	AVX 13 x 1250 TM
				AC-C	MTR-CODE: D 0826 LF02; MOD: 17.232 F;17.232 FL	AVX 13 x 1300 TM
				HYD-P	MTR-CODE: D 0826 LF02; MOD: 17.232 F;17.232 FL; REQ: 2; - ADD-HYD-P / RAD-C	AVX 13 x 1250 TM
				HYD-P	MTR-CODE: D 0826 LF02; MOD: 17.232 F;17.232 FL; REQ: 2; + ADD-HYD-P / RAD-C	AVX 13 x 1225 TM

#### 17.272

6871 ccm	198 kW	D 0826 LF04	09.91 - 05.95	AC-C	MOD: 17.272 FLS; REQ: 2	AVX 13 x 1300 TM
				AC-C	MTR-CODE: D 0826 LF04; MOD: 17.272 FLS; REQ: 2	AVX 13 x 1250 TM
				HYD-P	MOD: 17.272 FLS; REQ: 2; + ADD-HYD-P / RAD-C	AVX 13 x 1225 TM
				HYD-P	MTR-CODE: D 0826 LF04; MOD: 17.272 FLS; REQ: 2; - ADD-HYD-P / RAD-C	AVX 13 x 1250 TM

#### 18.192

6871 ccm	140 kW	D 0826 LF01;D 0826 LF05;D 0826 LF07	09.90 - 06.96	AC-C	MTR-CODE: D 0826 LF01; REQ: 2; - MTR-CODE: D0826LF01	AVX 13 x 1250 TM
				AC-C	MTR-CODE: D 0826 LF01;D0826LF01; REQ: 2	AVX 13 x 1250 TM
				AC-C	MTR-CODE: D 0826 LF01;D0826LF01; REQ: 2	AVX 13 x 1300 TM
				HYD-P	MTR-CODE: D 0826 LF01; REQ: 2; - ADD-HYD-P / RAD-C	AVX 13 x 1250 TM
				HYD-P	MTR-CODE: D 0826 LF01; REQ: 2; + ADD-HYD-P / RAD-C	AVX 13 x 1225 TM

#### 18.232

6871 ccm	169 kW	D 0826 LF02;D 0826 LF06;D 0826 LF08	09.90 - 06.96	AC-C	MTR-CODE: D 0826 LF02; REQ: 2	AVX 13 x 1250 TM
				AC-C	MTR-CODE: D 0826 LF02; REQ: 2	AVX 13 x 1300 TM
				HYD-P	MTR-CODE: D 0826 LF02; REQ: 2; - ADD-HYD-P / RAD-C	AVX 13 x 1250 TM
				HYD-P	MTR-CODE: D 0826 LF02; REQ: 2; + ADD-HYD-P / RAD-C	AVX 13 x 1225 TM

#### 18.262

6871 ccm	191 kW	D 0826 LF13	08.95 - 06.96	AC-C	MTR-CODE: D 0826 LF13; REQ: 2	AVX 13 x 1250 TM
				AC-C	REQ: 2	AVX 13 x 1300 TM
				HYD-P	MTR-CODE: D 0826 LF13; REQ: 2; - ADD-HYD-P / RAD-C	AVX 13 x 1250 TM
				HYD-P	REQ: 2; + ADD-HYD-P / RAD-C	AVX 13 x 1225 TM

#### 18.272

6871 ccm	198 kW	D 0826 LF04	09.91 - 06.96	AC-C	MTR-CODE: D 0826 LF04; REQ: 2	AVX 13 x 1250 TM
				AC-C	REQ: 2	AVX 13 x 1300 TM
				HYD-P	MTR-CODE: D 0826 LF04; REQ: 2; - ADD-HYD-P / RAD-C	AVX 13 x 1250 TM
				HYD-P	REQ: 2; + ADD-HYD-P / RAD-C	AVX 13 x 1225 TM
9973 ccm		D 2865 LF02		AC-C		AVX 13 x 1450 TM
				ALT	REQ: 2	AVX 13 x 1475 TM
				HYD-P	REQ: 2	AVX 13 x 1425 TM

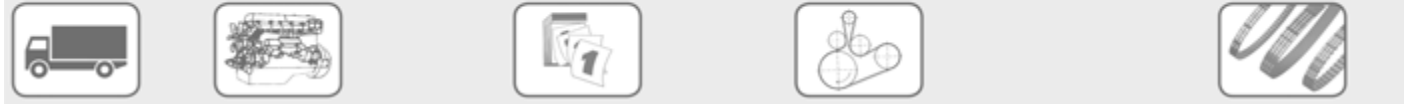
**MAN**
**M 90**

<b>18.272</b>						
9973 ccm	198 kW	D 2865 LF02	09.91 - 06.96	W-P	REQ: 2	AVX 13 x 1225 TM
<b>24.192</b>						
6871 ccm	140 kW	D 0826 LF01;D 0826 LF05;D 0826 LF07	07.89 - 06.96	AC-C	MTR-CODE: D 0826 LF01; MOD: 12.192 F;12.192 FL; REQ: 2; - MTR-CODE: D0826LF01	AVX 13 x 1250 TM
				AC-C	MTR-CODE: D 0826 LF01; MOD: 14.192 F;14.192 FL; REQ: 2; - MTR-CODE: D0826LF01	AVX 13 x 1250 TM
				AC-C	MTR-CODE: D 0826 LF01; REQ: 2; - MTR-CODE: D0826LF01	AVX 13 x 1250 TM
				AC-C	MTR-CODE: D 0826 LF01;D0826LF01; MOD: 12.192 F;12.192 FL; REQ: 2	AVX 13 x 1250 TM
				AC-C	MTR-CODE: D 0826 LF01;D0826LF01; MOD: 12.192 F;12.192 FL; REQ: 2	AVX 13 x 1300 TM
				AC-C	MTR-CODE: D 0826 LF01;D0826LF01; MOD: 14.192 F;14.192 FL; REQ: 2	AVX 13 x 1250 TM
				AC-C	MTR-CODE: D 0826 LF01;D0826LF01; MOD: 14.192 F;14.192 FL; REQ: 2	AVX 13 x 1300 TM
				AC-C	MTR-CODE: D 0826 LF01;D0826LF01; REQ: 2	AVX 13 x 1250 TM
				AC-C	MTR-CODE: D 0826 LF01;D0826LF01; REQ: 2	AVX 13 x 1300 TM
				HYD-P	MTR-CODE: D 0826 LF01; MOD: 12.192 F;12.192 FL; REQ: 2; - ADD-HYD-P / RAD-C	AVX 13 x 1250 TM
				HYD-P	MTR-CODE: D 0826 LF01; MOD: 12.192 F;12.192 FL; REQ: 2; + ADD-HYD-P / RAD-C	AVX 13 x 1225 TM
				HYD-P	MTR-CODE: D 0826 LF01; MOD: 14.192 F;14.192 FL; REQ: 2; - ADD-HYD-P / RAD-C	AVX 13 x 1250 TM
				HYD-P	MTR-CODE: D 0826 LF01; MOD: 14.192 F;14.192 FL; REQ: 2; + ADD-HYD-P / RAD-C	AVX 13 x 1225 TM
				HYD-P	MTR-CODE: D 0826 LF01; REQ: 2; - ADD-HYD-P / RAD-C	AVX 13 x 1250 TM
				HYD-P	MTR-CODE: D 0826 LF01; REQ: 2; + ADD-HYD-P / RAD-C	AVX 13 x 1225 TM
<b>24.232</b>						
6871 ccm	169 kW	D 0826 LF02;D 0826 LF06;D 0826 LF08	07.89 - 06.96	AC-C	MTR-CODE: D 0826 LF02; REQ: 2	AVX 13 x 1250 TM
				AC-C	MTR-CODE: D 0826 LF02; REQ: 2	AVX 13 x 1300 TM
				HYD-P	MTR-CODE: D 0826 LF02; REQ: 2; - ADD-HYD-P / RAD-C	AVX 13 x 1250 TM
				HYD-P	MTR-CODE: D 0826 LF02; REQ: 2; + ADD-HYD-P / RAD-C	AVX 13 x 1225 TM
<b>24.272</b>						
6871 ccm	198 kW	D 0826 LF04	09.91 - 06.96	AC-C	MTR-CODE: D 0826 LF04; REQ: 2	AVX 13 x 1250 TM
				AC-C	REQ: 2	AVX 13 x 1300 TM
				HYD-P	MTR-CODE: D 0826 LF04; REQ: 2; - ADD-HYD-P / RAD-C	AVX 13 x 1250 TM
				HYD-P	REQ: 2; + ADD-HYD-P / RAD-C	AVX 13 x 1225 TM
9973 ccm		D 2865 LF02		AC-C		AVX 13 x 1450 TM
				ALT	UNTIL: 06.93	AVX 13 x 1475 TM
				HYD-P	REQ: 2	AVX 13 x 1425 TM
				W-P	REQ: 2	AVX 13 x 1225 TM

**NG**

<b>262</b>						
9973 ccm	191 kW	D 2865 LUH09	06.97 - 07.98	ALT	MTR-CODE: D 2865 LUH07; OE-NO.: 06580722262; AMP: 120; MOD: NG 262;NG 312; REQ: 2	AVX 13 x 1125 TM
				ALT	MTR-CODE: D 2865 LUH07; OE-NO.: 06580732282; AMP: 140; MOD: NG 262;NG 312; REQ: 2	AVX 13 x 1175 TM
				FAN	MTR-CODE: D 2865 LUH07; MOD: NG 262;NG 312; REQ: 2	AVX 13 x 1300 TM
				W-P	MTR-CODE: D 2865 LUH07; MOD: NG 262;NG 312; REQ: 2	AVX 13 x 1225 TM
				W-P	MTR-CODE: D 2865 LUH07; OE-NO.: 06580732302; AMP: 140; MOD: NG 262;NG 312; REQ: 2	AVX 13 x 1225 TM
<b>262; 263</b>						
11967 ccm	191 kW	D 2866 LUH 22	07.98 -	ALT	MTR-CODE: D 2866 LUH 22; OE-NO.: 06580732262; AMP: 120; MOD: NG 262;NG 263; REQ: 2	AVX 13 x 1125 TM
				ALT	OE-NO.: 06580732272; AMP: 140; MOD: NG 262;NG 263; REQ: 2	AVX 13 x 1150 TM
				ALT	OE-NO.: 06580732282; AMP: 140; MOD: NG 262;NG 263; REQ: 2	AVX 13 x 1175 TM

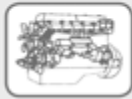

## MAN

### NG

#### 262; 263

11967 ccm	191 kW	D 2866 LUH 22	07.98 -	HYD-P S-PUL	MOD: NG 262;NG 263; REQ: 2 MTR-CODE: D 2866 LUH 22; OE-NO.: 06580732262; AMP: 140; MOD: NG 262;NG 263; REQ: 2	AVX 13 x 1300 TM AVX 13 x 1125 TM
				W-P	OE-NO.: 06580732302; MOD: NG 262;NG 263; REQ: 2 IN CON. WITH: Generator 28,5V 120A	AVX 13 x 1225 TM 8 PK 1158 TM

#### 262; 272

6871 ccm	191-198 kW	D 0826 LUH 01	08.92 - 07.98	AC-C	OE-NO.: 06580590206; MOD: NG 262;NG 272; REQ: 2	XPB 1500
				FAN	OE-NO.: 06580732332; MOD: NG 262;NG 272; REQ: 2	AVX 13 x 1300 TM
				HYD-P HYD-P	MOD: NG 262;NG 272; + AC OE-NO.: 06580732523; MOD: NG 262;NG 272; REQ: 2	AVX 13 x 1350 TM AVX 13 x 1775 TM

#### 312

9973 ccm	228 kW	D 2865 LUH07	09.95 - 07.98	ALT	OE-NO.: 06580722262; AMP: 120; MOD: NG 262;NG 312; REQ: 2	AVX 13 x 1125 TM
				ALT	OE-NO.: 06580732282; AMP: 140; MOD: NG 262;NG 312; REQ: 2	AVX 13 x 1175 TM
				FAN	MOD: NG 262;NG 312; REQ: 2	AVX 13 x 1300 TM
				W-P	MTR-CODE: D 2865 LUH07; MOD: NG 262;NG 312; REQ: 2	AVX 13 x 1225 TM
				W-P	MTR-CODE: D 2865 LUH07; OE-NO.: 06580732302; AMP: 140; MOD: NG 262;NG 312; REQ: 2	AVX 13 x 1225 TM

#### 312; 313

11967 ccm	228 kW	D 2866 LUH26	07.98 -		IN CON. WITH: Generator 28,5V 120A	8 PK 1158 TM
-----------	--------	--------------	---------	--	------------------------------------	--------------

#### 313

10518 ccm	228 kW	D 2066 LUH 12;D 2066 LUH 22	08.92 -		IN CON. WITH: Generator 28,5V 120A	8 PK 1158 TM
12816 ccm		E 2876 LUH 02			IN CON. WITH: Generator 28,5V 120A	8 PK 1158 TM

#### 323

10518 ccm	235 kW	D 2066 LUH 42	08.92 -		IN CON. WITH: Generator 28,5V 120A	8 PK 1158 TM
-----------	--------	---------------	---------	--	------------------------------------	--------------

#### 353

10518 ccm	257 kW	D 2066 LUH 13;D 2066 LUH 23	08.92 -		IN CON. WITH: Generator 28,5V 120A	8 PK 1158 TM
-----------	--------	-----------------------------	---------	--	------------------------------------	--------------

#### 363

10518 ccm	264 kW	D 2066 LUH 48	08.92 -		IN CON. WITH: Generator 28,5V 120A	8 PK 1158 TM
-----------	--------	---------------	---------	--	------------------------------------	--------------

### NL

#### 202

6871 ccm	157 kW	D 0826 LUH/213	09.89 - 04.94	AC-C	OE-NO.: 06580490026; MOD: NL202	6 PK 1515 TM
				AC-C	OE-NO.: 88968200001; MOD: NL202	6 PK 2200
				ALT	OE-NO.: 51968200231; MOD: NL202; + AIR-C	12 PK 1865 TM
				ALT	OE-NO.: 51968200242; MOD: NL202	10 PK 1860 TM

#### 202; 222; 223

6871 ccm	157-162 kW	D 0826 LUH 03;D 0826 LUH 12	08.92 -		IN CON. WITH: Generator 28,5V 120A	8 PK 1158 TM
				AC-C	MTR-CODE: D0826LUH; OE-NO.: 06580490026; MOD: NL202	6 PK 1515 TM
				AC-C	MTR-CODE: D0826LUH; OE-NO.: 88968200001; MOD: NL202	6 PK 2200
				ALT	MTR-CODE: D0826LUH; OE-NO.: 51968200231; MOD: NL202; + AIR-C	12 PK 1865 TM
				ALT	MTR-CODE: D0826LUH; OE-NO.: 51968200242; MOD: NL202	10 PK 1860 TM

#### 202; 262; 263

6871 ccm	184 kW	D 0826 LUH	04.91 -		IN CON. WITH: Generator 28,5V 120A	8 PK 1158 TM
				AC-C	OE-NO.: 06580490026; MOD: NL202	6 PK 1515 TM
				AC-C	OE-NO.: 88968200001; MOD: NL202	6 PK 2200
				ALT	OE-NO.: 51968200231; MOD: NL202; + AIR-C	12 PK 1865 TM
				ALT	OE-NO.: 51968200242; MOD: NL202	10 PK 1860 TM

#### 243

11967 ccm	180 kW	E 2866 DUH 03;E 2866 DUH 04	09.88 -		IN CON. WITH: Generator 28,5V 120A	8 PK 1158 TM
-----------	--------	-----------------------------	---------	--	------------------------------------	--------------

#### 262

9973 ccm	191 kW	D 2865 LUH09	06.97 -	ALT	MTR-CODE: D 2865 LUH07; OE-NO.: 06580722262; MOD: NL 262;NL 312; REQ: 2	AVX 13 x 1125 TM
				ALT	MTR-CODE: D 2865 LUH07; OE-NO.: 06580732282; MOD: NL 262;NL 312; REQ: 2	AVX 13 x 1175 TM
				W-P	MTR-CODE: D 2865 LUH07; MOD: NL 262;NL 312; REQ: 2	AVX 13 x 1225 TM

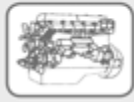

# MAN

## NL

<b>262</b>	9973 ccm	191 kW	D 2865 LUH09	06.97 -	W-P	MTR-CODE: D 2865 LUH07; OE-NO.: 06580732302; MOD: NL 262;NL 312; REQ: 2	<b>AVX 13 x 1225 TM</b>
------------	----------	--------	--------------	---------	-----	---	-------------------------

<b>262; 263</b>	11967 ccm	191 kW	D 2866 LUH 22	07.98 -	ALT	OE-NO.: 06580732262; MOD: NL 262;NL 263;NL 313; REQ: 2	<b>AVX 13 x 1125 TM</b>
					ALT	OE-NO.: 06580732272; MOD: NL 262;NL 263;NL 313; REQ: 2	<b>AVX 13 x 1150 TM</b>
					ALT	OE-NO.: 06580732282; MOD: NL 262;NL 263;NL 313; REQ: 2	<b>AVX 13 x 1175 TM</b>
					ALT	OE-NO.: 06580732292; MOD: NL 262;NL 263;NL 313; REQ: 2	<b>AVX 13 x 1200 TM</b>
					W-P	MOD: NL 262;NL 263;NL 313; REQ: 2 IN CON. WITH: Generator 28,5V 120A	<b>AVX 13 x 1225 TM</b> <b>8 PK 1158 TM</b>

<b>273</b>	10518 ccm	199 kW	D 2066 LUH 11;D 2066 LUH 21	09.88 -		IN CON. WITH: Generator 28,5V 120A	<b>8 PK 1158 TM</b>
------------	-----------	--------	-----------------------------	---------	--	------------------------------------	---------------------

<b>283</b>	10518 ccm	206 kW	D 2066 LUH 41	09.88 -		IN CON. WITH: Generator 28,5V 120A	<b>8 PK 1158 TM</b>
------------	-----------	--------	---------------	---------	--	------------------------------------	---------------------

<b>312</b>	9973 ccm	228 kW	D 2865 LUH07	11.95 - 07.98	ALT	OE-NO.: 06580722262; MOD: NL 262;NL 312; REQ: 2	<b>AVX 13 x 1125 TM</b>
					ALT	OE-NO.: 06580732282; MOD: NL 262;NL 312; REQ: 2	<b>AVX 13 x 1175 TM</b>
					W-P	MTR-CODE: D 2865 LUH07; MOD: NL 262;NL 312; REQ: 2	<b>AVX 13 x 1225 TM</b>
					W-P	MTR-CODE: D 2865 LUH07; OE-NO.: 06580732302; MOD: NL 262;NL 312; REQ: 2	<b>AVX 13 x 1225 TM</b>

<b>313</b>	10518 ccm	228 kW	D 2066 LUH 12;D 2066 LUH 22	09.88 -		IN CON. WITH: Generator 28,5V 120A	<b>8 PK 1158 TM</b>
	11967 ccm		D 2866 LUH26		ALT	MTR-CODE: D 2866 LUH 22; OE-NO.: 06580732262; MOD: NL 262;NL 263;NL 313; REQ: 2	<b>AVX 13 x 1125 TM</b>
					ALT	MTR-CODE: D 2866 LUH 22; OE-NO.: 06580732272; MOD: NL 262;NL 263;NL 313; REQ: 2	<b>AVX 13 x 1150 TM</b>
					ALT	MTR-CODE: D 2866 LUH 22; OE-NO.: 06580732282; MOD: NL 262;NL 263;NL 313; REQ: 2	<b>AVX 13 x 1175 TM</b>
					ALT	MTR-CODE: D 2866 LUH 22; OE-NO.: 06580732292; MOD: NL 262;NL 263;NL 313; REQ: 2	<b>AVX 13 x 1200 TM</b>
					W-P	MTR-CODE: D 2866 LUH 22; MOD: NL 262;NL 263;NL 313; REQ: 2 IN CON. WITH: Generator 28,5V 120A	<b>AVX 13 x 1225 TM</b> <b>8 PK 1158 TM</b>
	12816 ccm		E 2876 LUH 02			IN CON. WITH: Generator 28,5V 120A	<b>8 PK 1158 TM</b>

<b>323</b>	10518 ccm	235 kW	D 2066 LUH 42	09.88 -		IN CON. WITH: Generator 28,5V 120A	<b>8 PK 1158 TM</b>
------------	-----------	--------	---------------	---------	--	------------------------------------	---------------------

## NÜ

<b>263</b>	6871 ccm	191 kW	D 0826 LUH 13	09.96 -		IN CON. WITH: Generator 28,5V 120A	<b>8 PK 1158 TM</b>
					AC-C	MOD: NÜ263	<b>6 PK 1515 TM</b>
					ALT	OE-NO.: 51968200231; MOD: NÜ263; + AIR-C	<b>12 PK 1865 TM</b>
					ALT	OE-NO.: 51968200242; MOD: NÜ263	<b>10 PK 1860 TM</b>
	9973 ccm		D 2865 LUH09		ALT	OE-NO.: 06580722262; MOD: NÜ 263; REQ: 2	<b>AVX 13 x 1125 TM</b>
					ALT	OE-NO.: 06580732282; MOD: NÜ 263; REQ: 2	<b>AVX 13 x 1175 TM</b>
					W-P	MTR-CODE: D 2865 LUH09; MOD: NÜ 263; REQ: 2	<b>AVX 13 x 1225 TM</b>
					W-P	MTR-CODE: D 2865 LUH09; OE-NO.: 06580732302; MOD: NÜ 263; REQ: 2 IN CON. WITH: Generator 28,5V 120A	<b>AVX 13 x 1225 TM</b> <b>8 PK 1158 TM</b>

<b>313</b>	11967 ccm	228 kW	D 2866 LUH26	07.98 -	ALT	OE-NO.: 06580732262; MOD: NÜ 313;NÜ 313 15M; REQ: 2	<b>AVX 13 x 1125 TM</b>
					ALT	OE-NO.: 06580732272; MOD: NÜ 313;NÜ 313 15M; REQ: 2	<b>AVX 13 x 1150 TM</b>
					ALT	OE-NO.: 06580732282; MOD: NÜ 313;NÜ 313 15M; REQ: 2	<b>AVX 13 x 1175 TM</b>
					ALT	OE-NO.: 06580732292; MOD: NÜ 313;NÜ 313 15M; REQ: 2	<b>AVX 13 x 1200 TM</b>
					W-P	MOD: NÜ 313;NÜ 313 15M; REQ: 2 IN CON. WITH: Genrator 28,5V 120A	<b>AVX 13 x 1225 TM</b> <b>8 PK 1158 TM</b>

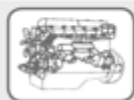

## MAN

### NÜ

#### 313.15M

11967 ccm	228 kW	D 2866 LUH26	07.98 -	ALT	OE-NO.: 06580732262; MOD: NÜ 313;NÜ 313 15M; REQ: 2	AVX 13 x 1125 TM
				ALT	OE-NO.: 06580732272; MOD: NÜ 313;NÜ 313 15M; REQ: 2	AVX 13 x 1150 TM
				ALT	OE-NO.: 06580732282; MOD: NÜ 313;NÜ 313 15M; REQ: 2	AVX 13 x 1175 TM
				ALT	OE-NO.: 06580732292; MOD: NÜ 313;NÜ 313 15M; REQ: 2	AVX 13 x 1200 TM
				W-P	MOD: NÜ 313;NÜ 313 15M; REQ: 2 IN CON. WITH: Generator 28,5V 120A	AVX 13 x 1225 TM 8 PK 1158 TM

#### 353.15M

11967 ccm	257 kW	D 2866 LUH 21	07.98 -	ALT	OE-NO.: 06580732262; MOD: NÜ 353 15M; REQ: 2	AVX 13 x 1125 TM
				ALT	OE-NO.: 06580732272; MOD: NÜ 353 15M; REQ: 2	AVX 13 x 1150 TM
				ALT	OE-NO.: 06580732282; MOD: NÜ 353 15M; REQ: 2	AVX 13 x 1175 TM
				ALT	OE-NO.: 06580732292; MOD: NÜ 353 15M; REQ: 2	AVX 13 x 1200 TM
				W-P	OE-NO.: 06580732302; MOD: NÜ 353 15M; REQ: 2	AVX 13 x 1225 TM

### SG

#### 240; 242

11967 ccm	177-180 kW	D 2866 UH/240	09.85 - 04.94	ALT	MTR-CODE: D 2866 UH;240; OE-NO.: 06580722262; REQ: 2	AVX 13 x 1125 TM
				ALT	MTR-CODE: D 2866 UH;240; OE-NO.: 06580732272; REQ: 2	AVX 13 x 1150 TM
				W-P	MTR-CODE: D 2866 UH;240; OE-NO.: 06580722312; REQ: 2	AVX 13 x 1250 TM

#### 242; 292

11967 ccm	224-229 kW	D 2866 TOH/310;D 2866 TUH/290	09.85 - 04.94	ALT	MTR-CODE: D 2866 TOH;310; OE-NO.: 06580722262; MOD: SG 242;SG 292; REQ: 2	AVX 13 x 1125 TM
				ALT	MTR-CODE: D 2866 TOH;310; OE-NO.: 06580732272; MOD: SG 242;SG 292; REQ: 2	AVX 13 x 1150 TM
				W-P	MTR-CODE: D 2866 TOH;310; MOD: SG 242;SG 292; REQ: 2	AVX 13 x 1250 TM
				W-P	MTR-CODE: D 2866 TOH;310; OE-NO.: 06580722312; MOD: SG 242;SG 292; REQ: 2	AVX 13 x 1250 TM

#### 312; 322

9973 ccm	228-235 kW	D 2865 LUH07;D 2865 LUH08	02.94 - 06.97	ALT	MTR-CODE: D 2865 LUH07; OE-NO.: 06580732282; MOD: SG 312;SG 322; REQ: 2	AVX 13 x 1175 TM
				FAN	MTR-CODE: D 2865 LUH07; MOD: SG 312;SG 322; REQ: 2	AVX 13 x 1300 TM
				W-P	MTR-CODE: D 2865 LUH07; MOD: SG 312;SG 322; REQ: 2	AVX 13 x 1225 TM
				W-P	MTR-CODE: D 2865 LUH07; OE-NO.: 06580732302; MOD: SG 312;SG 322; REQ: 2	AVX 13 x 1225 TM

### SL II

#### 202

11413 ccm	147-155 kW	D 2566 UH	06.84 - 04.94	ALT	OE-NO.: 06580722262; MOD: SL 202; REQ: 2	AVX 13 x 1125 TM
				ALT	OE-NO.: 06580732272; MOD: SL 202; REQ: 2	AVX 13 x 1150 TM
				W-P	MOD: SL 202; REQ: 2	AVX 13 x 1250 TM
11967 ccm	177-180 kW	D 2866 UH/240		ALT	MTR-CODE: D 2866 UH;240; OE-NO.: 06580722262; MOD: SL 202; REQ: 2	AVX 13 x 1125 TM
				ALT	MTR-CODE: D 2866 UH;240; OE-NO.: 06580732272; MOD: SL 202; REQ: 2	AVX 13 x 1150 TM
				W-P	MTR-CODE: D 2866 UH;240; MOD: SL 202; REQ: 2	AVX 13 x 1250 TM

#### 283

6871 ccm	206 kW	D 0836 LOH 55	04.84 - 05.96		IN CON. WITH: Generator 28,5V	8 PK 1158 TM
----------	--------	---------------	---------------	--	-------------------------------	--------------

#### 353

10518 ccm	257 kW	D 2066 LOH 12;D 2066 LOH 13	04.84 - 05.96		IN CON. WITH: Generator 28,5V 120A	8 PK 1158 TM
-----------	--------	-----------------------------	---------------	--	------------------------------------	--------------

#### 363

10518 ccm	264 kW	D 2066 LOH 27	04.84 - 05.96		IN CON. WITH: Generator 28,5V 120A	8 PK 1158 TM
-----------	--------	---------------	---------------	--	------------------------------------	--------------

### SÜ

#### 240

11413 ccm	147-150 kW	D 2566 MUH/200;D 2566 UH/205	10.75 - 09.89	ALT	MTR-CODE: D 2566 MUH;200; OE-NO.: 06580722262; MOD: SÜ 240; REQ: 2	AVX 13 x 1125 TM
-----------	------------	------------------------------	---------------	-----	--	------------------

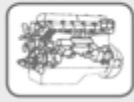

## MAN

### SÜ

240							
11413 ccm	147-150 kW	D 2566 MUH/200;D 2566 UH/205	10.75 - 09.89	W-P	MTR-CODE: D 2566 MUH;200; OE-NO.: 06580722302; MOD: SÜ 240; REQ: 2		AVX 13 x 1225 TM
				W-P	MTR-CODE: D 2566 MUH;200; OE-NO.: 06580722312; MOD: SÜ 240; REQ: 2		AVX 13 x 1250 TM
	177 kW	D 2566 MUH/240		ALT	MTR-CODE: D 2566 MUH;200; OE-NO.: 06580722262; MOD: SÜ 240; REQ: 2		AVX 13 x 1125 TM
				W-P	MTR-CODE: D 2566 MUH;200; OE-NO.: 06580722302; MOD: SÜ 240; REQ: 2		AVX 13 x 1225 TM
				W-P	MTR-CODE: D 2566 MUH;200; OE-NO.: 06580722312; MOD: SÜ 240; REQ: 2		AVX 13 x 1250 TM
	206 kW	D 2566 MTUH		ALT	MTR-CODE: D 2566 MTUH;280; OE-NO.: 06580722262; MOD: SÜ 240; REQ: 2		AVX 13 x 1125 TM
				ALT	MTR-CODE: D 2566 MTUH;280; OE-NO.: 06580732282; MOD: SÜ 240; REQ: 2		AVX 13 x 1175 TM
				W-P	MTR-CODE: D 2566 MTUH;280; OE-NO.: 06580722302; MOD: SÜ 240; REQ: 2		AVX 13 x 1225 TM
				W-P	MTR-CODE: D 2566 MTUH;280; OE-NO.: 06580722312; MOD: SÜ 240; REQ: 2		AVX 13 x 1250 TM

263							
6871 ccm	191 kW	D 0836 LOH 62	10.75 -		IN CON. WITH: Generator 28,5V 120A		8 PK 1158 TM

272							
9973 ccm	198 kW	D 2865 LUH02	04.93 - 05.95	ALT	OE-NO.: 06580732262; MOD: SÜ 272;SÜ 322; REQ: 2		AVX 13 x 1125 TM
				ALT	OE-NO.: 06580732282; MOD: SÜ 272;SÜ 322; REQ: 2		AVX 13 x 1175 TM
				W-P	MOD: SÜ 272;SÜ 322; REQ: 2		AVX 13 x 1225 TM

273							
10518 ccm	198 kW	D 2066 LUH 11;D 2066 LUH 21	10.75 -		IN CON. WITH: Generator 28,5V 120A		8 PK 1158 TM

283							
6871 ccm	206 kW	D 0836 LOH 02;D 0836 LOH 51;D 0836 LOH 55	09.03 -		IN CON. WITH: Generator 28,5V 120A		8 PK 1158 TM

293							
6871 ccm	213 kW	D 0836 LOH 60	09.03 -		IN CON. WITH: Generator 28,5V 120A		8 PK 1158 TM

313							
10518 ccm	228 kW	D 2066 LUH 12;D 2066 LUH 22	10.75 -		IN CON. WITH: Generator 28,5V 120A		8 PK 1158 TM

320							
10518 ccm	235 kW	D 2066 LUH 32	09.03 -		IN CON. WITH: Generator 28,5V 120A		8 PK 1158 TM

322							
9973 ccm	235 kW	D 2865 LUH08	05.95 - 06.97	ALT	MTR-CODE: D 2865 LUH02; OE-NO.: 06580732262; MOD: SÜ 272;SÜ 322; REQ: 2		AVX 13 x 1125 TM
				ALT	MTR-CODE: D 2865 LUH02; OE-NO.: 06580732282; MOD: SÜ 272;SÜ 322; REQ: 2		AVX 13 x 1175 TM
				W-P	MTR-CODE: D 2865 LUH02; MOD: SÜ 272;SÜ 322; REQ: 2		AVX 13 x 1225 TM

353							
10518 ccm	257 kW	D 2066 LUH 13;D 2066 LUH 23	10.75 -		IN CON. WITH: Generator 28,5V 120A		8 PK 1158 TM

360							
10518 ccm	264 kW	D 2066 LUH 33	10.75 -		IN CON. WITH: Generator 28,5V 120A		8 PK 1158 TM

### TGA

18.310							
11967 ccm	228 kW	D 2866 LF26	04.00 -	FAN	MOD: 18.310 FAC; REQ: 2		AVX 13 x 1275 TM
				AC-C	MOD: 18.310FAC		8 PK 1376 TM
		D 2866 LF26;D 2866 LF36		FAN	MTR-CODE: D 2866 LF26; MOD: 18.310 FAC; REQ: 2		AVX 13 x 1275 TM
				AC-C	MTR-CODE: D2866LF26; MOD: 18.310FAC		8 PK 1376 TM
				ALT			KT 7006
				ALT; AC-C			KT 7005

18.310; 18.320							
10518 ccm	228-235 kW	D 2066 LF 04;D 2066 LF 14;D 2066 LF 28;D 2066 LF 35;D 2066 LF 39	05.04 -	ALT	MTR-CODE: D2066LF01; MOD: 18.310FAC; - AC		8 PK 1635 TM
				ALT	MTR-CODE: D2066LF01; MOD: 18.310FAC; + AC		8 PK 1920 TM
		D 2066 LF 04;D 2066 LF 14;D 2066 LF 35;D 2066 LF 39		ALT	MTR-CODE: D2066LF01; MOD: 18.310FAC; - AC		8 PK 1635 TM
				ALT	MTR-CODE: D2066LF01; MOD: 18.310FAC; + AC		8 PK 1920 TM

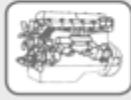

## MAN

### TGA

#### 18.310; 18320

11967 ccm	228-235 kW	D 2866 LF26;D 2866 LF36	04.00 -	AC-C	MTR-CODE: D 2866 LF26; OE-NO.: 06580732352; MOD: 26.310 FD-TM; REQ: 2	AVX 13 x 1350 TM
				FAN	MTR-CODE: D 2866 LF26; MOD: 18.310 FAC; REQ: 2	AVX 13 x 1275 TM
				AC-C	MTR-CODE: D2866LF26; MOD: 18.310FAC	8 PK 1376 TM
				AC-C	MTR-CODE: D2866LF26; OE-NO.: 51968200238; MOD: 26.310FD-TM	8 PK 880 TM
				AC-C	MTR-CODE: D2866LF26; OE-NO.: 51968200239; MOD: 26.310FD-TM	8 PK 1376 TM
				ALT	MTR-CODE: D2866LF26; MOD: 26.310FD-TM	14 PK 1305 TM
				ALT	MTR-CODE: D2866LF26; MOD: 26.310FD-TM	5 PK 1482 TM
				HYD-P	MTR-CODE: D2866LF26; MOD: 26.310FD-TM	8 PK 1515 TM
				ALT		KT 7006
				ALT; AC-C		KT 7005

#### 18.350

10518 ccm	257 kW	D 2066 LF 03;D 2066 LF 13	05.04 -	ALT	MTR-CODE: D2066LF01; MOD: 18.310FAC; - AC	8 PK 1635 TM
				ALT	MTR-CODE: D2066LF01; MOD: 18.310FAC; + AC	8 PK 1920 TM

#### 18.350; 18.360

10518 ccm	257-265 kW	D 2066 LF 03;D 2066 LF 13;D 2066 LF 27;D 2066 LF 33;D 2066 LF 38	05.04 -	ALT	MTR-CODE: D2066LF01; MOD: 18.310FAC; - AC	8 PK 1635 TM
				ALT	MTR-CODE: D2066LF01; MOD: 18.310FAC; + AC	8 PK 1920 TM
		D 2066 LF 03;D 2066 LF 13;D 2066 LF 33;D 2066 LF 38		ALT	MTR-CODE: D2066LF01; MOD: 18.310FAC; - AC	8 PK 1635 TM
				ALT	MTR-CODE: D2066LF01; MOD: 18.310FAC; + AC	8 PK 1920 TM

#### 18.360

11967 ccm	265 kW	D 2866 LF27	04.00 -	FAN	MTR-CODE: D 2866 LF26; MOD: 18.310 FAC; REQ: 2	AVX 13 x 1275 TM
		D 2866 LF27;D 2866 LF37		AC-C	MTR-CODE: D2866LF26; MOD: 18.310FAC	8 PK 1376 TM
				FAN	MTR-CODE: D 2866 LF26; MOD: 18.310 FAC; REQ: 2	AVX 13 x 1275 TM
				AC-C	MTR-CODE: D2866LF26; MOD: 18.310FAC	8 PK 1376 TM
				ALT		KT 7006
				ALT; AC-C		KT 7005

#### 18.390

10518 ccm	287 kW	D 2066 LF 02;D 2066 LF 12	05.04 -	ALT	MTR-CODE: D2066LF01; MOD: 18.310FAC; - AC	8 PK 1635 TM
				ALT	MTR-CODE: D2066LF01; MOD: 18.310FAC; + AC	8 PK 1920 TM

#### 18.390; 18.400

10518 ccm	287-294 kW	D 2066 LF 02;D 2066 LF 12;D 2066 LF 26;D 2066 LF 32;D 2066 LF 37	05.04 -	ALT	MTR-CODE: D2066LF01; MOD: 18.310FAC; - AC	8 PK 1635 TM
				ALT	MTR-CODE: D2066LF01; MOD: 18.310FAC; + AC	8 PK 1920 TM
		D 2066 LF 02;D 2066 LF 12;D 2066 LF 32;D 2066 LF 37		ALT	MTR-CODE: D2066LF01; MOD: 18.310FAC; - AC	8 PK 1635 TM
				ALT	MTR-CODE: D2066LF01; MOD: 18.310FAC; + AC	8 PK 1920 TM

#### 18.410

11967 ccm	301 kW	D 2866 LF28	04.00 -	FAN	MTR-CODE: D 2866 LF26; MOD: 18.310 FAC; REQ: 2	AVX 13 x 1275 TM
		D 2866 LF28;D 2866 LF32		AC-C	MTR-CODE: D2866LF26; MOD: 18.310FAC	8 PK 1376 TM
				FAN	MTR-CODE: D 2866 LF26; MOD: 18.310 FAC; REQ: 2	AVX 13 x 1275 TM
				AC-C	MTR-CODE: D2866LF26; MOD: 18.310FAC	8 PK 1376 TM
				ALT		KT 7006
				ALT; AC-C		KT 7005

#### 18.410; 18420

11967 ccm	301-309 kW	D 2866 LF28	04.00 -	FAN	MTR-CODE: D 2866 LF26; MOD: 18.310 FAC; REQ: 2	AVX 13 x 1275 TM
		D 2866 LF28;D 2866 LF32		AC-C	MTR-CODE: D2866LF26; MOD: 18.310FAC	8 PK 1376 TM
				FAN	MTR-CODE: D 2866 LF26; MOD: 18.310 FAC; REQ: 2	AVX 13 x 1275 TM
				AC-C	MTR-CODE: D2866LF26; MOD: 18.310FAC	8 PK 1376 TM
				ALT		KT 7006
				ALT; AC-C		KT 7005



# MAN

## TGA

<b>18.430</b>						
10518 ccm	316 kW	D 2066 LF 01;D 2066 LF 11	05.04 -	ALT	MTR-CODE: D2066LF01; MOD: 18.310FAC; - AC	8 PK 1635 TM
				ALT	MTR-CODE: D2066LF01; MOD: 18.310FAC; + AC	8 PK 1920 TM
<b>18.430; 18.440</b>						
10518 ccm	316-324 kW	D 2066 LF 01;D 2066 LF 11;D 2066 LF 25;D 2066 LF 31;D 2066 LF 36	05.04 -	ALT	MTR-CODE: D2066LF01; MOD: 18.310FAC; - AC	8 PK 1635 TM
				ALT	MTR-CODE: D2066LF01; MOD: 18.310FAC; + AC	8 PK 1920 TM
		D 2066 LF 01;D 2066 LF 11;D 2066 LF 31;D 2066 LF 36		ALT	MTR-CODE: D2066LF01; MOD: 18.310FAC; - AC	8 PK 1635 TM
				ALT	MTR-CODE: D2066LF01; MOD: 18.310FAC; + AC	8 PK 1920 TM
<b>18.460</b>						
12816 ccm	338 kW	D 2876 LF 04;D 2876 LF 07	04.00 -	AC-C	MTR-CODE: D 2876 LF 04; OE-NO.: 06580732352; REQ: 2	AVX 13 x 1350 TM
				AC-C	MTR-CODE: D2876LF04; OE-NO.: 51968200238	8 PK 880 TM
				AC-C	MTR-CODE: D2876LF04; OE-NO.: 51968200239	8 PK 1376 TM
				ALT	MTR-CODE: D2876LF04	14 PK 1305 TM
				ALT	MTR-CODE: D2876LF04	5 PK 1482 TM
				HYD-P	MTR-CODE: D2876LF04	8 PK 1515 TM
				ALT		KT 7006
				ALT; AC-C		KT 7005
<b>18.480</b>						
12816 ccm	353 kW	D 2876 LF 12	09.02 -	AC-C	MTR-CODE: D 2876 LF 04; OE-NO.: 06580732352; REQ: 2	AVX 13 x 1350 TM
				AC-C	MTR-CODE: D2876LF04; OE-NO.: 51968200238	8 PK 880 TM
				AC-C	MTR-CODE: D2876LF04; OE-NO.: 51968200239	8 PK 1376 TM
				ALT	MTR-CODE: D2876LF04	14 PK 1305 TM
				ALT	MTR-CODE: D2876LF04	5 PK 1482 TM
				HYD-P	MTR-CODE: D2876LF04	8 PK 1515 TM
				ALT		KT 7006
				ALT; AC-C		KT 7005
		D 2876 LF 12;D 2876 LF 25		AC-C	MTR-CODE: D 2876 LF 04; OE-NO.: 06580732352; REQ: 2	AVX 13 x 1350 TM
				AC-C	MTR-CODE: D2876LF04; OE-NO.: 51968200238	8 PK 880 TM
				AC-C	MTR-CODE: D2876LF04; OE-NO.: 51968200239	8 PK 1376 TM
				ALT	MTR-CODE: D2876LF04	14 PK 1305 TM
				ALT	MTR-CODE: D2876LF04	5 PK 1482 TM
				HYD-P	MTR-CODE: D2876LF04	8 PK 1515 TM
				ALT		KT 7006
				ALT; AC-C		KT 7005
<b>18.510</b>						
12816 ccm	375 kW	D 2876 LF 05	04.00 -	AC-C	MTR-CODE: D 2876 LF 04; OE-NO.: 06580732352; REQ: 2	AVX 13 x 1350 TM
				AC-C	MTR-CODE: D2876LF04; OE-NO.: 51968200238	8 PK 880 TM
				AC-C	MTR-CODE: D2876LF04; OE-NO.: 51968200239	8 PK 1376 TM
				ALT	MTR-CODE: D2876LF04	14 PK 1305 TM
				ALT	MTR-CODE: D2876LF04	5 PK 1482 TM
				HYD-P	MTR-CODE: D2876LF04	8 PK 1515 TM
				ALT		KT 7006
				ALT; AC-C		KT 7005
<b>18.530</b>						
12816 ccm	390 kW	D 2876 LF 13	09.02 -	AC-C	MTR-CODE: D 2876 LF 04; OE-NO.: 06580732352; REQ: 2	AVX 13 x 1350 TM
				AC-C	MTR-CODE: D2876LF04; OE-NO.: 51968200238	8 PK 880 TM
				AC-C	MTR-CODE: D2876LF04; OE-NO.: 51968200239	8 PK 1376 TM
				ALT	MTR-CODE: D2876LF04	14 PK 1305 TM
				ALT	MTR-CODE: D2876LF04	5 PK 1482 TM
				HYD-P	MTR-CODE: D2876LF04	8 PK 1515 TM
				ALT		KT 7006
				ALT; AC-C		KT 7005
<b>24.360</b>						
11967 ccm	265 kW	D 2866 LF27	09.01 -	AC-C	OE-NO.: 06580732352; MOD: 24.360 FNLLC/N; REQ: 2	AVX 13 x 1350 TM
				AC-C	OE-NO.: 51968200238; MOD: 24.360FNLLC/N	8 PK 880 TM
				AC-C	OE-NO.: 51968200239; MOD: 24.360FNLLC/N	8 PK 1376 TM
				ALT	MOD: 24.360FNLLC/N	14 PK 1305 TM



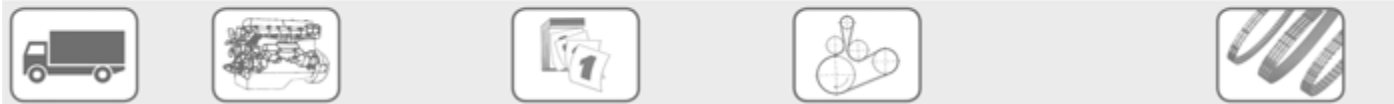

## MAN

### TGA

#### 24.360

11967 ccm	265 kW	D 2866 LF27	09.01 -	ALT	MOD: 24.360FNLLC/N	5 PK 1482 TM
				HYD-P	MOD: 24.360FNLLC/N	8 PK 1515 TM

#### 24.460

12816 ccm	338 kW	D 2876 LF 04	09.01 -	AC-C	OE-NO.: 06580732352; MOD: 24.460 FNLLC/N; REQ: 2	AVX 13 x 1350 TM
				AC-C	OE-NO.: 51968200238; MOD: 24.460FNLLC/N	8 PK 880 TM
				AC-C	OE-NO.: 51968200239; MOD: 24.460FNLLC/N	8 PK 1376 TM
				ALT	MOD: 24.460FNLLC/N	14 PK 1305 TM
				ALT	MOD: 24.460FNLLC/N	5 PK 1482 TM
				HYD-P	MOD: 24.460FNLLC/N	8 PK 1515 TM

#### 24.480

12816 ccm	353 kW	D 2876 LF 12	09.02 -	AC-C	MTR-CODE: D 2876 LF 04; OE-NO.: 06580732352; MOD: 24.460 FNLLC/N; REQ: 2	AVX 13 x 1350 TM
				AC-C	MTR-CODE: D2876LF04; OE-NO.: 51968200238; MOD: 24.460FNLLC/N	8 PK 880 TM
				AC-C	MTR-CODE: D2876LF04; OE-NO.: 51968200239; MOD: 24.460FNLLC/N	8 PK 1376 TM
				ALT	MTR-CODE: D2876LF04; MOD: 24.460FNLLC/N	14 PK 1305 TM
				ALT	MTR-CODE: D2876LF04; MOD: 24.460FNLLC/N	5 PK 1482 TM
				HYD-P	MTR-CODE: D2876LF04; MOD: 24.460FNLLC/N	8 PK 1515 TM

#### 24.510

12816 ccm	375 kW	D 2876 LF 05	09.01 -	AC-C	MTR-CODE: D 2876 LF 04; OE-NO.: 06580732352; MOD: 24.460 FNLLC/N; REQ: 2	AVX 13 x 1350 TM
				AC-C	MTR-CODE: D2876LF04; OE-NO.: 51968200238; MOD: 24.460FNLLC/N	8 PK 880 TM
				AC-C	MTR-CODE: D2876LF04; OE-NO.: 51968200239; MOD: 24.460FNLLC/N	8 PK 1376 TM
				ALT	MTR-CODE: D2876LF04; MOD: 24.460FNLLC/N	14 PK 1305 TM
				ALT	MTR-CODE: D2876LF04; MOD: 24.460FNLLC/N	5 PK 1482 TM
				HYD-P	MTR-CODE: D2876LF04; MOD: 24.460FNLLC/N	8 PK 1515 TM

#### 24.530

12816 ccm	390 kW	D 2876 LF 13	09.01 -	AC-C	MTR-CODE: D 2876 LF 04; OE-NO.: 06580732352; MOD: 24.460 FNLLC/N; REQ: 2	AVX 13 x 1350 TM
				AC-C	MTR-CODE: D2876LF04; OE-NO.: 51968200238; MOD: 24.460FNLLC/N	8 PK 880 TM
				AC-C	MTR-CODE: D2876LF04; OE-NO.: 51968200239; MOD: 24.460FNLLC/N	8 PK 1376 TM
				ALT	MTR-CODE: D2876LF04; MOD: 24.460FNLLC/N	14 PK 1305 TM
				ALT	MTR-CODE: D2876LF04; MOD: 24.460FNLLC/N	5 PK 1482 TM
				HYD-P	MTR-CODE: D2876LF04; MOD: 24.460FNLLC/N	8 PK 1515 TM

#### 26.280

6871 ccm	206 kW	D 0836 LF 41	11.02 -	AC-C	OE-NO.: 51968200304	4 PK 1455 TM
				AC-C	OE-NO.: 51968200314	4 PK 1380 TM
				ALT	OE-NO.: 51968200243	8 PK 1275 TM
				ALT	OE-NO.: 51968200280	8 PK 1327 TM

#### 26.310

11967 ccm	228 kW	D 2866 LF26	09.00 -	AC-C	OE-NO.: 06580732352; MOD: 26.310 FD-TM; REQ: 2	AVX 13 x 1350 TM
				AC-C	OE-NO.: 51968200238; MOD: 26.310FD-TM	8 PK 880 TM
				AC-C	OE-NO.: 51968200239; MOD: 26.310FD-TM	8 PK 1376 TM
				ALT	MOD: 26.310FD-TM	14 PK 1305 TM
				ALT	MOD: 26.310FD-TM	5 PK 1482 TM
				HYD-P	MOD: 26.310FD-TM	8 PK 1515 TM
		D 2866 LF26;D 2866 LF36		AC-C	MTR-CODE: D 2866 LF26; OE-NO.: 06580732352; MOD: 26.310 FD-TM; REQ: 2	AVX 13 x 1350 TM
				AC-C	OE-NO.: 06580732352; MOD: 26.310 FD-TM; REQ: 2	AVX 13 x 1350 TM
				AC-C	MTR-CODE: D2866LF26; OE-NO.: 51968200238; MOD: 26.310FD-TM	8 PK 880 TM
				AC-C	MTR-CODE: D2866LF26; OE-NO.: 51968200239; MOD: 26.310FD-TM	8 PK 1376 TM
				ALT	MTR-CODE: D2866LF26; MOD: 26.310FD-TM	14 PK 1305 TM
				ALT	MTR-CODE: D2866LF26; MOD: 26.310FD-TM	5 PK 1482 TM
				HYD-P	MTR-CODE: D2866LF26; MOD: 26.310FD-TM	8 PK 1515 TM
				ALT		KT 7006
				ALT; AC-C		KT 7005

#### 26.330

6871 ccm	240 kW	D 0836 LF 44	11.02 -	AC-C	MTR-CODE: D0836LF41; OE-NO.: 51968200304	4 PK 1455 TM
				AC-C	MTR-CODE: D0836LF41; OE-NO.: 51968200314	4 PK 1380 TM



# MAN

## TGA

<b>26.330</b>						
6871 ccm	240 kW	D 0836 LF 44	11.02 -	ALT	MTR-CODE: D0836LF41; OE-NO.: 51968200243	<b>8 PK 1275 TM</b>
				ALT	MTR-CODE: D0836LF41; OE-NO.: 51968200280	<b>8 PK 1327 TM</b>
<b>26.360</b>						
11967 ccm	265 kW	D 2866 LF27	09.00 -	AC-C	MTR-CODE: D 2866 LF26; OE-NO.: 06580732352; MOD: 26.310 FD-TM; REQ: 2	<b>AVX 13 x 1350 TM</b>
				AC-C	MTR-CODE: D2866LF26; OE-NO.: 51968200238; MOD: 26.310FD-TM	<b>8 PK 880 TM</b>
				AC-C	MTR-CODE: D2866LF26; OE-NO.: 51968200239; MOD: 26.310FD-TM	<b>8 PK 1376 TM</b>
				ALT	MTR-CODE: D2866LF26; MOD: 26.310FD-TM	<b>14 PK 1305 TM</b>
				ALT	MTR-CODE: D2866LF26; MOD: 26.310FD-TM	<b>5 PK 1482 TM</b>
		D 2866 LF27;D 2866 LF37		HYD-P	MTR-CODE: D2866LF26; MOD: 26.310FD-TM	<b>8 PK 1515 TM</b>
				AC-C	MTR-CODE: D 2866 LF26; OE-NO.: 06580732352; MOD: 26.310 FD-TM; REQ: 2	<b>AVX 13 x 1350 TM</b>
				FAN	MTR-CODE: D 2866 LF26; MOD: 18.310 FAC; REQ: 2	<b>AVX 13 x 1275 TM</b>
				AC-C	MTR-CODE: D2866LF26; MOD: 18.310FAC	<b>8 PK 1376 TM</b>
				AC-C	MTR-CODE: D2866LF26; OE-NO.: 51968200238; MOD: 26.310FD-TM	<b>8 PK 880 TM</b>
				AC-C	MTR-CODE: D2866LF26; OE-NO.: 51968200239; MOD: 26.310FD-TM	<b>8 PK 1376 TM</b>
				ALT	MTR-CODE: D2866LF26; MOD: 26.310FD-TM	<b>14 PK 1305 TM</b>
				ALT	MTR-CODE: D2866LF26; MOD: 26.310FD-TM	<b>5 PK 1482 TM</b>
				HYD-P	MTR-CODE: D2866LF26; MOD: 26.310FD-TM	<b>8 PK 1515 TM</b>
				ALT		<b>KT 7006</b>
				ALT; AC-C		<b>KT 7005</b>
<b>26.410</b>						
11967 ccm	301 kW	D 2866 LF28	04.00 -	AC-C	MTR-CODE: D 2866 LF26; OE-NO.: 06580732352; MOD: 26.310 FD-TM; REQ: 2	<b>AVX 13 x 1350 TM</b>
				AC-C	MTR-CODE: D2866LF26; OE-NO.: 51968200238; MOD: 26.310FD-TM	<b>8 PK 880 TM</b>
				AC-C	MTR-CODE: D2866LF26; OE-NO.: 51968200239; MOD: 26.310FD-TM	<b>8 PK 1376 TM</b>
				ALT	MTR-CODE: D2866LF26; MOD: 26.310FD-TM	<b>14 PK 1305 TM</b>
				ALT	MTR-CODE: D2866LF26; MOD: 26.310FD-TM	<b>5 PK 1482 TM</b>
		D 2866 LF28;D 2866 LF32		HYD-P	MTR-CODE: D2866LF26; MOD: 26.310FD-TM	<b>8 PK 1515 TM</b>
				AC-C	MTR-CODE: D 2866 LF26; OE-NO.: 06580732352; MOD: 26.310 FD-TM; REQ: 2	<b>AVX 13 x 1350 TM</b>
				AC-C	MTR-CODE: D2866LF26; OE-NO.: 51968200238; MOD: 26.310FD-TM	<b>8 PK 880 TM</b>
				AC-C	MTR-CODE: D2866LF26; OE-NO.: 51968200239; MOD: 26.310FD-TM	<b>8 PK 1376 TM</b>
				ALT	MTR-CODE: D2866LF26; MOD: 26.310FD-TM	<b>14 PK 1305 TM</b>
				ALT	MTR-CODE: D2866LF26; MOD: 26.310FD-TM	<b>5 PK 1482 TM</b>
				ALT	MTR-CODE: D2866LF26; OE-NO.: 51968200238; MOD: 26.310FD-TM	<b>8 PK 880 TM</b>
				HYD-P	MTR-CODE: D2866LF26; MOD: 26.310FD-TM	<b>8 PK 1515 TM</b>
				ALT		<b>KT 7006</b>
				ALT; AC-C		<b>KT 7005</b>
<b>26.460</b>						
12816 ccm	338 kW	D 2876 LF 04;D 2876 LF 07	04.00 -	AC-C	MTR-CODE: D 2876 LF 04; OE-NO.: 06580732352; MOD: 26;26.460 FD-TM; REQ: 2	<b>AVX 13 x 1350 TM</b>
				AC-C	OE-NO.: 06580732352; MOD: 26;26.460 FD-TM; REQ: 2	<b>AVX 13 x 1350 TM</b>
				AC-C	MTR-CODE: D2876LF04; OE-NO.: 51968200238; MOD: 26;26.460FD-TM	<b>8 PK 880 TM</b>
				AC-C	MTR-CODE: D2876LF04; OE-NO.: 51968200239; MOD: 26;26.460FD-TM	<b>8 PK 1376 TM</b>
				ALT	MTR-CODE: D2876LF04; MOD: 26;26.460FD-TM	<b>14 PK 1305 TM</b>
				ALT	MTR-CODE: D2876LF04; MOD: 26;26.460FD-TM	<b>5 PK 1482 TM</b>
				HYD-P	MTR-CODE: D2876LF04; MOD: 26;26.460FD-TM	<b>8 PK 1515 TM</b>
				ALT		<b>KT 7006</b>
				ALT; AC-C		<b>KT 7005</b>
<b>26.480</b>						
12816 ccm	353 kW	D 2876 LF 12	09.02 -	AC-C	MTR-CODE: D 2876 LF 04; OE-NO.: 06580732352; MOD: 26;26.460 FD-TM; REQ: 2	<b>AVX 13 x 1350 TM</b>
				AC-C	MTR-CODE: D2876LF04; OE-NO.: 51968200238; MOD: 26;26.460FD-TM	<b>8 PK 880 TM</b>
				AC-C	MTR-CODE: D2876LF04; OE-NO.: 51968200239; MOD: 26;26.460FD-TM	<b>8 PK 1376 TM</b>
				ALT	MTR-CODE: D2876LF04; MOD: 26;26.460FD-TM	<b>14 PK 1305 TM</b>

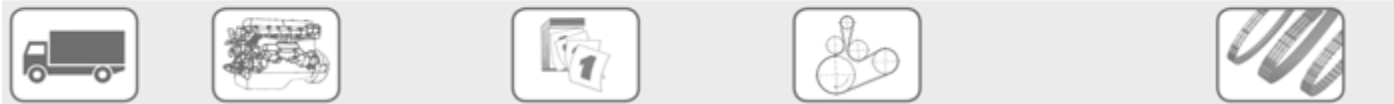

## MAN

### TGA

#### 26.480

12816 ccm	353 kW	D 2876 LF 12	09.02 -	ALT	MTR-CODE: D2876LF04; MOD: 26;26.460FD-TM	5 PK 1482 TM
				HYD-P	MTR-CODE: D2876LF04; MOD: 26;26.460FD-TM	8 PK 1515 TM
				ALT		KT 7006
				ALT; AC-C		KT 7005
		D 2876 LF 12;D 2876 LF 25		AC-C	MTR-CODE: D 2876 LF 04; OE-NO.: 06580732352; MOD: 26;26.460 FD-TM; REQ: 2	AVX 13 x 1350 TM
				AC-C	MTR-CODE: D2876LF04; OE-NO.: 51968200238; MOD: 26;26.460FD-TM	8 PK 880 TM
				AC-C	MTR-CODE: D2876LF04; OE-NO.: 51968200239; MOD: 26;26.460FD-TM	8 PK 1376 TM
				ALT	MTR-CODE: D2876LF04; MOD: 26;26.460FD-TM	14 PK 1305 TM
				ALT	MTR-CODE: D2876LF04; MOD: 26;26.460FD-TM	5 PK 1482 TM
				HYD-P	MTR-CODE: D2876LF04; MOD: 26;26.460FD-TM	8 PK 1515 TM
				ALT		KT 7006
				ALT; AC-C		KT 7005

#### 26.510

12816 ccm	375 kW	D 2876 LF 05	12.00 -	AC-C	MTR-CODE: D 2876 LF 04; OE-NO.: 06580732352; MOD: 26;26.460 FD-TM; REQ: 2	AVX 13 x 1350 TM
				AC-C	MTR-CODE: D2876LF04; OE-NO.: 51968200238; MOD: 26;26.460FD-TM	8 PK 880 TM
				AC-C	MTR-CODE: D2876LF04; OE-NO.: 51968200239; MOD: 26;26.460FD-TM	8 PK 1376 TM
				ALT	MTR-CODE: D2876LF04; MOD: 26;26.460FD-TM	14 PK 1305 TM
				ALT	MTR-CODE: D2876LF04; MOD: 26;26.460FD-TM	5 PK 1482 TM
				HYD-P	MTR-CODE: D2876LF04; MOD: 26;26.460FD-TM	8 PK 1515 TM
				ALT		KT 7006
				ALT; AC-C		KT 7005

#### 26.530

12816 ccm	390 kW	D 2876 LF 13	01.01 -	AC-C	MTR-CODE: D 2876 LF 04; OE-NO.: 06580732352; MOD: 26;26.460 FD-TM; REQ: 2	AVX 13 x 1350 TM
				AC-C	MTR-CODE: D2876LF04; OE-NO.: 51968200238; MOD: 26;26.460FD-TM	8 PK 880 TM
				AC-C	MTR-CODE: D2876LF04; OE-NO.: 51968200239; MOD: 26;26.460FD-TM	8 PK 1376 TM
				ALT	MTR-CODE: D2876LF04; MOD: 26;26.460FD-TM	14 PK 1305 TM
				ALT	MTR-CODE: D2876LF04; MOD: 26;26.460FD-TM	5 PK 1482 TM
				HYD-P	MTR-CODE: D2876LF04; MOD: 26;26.460FD-TM	8 PK 1515 TM
				ALT		KT 7006
				ALT; AC-C		KT 7005

#### 28.310

11967 ccm	228 kW	D 2866 LF26	09.02 -	AC-C	OE-NO.: 06580732352; MOD: 28.310FNLC; REQ: 2	AVX 13 x 1350 TM
				AC-C	OE-NO.: 51968200238; MOD: 28.310FNLC	8 PK 880 TM
				AC-C	OE-NO.: 51968200239; MOD: 28.310FNLC	8 PK 1376 TM
				ALT	MOD: 28.310FNLC	14 PK 1305 TM
				ALT	MOD: 28.310FNLC	5 PK 1482 TM
				HYD-P	MOD: 28.310FNLC	8 PK 1515 TM

#### 28.360

11967 ccm	265 kW	D 2866 LF27	09.02 -	AC-C	MTR-CODE: D 2866 LF26; OE-NO.: 06580732352; MOD: 28.310 FNLC; REQ: 2	AVX 13 x 1350 TM
				AC-C	MTR-CODE: D2866LF26; OE-NO.: 51968200238; MOD: 28.310FNLC	8 PK 880 TM
				AC-C	MTR-CODE: D2866LF26; OE-NO.: 51968200239; MOD: 28.310FNLC	8 PK 1376 TM
				ALT	MTR-CODE: D2866LF26; MOD: 28.310FNLC	14 PK 1305 TM
				ALT	MTR-CODE: D2866LF26; MOD: 28.310FNLC	5 PK 1482 TM
				HYD-P	MTR-CODE: D2866LF26; MOD: 28.310FNLC	8 PK 1515 TM

#### 28.410

11967 ccm	301 kW	D 2866 LF28	09.02 -	AC-C	MTR-CODE: D 2866 LF26; OE-NO.: 06580732352; MOD: 28.310 FNLC; REQ: 2	AVX 13 x 1350 TM
				AC-C	MTR-CODE: D2866LF26; OE-NO.: 51968200238; MOD: 28.310FNLC	8 PK 880 TM
				AC-C	MTR-CODE: D2866LF26; OE-NO.: 51968200239; MOD: 28.310FNLC	8 PK 1376 TM
				ALT	MTR-CODE: D2866LF26; MOD: 28.310FNLC	14 PK 1305 TM
				ALT	MTR-CODE: D2866LF26; MOD: 28.310FNLC	5 PK 1482 TM
				HYD-P	MTR-CODE: D2866LF26; MOD: 28.310FNLC	8 PK 1515 TM

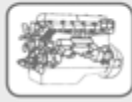

# MAN

## TGA

<b>28.460</b>						
12816 ccm	338 kW	D 2876 LF 04	09.02 -	AC-C	OE-NO.: 06580732352; MOD: 28.460 FNLC; REQ: 2	AVX 13 x 1350 TM
				AC-C	OE-NO.: 51968200238; MOD: 28.460FNLC	8 PK 880 TM
				AC-C	OE-NO.: 51968200239; MOD: 28.460FNLC	8 PK 1376 TM
				ALT	MOD: 28.460FNLC	14 PK 1305 TM
				ALT	MOD: 28.460FNLC	5 PK 1482 TM
				HYD-P	MOD: 28.460FNLC	8 PK 1515 TM
<b>28.480</b>						
12816 ccm	353 kW	D 2876 LF 12	09.02 -	AC-C	MTR-CODE: D 2876 LF 04; OE-NO.: 06580732352; MOD: 28.460 FNLC; REQ: 2	AVX 13 x 1350 TM
				AC-C	MTR-CODE: D2876LF04; OE-NO.: 51968200238; MOD: 28.460FNLC	8 PK 880 TM
				AC-C	MTR-CODE: D2876LF04; OE-NO.: 51968200239; MOD: 28.460FNLC	8 PK 1376 TM
				ALT	MTR-CODE: D2876LF04; MOD: 28.460FNLC	14 PK 1305 TM
				ALT	MTR-CODE: D2876LF04; MOD: 28.460FNLC	5 PK 1482 TM
				HYD-P	MTR-CODE: D2876LF04; MOD: 28.460FNLC	8 PK 1515 TM
<b>28.510</b>						
12816 ccm	375 kW	D 2876 LF 05	09.02 -	AC-C	MTR-CODE: D 2876 LF 04; OE-NO.: 06580732352; MOD: 28.460 FNLC; REQ: 2	AVX 13 x 1350 TM
				AC-C	MTR-CODE: D2876LF04; OE-NO.: 51968200238; MOD: 28.460FNLC	8 PK 880 TM
				AC-C	MTR-CODE: D2876LF04; OE-NO.: 51968200239; MOD: 28.460FNLC	8 PK 1376 TM
				ALT	MTR-CODE: D2876LF04; MOD: 28.460FNLC	14 PK 1305 TM
				ALT	MTR-CODE: D2876LF04; MOD: 28.460FNLC	5 PK 1482 TM
				HYD-P	MTR-CODE: D2876LF04; MOD: 28.460FNLC	8 PK 1515 TM
<b>28.530</b>						
12816 ccm	390 kW	D 2876 LF 13	09.02 -	AC-C	MTR-CODE: D 2876 LF 04; OE-NO.: 06580732352; MOD: 28.460 FNLC; REQ: 2	AVX 13 x 1350 TM
				AC-C	MTR-CODE: D2876LF04; OE-NO.: 51968200238; MOD: 28.460FNLC	8 PK 880 TM
				AC-C	MTR-CODE: D2876LF04; OE-NO.: 51968200239; MOD: 28.460FNLC	8 PK 1376 TM
				ALT	MTR-CODE: D2876LF04; MOD: 28.460FNLC	14 PK 1305 TM
				ALT	MTR-CODE: D2876LF04; MOD: 28.460FNLC	5 PK 1482 TM
				HYD-P	MTR-CODE: D2876LF04; MOD: 28.460FNLC	8 PK 1515 TM
<b>32.310</b>						
11967 ccm	228 kW	D 2866 LF26	01.02 -	AC-C	OE-NO.: 06580732352; MOD: 32.310; REQ: 2	AVX 13 x 1350 TM
				AC-C	OE-NO.: 51968200238; MOD: 32.310	8 PK 880 TM
				AC-C	OE-NO.: 51968200239; MOD: 32.310	8 PK 1376 TM
				ALT	MOD: 32.310	14 PK 1305 TM
				ALT	MOD: 32.310	5 PK 1482 TM
				HYD-P	MOD: 32.310	8 PK 1515 TM
				ALT		KT 7006
				ALT; AC-C		KT 7005
<b>32.360</b>						
11967 ccm	265 kW	D 2866 LF27	01.02 -	AC-C	MTR-CODE: D 2866 LF26; OE-NO.: 06580732352; MOD: 32.310; REQ: 2	AVX 13 x 1350 TM
				AC-C	MTR-CODE: D2866LF26; OE-NO.: 51968200238; MOD: 32.310	8 PK 880 TM
				AC-C	MTR-CODE: D2866LF26; OE-NO.: 51968200239; MOD: 32.310	8 PK 1376 TM
				ALT	MTR-CODE: D2866LF26; MOD: 32.310	14 PK 1305 TM
				ALT	MTR-CODE: D2866LF26; MOD: 32.310	5 PK 1482 TM
				HYD-P	MTR-CODE: D2866LF26; MOD: 32.310	8 PK 1515 TM
				ALT		KT 7006
				ALT; AC-C		KT 7005
<b>32.410</b>						
11967 ccm	301 kW	D 2866 LF28	01.02 -	AC-C	MTR-CODE: D 2866 LF26; OE-NO.: 06580732352; MOD: 32.310; REQ: 2	AVX 13 x 1350 TM
				AC-C	MTR-CODE: D2866LF26; OE-NO.: 51968200238; MOD: 32.310	8 PK 880 TM
				AC-C	MTR-CODE: D2866LF26; OE-NO.: 51968200239; MOD: 32.310	8 PK 1376 TM
				ALT	MTR-CODE: D2866LF26; MOD: 32.310	14 PK 1305 TM
				ALT	MTR-CODE: D2866LF26; MOD: 32.310	5 PK 1482 TM
				HYD-P	MTR-CODE: D2866LF26; MOD: 32.310	8 PK 1515 TM
				ALT		KT 7006

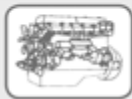

## MAN

### TGA

#### 32.410

11967 ccm 301 kW D 2866 LF28 01.02 - ALT; AC-C **KT 7005**

#### 32.460

12816 ccm 338 kW D 2876 LF 04 01.02 - AC-C OE-NO.: 06580732352; MOD: 32.460 FFD-TM; REQ: 2 **AVX 13 x 1350 TM**  
 AC-C OE-NO.: 51968200238; MOD: 32.460FFD-TM **8 PK 880 TM**  
 AC-C OE-NO.: 51968200239; MOD: 32.460FFD-TM **8 PK 1376 TM**  
 ALT MOD: 32.460FFD-TM **14 PK 1305 TM**  
 ALT MOD: 32.460FFD-TM **5 PK 1482 TM**  
 HYD-P MOD: 32.460FFD-TM **8 PK 1515 TM**  
 ALT **KT 7006**  
 ALT; AC-C **KT 7005**

#### 32.480

12816 ccm 353 kW D 2876 LF 12 09.02 - AC-C MTR-CODE: D 2876 LF 04; OE-NO.: 06580732352; MOD: 32.460 FFD-TM; REQ: 2 **AVX 13 x 1350 TM**  
 AC-C MTR-CODE: D2876LF04; OE-NO.: 51968200238; MOD: 32.460FFD-TM **8 PK 880 TM**  
 AC-C MTR-CODE: D2876LF04; OE-NO.: 51968200239; MOD: 32.460FFD-TM **8 PK 1376 TM**  
 ALT MTR-CODE: D2876LF04; MOD: 32.460FFD-TM **14 PK 1305 TM**  
 ALT MTR-CODE: D2876LF04; MOD: 32.460FFD-TM **5 PK 1482 TM**  
 HYD-P MTR-CODE: D2876LF04; MOD: 32.460FFD-TM **8 PK 1515 TM**  
 ALT; AC-C **KT 7005**

#### 33.360

11967 ccm 265 kW D 2866 LF27 10.00 - AC-C OE-NO.: 06580732352; MOD: 33.360 FD-TM; REQ: 2 **AVX 13 x 1350 TM**  
 AC-C OE-NO.: 51968200238; MOD: 33.360FD-TM **8 PK 880 TM**  
 AC-C OE-NO.: 51968200239; MOD: 33.360FD-TM **8 PK 1376 TM**  
 ALT MOD: 33.360FD-TM **14 PK 1305 TM**  
 ALT MOD: 33.360FD-TM **5 PK 1482 TM**  
 HYD-P MOD: 33.360FD-TM **8 PK 1515 TM**  
 D 2866 LF27;D 2866 LF37 AC-C MTR-CODE: D 2866 LF27; OE-NO.: 06580732352; MOD: 33.360 FD-TM; REQ: 2 **AVX 13 x 1350 TM**  
 AC-C OE-NO.: 06580732352; MOD: 33.360 FD-TM; REQ: 2 **AVX 13 x 1350 TM**  
 AC-C MTR-CODE: D2866LF27; OE-NO.: 51968200238; MOD: 33.360FD-TM **8 PK 880 TM**  
 AC-C MTR-CODE: D2866LF27; OE-NO.: 51968200239; MOD: 33.360FD-TM **8 PK 1376 TM**  
 ALT MTR-CODE: D2866LF27; MOD: 33.360FD-TM **14 PK 1305 TM**  
 ALT MTR-CODE: D2866LF27; MOD: 33.360FD-TM **5 PK 1482 TM**  
 HYD-P MTR-CODE: D2866LF27; MOD: 33.360FD-TM **8 PK 1515 TM**  
 ALT **KT 7006**  
 ALT; AC-C **KT 7005**

#### 33.410

11967 ccm 301 kW D 2866 LF28 10.00 - AC-C MTR-CODE: D 2866 LF27; OE-NO.: 06580732352; MOD: 33.360 FD-TM; REQ: 2 **AVX 13 x 1350 TM**  
 AC-C MTR-CODE: D2866LF27; OE-NO.: 51968200238; MOD: 33.360FD-TM **8 PK 880 TM**  
 AC-C MTR-CODE: D2866LF27; OE-NO.: 51968200239; MOD: 33.360FD-TM **8 PK 1376 TM**  
 ALT MTR-CODE: D2866LF27; MOD: 33.360FD-TM **14 PK 1305 TM**  
 ALT MTR-CODE: D2866LF27; MOD: 33.360FD-TM **5 PK 1482 TM**  
 HYD-P MTR-CODE: D2866LF27; MOD: 33.360FD-TM **8 PK 1515 TM**  
 ALT **KT 7006**  
 ALT; AC-C **KT 7005**  
 D 2866 LF28;D 2866 LF32 AC-C MTR-CODE: D 2866 LF27; OE-NO.: 06580732352; MOD: 33.360 FD-TM; REQ: 2 **AVX 13 x 1350 TM**  
 AC-C MTR-CODE: D2866LF27; OE-NO.: 51968200238; MOD: 33.360FD-TM **8 PK 880 TM**  
 AC-C MTR-CODE: D2866LF27; OE-NO.: 51968200239; MOD: 33.360FD-TM **8 PK 1376 TM**  
 ALT MTR-CODE: D2866LF27; MOD: 33.360FD-TM **14 PK 1305 TM**  
 ALT MTR-CODE: D2866LF27; MOD: 33.360FD-TM **5 PK 1482 TM**  
 HYD-P MTR-CODE: D2866LF27; MOD: 33.360FD-TM **8 PK 1515 TM**  
 ALT **KT 7006**  
 ALT; AC-C **KT 7005**

#### 33.460

12816 ccm 338 kW D 2876 LF 04 09.02 - AC-C OE-NO.: 06580732352; MOD: 33.460 FD-TM; REQ: 2 **AVX 13 x 1350 TM**



# MAN

## TGA

<b>33.460</b>	12816 ccm 338 kW	D 2876 LF 04	09.02 -	AC-C	OE-NO.: 51968200238; MOD: 33.460FD-TM	<b>8 PK 880 TM</b>
				AC-C	OE-NO.: 51968200239; MOD: 33.460FD-TM	<b>8 PK 1376 TM</b>
				ALT	MOD: 33.460FD-TM	<b>14 PK 1305 TM</b>
				ALT	MOD: 33.460FD-TM	<b>5 PK 1482 TM</b>
				HYD-P	MOD: 33.460FD-TM	<b>8 PK 1515 TM</b>
				ALT		<b>KT 7006</b>
				ALT; AC-C		<b>KT 7005</b>
		D 2876 LF 04;D 2876 LF 07		AC-C	MTR-CODE: D 2876 LF 04; OE-NO.: 06580732352; MOD: 33.460 FD-TM; REQ: 2	<b>AVX 13 x 1350 TM</b>
				AC-C	MTR-CODE: D2876LF04; OE-NO.: 51968200238; MOD: 33.460FD-TM	<b>8 PK 880 TM</b>
				AC-C	MTR-CODE: D2876LF04; OE-NO.: 51968200239; MOD: 33.460FD-TM	<b>8 PK 1376 TM</b>
				ALT	MTR-CODE: D2876LF04; MOD: 33.460FD-TM	<b>14 PK 1305 TM</b>
				ALT	MTR-CODE: D2876LF04; MOD: 33.460FD-TM	<b>5 PK 1482 TM</b>
				HYD-P	MTR-CODE: D2876LF04; MOD: 33.460FD-TM	<b>8 PK 1515 TM</b>
				ALT		<b>KT 7006</b>
				ALT; AC-C		<b>KT 7005</b>

<b>33.480</b>	12816 ccm 353 kW	D 2876 LF 12	09.02 -	AC-C	MTR-CODE: D 2876 LF 04; OE-NO.: 06580732352; MOD: 33.460 FD-TM; REQ: 2	<b>AVX 13 x 1350 TM</b>
				AC-C	MTR-CODE: D2876LF04; OE-NO.: 51968200238; MOD: 33.460FD-TM	<b>8 PK 880 TM</b>
				AC-C	MTR-CODE: D2876LF04; OE-NO.: 51968200239; MOD: 33.460FD-TM	<b>8 PK 1376 TM</b>
				ALT	MTR-CODE: D2876LF04; MOD: 33.460FD-TM	<b>14 PK 1305 TM</b>
				ALT	MTR-CODE: D2876LF04; MOD: 33.460FD-TM	<b>5 PK 1482 TM</b>
				HYD-P	MTR-CODE: D2876LF04; MOD: 33.460FD-TM	<b>8 PK 1515 TM</b>
				ALT		<b>KT 7006</b>
				ALT; AC-C		<b>KT 7005</b>
		D 2876 LF 12;D 2876 LF 25		AC-C	MTR-CODE: D 2876 LF 04; OE-NO.: 06580732352; MOD: 33.460 FD-TM; REQ: 2	<b>AVX 13 x 1350 TM</b>
				AC-C	MTR-CODE: D2876LF04; OE-NO.: 51968200238; MOD: 33.460FD-TM	<b>8 PK 880 TM</b>
				AC-C	MTR-CODE: D2876LF04; OE-NO.: 51968200239; MOD: 33.460FD-TM	<b>8 PK 1376 TM</b>
				ALT	MTR-CODE: D2876LF04; MOD: 33.460FD-TM	<b>14 PK 1305 TM</b>
				ALT	MTR-CODE: D2876LF04; MOD: 33.460FD-TM	<b>5 PK 1482 TM</b>
				HYD-P	MTR-CODE: D2876LF04; MOD: 33.460FD-TM	<b>8 PK 1515 TM</b>
				ALT		<b>KT 7006</b>
				ALT; AC-C		<b>KT 7005</b>

<b>33.510</b>	12816 ccm 375 kW	D 2876 LF 05	09.02 -	AC-C	MTR-CODE: D 2876 LF 04; OE-NO.: 06580732352; MOD: 33.460 FD-TM; REQ: 2	<b>AVX 13 x 1350 TM</b>
				AC-C	MTR-CODE: D2876LF04; OE-NO.: 51968200238; MOD: 33.460FD-TM	<b>8 PK 880 TM</b>
				AC-C	MTR-CODE: D2876LF04; OE-NO.: 51968200239; MOD: 33.460FD-TM	<b>8 PK 1376 TM</b>
				ALT	MTR-CODE: D2876LF04; MOD: 33.460FD-TM	<b>14 PK 1305 TM</b>
				ALT	MTR-CODE: D2876LF04; MOD: 33.460FD-TM	<b>5 PK 1482 TM</b>
				HYD-P	MTR-CODE: D2876LF04; MOD: 33.460FD-TM	<b>8 PK 1515 TM</b>
				ALT		<b>KT 7006</b>
				ALT; AC-C		<b>KT 7005</b>

<b>33.530</b>	12816 ccm 390 kW	D 2876 LF 13	09.02 -	AC-C	MTR-CODE: D 2876 LF 04; OE-NO.: 06580732352; MOD: 33.460 FD-TM; REQ: 2	<b>AVX 13 x 1350 TM</b>
				AC-C	MTR-CODE: D2876LF04; OE-NO.: 51968200238; MOD: 33.460FD-TM	<b>8 PK 880 TM</b>
				AC-C	MTR-CODE: D2876LF04; OE-NO.: 51968200239; MOD: 33.460FD-TM	<b>8 PK 1376 TM</b>
				ALT	MTR-CODE: D2876LF04; MOD: 33.460FD-TM	<b>14 PK 1305 TM</b>
				ALT	MTR-CODE: D2876LF04; MOD: 33.460FD-TM	<b>5 PK 1482 TM</b>
				HYD-P	MTR-CODE: D2876LF04; MOD: 33.460FD-TM	<b>8 PK 1515 TM</b>
				ALT		<b>KT 7006</b>
				ALT; AC-C		<b>KT 7005</b>

<b>41.360</b>	11967 ccm 265 kW	D 2866 LF27;D 2866 LF37	01.03 -	AC-C	MTR-CODE: D 2866 LF27; OE-NO.: 06580732352; MOD: 41.360 FFDC; REQ: 2	<b>AVX 13 x 1350 TM</b>
				AC-C	MTR-CODE: D2866LF27; OE-NO.: 51968200238; MOD: 41.360FFDC	<b>8 PK 880 TM</b>

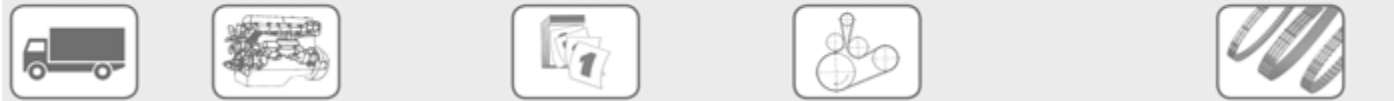

## MAN

### TGA

#### 41.360

11967 ccm	265 kW	D 2866 LF27;D 2866 LF37	01.03 -	AC-C	MTR-CODE: D2866LF27; OE-NO.: 51968200239; MOD: 41.360FFDC	8 PK 1376 TM
				ALT	MTR-CODE: D2866LF27; MOD: 41.360FFDC	14 PK 1305 TM
				ALT	MTR-CODE: D2866LF27; MOD: 41.360FFDC	5 PK 1482 TM
				HYD-P	MTR-CODE: D2866LF27; MOD: 41.360FFDC	8 PK 1515 TM
				ALT		KT 7006
				ALT; AC-C		KT 7005

#### 41.530

12816 ccm	390 kW	D 2876 LF 13	09.02 -	AC-C	OE-NO.: 06580732352; MOD: 41.530 FVDS; FVDLS; REQ: 2	AVX 13 x 1350 TM
				AC-C	OE-NO.: 51968200238; MOD: 41.530FVDS,FVDLS	8 PK 880 TM
				AC-C	OE-NO.: 51968200239; MOD: 41.530FVDS,FVDLS	8 PK 1376 TM
				ALT	MOD: 41.530FVDS,FVDLS	14 PK 1305 TM
				HYD-P	MOD: 41.530FVDS,FVDLS	8 PK 1515 TM

#### 41.660

18273 ccm	485 kW	D 2840 LF25	09.02 -	AC-C	MOD: 41.660FVDS	4 PK 1290 TM
-----------	--------	-------------	---------	------	-----------------	--------------

### TGL

#### 10.180

4580 ccm	132 kW	D 0834 LFL 41;D 0834 LFL 51;D 0834 LFL 54;D 0834 LFL 64	04.05 -	HYD-P	MTR-CODE: D 0834 LFL 41; REQ: 2	AVX 13 x 1375 TM
				AC-C	MTR-CODE: D0834LFL41; OE-NO.: 51968200314	4 PK 1380 TM
				AC-C	MTR-CODE: D0834LFL41; OE-NO.: 51968200317	4 PK 1390 TM
				ALT	MTR-CODE: D0834LFL41	8 PK 1275 TM

#### 10.210

4580 ccm	151 kW	D 0834 LFL 42;D 0834 LFL 52;D 0834 LFL 55	04.05 -	HYD-P	MTR-CODE: D 0834 LFL 41; REQ: 2	AVX 13 x 1375 TM
				AC-C	MTR-CODE: D0834LFL41; OE-NO.: 51968200314	4 PK 1380 TM
				AC-C	MTR-CODE: D0834LFL41; OE-NO.: 51968200317	4 PK 1390 TM
				ALT	MTR-CODE: D0834LFL41	8 PK 1275 TM

#### 10.240

6871 ccm	176 kW	D 0836 LFL 40;D 0836 LFL 50;D 0836 LFL 53	04.05 -	HYD-P	MTR-CODE: D 0836 LFL 40; REQ: 2	AVX 13 x 1375 TM
				AC-C	MTR-CODE: D0836LFL40; OE-NO.: 51968200314	4 PK 1380 TM
				AC-C	MTR-CODE: D0836LFL40; OE-NO.: 51968200317	4 PK 1390 TM
				ALT	MTR-CODE: D0836LFL40	8 PK 1275 TM

#### 12.180

4580 ccm	132 kW	D 0834 LFL 41;D 0834 LFL 51;D 0834 LFL 54;D 0834 LFL 64	04.05 -	HYD-P	MTR-CODE: D 0834 LFL 41; REQ: 2	AVX 13 x 1375 TM
				AC-C	MTR-CODE: D0834LFL41; OE-NO.: 51968200314	4 PK 1380 TM
				AC-C	MTR-CODE: D0834LFL41; OE-NO.: 51968200317	4 PK 1390 TM
				ALT	MTR-CODE: D0834LFL41	8 PK 1275 TM

#### 12.210

4580 ccm	151 kW	D 0834 LFL 42;D 0834 LFL 52;D 0834 LFL 55	04.05 -	HYD-P	MTR-CODE: D 0834 LFL 41; REQ: 2	AVX 13 x 1375 TM
				AC-C	MTR-CODE: D0834LFL41; OE-NO.: 51968200314	4 PK 1380 TM
				AC-C	MTR-CODE: D0834LFL41; OE-NO.: 51968200317	4 PK 1390 TM
				ALT	MTR-CODE: D0834LFL41	8 PK 1275 TM

#### 12.240

6871 ccm	176 kW	D 0836 LFL 40;D 0836 LFL 50;D 0836 LFL 53	04.05 -	HYD-P	MTR-CODE: D 0836 LFL 40; REQ: 2	AVX 13 x 1375 TM
				AC-C	MTR-CODE: D0836LFL40; OE-NO.: 51968200314	4 PK 1380 TM
				AC-C	MTR-CODE: D0836LFL40; OE-NO.: 51968200317	4 PK 1390 TM
				ALT	MTR-CODE: D0836LFL40	8 PK 1275 TM

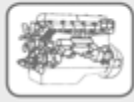

## MAN

### TGL

#### 7.150; 8.150

4580 ccm	110 kW	D 0834 LFL 40;D 0834 LFL 50;D 0834 LFL 53;D 0834 LFL 60;D 0834 LFL 63	04.05 -	HYD-P	MTR-CODE: D 0834 LFL 40; REQ: 2	AVX 13 x 1375 TM
				AC-C	MTR-CODE: D0834LFL40; OE-NO.: 51968200314	4 PK 1380 TM
				AC-C	MTR-CODE: D0834LFL40; OE-NO.: 51968200317	4 PK 1390 TM
				ALT	MTR-CODE: D0834LFL40	8 PK 1275 TM

#### 7.180

4580 ccm	132 kW	D 0834 LFL 41;D 0834 LFL 51;D 0834 LFL 54;D 0834 LFL 61;D 0834 LFL 64	04.05 -	HYD-P	MTR-CODE: D 0834 LFL 40; REQ: 2	AVX 13 x 1375 TM
				AC-C	MTR-CODE: D0834LFL40; OE-NO.: 51968200314	4 PK 1380 TM
				AC-C	MTR-CODE: D0834LFL40; OE-NO.: 51968200317	4 PK 1390 TM
				ALT	MTR-CODE: D0834LFL40	8 PK 1275 TM

#### 8.180

4580 ccm	132 kW	D 0834 LFL 41;D 0834 LFL 51;D 0834 LFL 54;D 0834 LFL 64	04.05 -	HYD-P	MTR-CODE: D 0834 LFL 41; REQ: 2	AVX 13 x 1375 TM
				AC-C	MTR-CODE: D0834LFL41; OE-NO.: 51968200314	4 PK 1380 TM
				AC-C	MTR-CODE: D0834LFL41; OE-NO.: 51968200317	4 PK 1390 TM
				ALT	MTR-CODE: D0834LFL41	8 PK 1275 TM

#### 8.210

4580 ccm	151 kW	D 0834 LFL 42;D 0834 LFL 52;D 0834 LFL 55	04.05 -	HYD-P	MTR-CODE: D 0834 LFL 41; REQ: 2	AVX 13 x 1375 TM
				AC-C	MTR-CODE: D0834LFL41; OE-NO.: 51968200314	4 PK 1380 TM
				AC-C	MTR-CODE: D0834LFL41; OE-NO.: 51968200317	4 PK 1390 TM
				ALT	MTR-CODE: D0834LFL41	8 PK 1275 TM

#### 8.240

6871 ccm	176 kW	D 0836 LFL 40;D 0836 LFL 50;D 0836 LFL 53	04.05 -	HYD-P	MTR-CODE: D 0836 LFL 40; REQ: 2	AVX 13 x 1375 TM
				AC-C	MTR-CODE: D0836LFL40; OE-NO.: 51968200314	4 PK 1380 TM
				AC-C	MTR-CODE: D0836LFL40; OE-NO.: 51968200317	4 PK 1390 TM
				ALT	MTR-CODE: D0836LFL40	8 PK 1275 TM

### ÜL

#### 242

11967 ccm	177 kW	D 2866 UH/240	09.89 - 03.93	FAN	MTR-CODE: D 2866 UH;240; OE-NO.: 06580722262; MOD: ÜL 242; REQ: 2	AVX 13 x 1125 TM
				W-P	MTR-CODE: D 2866 UH;240; MOD: ÜL 242; REQ: 2	AVX 13 x 1250 TM
				W-P	MTR-CODE: D 2866 UH;240; OE-NO.: 06580722272; MOD: ÜL 242; REQ: 2	AVX 13 x 1250 TM

#### 272

9973 ccm	198 kW	D 2865 LUH02;D 2865 LUH05	03.93 -	FAN	MTR-CODE: D 2865 LUH02; OE-NO.: 06580732302; MOD: ÜL 272; REQ: 2	AVX 13 x 1175 TM
				W-P	MTR-CODE: D 2865 LUH02; MOD: ÜL 272; REQ: 2	AVX 13 x 1225 TM
				W-P	MTR-CODE: D 2865 LUH02; OE-NO.: 06580732282; MOD: ÜL 272; REQ: 2	AVX 13 x 1225 TM

#### 292

11967 ccm	213-222 kW	D 2866 TUH 01	09.89 - 03.93	ALT	OE-NO.: 06580722262; MOD: ÜL 292; REQ: 2	AVX 13 x 1125 TM
				W-P	MTR-CODE: D 2866 TUH 01; MOD: ÜL 292; REQ: 2	AVX 13 x 1250 TM
				W-P	MTR-CODE: D 2866 TUH 01; OE-NO.: 06580722272; MOD: ÜL 292; REQ: 2	AVX 13 x 1250 TM

#### 312; 322

9973 ccm	228-235 kW	D 2865 LUH07;D 2865 LUH08	04.92 - 09.96	FAN	MTR-CODE: D 2865 LUH07; OE-NO.: 06580732302; MOD: ÜL 312;ÜL 322; REQ: 2	AVX 13 x 1175 TM
				W-P	MTR-CODE: D 2865 LUH07; MOD: ÜL 312;ÜL 322; REQ: 2	AVX 13 x 1225 TM
				W-P	MTR-CODE: D 2865 LUH07; OE-NO.: 06580732282; MOD: ÜL 312;ÜL 322; REQ: 2	AVX 13 x 1225 TM



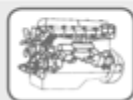

## MAN

### ÜL

#### 313

11967 ccm	228 kW	D 2866 LUH 20;D 2866 LUH26	09.96 -	AC-C	MTR-CODE: D 2866 LUH 20; OE-NO.: 06580732272; MOD: ÜL 313; REQ: 2	AVX 13 x 1150 TM
				ALT	MTR-CODE: D 2866 LUH 20; OE-NO.: 06580732262; MOD: ÜL 313; REQ: 2	AVX 13 x 1125 TM
				FAN	MTR-CODE: D 2866 LUH 20; OE-NO.: 06580732282; MOD: ÜL 313; REQ: 2	AVX 13 x 1175 TM
				W-P	MTR-CODE: D 2866 LUH 20; MOD: ÜL 313; REQ: 2	AVX 13 x 1225 TM
				ALT	MOD: ÜL;ÜL 313; 1 ALT	8 PK 1495 TM

#### 353

11967 ccm	257 kW	D 2866 LUH 21	06.97 -	ALT	OE-NO.: 06580732262; MOD: ÜL 353; REQ: 2	AVX 13 x 1125 TM
				ALT	OE-NO.: 06580732272; MOD: ÜL 353; REQ: 2	AVX 13 x 1150 TM
				ALT	OE-NO.: 06580732282; MOD: ÜL 353; REQ: 2	AVX 13 x 1175 TM
				ALT	OE-NO.: 06580732292; MOD: ÜL 353; REQ: 2	AVX 13 x 1200 TM
				W-P	MOD: ÜL 353; REQ: 2	AVX 13 x 1250 TM

## MERCEDES-BENZ

### ACTROS

#### 1831

11946 ccm	230 kW	OM 541.920	04.96 - 10.02	ALT	FROM: 09.96; OE-NO.: 5419972692; MOD: 1831AK;1831K;SA50516110	11 PK 1890 TM
				ALT	FROM: 09.96; OE-NO.: 5419972692; MOD: 1831AK;1831K;SA50516901	11 PK 1890 TM
				ALT	FROM: 09.96; OE-NO.: 5419972692; MOD: 1831AK;1831K;SA59902001/02	11 PK 1890 TM
				ALT	FROM: 09.96; OE-NO.: 5419972792; MOD: 1831AK;1831K;SA50516111	11 PK 2835 TM
				ALT	FROM: 09.96; OE-NO.: 5419972792; MOD: 1831AK;1831K;SA59902001/02	11 PK 2835 TM
				FAN	FROM: 09.96; OE-NO.: 5419970892; MOD: 1831AK;1831K;SA50516101	9 PK 1888 TM
				FAN	FROM: 09.96; OE-NO.: 5419972592; MOD: 1831AK;1831K;SA50516109	12 PK 1515 TM
				FAN	FROM: 09.96; OE-NO.: 5419973092; MOD: 1831AK;1831K;SA50516115	12 PK 1507 TM
				HYD-P	FROM: 09.96; OE-NO.: 5419972892; MOD: 1831AK;1831K;SA50516110/11	8 PK 1215 TM
				HYD-P	FROM: 09.96; OE-NO.: 5419972892; MOD: 1831AK;1831K;SA50516901	8 PK 1215 TM
				HYD-P	FROM: 09.96; OE-NO.: 5419972892; MOD: 1831AK;1831K;SA59902001/02	8 PK 1215 TM
				W-P	FROM: 09.96; OE-NO.: 5419970992; MOD: 1831AK;1831K;SA50516102	9 PK 2835 TM
				W-P	FROM: 09.96; OE-NO.: 5419971092; MOD: 1831AK;1831K;SA50516103	9 PK 2295 TM
				ALT; AC-C; PS		KT 7004
		OM 541.920;OM 541.940		ALT	FROM: 09.96; OE-NO.: 5419972692; MOD: 1831AK;1831K;SA50516110	11 PK 1890 TM
				ALT	FROM: 09.96; OE-NO.: 5419972692; MOD: 1831AK;1831K;SA50516901	11 PK 1890 TM
				ALT	FROM: 09.96; OE-NO.: 5419972692; MOD: 1831AK;1831K;SA59902001/02	11 PK 1890 TM
				ALT	FROM: 09.96; OE-NO.: 5419972792; MOD: 1831AK;1831K;SA50516111	11 PK 2835 TM
				ALT	FROM: 09.96; OE-NO.: 5419972792; MOD: 1831AK;1831K;SA59902001/02	11 PK 2835 TM
				ALT	OE-NO.: 5419972692; MOD: 1831AK;1831K;SA50516110	11 PK 1890 TM
				ALT	OE-NO.: 5419972692; MOD: 1831AK;1831K;SA50516901	11 PK 1890 TM
				ALT	OE-NO.: 5419972692; MOD: 1831AK;1831K;SA59902001/02	11 PK 1890 TM
				ALT	OE-NO.: 5419972792; MOD: 1831AK;1831K;SA50516111	11 PK 2835 TM
				ALT	OE-NO.: 5419972792; MOD: 1831AK;1831K;SA59902001/02	11 PK 2835 TM
				FAN	FROM: 09.96; OE-NO.: 5419970892; MOD: 1831AK;1831K;SA50516101	9 PK 1888 TM
				FAN	FROM: 09.96; OE-NO.: 5419972592; MOD: 1831AK;1831K;SA50516109	12 PK 1515 TM
				FAN	FROM: 09.96; OE-NO.: 5419973092; MOD: 1831AK;1831K;SA50516115	12 PK 1507 TM

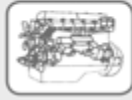

## MERCEDES-BENZ

### ACTROS

#### 1831

11946 ccm	230 kW	OM 541.920;OM 541.940	04.96 - 10.02	FAN	OE-NO.: 5419970892; MOD: 1831AK;1831K;SA50516101	9 PK 1888 TM
				FAN	OE-NO.: 5419972592; MOD: 1831AK;1831K;SA50516109	12 PK 1515 TM
				FAN	OE-NO.: 5419973092; MOD: 1831AK;1831K;SA50516115	12 PK 1507 TM
				HYD-P	FROM: 09.96; OE-NO.: 5419972892; MOD: 1831AK;1831K;SA50516110/11	8 PK 1215 TM
				HYD-P	FROM: 09.96; OE-NO.: 5419972892; MOD: 1831AK;1831K;SA50516901	8 PK 1215 TM
				HYD-P	FROM: 09.96; OE-NO.: 5419972892; MOD: 1831AK;1831K;SA59902001/02	8 PK 1215 TM
				HYD-P	OE-NO.: 5419972892; MOD: 1831AK;1831K;SA50516110/11	8 PK 1215 TM
				HYD-P	OE-NO.: 5419972892; MOD: 1831AK;1831K;SA50516901	8 PK 1215 TM
				HYD-P	OE-NO.: 5419972892; MOD: 1831AK;1831K;SA59902001/02	8 PK 1215 TM
				W-P	FROM: 09.96; OE-NO.: 5419970992; MOD: 1831AK;1831K;SA50516102	9 PK 2835 TM
				W-P	FROM: 09.96; OE-NO.: 5419971092; MOD: 1831AK;1831K;SA50516103	9 PK 2295 TM
				W-P	OE-NO.: 5419970992; MOD: 1831AK;1831K;SA50516102	9 PK 2835 TM
				W-P	OE-NO.: 5419971092; MOD: 1831AK;1831K;SA50516103	9 PK 2295 TM
				ALT; AC-C; PS		KT 7004
		OM 541.926;OM 541.941		ALT	MTR-CODE: OM541.920; OE-NO.: 5419972692; MOD: 1831AK;1831K;SA50516110	11 PK 1890 TM
				ALT	MTR-CODE: OM541.920; OE-NO.: 5419972692; MOD: 1831AK;1831K;SA50516901	11 PK 1890 TM
				ALT	MTR-CODE: OM541.920; OE-NO.: 5419972692; MOD: 1831AK;1831K;SA59902001/02	11 PK 1890 TM
				ALT	MTR-CODE: OM541.920; OE-NO.: 5419972792; MOD: 1831AK;1831K;SA50516111	11 PK 2835 TM
				ALT	MTR-CODE: OM541.920; OE-NO.: 5419972792; MOD: 1831AK;1831K;SA59902001/02	11 PK 2835 TM
				FAN	MTR-CODE: OM541.920; OE-NO.: 5419970892; MOD: 1831AK;1831K;SA50516101	9 PK 1888 TM
				FAN	MTR-CODE: OM541.920; OE-NO.: 5419972592; MOD: 1831AK;1831K;SA50516109	12 PK 1515 TM
				FAN	MTR-CODE: OM541.920; OE-NO.: 5419973092; MOD: 1831AK;1831K;SA50516115	12 PK 1507 TM
				HYD-P	MTR-CODE: OM541.920; OE-NO.: 5419972892; MOD: 1831AK;1831K;SA50516110/11	8 PK 1215 TM
				HYD-P	MTR-CODE: OM541.920; OE-NO.: 5419972892; MOD: 1831AK;1831K;SA50516901	8 PK 1215 TM
				HYD-P	MTR-CODE: OM541.920; OE-NO.: 5419972892; MOD: 1831AK;1831K;SA59902001/02	8 PK 1215 TM
				W-P	MTR-CODE: OM541.920; OE-NO.: 5419970992; MOD: 1831AK;1831K;SA50516102	9 PK 2835 TM
				W-P	MTR-CODE: OM541.920; OE-NO.: 5419971092; MOD: 1831AK;1831K;SA50516103	9 PK 2295 TM

#### 1835

11946 ccm	260 kW	OM 541.922	04.96 - 10.02	ALT	FROM: 09.96; MTR-CODE: OM541.920; OE-NO.: 5419972692; MOD: 1831AK;1831K;SA50516110	11 PK 1890 TM
				ALT	FROM: 09.96; MTR-CODE: OM541.920; OE-NO.: 5419972692; MOD: 1831AK;1831K;SA50516901	11 PK 1890 TM
				ALT	FROM: 09.96; MTR-CODE: OM541.920; OE-NO.: 5419972692; MOD: 1831AK;1831K;SA59902001/02	11 PK 1890 TM
				ALT	FROM: 09.96; MTR-CODE: OM541.920; OE-NO.: 5419972792; MOD: 1831AK;1831K;SA50516111	11 PK 2835 TM
				ALT	FROM: 09.96; MTR-CODE: OM541.920; OE-NO.: 5419972792; MOD: 1831AK;1831K;SA59902001/02	11 PK 2835 TM
				FAN	FROM: 09.96; MTR-CODE: OM541.920; OE-NO.: 5419970892; MOD: 1831AK;1831K;SA50516101	9 PK 1888 TM
				FAN	FROM: 09.96; MTR-CODE: OM541.920; OE-NO.: 5419972592; MOD: 1831AK;1831K;SA50516109	12 PK 1515 TM



## MERCEDES-BENZ

### ACTROS

#### 1835

11946 ccm	260 kW	OM 541.922	04.96 - 10.02	FAN	FROM: 09.96; MTR-CODE: OM541.920; OE-NO.: 5419973092; MOD: 1831AK;1831K;SA50516115	<b>12 PK 1507 TM</b>
				HYD-P	FROM: 09.96; MTR-CODE: OM541.920; OE-NO.: 5419972892; MOD: 1831AK;1831K;SA50516110/11	<b>8 PK 1215 TM</b>
				HYD-P	FROM: 09.96; MTR-CODE: OM541.920; OE-NO.: 5419972892; MOD: 1831AK;1831K;SA50516901	<b>8 PK 1215 TM</b>
				HYD-P	FROM: 09.96; MTR-CODE: OM541.920; OE-NO.: 5419972892; MOD: 1831AK;1831K;SA59902001/02	<b>8 PK 1215 TM</b>
				W-P	FROM: 09.96; MTR-CODE: OM541.920; OE-NO.: 5419970992; MOD: 1831AK;1831K;SA50516102	<b>9 PK 2835 TM</b>
				W-P	FROM: 09.96; MTR-CODE: OM541.920; OE-NO.: 5419971092; MOD: 1831AK;1831K;SA50516103	<b>9 PK 2295 TM</b>
				ALT; AC-C	MTR-CODE: OM 541.920	<b>KT 7004</b>
		OM 541.922;OM 541.942		ALT	FROM: 09.96; MTR-CODE: OM541.920; OE-NO.: 5419972692; MOD: 1831AK;1831K;SA50516110	<b>11 PK 1890 TM</b>
				ALT	FROM: 09.96; MTR-CODE: OM541.920; OE-NO.: 5419972692; MOD: 1831AK;1831K;SA50516901	<b>11 PK 1890 TM</b>
				ALT	FROM: 09.96; MTR-CODE: OM541.920; OE-NO.: 5419972692; MOD: 1831AK;1831K;SA59902001/02	<b>11 PK 1890 TM</b>
				ALT	FROM: 09.96; MTR-CODE: OM541.920; OE-NO.: 5419972792; MOD: 1831AK;1831K;SA50516111	<b>11 PK 2835 TM</b>
				ALT	FROM: 09.96; MTR-CODE: OM541.920; OE-NO.: 5419972792; MOD: 1831AK;1831K;SA59902001/02	<b>11 PK 2835 TM</b>
				ALT	MTR-CODE: OM541.920; OE-NO.: 5419972692; MOD: 1831AK;1831K;SA50516110	<b>11 PK 1890 TM</b>
				ALT	MTR-CODE: OM541.920; OE-NO.: 5419972692; MOD: 1831AK;1831K;SA50516901	<b>11 PK 1890 TM</b>
				ALT	MTR-CODE: OM541.920; OE-NO.: 5419972692; MOD: 1831AK;1831K;SA59902001/02	<b>11 PK 1890 TM</b>
				ALT	MTR-CODE: OM541.920; OE-NO.: 5419972792; MOD: 1831AK;1831K;SA50516111	<b>11 PK 2835 TM</b>
				ALT	MTR-CODE: OM541.920; OE-NO.: 5419972792; MOD: 1831AK;1831K;SA59902001/02	<b>11 PK 2835 TM</b>
				FAN	FROM: 09.96; MTR-CODE: OM541.920; OE-NO.: 5419970892; MOD: 1831AK;1831K;SA50516101	<b>9 PK 1888 TM</b>
				FAN	FROM: 09.96; MTR-CODE: OM541.920; OE-NO.: 5419972592; MOD: 1831AK;1831K;SA50516109	<b>12 PK 1515 TM</b>
				FAN	FROM: 09.96; MTR-CODE: OM541.920; OE-NO.: 5419973092; MOD: 1831AK;1831K;SA50516115	<b>12 PK 1507 TM</b>
				FAN	MTR-CODE: OM541.920; OE-NO.: 5419970892; MOD: 1831AK;1831K;SA50516101	<b>9 PK 1888 TM</b>
				FAN	MTR-CODE: OM541.920; OE-NO.: 5419972592; MOD: 1831AK;1831K;SA50516109	<b>12 PK 1515 TM</b>
				FAN	MTR-CODE: OM541.920; OE-NO.: 5419973092; MOD: 1831AK;1831K;SA50516115	<b>12 PK 1507 TM</b>
				HYD-P	FROM: 09.96; MTR-CODE: OM541.920; OE-NO.: 5419972892; MOD: 1831AK;1831K;SA50516110/11	<b>8 PK 1215 TM</b>
				HYD-P	FROM: 09.96; MTR-CODE: OM541.920; OE-NO.: 5419972892; MOD: 1831AK;1831K;SA50516901	<b>8 PK 1215 TM</b>
				HYD-P	FROM: 09.96; MTR-CODE: OM541.920; OE-NO.: 5419972892; MOD: 1831AK;1831K;SA59902001/02	<b>8 PK 1215 TM</b>
				HYD-P	MTR-CODE: OM541.920; OE-NO.: 5419972892; MOD: 1831AK;1831K;SA50516110/11	<b>8 PK 1215 TM</b>
				HYD-P	MTR-CODE: OM541.920; OE-NO.: 5419972892; MOD: 1831AK;1831K;SA50516901	<b>8 PK 1215 TM</b>
				HYD-P	MTR-CODE: OM541.920; OE-NO.: 5419972892; MOD: 1831AK;1831K;SA59902001/02	<b>8 PK 1215 TM</b>

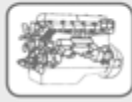

## MERCEDES-BENZ

### ACTROS

#### 1835

11946 ccm	260 kW	OM 541.922;OM 541.942	04.96 - 10.02	W-P	FROM: 09.96; MTR-CODE: OM541.920; OE-NO.: 5419970992; MOD: 1831AK;1831K;SA50516102	<b>9 PK 2835 TM</b>
				W-P	FROM: 09.96; MTR-CODE: OM541.920; OE-NO.: 5419971092; MOD: 1831AK;1831K;SA50516103	<b>9 PK 2295 TM</b>
				W-P	MTR-CODE: OM541.920; OE-NO.: 5419970992; MOD: 1831AK;1831K;SA50516102	<b>9 PK 2835 TM</b>
				W-P	MTR-CODE: OM541.920; OE-NO.: 5419971092; MOD: 1831AK;1831K;SA50516103	<b>9 PK 2295 TM</b>
				ALT; AC-C	MTR-CODE: OM 541.920	<b>KT 7004</b>
		OM 541.927;OM 541.943		ALT	MTR-CODE: OM541.920; OE-NO.: 5419972692; MOD: 1831AK;1831K;SA50516110	<b>11 PK 1890 TM</b>
				ALT	MTR-CODE: OM541.920; OE-NO.: 5419972692; MOD: 1831AK;1831K;SA50516901	<b>11 PK 1890 TM</b>
				ALT	MTR-CODE: OM541.920; OE-NO.: 5419972692; MOD: 1831AK;1831K;SA59902001/02	<b>11 PK 1890 TM</b>
				ALT	MTR-CODE: OM541.920; OE-NO.: 5419972792; MOD: 1831AK;1831K;SA50516111	<b>11 PK 2835 TM</b>
				ALT	MTR-CODE: OM541.920; OE-NO.: 5419972792; MOD: 1831AK;1831K;SA59902001/02	<b>11 PK 2835 TM</b>
				FAN	MTR-CODE: OM541.920; OE-NO.: 5419970892; MOD: 1831AK;1831K;SA50516101	<b>9 PK 1888 TM</b>
				FAN	MTR-CODE: OM541.920; OE-NO.: 5419972592; MOD: 1831AK;1831K;SA50516109	<b>12 PK 1515 TM</b>
				FAN	MTR-CODE: OM541.920; OE-NO.: 5419973092; MOD: 1831AK;1831K;SA50516115	<b>12 PK 1507 TM</b>
				HYD-P	MTR-CODE: OM541.920; OE-NO.: 5419972892; MOD: 1831AK;1831K;SA50516110/11	<b>8 PK 1215 TM</b>
				HYD-P	MTR-CODE: OM541.920; OE-NO.: 5419972892; MOD: 1831AK;1831K;SA50516901	<b>8 PK 1215 TM</b>
				HYD-P	MTR-CODE: OM541.920; OE-NO.: 5419972892; MOD: 1831AK;1831K;SA59902001/02	<b>8 PK 1215 TM</b>
				W-P	MTR-CODE: OM541.920; OE-NO.: 5419970992; MOD: 1831AK;1831K;SA50516102	<b>9 PK 2835 TM</b>
				W-P	MTR-CODE: OM541.920; OE-NO.: 5419971092; MOD: 1831AK;1831K;SA50516103	<b>9 PK 2295 TM</b>
				ALT; AC-C	MTR-CODE: OM 541.920	<b>KT 7004</b>

#### 1840

11946 ccm	290 kW	OM 541.923	04.96 - 10.02	ALT	FROM: 09.96; MTR-CODE: OM541.920; OE-NO.: 5419972692; MOD: 1831AK;1831K;SA50516110	<b>11 PK 1890 TM</b>
				ALT	FROM: 09.96; MTR-CODE: OM541.920; OE-NO.: 5419972692; MOD: 1831AK;1831K;SA50516901	<b>11 PK 1890 TM</b>
				ALT	FROM: 09.96; MTR-CODE: OM541.920; OE-NO.: 5419972692; MOD: 1831AK;1831K;SA59902001/02	<b>11 PK 1890 TM</b>
				ALT	FROM: 09.96; MTR-CODE: OM541.920; OE-NO.: 5419972792; MOD: 1831AK;1831K;SA50516111	<b>11 PK 2835 TM</b>
				ALT	FROM: 09.96; MTR-CODE: OM541.920; OE-NO.: 5419972792; MOD: 1831AK;1831K;SA59902001/02	<b>11 PK 2835 TM</b>
				FAN	FROM: 09.96; MTR-CODE: OM541.920; OE-NO.: 5419970892; MOD: 1831AK;1831K;SA50516101	<b>9 PK 1888 TM</b>
				FAN	FROM: 09.96; MTR-CODE: OM541.920; OE-NO.: 5419972592; MOD: 1831AK;1831K;SA50516109	<b>12 PK 1515 TM</b>
				FAN	FROM: 09.96; MTR-CODE: OM541.920; OE-NO.: 5419973092; MOD: 1831AK;1831K;SA50516115	<b>12 PK 1507 TM</b>
				HYD-P	FROM: 09.96; MTR-CODE: OM541.920; OE-NO.: 5419972892; MOD: 1831AK;1831K;SA50516110/11	<b>8 PK 1215 TM</b>
				HYD-P	FROM: 09.96; MTR-CODE: OM541.920; OE-NO.: 5419972892; MOD: 1831AK;1831K;SA50516901	<b>8 PK 1215 TM</b>
				HYD-P	FROM: 09.96; MTR-CODE: OM541.920; OE-NO.: 5419972892; MOD: 1831AK;1831K;SA59902001/02	<b>8 PK 1215 TM</b>
				W-P	FROM: 09.96; MTR-CODE: OM541.920; OE-NO.: 5419970992; MOD: 1831AK;1831K;SA50516102	<b>9 PK 2835 TM</b>

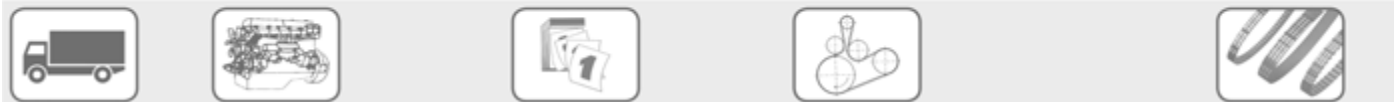

## MERCEDES-BENZ

### ACTROS

#### 1840

11946 ccm	290 kW	OM 541.923	04.96 - 10.02	W-P	FROM: 09.96; MTR-CODE: OM541.920; OE-NO.: 5419971092; MOD: 1831AK;1831K;SA50516103	<b>9 PK 2295 TM</b>
				ALT; AC-C	MTR-CODE: OM 541.920	<b>KT 7004</b>
		OM 541.923;OM 541.944		ALT	FROM: 09.96; MTR-CODE: OM541.920; OE-NO.: 5419972692; MOD: 1831AK;1831K;SA50516110	<b>11 PK 1890 TM</b>
				ALT	FROM: 09.96; MTR-CODE: OM541.920; OE-NO.: 5419972692; MOD: 1831AK;1831K;SA50516901	<b>11 PK 1890 TM</b>
				ALT	FROM: 09.96; MTR-CODE: OM541.920; OE-NO.: 5419972692; MOD: 1831AK;1831K;SA59902001/02	<b>11 PK 1890 TM</b>
				ALT	FROM: 09.96; MTR-CODE: OM541.920; OE-NO.: 5419972792; MOD: 1831AK;1831K;SA50516111	<b>11 PK 2835 TM</b>
				ALT	FROM: 09.96; MTR-CODE: OM541.920; OE-NO.: 5419972792; MOD: 1831AK;1831K;SA59902001/02	<b>11 PK 2835 TM</b>
				ALT	MTR-CODE: OM541.920; OE-NO.: 5419972692; MOD: 1831AK;1831K;SA50516110	<b>11 PK 1890 TM</b>
				ALT	MTR-CODE: OM541.920; OE-NO.: 5419972692; MOD: 1831AK;1831K;SA50516901	<b>11 PK 1890 TM</b>
				ALT	MTR-CODE: OM541.920; OE-NO.: 5419972692; MOD: 1831AK;1831K;SA59902001/02	<b>11 PK 1890 TM</b>
				ALT	MTR-CODE: OM541.920; OE-NO.: 5419972792; MOD: 1831AK;1831K;SA50516111	<b>11 PK 2835 TM</b>
				ALT	MTR-CODE: OM541.920; OE-NO.: 5419972792; MOD: 1831AK;1831K;SA59902001/02	<b>11 PK 2835 TM</b>
				FAN	FROM: 09.96; MTR-CODE: OM541.920; OE-NO.: 5419970892; MOD: 1831AK;1831K;SA50516101	<b>9 PK 1888 TM</b>
				FAN	FROM: 09.96; MTR-CODE: OM541.920; OE-NO.: 5419972592; MOD: 1831AK;1831K;SA50516109	<b>12 PK 1515 TM</b>
				FAN	FROM: 09.96; MTR-CODE: OM541.920; OE-NO.: 5419973092; MOD: 1831AK;1831K;SA50516115	<b>12 PK 1507 TM</b>
				FAN	MTR-CODE: OM541.920; OE-NO.: 5419970892; MOD: 1831AK;1831K;SA50516101	<b>9 PK 1888 TM</b>
				FAN	MTR-CODE: OM541.920; OE-NO.: 5419972592; MOD: 1831AK;1831K;SA50516109	<b>12 PK 1515 TM</b>
				FAN	MTR-CODE: OM541.920; OE-NO.: 5419973092; MOD: 1831AK;1831K;SA50516115	<b>12 PK 1507 TM</b>
				HYD-P	FROM: 09.96; MTR-CODE: OM541.920; OE-NO.: 5419972892; MOD: 1831AK;1831K;SA50516110/11	<b>8 PK 1215 TM</b>
				HYD-P	FROM: 09.96; MTR-CODE: OM541.920; OE-NO.: 5419972892; MOD: 1831AK;1831K;SA50516901	<b>8 PK 1215 TM</b>
				HYD-P	FROM: 09.96; MTR-CODE: OM541.920; OE-NO.: 5419972892; MOD: 1831AK;1831K;SA59902001/02	<b>8 PK 1215 TM</b>
				HYD-P	MTR-CODE: OM541.920; OE-NO.: 5419972892; MOD: 1831AK;1831K;SA50516110/11	<b>8 PK 1215 TM</b>
				HYD-P	MTR-CODE: OM541.920; OE-NO.: 5419972892; MOD: 1831AK;1831K;SA50516901	<b>8 PK 1215 TM</b>
				HYD-P	MTR-CODE: OM541.920; OE-NO.: 5419972892; MOD: 1831AK;1831K;SA59902001/02	<b>8 PK 1215 TM</b>
				W-P	FROM: 09.96; MTR-CODE: OM541.920; OE-NO.: 5419970992; MOD: 1831AK;1831K;SA50516102	<b>9 PK 2835 TM</b>
				W-P	FROM: 09.96; MTR-CODE: OM541.920; OE-NO.: 5419971092; MOD: 1831AK;1831K;SA50516103	<b>9 PK 2295 TM</b>
				W-P	MTR-CODE: OM541.920; OE-NO.: 5419970992; MOD: 1831AK;1831K;SA50516102	<b>9 PK 2835 TM</b>
				W-P	MTR-CODE: OM541.920; OE-NO.: 5419971092; MOD: 1831AK;1831K;SA50516103	<b>9 PK 2295 TM</b>
				ALT; AC-C	MTR-CODE: OM 541.920	<b>KT 7004</b>
		OM 541.924;OM 541.945		ALT	MTR-CODE: OM541.920; OE-NO.: 5419972692; MOD: 1831AK;1831K;SA50516110	<b>11 PK 1890 TM</b>
				ALT	MTR-CODE: OM541.920; OE-NO.: 5419972692; MOD: 1831AK;1831K;SA50516901	<b>11 PK 1890 TM</b>
				ALT	MTR-CODE: OM541.920; OE-NO.: 5419972692; MOD: 1831AK;1831K;SA59902001/02	<b>11 PK 1890 TM</b>



## MERCEDES-BENZ

### ACTROS

#### 1840

11946 ccm	290 kW	OM 541.924;OM 541.945	04.96 - 10.02	ALT	MTR-CODE: OM541.920; OE-NO.: 5419972792; MOD: 1831AK;1831K;SA50516111	<b>11 PK 2835 TM</b>
				ALT	MTR-CODE: OM541.920; OE-NO.: 5419972792; MOD: 1831AK;1831K;SA59902001/02	<b>11 PK 2835 TM</b>
				FAN	MTR-CODE: OM541.920; OE-NO.: 5419970892; MOD: 1831AK;1831K;SA50516101	<b>9 PK 1888 TM</b>
				FAN	MTR-CODE: OM541.920; OE-NO.: 5419972592; MOD: 1831AK;1831K;SA50516109	<b>12 PK 1515 TM</b>
				FAN	MTR-CODE: OM541.920; OE-NO.: 5419973092; MOD: 1831AK;1831K;SA50516115	<b>12 PK 1507 TM</b>
				HYD-P	MTR-CODE: OM541.920; OE-NO.: 5419972892; MOD: 1831AK;1831K;SA50516110/11	<b>8 PK 1215 TM</b>
				HYD-P	MTR-CODE: OM541.920; OE-NO.: 5419972892; MOD: 1831AK;1831K;SA50516901	<b>8 PK 1215 TM</b>
				HYD-P	MTR-CODE: OM541.920; OE-NO.: 5419972892; MOD: 1831AK;1831K;SA59902001/02	<b>8 PK 1215 TM</b>
				W-P	MTR-CODE: OM541.920; OE-NO.: 5419970992; MOD: 1831AK;1831K;SA50516102	<b>9 PK 2835 TM</b>
				W-P	MTR-CODE: OM541.920; OE-NO.: 5419971092; MOD: 1831AK;1831K;SA50516103	<b>9 PK 2295 TM</b>
				ALT; AC-C	MTR-CODE: OM 541.920	<b>KT 7004</b>

#### 1843

11946 ccm	315 kW	OM 541.921;OM 541.947	04.96 - 10.02	ALT	MTR-CODE: OM541.920; OE-NO.: 5419972692; MOD: 1831AK;1831K;SA50516110	<b>11 PK 1890 TM</b>
				ALT	MTR-CODE: OM541.920; OE-NO.: 5419972692; MOD: 1831AK;1831K;SA50516901	<b>11 PK 1890 TM</b>
				ALT	MTR-CODE: OM541.920; OE-NO.: 5419972692; MOD: 1831AK;1831K;SA59902001/02	<b>11 PK 1890 TM</b>
				ALT	MTR-CODE: OM541.920; OE-NO.: 5419972792; MOD: 1831AK;1831K;SA50516111	<b>11 PK 2835 TM</b>
				ALT	MTR-CODE: OM541.920; OE-NO.: 5419972792; MOD: 1831AK;1831K;SA59902001/02	<b>11 PK 2835 TM</b>
				FAN	MTR-CODE: OM541.920; OE-NO.: 5419970892; MOD: 1831AK;1831K;SA50516101	<b>9 PK 1888 TM</b>
				FAN	MTR-CODE: OM541.920; OE-NO.: 5419972592; MOD: 1831AK;1831K;SA50516109	<b>12 PK 1515 TM</b>
				FAN	MTR-CODE: OM541.920; OE-NO.: 5419973092; MOD: 1831AK;1831K;SA50516115	<b>12 PK 1507 TM</b>
				HYD-P	MTR-CODE: OM541.920; OE-NO.: 5419972892; MOD: 1831AK;1831K;SA50516110/11	<b>8 PK 1215 TM</b>
				HYD-P	MTR-CODE: OM541.920; OE-NO.: 5419972892; MOD: 1831AK;1831K;SA50516901	<b>8 PK 1215 TM</b>
				HYD-P	MTR-CODE: OM541.920; OE-NO.: 5419972892; MOD: 1831AK;1831K;SA59902001/02	<b>8 PK 1215 TM</b>
				W-P	MTR-CODE: OM541.920; OE-NO.: 5419970992; MOD: 1831AK;1831K;SA50516102	<b>9 PK 2835 TM</b>
				W-P	MTR-CODE: OM541.920; OE-NO.: 5419971092; MOD: 1831AK;1831K;SA50516103	<b>9 PK 2295 TM</b>
				ALT; AC-C	MTR-CODE: OM 541.920	<b>KT 7004</b>
		OM 541.925		ALT	FROM: 09.96; MTR-CODE: OM541.920; OE-NO.: 5419972692; MOD: 1831AK;1831K;SA50516110	<b>11 PK 1890 TM</b>
				ALT	FROM: 09.96; MTR-CODE: OM541.920; OE-NO.: 5419972692; MOD: 1831AK;1831K;SA50516901	<b>11 PK 1890 TM</b>
				ALT	FROM: 09.96; MTR-CODE: OM541.920; OE-NO.: 5419972692; MOD: 1831AK;1831K;SA59902001/02	<b>11 PK 1890 TM</b>
				ALT	FROM: 09.96; MTR-CODE: OM541.920; OE-NO.: 5419972792; MOD: 1831AK;1831K;SA50516111	<b>11 PK 2835 TM</b>
				ALT	FROM: 09.96; MTR-CODE: OM541.920; OE-NO.: 5419972792; MOD: 1831AK;1831K;SA59902001/02	<b>11 PK 2835 TM</b>
				FAN	FROM: 09.96; MTR-CODE: OM541.920; OE-NO.: 5419970892; MOD: 1831AK;1831K;SA50516101	<b>9 PK 1888 TM</b>
				FAN	FROM: 09.96; MTR-CODE: OM541.920; OE-NO.: 5419972592; MOD: 1831AK;1831K;SA50516109	<b>12 PK 1515 TM</b>
				FAN	FROM: 09.96; MTR-CODE: OM541.920; OE-NO.: 5419973092; MOD: 1831AK;1831K;SA50516115	<b>12 PK 1507 TM</b>

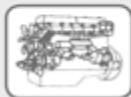

## MERCEDES-BENZ

### ACTROS

1843

11946 ccm	315 kW	OM 541.925	04.96 - 10.02	HYD-P	FROM: 09.96; MTR-CODE: OM541.920; OE-NO.: 5419972892; MOD: 1831AK;1831K;SA50516110/11	8 PK 1215 TM
				HYD-P	FROM: 09.96; MTR-CODE: OM541.920; OE-NO.: 5419972892; MOD: 1831AK;1831K;SA50516901	8 PK 1215 TM
				HYD-P	FROM: 09.96; MTR-CODE: OM541.920; OE-NO.: 5419972892; MOD: 1831AK;1831K;SA59902001/02	8 PK 1215 TM
				W-P	FROM: 09.96; MTR-CODE: OM541.920; OE-NO.: 5419970992; MOD: 1831AK;1831K;SA50516102	9 PK 2835 TM
				W-P	FROM: 09.96; MTR-CODE: OM541.920; OE-NO.: 5419971092; MOD: 1831AK;1831K;SA50516103	9 PK 2295 TM
				ALT; AC-C	MTR-CODE: OM 541.920	KT 7004
		OM 541.925;OM 541.946		ALT	FROM: 09.96; MTR-CODE: OM541.920; OE-NO.: 5419972692; MOD: 1831AK;1831K;SA50516110	11 PK 1890 TM
				ALT	FROM: 09.96; MTR-CODE: OM541.920; OE-NO.: 5419972692; MOD: 1831AK;1831K;SA50516901	11 PK 1890 TM
				ALT	FROM: 09.96; MTR-CODE: OM541.920; OE-NO.: 5419972692; MOD: 1831AK;1831K;SA59902001/02	11 PK 1890 TM
				ALT	FROM: 09.96; MTR-CODE: OM541.920; OE-NO.: 5419972792; MOD: 1831AK;1831K;SA50516111	11 PK 2835 TM
				ALT	FROM: 09.96; MTR-CODE: OM541.920; OE-NO.: 5419972792; MOD: 1831AK;1831K;SA59902001/02	11 PK 2835 TM
				ALT	MTR-CODE: OM541.920; OE-NO.: 5419972692; MOD: 1831AK;1831K;SA50516110	11 PK 1890 TM
				ALT	MTR-CODE: OM541.920; OE-NO.: 5419972692; MOD: 1831AK;1831K;SA50516901	11 PK 1890 TM
				ALT	MTR-CODE: OM541.920; OE-NO.: 5419972692; MOD: 1831AK;1831K;SA59902001/02	11 PK 1890 TM
				ALT	MTR-CODE: OM541.920; OE-NO.: 5419972792; MOD: 1831AK;1831K;SA50516111	11 PK 2835 TM
				ALT	MTR-CODE: OM541.920; OE-NO.: 5419972792; MOD: 1831AK;1831K;SA59902001/02	11 PK 2835 TM
				FAN	FROM: 09.96; MTR-CODE: OM541.920; OE-NO.: 5419970892; MOD: 1831AK;1831K;SA50516101	9 PK 1888 TM
				FAN	FROM: 09.96; MTR-CODE: OM541.920; OE-NO.: 5419972592; MOD: 1831AK;1831K;SA50516109	12 PK 1515 TM
				FAN	FROM: 09.96; MTR-CODE: OM541.920; OE-NO.: 5419973092; MOD: 1831AK;1831K;SA50516115	12 PK 1507 TM
				FAN	MTR-CODE: OM541.920; OE-NO.: 5419970892; MOD: 1831AK;1831K;SA50516101	9 PK 1888 TM
				FAN	MTR-CODE: OM541.920; OE-NO.: 5419972592; MOD: 1831AK;1831K;SA50516109	12 PK 1515 TM
				FAN	MTR-CODE: OM541.920; OE-NO.: 5419973092; MOD: 1831AK;1831K;SA50516115	12 PK 1507 TM
				HYD-P	FROM: 09.96; MTR-CODE: OM541.920; OE-NO.: 5419972892; MOD: 1831AK;1831K;SA50516110/11	8 PK 1215 TM
				HYD-P	FROM: 09.96; MTR-CODE: OM541.920; OE-NO.: 5419972892; MOD: 1831AK;1831K;SA50516901	8 PK 1215 TM
				HYD-P	FROM: 09.96; MTR-CODE: OM541.920; OE-NO.: 5419972892; MOD: 1831AK;1831K;SA59902001/02	8 PK 1215 TM
				HYD-P	MTR-CODE: OM541.920; OE-NO.: 5419972892; MOD: 1831AK;1831K;SA50516110/11	8 PK 1215 TM
				HYD-P	MTR-CODE: OM541.920; OE-NO.: 5419972892; MOD: 1831AK;1831K;SA50516901	8 PK 1215 TM
				HYD-P	MTR-CODE: OM541.920; OE-NO.: 5419972892; MOD: 1831AK;1831K;SA59902001/02	8 PK 1215 TM
				W-P	FROM: 09.96; MTR-CODE: OM541.920; OE-NO.: 5419970992; MOD: 1831AK;1831K;SA50516102	9 PK 2835 TM



## MERCEDES-BENZ

### ACTROS

#### 1843

11946 ccm	315 kW	OM 541.925;OM 541.946	04.96 - 10.02	W-P	FROM: 09.96; MTR-CODE: OM541.920; OE-NO.: 5419971092; MOD: 1831AK;1831K;SA50516103	9 PK 2295 TM
				W-P	MTR-CODE: OM541.920; OE-NO.: 5419970992; MOD: 1831AK;1831K;SA50516102	9 PK 2835 TM
				W-P	MTR-CODE: OM541.920; OE-NO.: 5419971092; MOD: 1831AK;1831K;SA50516103	9 PK 2295 TM
				ALT; AC-C	MTR-CODE: OM 541.920	KT 7004

#### 1848

15928 ccm	350 kW	OM 542.921	04.96 - 10.02	ALT	FROM: 09.96; MTR-CODE: OM542.920; OE-NO.: 5419972692; MOD: 1848AK;1848K;SA50516110	11 PK 1890 TM
				ALT	FROM: 09.96; MTR-CODE: OM542.920; OE-NO.: 5419972692; MOD: 1848AK;1848K;SA50516901	11 PK 1890 TM
				ALT	FROM: 09.96; MTR-CODE: OM542.920; OE-NO.: 5419972692; MOD: 1848AK;1848K;SA59902001/02	11 PK 1890 TM
				ALT	FROM: 09.96; MTR-CODE: OM542.920; OE-NO.: 5419972792; MOD: 1848AK;1848K;SA50516111	11 PK 2835 TM
				ALT	FROM: 09.96; MTR-CODE: OM542.920; OE-NO.: 5419972792; MOD: 1848AK;1848K;SA59902001/02	11 PK 2835 TM
				FAN	FROM: 09.96; MTR-CODE: OM542.920; OE-NO.: 5419970892; MOD: 1848AK;1848K;SA50516101	9 PK 1888 TM
				FAN	FROM: 09.96; MTR-CODE: OM542.920; OE-NO.: 5419972592; MOD: 1848AK;1848K;SA50516109	12 PK 1515 TM
				FAN	FROM: 09.96; MTR-CODE: OM542.920; OE-NO.: 5419973092; MOD: 1848AK;1848K;SA50516115	12 PK 1507 TM
				HYD-P	FROM: 09.96; MTR-CODE: OM542.920; OE-NO.: 5419972892; MOD: 1848AK;1848K;SA50516110/11	8 PK 1215 TM
				HYD-P	FROM: 09.96; MTR-CODE: OM542.920; OE-NO.: 5419972892; MOD: 1848AK;1848K;SA50516901	8 PK 1215 TM
				HYD-P	FROM: 09.96; MTR-CODE: OM542.920; OE-NO.: 5419972892; MOD: 1848AK;1848K;SA59902001/02	8 PK 1215 TM
				W-P	FROM: 09.96; MTR-CODE: OM542.920; OE-NO.: 5419970992; MOD: 1848AK;1848K;SA50516102	9 PK 2835 TM
				W-P	FROM: 09.96; MTR-CODE: OM542.920; OE-NO.: 5419971092; MOD: 1848AK;1848K;SA50516103	9 PK 2295 TM
				ALT; AC-C	MTR-CODE: OM 542.920	KT 7004
		OM 542.921;OM 542.940		ALT	FROM: 09.96; MTR-CODE: OM542.920; OE-NO.: 5419972692; MOD: 1848AK;1848K;SA50516110	11 PK 1890 TM
				ALT	FROM: 09.96; MTR-CODE: OM542.920; OE-NO.: 5419972692; MOD: 1848AK;1848K;SA50516901	11 PK 1890 TM
				ALT	FROM: 09.96; MTR-CODE: OM542.920; OE-NO.: 5419972692; MOD: 1848AK;1848K;SA59902001/02	11 PK 1890 TM
				ALT	FROM: 09.96; MTR-CODE: OM542.920; OE-NO.: 5419972792; MOD: 1848AK;1848K;SA50516111	11 PK 2835 TM
				ALT	FROM: 09.96; MTR-CODE: OM542.920; OE-NO.: 5419972792; MOD: 1848AK;1848K;SA59902001/02	11 PK 2835 TM
				ALT	MTR-CODE: OM542.920; OE-NO.: 5419972692; MOD: 1848AK;1848K;SA50516110	11 PK 1890 TM
				ALT	MTR-CODE: OM542.920; OE-NO.: 5419972692; MOD: 1848AK;1848K;SA50516901	11 PK 1890 TM
				ALT	MTR-CODE: OM542.920; OE-NO.: 5419972692; MOD: 1848AK;1848K;SA59902001/02	11 PK 1890 TM
				ALT	MTR-CODE: OM542.920; OE-NO.: 5419972792; MOD: 1848AK;1848K;SA50516111	11 PK 2835 TM
				ALT	MTR-CODE: OM542.920; OE-NO.: 5419972792; MOD: 1848AK;1848K;SA59902001/02	11 PK 2835 TM



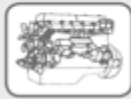

## MERCEDES-BENZ

### ACTROS

#### 1848

15928 ccm	350 kW	OM 542.921;OM 542.940	04.96 - 10.02	FAN	FROM: 09.96; MTR-CODE: OM542.920; OE-NO.: 5419970892; MOD: 1848AK;1848K;SA50516101	9 PK 1888 TM
				FAN	FROM: 09.96; MTR-CODE: OM542.920; OE-NO.: 5419972592; MOD: 1848AK;1848K;SA50516109	12 PK 1515 TM
				FAN	FROM: 09.96; MTR-CODE: OM542.920; OE-NO.: 5419973092; MOD: 1848AK;1848K;SA50516115	12 PK 1507 TM
				FAN	MTR-CODE: OM542.920; OE-NO.: 5419970892; MOD: 1848AK;1848K;SA50516101	9 PK 1888 TM
				FAN	MTR-CODE: OM542.920; OE-NO.: 5419972592; MOD: 1848AK;1848K;SA50516109	12 PK 1515 TM
				FAN	MTR-CODE: OM542.920; OE-NO.: 5419973092; MOD: 1848AK;1848K;SA50516115	12 PK 1507 TM
				HYD-P	FROM: 09.96; MTR-CODE: OM542.920; OE-NO.: 5419972892; MOD: 1848AK;1848K;SA50516110/11	8 PK 1215 TM
				HYD-P	FROM: 09.96; MTR-CODE: OM542.920; OE-NO.: 5419972892; MOD: 1848AK;1848K;SA50516901	8 PK 1215 TM
				HYD-P	FROM: 09.96; MTR-CODE: OM542.920; OE-NO.: 5419972892; MOD: 1848AK;1848K;SA59902001/02	8 PK 1215 TM
				HYD-P	MTR-CODE: OM542.920; OE-NO.: 5419972892; MOD: 1848AK;1848K;SA50516110/11	8 PK 1215 TM
				HYD-P	MTR-CODE: OM542.920; OE-NO.: 5419972892; MOD: 1848AK;1848K;SA50516901	8 PK 1215 TM
				HYD-P	MTR-CODE: OM542.920; OE-NO.: 5419972892; MOD: 1848AK;1848K;SA59902001/02	8 PK 1215 TM
				W-P	FROM: 09.96; MTR-CODE: OM542.920; OE-NO.: 5419970992; MOD: 1848AK;1848K;SA50516102	9 PK 2835 TM
				W-P	FROM: 09.96; MTR-CODE: OM542.920; OE-NO.: 5419971092; MOD: 1848AK;1848K;SA50516103	9 PK 2295 TM
				W-P	MTR-CODE: OM542.920; OE-NO.: 5419970992; MOD: 1848AK;1848K;SA50516102	9 PK 2835 TM
				W-P	MTR-CODE: OM542.920; OE-NO.: 5419971092; MOD: 1848AK;1848K;SA50516103	9 PK 2295 TM
				ALT; AC-C	MTR-CODE: OM 542.920	KT 7004
		OM 542.925		ALT	MTR-CODE: OM542.920; OE-NO.: 5419972692; MOD: 1848AK;1848K;SA50516110	11 PK 1890 TM
				ALT	MTR-CODE: OM542.920; OE-NO.: 5419972692; MOD: 1848AK;1848K;SA50516901	11 PK 1890 TM
				ALT	MTR-CODE: OM542.920; OE-NO.: 5419972692; MOD: 1848AK;1848K;SA59902001/02	11 PK 1890 TM
				ALT	MTR-CODE: OM542.920; OE-NO.: 5419972792; MOD: 1848AK;1848K;SA50516111	11 PK 2835 TM
				ALT	MTR-CODE: OM542.920; OE-NO.: 5419972792; MOD: 1848AK;1848K;SA59902001/02	11 PK 2835 TM
				FAN	MTR-CODE: OM542.920; OE-NO.: 5419970892; MOD: 1848AK;1848K;SA50516101	9 PK 1888 TM
				FAN	MTR-CODE: OM542.920; OE-NO.: 5419972592; MOD: 1848AK;1848K;SA50516109	12 PK 1515 TM
				FAN	MTR-CODE: OM542.920; OE-NO.: 5419973092; MOD: 1848AK;1848K;SA50516115	12 PK 1507 TM
				HYD-P	MTR-CODE: OM542.920; OE-NO.: 5419972892; MOD: 1848AK;1848K;SA50516110/11	8 PK 1215 TM
				HYD-P	MTR-CODE: OM542.920; OE-NO.: 5419972892; MOD: 1848AK;1848K;SA50516901	8 PK 1215 TM
				HYD-P	MTR-CODE: OM542.920; OE-NO.: 5419972892; MOD: 1848AK;1848K;SA59902001/02	8 PK 1215 TM
				W-P	MTR-CODE: OM542.920; OE-NO.: 5419970992; MOD: 1848AK;1848K;SA50516102	9 PK 2835 TM
				W-P	MTR-CODE: OM542.920; OE-NO.: 5419971092; MOD: 1848AK;1848K;SA50516103	9 PK 2295 TM
				ALT; AC-C	MTR-CODE: OM 542.920	KT 7004

#### 1853

15928 ccm	390 kW	OM 542.920	04.96 - 10.02	ALT	FROM: 09.96; OE-NO.: 5419972692; MOD: 1848AK;1848K;SA50516110	11 PK 1890 TM
				ALT	FROM: 09.96; OE-NO.: 5419972692; MOD: 1848AK;1848K;SA50516901	11 PK 1890 TM
				ALT	FROM: 09.96; OE-NO.: 5419972692; MOD: 1848AK;1848K;SA59902001/02	11 PK 1890 TM



## MERCEDES-BENZ

### ACTROS

#### 1853

15928 ccm	390 kW	OM 542.920	04.96 - 10.02	ALT	FROM: 09.96; OE-NO.: 5419972792; MOD: 1848AK;1848K;SA50516111	11 PK 2835 TM
				ALT	FROM: 09.96; OE-NO.: 5419972792; MOD: 1848AK;1848K;SA59902001/02	11 PK 2835 TM
				FAN	FROM: 09.96; OE-NO.: 5419970892; MOD: 1848AK;1848K;SA50516101	9 PK 1888 TM
				FAN	FROM: 09.96; OE-NO.: 5419972592; MOD: 1848AK;1848K;SA50516109	12 PK 1515 TM
				FAN	FROM: 09.96; OE-NO.: 5419973092; MOD: 1848AK;1848K;SA50516115	12 PK 1507 TM
				HYD-P	FROM: 09.96; OE-NO.: 5419972892; MOD: 1848AK;1848K;SA50516110/11	8 PK 1215 TM
				HYD-P	FROM: 09.96; OE-NO.: 5419972892; MOD: 1848AK;1848K;SA50516901	8 PK 1215 TM
				HYD-P	FROM: 09.96; OE-NO.: 5419972892; MOD: 1848AK;1848K;SA59902001/02	8 PK 1215 TM
				W-P	FROM: 09.96; OE-NO.: 5419970992; MOD: 1848AK;1848K;SA50516102	9 PK 2835 TM
				W-P	FROM: 09.96; OE-NO.: 5419971092; MOD: 1848AK;1848K;SA50516103	9 PK 2295 TM
				ALT; AC-C; PS		KT 7004
	OM 542.920;OM 542.942			ALT	FROM: 09.96; OE-NO.: 5419972692; MOD: 1848AK;1848K;SA50516110	11 PK 1890 TM
				ALT	FROM: 09.96; OE-NO.: 5419972692; MOD: 1848AK;1848K;SA50516901	11 PK 1890 TM
				ALT	FROM: 09.96; OE-NO.: 5419972692; MOD: 1848AK;1848K;SA59902001/02	11 PK 1890 TM
				ALT	FROM: 09.96; OE-NO.: 5419972792; MOD: 1848AK;1848K;SA50516111	11 PK 2835 TM
				ALT	FROM: 09.96; OE-NO.: 5419972792; MOD: 1848AK;1848K;SA59902001/02	11 PK 2835 TM
				FAN	FROM: 09.96; OE-NO.: 5419970892; MOD: 1848AK;1848K;SA50516101	9 PK 1888 TM
				FAN	FROM: 09.96; OE-NO.: 5419972592; MOD: 1848AK;1848K;SA50516109	12 PK 1515 TM
				FAN	FROM: 09.96; OE-NO.: 5419973092; MOD: 1848AK;1848K;SA50516115	12 PK 1507 TM
				HYD-P	FROM: 09.96; OE-NO.: 5419972892; MOD: 1848AK;1848K;SA50516110/11	8 PK 1215 TM
				HYD-P	FROM: 09.96; OE-NO.: 5419972892; MOD: 1848AK;1848K;SA50516901	8 PK 1215 TM
				HYD-P	FROM: 09.96; OE-NO.: 5419972892; MOD: 1848AK;1848K;SA59902001/02	8 PK 1215 TM
				W-P	FROM: 09.96; OE-NO.: 5419970992; MOD: 1848AK;1848K;SA50516102	9 PK 2835 TM
				W-P	FROM: 09.96; OE-NO.: 5419971092; MOD: 1848AK;1848K;SA50516103	9 PK 2295 TM
				ALT; AC-C; PS		KT 7004

#### 1857

15928 ccm	420 kW	OM 542.922	04.97 - 10.02	ALT	MTR-CODE: OM542.920; OE-NO.: 5419972692; MOD: 1848AK;1848K;SA50516110	11 PK 1890 TM
				ALT	MTR-CODE: OM542.920; OE-NO.: 5419972692; MOD: 1848AK;1848K;SA50516901	11 PK 1890 TM
				ALT	MTR-CODE: OM542.920; OE-NO.: 5419972692; MOD: 1848AK;1848K;SA59902001/02	11 PK 1890 TM
				ALT	MTR-CODE: OM542.920; OE-NO.: 5419972792; MOD: 1848AK;1848K;SA50516111	11 PK 2835 TM
				ALT	MTR-CODE: OM542.920; OE-NO.: 5419972792; MOD: 1848AK;1848K;SA59902001/02	11 PK 2835 TM
				FAN	MTR-CODE: OM542.920; OE-NO.: 5419970892; MOD: 1848AK;1848K;SA50516101	9 PK 1888 TM
				FAN	MTR-CODE: OM542.920; OE-NO.: 5419972592; MOD: 1848AK;1848K;SA50516109	12 PK 1515 TM
				FAN	MTR-CODE: OM542.920; OE-NO.: 5419973092; MOD: 1848AK;1848K;SA50516115	12 PK 1507 TM
				HYD-P	MTR-CODE: OM542.920; OE-NO.: 5419972892; MOD: 1848AK;1848K;SA50516110/11	8 PK 1215 TM
				HYD-P	MTR-CODE: OM542.920; OE-NO.: 5419972892; MOD: 1848AK;1848K;SA50516901	8 PK 1215 TM
				HYD-P	MTR-CODE: OM542.920; OE-NO.: 5419972892; MOD: 1848AK;1848K;SA59902001/02	8 PK 1215 TM
				W-P	MTR-CODE: OM542.920; OE-NO.: 5419970992; MOD: 1848AK;1848K;SA50516102	9 PK 2835 TM



## MERCEDES-BENZ

### ACTROS

#### 1857

15928 ccm	420 kW	OM 542.922	04.97 - 10.02	W-P	MTR-CODE: OM542.920; OE-NO.: 5419971092; MOD: 1848AK;1848K;SA50516103	<b>9 PK 2295 TM</b>
				ALT; AC-C	MTR-CODE: OM 542.920	<b>KT 7004</b>
		OM 542.922;OM 542.944		ALT	MTR-CODE: OM542.920; OE-NO.: 5419972692; MOD: 1848AK;1848K;SA50516110	<b>11 PK 1890 TM</b>
				ALT	MTR-CODE: OM542.920; OE-NO.: 5419972692; MOD: 1848AK;1848K;SA50516901	<b>11 PK 1890 TM</b>
				ALT	MTR-CODE: OM542.920; OE-NO.: 5419972692; MOD: 1848AK;1848K;SA59902001/02	<b>11 PK 1890 TM</b>
				ALT	MTR-CODE: OM542.920; OE-NO.: 5419972792; MOD: 1848AK;1848K;SA50516111	<b>11 PK 2835 TM</b>
				ALT	MTR-CODE: OM542.920; OE-NO.: 5419972792; MOD: 1848AK;1848K;SA59902001/02	<b>11 PK 2835 TM</b>
				FAN	MTR-CODE: OM542.920; OE-NO.: 5419970892; MOD: 1848AK;1848K;SA50516101	<b>9 PK 1888 TM</b>
				FAN	MTR-CODE: OM542.920; OE-NO.: 5419972592; MOD: 1848AK;1848K;SA50516109	<b>12 PK 1515 TM</b>
				FAN	MTR-CODE: OM542.920; OE-NO.: 5419973092; MOD: 1848AK;1848K;SA50516115	<b>12 PK 1507 TM</b>
				HYD-P	MTR-CODE: OM542.920; OE-NO.: 5419972892; MOD: 1848AK;1848K;SA50516110/11	<b>8 PK 1215 TM</b>
				HYD-P	MTR-CODE: OM542.920; OE-NO.: 5419972892; MOD: 1848AK;1848K;SA50516901	<b>8 PK 1215 TM</b>
				HYD-P	MTR-CODE: OM542.920; OE-NO.: 5419972892; MOD: 1848AK;1848K;SA59902001/02	<b>8 PK 1215 TM</b>
				W-P	MTR-CODE: OM542.920; OE-NO.: 5419970992; MOD: 1848AK;1848K;SA50516102	<b>9 PK 2835 TM</b>
				W-P	MTR-CODE: OM542.920; OE-NO.: 5419971092; MOD: 1848AK;1848K;SA50516103	<b>9 PK 2295 TM</b>
				ALT; AC-C	MTR-CODE: OM 542.920	<b>KT 7004</b>

#### 2031

11946 ccm	230 kW	OM 541.920	04.96 - 10.02	ALT	OE-NO.: 5419972692; MOD: 2031;2031A;2031AK;SA50516110	<b>11 PK 1890 TM</b>
				ALT	OE-NO.: 5419972692; MOD: 2031;2031A;2031AK;SA50516901	<b>11 PK 1890 TM</b>
				ALT	OE-NO.: 5419972692; MOD: 2031;2031A;2031AK;SA59902001/02	<b>11 PK 1890 TM</b>
				ALT	OE-NO.: 5419972792; MOD: 2031;2031A;2031AK;SA50516111	<b>11 PK 2835 TM</b>
				ALT	OE-NO.: 5419972792; MOD: 2031;2031A;2031AK;SA59902001/02	<b>11 PK 2835 TM</b>
				FAN	OE-NO.: 5419970892; MOD: 2031;2031A;2031AK;SA50516101	<b>9 PK 1888 TM</b>
				FAN	OE-NO.: 5419972592; MOD: 2031;2031A;2031AK;SA50516109	<b>12 PK 1515 TM</b>
				FAN	OE-NO.: 5419973092; MOD: 2031;2031A;2031AK;SA50516115	<b>12 PK 1507 TM</b>
				HYD-P	OE-NO.: 5419972892; MOD: 2031;2031A;2031AK;SA50516110/11	<b>8 PK 1215 TM</b>
				HYD-P	OE-NO.: 5419972892; MOD: 2031;2031A;2031AK;SA50516901	<b>8 PK 1215 TM</b>
				HYD-P	OE-NO.: 5419972892; MOD: 2031;2031A;2031AK;SA59902001/02	<b>8 PK 1215 TM</b>
				W-P	OE-NO.: 5419970992; MOD: 2031;2031A;2031AK;SA50516102	<b>9 PK 2835 TM</b>
				W-P	OE-NO.: 5419971092; MOD: 2031;2031A;2031AK;SA50516103	<b>9 PK 2295 TM</b>
				ALT; AC-C; PS		<b>KT 7004</b>
		OM 541.920;OM 541.940		ALT	OE-NO.: 5419972692; MOD: 2031;2031A;2031AK;SA50516110	<b>11 PK 1890 TM</b>
				ALT	OE-NO.: 5419972692; MOD: 2031;2031A;2031AK;SA50516901	<b>11 PK 1890 TM</b>
				ALT	OE-NO.: 5419972692; MOD: 2031;2031A;2031AK;SA59902001/02	<b>11 PK 1890 TM</b>
				ALT	OE-NO.: 5419972792; MOD: 2031;2031A;2031AK;SA50516111	<b>11 PK 2835 TM</b>
				ALT	OE-NO.: 5419972792; MOD: 2031;2031A;2031AK;SA59902001/02	<b>11 PK 2835 TM</b>
				FAN	OE-NO.: 5419970892; MOD: 2031;2031A;2031AK;SA50516101	<b>9 PK 1888 TM</b>
				FAN	OE-NO.: 5419972592; MOD: 2031;2031A;2031AK;SA50516109	<b>12 PK 1515 TM</b>
				FAN	OE-NO.: 5419973092; MOD: 2031;2031A;2031AK;SA50516115	<b>12 PK 1507 TM</b>

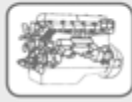

## MERCEDES-BENZ

### ACTROS

#### 2031

11946 ccm	230 kW	OM 541.920;OM 541.940	04.96 - 10.02	HYD-P	OE-NO.: 5419972892; MOD: 2031;2031A;2031AK;SA50516110/11	8 PK 1215 TM
				HYD-P	OE-NO.: 5419972892; MOD: 2031;2031A;2031AK;SA50516901	8 PK 1215 TM
				HYD-P	OE-NO.: 5419972892; MOD: 2031;2031A;2031AK;SA59902001/02	8 PK 1215 TM
				W-P	OE-NO.: 5419970992; MOD: 2031;2031A;2031AK;SA50516102	9 PK 2835 TM
				W-P	OE-NO.: 5419971092; MOD: 2031;2031A;2031AK;SA50516103	9 PK 2295 TM
				ALT; AC-C; PS		KT 7004
		OM 541.926		ALT	MTR-CODE: OM541.920; OE-NO.: 5419972692; MOD: 2031;2031A;2031AK;SA50516110	11 PK 1890 TM
				ALT	MTR-CODE: OM541.920; OE-NO.: 5419972692; MOD: 2031;2031A;2031AK;SA50516901	11 PK 1890 TM
				ALT	MTR-CODE: OM541.920; OE-NO.: 5419972692; MOD: 2031;2031A;2031AK;SA59902001/02	11 PK 1890 TM
				ALT	MTR-CODE: OM541.920; OE-NO.: 5419972792; MOD: 2031;2031A;2031AK;SA50516111	11 PK 2835 TM
				ALT	MTR-CODE: OM541.920; OE-NO.: 5419972792; MOD: 2031;2031A;2031AK;SA59902001/02	11 PK 2835 TM
				FAN	MTR-CODE: OM541.920; OE-NO.: 5419970892; MOD: 2031;2031A;2031AK;SA50516101	9 PK 1888 TM
				FAN	MTR-CODE: OM541.920; OE-NO.: 5419972592; MOD: 2031;2031A;2031AK;SA50516109	12 PK 1515 TM
				FAN	MTR-CODE: OM541.920; OE-NO.: 5419973092; MOD: 2031;2031A;2031AK;SA50516115	12 PK 1507 TM
				HYD-P	MTR-CODE: OM541.920; OE-NO.: 5419972892; MOD: 2031;2031A;2031AK;SA50516110/11	8 PK 1215 TM
				HYD-P	MTR-CODE: OM541.920; OE-NO.: 5419972892; MOD: 2031;2031A;2031AK;SA50516901	8 PK 1215 TM
				HYD-P	MTR-CODE: OM541.920; OE-NO.: 5419972892; MOD: 2031;2031A;2031AK;SA59902001/02	8 PK 1215 TM
				W-P	MTR-CODE: OM541.920; OE-NO.: 5419970992; MOD: 2031;2031A;2031AK;SA50516102	9 PK 2835 TM
				W-P	MTR-CODE: OM541.920; OE-NO.: 5419971092; MOD: 2031;2031A;2031AK;SA50516103	9 PK 2295 TM
		OM 541.926;OM 541.941		ALT	MTR-CODE: OM541.920; OE-NO.: 5419972692; MOD: 2031;2031A;2031AK;SA50516110	11 PK 1890 TM
				ALT	MTR-CODE: OM541.920; OE-NO.: 5419972692; MOD: 2031;2031A;2031AK;SA50516901	11 PK 1890 TM
				ALT	MTR-CODE: OM541.920; OE-NO.: 5419972692; MOD: 2031;2031A;2031AK;SA59902001/02	11 PK 1890 TM
				ALT	MTR-CODE: OM541.920; OE-NO.: 5419972792; MOD: 2031;2031A;2031AK;SA50516111	11 PK 2835 TM
				ALT	MTR-CODE: OM541.920; OE-NO.: 5419972792; MOD: 2031;2031A;2031AK;SA59902001/02	11 PK 2835 TM
				FAN	MTR-CODE: OM541.920; OE-NO.: 5419970892; MOD: 2031;2031A;2031AK;SA50516101	9 PK 1888 TM
				FAN	MTR-CODE: OM541.920; OE-NO.: 5419972592; MOD: 2031;2031A;2031AK;SA50516109	12 PK 1515 TM
				FAN	MTR-CODE: OM541.920; OE-NO.: 5419973092; MOD: 2031;2031A;2031AK;SA50516115	12 PK 1507 TM
				HYD-P	MTR-CODE: OM541.920; OE-NO.: 5419972892; MOD: 2031;2031A;2031AK;SA50516110/11	8 PK 1215 TM
				HYD-P	MTR-CODE: OM541.920; OE-NO.: 5419972892; MOD: 2031;2031A;2031AK;SA50516901	8 PK 1215 TM
				HYD-P	MTR-CODE: OM541.920; OE-NO.: 5419972892; MOD: 2031;2031A;2031AK;SA59902001/02	8 PK 1215 TM
				W-P	MTR-CODE: OM541.920; OE-NO.: 5419970992; MOD: 2031;2031A;2031AK;SA50516102	9 PK 2835 TM
				W-P	MTR-CODE: OM541.920; OE-NO.: 5419971092; MOD: 2031;2031A;2031AK;SA50516103	9 PK 2295 TM

#### 2035

11946 ccm	260 kW	OM 541.927;OM 541.943	04.96 - 10.02	ALT	MTR-CODE: OM541.920; OE-NO.: 5419972692; MOD: 2031;2031A;2031AK;SA50516110	11 PK 1890 TM
				ALT	MTR-CODE: OM541.920; OE-NO.: 5419972692; MOD: 2031;2031A;2031AK;SA50516901	11 PK 1890 TM
				ALT	MTR-CODE: OM541.920; OE-NO.: 5419972692; MOD: 2031;2031A;2031AK;SA59902001/02	11 PK 1890 TM
				ALT	MTR-CODE: OM541.920; OE-NO.: 5419972792; MOD: 2031;2031A;2031AK;SA50516111	11 PK 2835 TM
				ALT	MTR-CODE: OM541.920; OE-NO.: 5419972792; MOD: 2031;2031A;2031AK;SA59902001/02	11 PK 2835 TM



## MERCEDES-BENZ

### ACTROS

#### 2035

11946 ccm	260 kW	OM 541.927;OM 541.943	04.96 - 10.02	FAN	MTR-CODE: OM541.920; OE-NO.: 5419970892; MOD: 2031;2031A;2031AK;SA50516101	9 PK 1888 TM
				FAN	MTR-CODE: OM541.920; OE-NO.: 5419972592; MOD: 2031;2031A;2031AK;SA50516109	12 PK 1515 TM
				FAN	MTR-CODE: OM541.920; OE-NO.: 5419973092; MOD: 2031;2031A;2031AK;SA50516115	12 PK 1507 TM
				HYD-P	MTR-CODE: OM541.920; OE-NO.: 5419972892; MOD: 2031;2031A;2031AK;SA50516110/11	8 PK 1215 TM
				HYD-P	MTR-CODE: OM541.920; OE-NO.: 5419972892; MOD: 2031;2031A;2031AK;SA50516901	8 PK 1215 TM
				HYD-P	MTR-CODE: OM541.920; OE-NO.: 5419972892; MOD: 2031;2031A;2031AK;SA59902001/02	8 PK 1215 TM
				W-P	MTR-CODE: OM541.920; OE-NO.: 5419970992; MOD: 2031;2031A;2031AK;SA50516102	9 PK 2835 TM
				W-P	MTR-CODE: OM541.920; OE-NO.: 5419971092; MOD: 2031;2031A;2031AK;SA50516103	9 PK 2295 TM
				ALT; AC-C	MTR-CODE: OM 541.920	KT 7004

#### 2040

11946 ccm	290 kW	OM 541.923	04.96 - 10.02	ALT	MTR-CODE: OM541.920; OE-NO.: 5419972692; MOD: 2031;2031A;2031AK;SA50516110	11 PK 1890 TM
				ALT	MTR-CODE: OM541.920; OE-NO.: 5419972692; MOD: 2031;2031A;2031AK;SA50516901	11 PK 1890 TM
				ALT	MTR-CODE: OM541.920; OE-NO.: 5419972692; MOD: 2031;2031A;2031AK;SA59902001/02	11 PK 1890 TM
				ALT	MTR-CODE: OM541.920; OE-NO.: 5419972792; MOD: 2031;2031A;2031AK;SA50516111	11 PK 2835 TM
				ALT	MTR-CODE: OM541.920; OE-NO.: 5419972792; MOD: 2031;2031A;2031AK;SA59902001/02	11 PK 2835 TM
				FAN	MTR-CODE: OM541.920; OE-NO.: 5419970892; MOD: 2031;2031A;2031AK;SA50516101	9 PK 1888 TM
				FAN	MTR-CODE: OM541.920; OE-NO.: 5419972592; MOD: 2031;2031A;2031AK;SA50516109	12 PK 1515 TM
				FAN	MTR-CODE: OM541.920; OE-NO.: 5419973092; MOD: 2031;2031A;2031AK;SA50516115	12 PK 1507 TM
				HYD-P	MTR-CODE: OM541.920; OE-NO.: 5419972892; MOD: 2031;2031A;2031AK;SA50516110/11	8 PK 1215 TM
				HYD-P	MTR-CODE: OM541.920; OE-NO.: 5419972892; MOD: 2031;2031A;2031AK;SA50516901	8 PK 1215 TM
				HYD-P	MTR-CODE: OM541.920; OE-NO.: 5419972892; MOD: 2031;2031A;2031AK;SA59902001/02	8 PK 1215 TM
				W-P	MTR-CODE: OM541.920; OE-NO.: 5419970992; MOD: 2031;2031A;2031AK;SA50516102	9 PK 2835 TM
				W-P	MTR-CODE: OM541.920; OE-NO.: 5419971092; MOD: 2031;2031A;2031AK;SA50516103	9 PK 2295 TM
				ALT; AC-C	MTR-CODE: OM 541.920	KT 7004
		OM 541.923;OM 541.944		ALT	MTR-CODE: OM541.920; OE-NO.: 5419972692; MOD: 2031;2031A;2031AK;SA50516110	11 PK 1890 TM
				ALT	MTR-CODE: OM541.920; OE-NO.: 5419972692; MOD: 2031;2031A;2031AK;SA50516901	11 PK 1890 TM
				ALT	MTR-CODE: OM541.920; OE-NO.: 5419972692; MOD: 2031;2031A;2031AK;SA59902001/02	11 PK 1890 TM
				ALT	MTR-CODE: OM541.920; OE-NO.: 5419972792; MOD: 2031;2031A;2031AK;SA50516111	11 PK 2835 TM
				ALT	MTR-CODE: OM541.920; OE-NO.: 5419972792; MOD: 2031;2031A;2031AK;SA59902001/02	11 PK 2835 TM
				FAN	MTR-CODE: OM541.920; OE-NO.: 5419970892; MOD: 2031;2031A;2031AK;SA50516101	9 PK 1888 TM
				FAN	MTR-CODE: OM541.920; OE-NO.: 5419972592; MOD: 2031;2031A;2031AK;SA50516109	12 PK 1515 TM
				FAN	MTR-CODE: OM541.920; OE-NO.: 5419973092; MOD: 2031;2031A;2031AK;SA50516115	12 PK 1507 TM
				HYD-P	MTR-CODE: OM541.920; OE-NO.: 5419972892; MOD: 2031;2031A;2031AK;SA50516110/11	8 PK 1215 TM
				HYD-P	MTR-CODE: OM541.920; OE-NO.: 5419972892; MOD: 2031;2031A;2031AK;SA50516901	8 PK 1215 TM
				HYD-P	MTR-CODE: OM541.920; OE-NO.: 5419972892; MOD: 2031;2031A;2031AK;SA59902001/02	8 PK 1215 TM
				W-P	MTR-CODE: OM541.920; OE-NO.: 5419970992; MOD: 2031;2031A;2031AK;SA50516102	9 PK 2835 TM
				W-P	MTR-CODE: OM541.920; OE-NO.: 5419971092; MOD: 2031;2031A;2031AK;SA50516103	9 PK 2295 TM
				ALT; AC-C	MTR-CODE: OM 541.920	KT 7004
		OM 541.924;OM 541.945		ALT	MTR-CODE: OM541.920; OE-NO.: 5419972692; MOD: 2031;2031A;2031AK;SA50516110	11 PK 1890 TM



## MERCEDES-BENZ

### ACTROS

#### 2040

11946 ccm	290 kW	OM 541.924;OM 541.945	04.96 - 10.02	ALT	MTR-CODE: OM541.920; OE-NO.: 5419972692; MOD: 2031;2031A;2031AK;SA50516901	11 PK 1890 TM
				ALT	MTR-CODE: OM541.920; OE-NO.: 5419972692; MOD: 2031;2031A;2031AK;SA59902001/02	11 PK 1890 TM
				ALT	MTR-CODE: OM541.920; OE-NO.: 5419972792; MOD: 2031;2031A;2031AK;SA50516111	11 PK 2835 TM
				ALT	MTR-CODE: OM541.920; OE-NO.: 5419972792; MOD: 2031;2031A;2031AK;SA59902001/02	11 PK 2835 TM
				FAN	MTR-CODE: OM541.920; OE-NO.: 5419970892; MOD: 2031;2031A;2031AK;SA50516101	9 PK 1888 TM
				FAN	MTR-CODE: OM541.920; OE-NO.: 5419972592; MOD: 2031;2031A;2031AK;SA50516109	12 PK 1515 TM
				FAN	MTR-CODE: OM541.920; OE-NO.: 5419973092; MOD: 2031;2031A;2031AK;SA50516115	12 PK 1507 TM
				HYD-P	MTR-CODE: OM541.920; OE-NO.: 5419972892; MOD: 2031;2031A;2031AK;SA50516110/11	8 PK 1215 TM
				HYD-P	MTR-CODE: OM541.920; OE-NO.: 5419972892; MOD: 2031;2031A;2031AK;SA50516901	8 PK 1215 TM
				HYD-P	MTR-CODE: OM541.920; OE-NO.: 5419972892; MOD: 2031;2031A;2031AK;SA59902001/02	8 PK 1215 TM
				W-P	MTR-CODE: OM541.920; OE-NO.: 5419970992; MOD: 2031;2031A;2031AK;SA50516102	9 PK 2835 TM
				W-P	MTR-CODE: OM541.920; OE-NO.: 5419971092; MOD: 2031;2031A;2031AK;SA50516103	9 PK 2295 TM
				ALT; AC-C	MTR-CODE: OM 541.920	KT 7004

#### 2043

11946 ccm	315 kW	OM 541.921;OM 541.925;OM 541.947	04.96 - 10.02	ALT; AC-C	MTR-CODE: OM 541.920	KT 7004
-----------	--------	----------------------------------	---------------	-----------	----------------------	---------

#### 2048

15928 ccm	350 kW	OM 542.925	04.96 - 10.02	ALT; AC-C	MTR-CODE: OM 542.920	KT 7004
-----------	--------	------------	---------------	-----------	----------------------	---------

#### 2053

15928 ccm	390 kW	OM 542.920;OM 542.942	04.96 - 10.02	ALT	OE-NO.: 5419972692; MOD: 2053S;SA50516110	11 PK 1890 TM
				ALT	OE-NO.: 5419972692; MOD: 2053S;SA50516901	11 PK 1890 TM
				ALT	OE-NO.: 5419972692; MOD: 2053S;SA59902001/02	11 PK 1890 TM
				ALT	OE-NO.: 5419972792; MOD: 2053S;SA50516111	11 PK 2835 TM
				ALT	OE-NO.: 5419972792; MOD: 2053S;SA59902001/02	11 PK 2835 TM
				FAN	OE-NO.: 5419970892; MOD: 2053S;SA50516101	9 PK 1888 TM
				FAN	OE-NO.: 5419972592; MOD: 2053S;SA50516109	12 PK 1515 TM
				FAN	OE-NO.: 5419973092; MOD: 2053S;SA50516115	12 PK 1507 TM
				HYD-P	OE-NO.: 5419972892; MOD: 2053S;SA50516110/11	8 PK 1215 TM
				HYD-P	OE-NO.: 5419972892; MOD: 2053S;SA50516901	8 PK 1215 TM
				HYD-P	OE-NO.: 5419972892; MOD: 2053S;SA59902001/02	8 PK 1215 TM
				W-P	OE-NO.: 5419970992; MOD: 2053S;SA50516102	9 PK 2835 TM
				W-P	OE-NO.: 5419971092; MOD: 2053S;SA50516103	9 PK 2295 TM
				ALT; AC-C; PS		KT 7004

#### 2531

11946 ccm	230 kW	OM 541.920;OM 541.940	09.96 - 10.02	ALT	MTR-CODE: OM541.920; OE-NO.: 5419972692; MOD: 2531LS;2531,2531L;SA50516110	11 PK 1890 TM
				ALT	MTR-CODE: OM541.920; OE-NO.: 5419972692; MOD: 2531LS;2531,2531L;SA50516901	11 PK 1890 TM
				ALT	MTR-CODE: OM541.920; OE-NO.: 5419972692; MOD: 2531LS;2531,2531L;SA59902001/02	11 PK 1890 TM
				ALT	MTR-CODE: OM541.920; OE-NO.: 5419972792; MOD: 2531LS;2531,2531L;SA50516111	11 PK 2835 TM
				ALT	MTR-CODE: OM541.920; OE-NO.: 5419972792; MOD: 2531LS;2531,2531L;SA59902001/02	11 PK 2835 TM
				ALT	OE-NO.: 5419972692; MOD: 2531LS;2531,2531L;SA50516110	11 PK 1890 TM
				ALT	OE-NO.: 5419972692; MOD: 2531LS;2531,2531L;SA50516901	11 PK 1890 TM
				ALT	OE-NO.: 5419972692; MOD: 2531LS;2531,2531L;SA59902001/02	11 PK 1890 TM
				ALT	OE-NO.: 5419972792; MOD: 2531LS;2531,2531L;SA50516111	11 PK 2835 TM
				ALT	OE-NO.: 5419972792; MOD: 2531LS;2531,2531L;SA59902001/02	11 PK 2835 TM
				FAN	MTR-CODE: OM541.920; OE-NO.: 5419970892; MOD: 2531LS;2531,2531L;SA50516101	9 PK 1888 TM

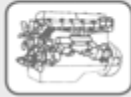

## MERCEDES-BENZ

### ACTROS

#### 2531

11946 ccm	230 kW	OM 541.920;OM 541.940	09.96 - 10.02	FAN	MTR-CODE: OM541.920; OE-NO.: 5419972592; MOD: 2531LS;2531,2531L;SA50516109	12 PK 1515 TM
				FAN	MTR-CODE: OM541.920; OE-NO.: 5419973092; MOD: 2531LS;2531,2531L;SA50516115	12 PK 1507 TM
				FAN	OE-NO.: 5419970892; MOD: 2531LS;2531,2531L;SA50516101	9 PK 1888 TM
				FAN	OE-NO.: 5419972592; MOD: 2531LS;2531,2531L;SA50516109	12 PK 1515 TM
				FAN	OE-NO.: 5419973092; MOD: 2531LS;2531,2531L;SA50516115	12 PK 1507 TM
				HYD-P	MTR-CODE: OM541.920; OE-NO.: 5419972892; MOD: 2531LS;2531,2531L;SA50516110/11	8 PK 1215 TM
				HYD-P	MTR-CODE: OM541.920; OE-NO.: 5419972892; MOD: 2531LS;2531,2531L;SA50516901	8 PK 1215 TM
				HYD-P	MTR-CODE: OM541.920; OE-NO.: 5419972892; MOD: 2531LS;2531,2531L;SA59902001/02	8 PK 1215 TM
				HYD-P	OE-NO.: 5419972892; MOD: 2531LS;2531,2531L;SA50516110/11	8 PK 1215 TM
				HYD-P	OE-NO.: 5419972892; MOD: 2531LS;2531,2531L;SA50516901	8 PK 1215 TM
				HYD-P	OE-NO.: 5419972892; MOD: 2531LS;2531,2531L;SA59902001/02	8 PK 1215 TM
				W-P	MTR-CODE: OM541.920; OE-NO.: 5419970992; MOD: 2531LS;2531,2531L;SA50516102	9 PK 2835 TM
				W-P	MTR-CODE: OM541.920; OE-NO.: 5419971092; MOD: 2531LS;2531,2531L;SA50516103	9 PK 2295 TM
				W-P	OE-NO.: 5419970992; MOD: 2531LS;2531,2531L;SA50516102	9 PK 2835 TM
				W-P	OE-NO.: 5419971092; MOD: 2531LS;2531,2531L;SA50516103	9 PK 2295 TM
				ALT; AC-C	MTR-CODE: OM 541.920	KT 7004
				ALT; AC-C; PS		KT 7004

#### 2535

11946 ccm	260 kW	OM 541.922;OM 541.942	09.96 - 10.02	ALT	MTR-CODE: OM541.920; OE-NO.: 5419972692; MOD: 2531LS;2531,2531L;SA50516110	11 PK 1890 TM
				ALT	MTR-CODE: OM541.920; OE-NO.: 5419972692; MOD: 2531LS;2531,2531L;SA50516901	11 PK 1890 TM
				ALT	MTR-CODE: OM541.920; OE-NO.: 5419972692; MOD: 2531LS;2531,2531L;SA59902001/02	11 PK 1890 TM
				ALT	MTR-CODE: OM541.920; OE-NO.: 5419972792; MOD: 2531LS;2531,2531L;SA50516111	11 PK 2835 TM
				ALT	MTR-CODE: OM541.920; OE-NO.: 5419972792; MOD: 2531LS;2531,2531L;SA59902001/02	11 PK 2835 TM
				FAN	MTR-CODE: OM541.920; OE-NO.: 5419970892; MOD: 2531LS;2531,2531L;SA50516101	9 PK 1888 TM
				FAN	MTR-CODE: OM541.920; OE-NO.: 5419972592; MOD: 2531LS;2531,2531L;SA50516109	12 PK 1515 TM
				FAN	MTR-CODE: OM541.920; OE-NO.: 5419973092; MOD: 2531LS;2531,2531L;SA50516115	12 PK 1507 TM
				HYD-P	MTR-CODE: OM541.920; OE-NO.: 5419972892; MOD: 2531LS;2531,2531L;SA50516110/11	8 PK 1215 TM
				HYD-P	MTR-CODE: OM541.920; OE-NO.: 5419972892; MOD: 2531LS;2531,2531L;SA50516901	8 PK 1215 TM
				HYD-P	MTR-CODE: OM541.920; OE-NO.: 5419972892; MOD: 2531LS;2531,2531L;SA59902001/02	8 PK 1215 TM
				W-P	MTR-CODE: OM541.920; OE-NO.: 5419970992; MOD: 2531LS;2531,2531L;SA50516102	9 PK 2835 TM
				W-P	MTR-CODE: OM541.920; OE-NO.: 5419971092; MOD: 2531LS;2531,2531L;SA50516103	9 PK 2295 TM
				ALT; AC-C	MTR-CODE: OM 541.920	KT 7004

#### 2540

11946 ccm	290 kW	OM 541.923;OM 541.944	09.96 - 10.02	ALT	MTR-CODE: OM541.920; OE-NO.: 5419972692; MOD: 2531LS;2531,2531L;SA50516110	11 PK 1890 TM
				ALT	MTR-CODE: OM541.920; OE-NO.: 5419972692; MOD: 2531LS;2531,2531L;SA50516901	11 PK 1890 TM
				ALT	MTR-CODE: OM541.920; OE-NO.: 5419972692; MOD: 2531LS;2531,2531L;SA59902001/02	11 PK 1890 TM
				ALT	MTR-CODE: OM541.920; OE-NO.: 5419972792; MOD: 2531LS;2531,2531L;SA50516111	11 PK 2835 TM
				ALT	MTR-CODE: OM541.920; OE-NO.: 5419972792; MOD: 2531LS;2531,2531L;SA59902001/02	11 PK 2835 TM
				FAN	MTR-CODE: OM541.920; OE-NO.: 5419970892; MOD: 2531LS;2531,2531L;SA50516101	9 PK 1888 TM



## MERCEDES-BENZ

### ACTROS

#### 2540

11946 ccm	290 kW	OM 541.923;OM 541.944	09.96 - 10.02	FAN	MTR-CODE: OM541.920; OE-NO.: 5419972592; MOD: 2531LS;2531,2531L;SA50516109	<b>12 PK 1515 TM</b>
				FAN	MTR-CODE: OM541.920; OE-NO.: 5419973092; MOD: 2531LS;2531,2531L;SA50516115	<b>12 PK 1507 TM</b>
				HYD-P	MTR-CODE: OM541.920; OE-NO.: 5419972892; MOD: 2531LS;2531,2531L;SA50516110/11	<b>8 PK 1215 TM</b>
				HYD-P	MTR-CODE: OM541.920; OE-NO.: 5419972892; MOD: 2531LS;2531,2531L;SA50516901	<b>8 PK 1215 TM</b>
				HYD-P	MTR-CODE: OM541.920; OE-NO.: 5419972892; MOD: 2531LS;2531,2531L;SA59902001/02	<b>8 PK 1215 TM</b>
				W-P	MTR-CODE: OM541.920; OE-NO.: 5419970992; MOD: 2531LS;2531,2531L;SA50516102	<b>9 PK 2835 TM</b>
				W-P	MTR-CODE: OM541.920; OE-NO.: 5419971092; MOD: 2531LS;2531,2531L;SA50516103	<b>9 PK 2295 TM</b>
				ALT; AC-C	MTR-CODE: OM 541.920	<b>KT 7004</b>

#### 2543

11946 ccm	315 kW	OM 541.925;OM 541.946	09.96 - 10.02	ALT	MTR-CODE: OM541.920; OE-NO.: 5419972692; MOD: 2531LS;2531,2531L;SA50516110	<b>11 PK 1890 TM</b>
				ALT	MTR-CODE: OM541.920; OE-NO.: 5419972692; MOD: 2531LS;2531,2531L;SA50516901	<b>11 PK 1890 TM</b>
				ALT	MTR-CODE: OM541.920; OE-NO.: 5419972692; MOD: 2531LS;2531,2531L;SA59902001/02	<b>11 PK 1890 TM</b>
				ALT	MTR-CODE: OM541.920; OE-NO.: 5419972792; MOD: 2531LS;2531,2531L;SA50516111	<b>11 PK 2835 TM</b>
				ALT	MTR-CODE: OM541.920; OE-NO.: 5419972792; MOD: 2531LS;2531,2531L;SA59902001/02	<b>11 PK 2835 TM</b>
				FAN	MTR-CODE: OM541.920; OE-NO.: 5419970892; MOD: 2531LS;2531,2531L;SA50516101	<b>9 PK 1888 TM</b>
				FAN	MTR-CODE: OM541.920; OE-NO.: 5419972592; MOD: 2531LS;2531,2531L;SA50516109	<b>12 PK 1515 TM</b>
				FAN	MTR-CODE: OM541.920; OE-NO.: 5419973092; MOD: 2531LS;2531,2531L;SA50516115	<b>12 PK 1507 TM</b>
				HYD-P	MTR-CODE: OM541.920; OE-NO.: 5419972892; MOD: 2531LS;2531,2531L;SA50516110/11	<b>8 PK 1215 TM</b>
				HYD-P	MTR-CODE: OM541.920; OE-NO.: 5419972892; MOD: 2531LS;2531,2531L;SA50516901	<b>8 PK 1215 TM</b>
				HYD-P	MTR-CODE: OM541.920; OE-NO.: 5419972892; MOD: 2531LS;2531,2531L;SA59902001/02	<b>8 PK 1215 TM</b>
				W-P	MTR-CODE: OM541.920; OE-NO.: 5419970992; MOD: 2531LS;2531,2531L;SA50516102	<b>9 PK 2835 TM</b>
				W-P	MTR-CODE: OM541.920; OE-NO.: 5419971092; MOD: 2531LS;2531,2531L;SA50516103	<b>9 PK 2295 TM</b>
				ALT; AC-C	MTR-CODE: OM 541.920	<b>KT 7004</b>

#### 2548

15928 ccm	350 kW	OM 542.921	09.96 - 10.02	ALT	MTR-CODE: OM542.920; OE-NO.: 5419972692; MOD: 2548LS;2548,2548L;SA50516110	<b>11 PK 1890 TM</b>
				ALT	MTR-CODE: OM542.920; OE-NO.: 5419972692; MOD: 2548LS;2548,2548L;SA50516901	<b>11 PK 1890 TM</b>
				ALT	MTR-CODE: OM542.920; OE-NO.: 5419972692; MOD: 2548LS;2548,2548L;SA59902001/02	<b>11 PK 1890 TM</b>
				ALT	MTR-CODE: OM542.920; OE-NO.: 5419972792; MOD: 2548LS;2548,2548L;SA50516111	<b>11 PK 2835 TM</b>
				ALT	MTR-CODE: OM542.920; OE-NO.: 5419972792; MOD: 2548LS;2548,2548L;SA59902001/02	<b>11 PK 2835 TM</b>
				FAN	MTR-CODE: OM542.920; OE-NO.: 5419970892; MOD: 2548LS;2548,2548L;SA50516101	<b>9 PK 1888 TM</b>
				FAN	MTR-CODE: OM542.920; OE-NO.: 5419972592; MOD: 2548LS;2548,2548L;SA50516109	<b>12 PK 1515 TM</b>
				FAN	MTR-CODE: OM542.920; OE-NO.: 5419973092; MOD: 2548LS;2548,2548L;SA50516115	<b>12 PK 1507 TM</b>
				HYD-P	MTR-CODE: OM542.920; OE-NO.: 5419972892; MOD: 2548LS;2548,2548L;SA50516110/11	<b>8 PK 1215 TM</b>
				HYD-P	MTR-CODE: OM542.920; OE-NO.: 5419972892; MOD: 2548LS;2548,2548L;SA50516901	<b>8 PK 1215 TM</b>
				HYD-P	MTR-CODE: OM542.920; OE-NO.: 5419972892; MOD: 2548LS;2548,2548L;SA59902001/02	<b>8 PK 1215 TM</b>
				W-P	MTR-CODE: OM542.920; OE-NO.: 5419970992; MOD: 2548LS;2548,2548L;SA50516102	<b>9 PK 2835 TM</b>
				W-P	MTR-CODE: OM542.920; OE-NO.: 5419971092; MOD: 2548LS;2548,2548L;SA50516103	<b>9 PK 2295 TM</b>
				ALT; AC-C	MTR-CODE: OM 542.920	<b>KT 7004</b>
		OM 542.921;OM 542.940		ALT	MTR-CODE: OM542.920; OE-NO.: 5419972692; MOD: 2548LS;2548,2548L;SA50516110	<b>11 PK 1890 TM</b>



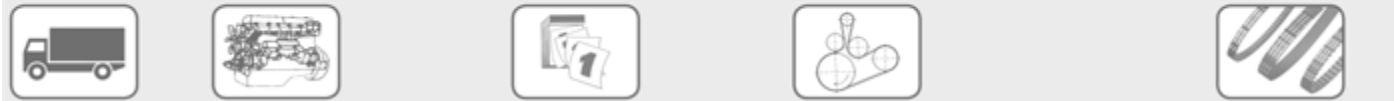

## MERCEDES-BENZ

### ACTROS

#### 2548

15928 ccm	350 kW	OM 542.921;OM 542.940	09.96 - 10.02	ALT	MTR-CODE: OM542.920; OE-NO.: 5419972692; MOD: 2548LS;2548,2548L;SA50516901	11 PK 1890 TM
				ALT	MTR-CODE: OM542.920; OE-NO.: 5419972692; MOD: 2548LS;2548,2548L;SA59902001/02	11 PK 1890 TM
				ALT	MTR-CODE: OM542.920; OE-NO.: 5419972792; MOD: 2548LS;2548,2548L;SA50516111	11 PK 2835 TM
				ALT	MTR-CODE: OM542.920; OE-NO.: 5419972792; MOD: 2548LS;2548,2548L;SA59902001/02	11 PK 2835 TM
				FAN	MTR-CODE: OM542.920; OE-NO.: 5419970892; MOD: 2548LS;2548,2548L;SA50516101	9 PK 1888 TM
				FAN	MTR-CODE: OM542.920; OE-NO.: 5419972592; MOD: 2548LS;2548,2548L;SA50516109	12 PK 1515 TM
				FAN	MTR-CODE: OM542.920; OE-NO.: 5419973092; MOD: 2548LS;2548,2548L;SA50516115	12 PK 1507 TM
				HYD-P	MTR-CODE: OM542.920; OE-NO.: 5419972892; MOD: 2548LS;2548,2548L;SA50516110/11	8 PK 1215 TM
				HYD-P	MTR-CODE: OM542.920; OE-NO.: 5419972892; MOD: 2548LS;2548,2548L;SA50516901	8 PK 1215 TM
				HYD-P	MTR-CODE: OM542.920; OE-NO.: 5419972892; MOD: 2548LS;2548,2548L;SA59902001/02	8 PK 1215 TM
				W-P	MTR-CODE: OM542.920; OE-NO.: 5419970992; MOD: 2548LS;2548,2548L;SA50516102	9 PK 2835 TM
				W-P	MTR-CODE: OM542.920; OE-NO.: 5419971092; MOD: 2548LS;2548,2548L;SA50516103	9 PK 2295 TM
				ALT; AC-C	MTR-CODE: OM 542.920	KT 7004

#### 2553

15928 ccm	390 kW	OM 542.920	09.96 - 10.02	ALT	OE-NO.: 5419972692; MOD: 2548LS;2548,2548L;SA50516110	11 PK 1890 TM
				ALT	OE-NO.: 5419972692; MOD: 2548LS;2548,2548L;SA50516901	11 PK 1890 TM
				ALT	OE-NO.: 5419972692; MOD: 2548LS;2548,2548L;SA59902001/02	11 PK 1890 TM
				ALT	OE-NO.: 5419972792; MOD: 2548LS;2548,2548L;SA50516111	11 PK 2835 TM
				ALT	OE-NO.: 5419972792; MOD: 2548LS;2548,2548L;SA59902001/02	11 PK 2835 TM
				FAN	OE-NO.: 5419970892; MOD: 2548LS;2548,2548L;SA50516101	9 PK 1888 TM
				FAN	OE-NO.: 5419972592; MOD: 2548LS;2548,2548L;SA50516109	12 PK 1515 TM
				FAN	OE-NO.: 5419973092; MOD: 2548LS;2548,2548L;SA50516115	12 PK 1507 TM
				HYD-P	OE-NO.: 5419972892; MOD: 2548LS;2548,2548L;SA50516110/11	8 PK 1215 TM
				HYD-P	OE-NO.: 5419972892; MOD: 2548LS;2548,2548L;SA50516901	8 PK 1215 TM
				HYD-P	OE-NO.: 5419972892; MOD: 2548LS;2548,2548L;SA59902001/02	8 PK 1215 TM
				W-P	OE-NO.: 5419970992; MOD: 2548LS;2548,2548L;SA50516102	9 PK 2835 TM
				W-P	OE-NO.: 5419971092; MOD: 2548LS;2548,2548L;SA50516103	9 PK 2295 TM
				ALT; AC-C; PS		KT 7004
		OM 542.920;OM 542.942		ALT	OE-NO.: 5419972692; MOD: 2548LS;2548,2548L;SA50516110	11 PK 1890 TM
				ALT	OE-NO.: 5419972692; MOD: 2548LS;2548,2548L;SA50516901	11 PK 1890 TM
				ALT	OE-NO.: 5419972692; MOD: 2548LS;2548,2548L;SA59902001/02	11 PK 1890 TM
				ALT	OE-NO.: 5419972792; MOD: 2548LS;2548,2548L;SA50516111	11 PK 2835 TM
				ALT	OE-NO.: 5419972792; MOD: 2548LS;2548,2548L;SA59902001/02	11 PK 2835 TM
				FAN	OE-NO.: 5419970892; MOD: 2548LS;2548,2548L;SA50516101	9 PK 1888 TM
				FAN	OE-NO.: 5419972592; MOD: 2548LS;2548,2548L;SA50516109	12 PK 1515 TM
				FAN	OE-NO.: 5419973092; MOD: 2548LS;2548,2548L;SA50516115	12 PK 1507 TM
				HYD-P	OE-NO.: 5419972892; MOD: 2548LS;2548,2548L;SA50516110/11	8 PK 1215 TM
				HYD-P	OE-NO.: 5419972892; MOD: 2548LS;2548,2548L;SA50516901	8 PK 1215 TM



## MERCEDES-BENZ

### ACTROS

#### 2553

15928 ccm	390 kW	OM 542.920;OM 542.942	09.96 - 10.02	HYD-P	OE-NO.: 5419972892; MOD: 2548LS;2548,2548L;SA59902001/02	<b>8 PK 1215 TM</b>
				W-P	OE-NO.: 5419970992; MOD: 2548LS;2548,2548L;SA50516102	<b>9 PK 2835 TM</b>
				W-P	OE-NO.: 5419971092; MOD: 2548LS;2548,2548L;SA50516103	<b>9 PK 2295 TM</b>
				ALT; AC-C; PS		<b>KT 7004</b>

#### 2557

15928 ccm	420 kW	OM 542.922	09.96 - 10.02	ALT	MTR-CODE: OM542.920; OE-NO.: 5419972692; MOD: 2548LS;2548,2548L;SA50516110	<b>11 PK 1890 TM</b>
				ALT	MTR-CODE: OM542.920; OE-NO.: 5419972692; MOD: 2548LS;2548,2548L;SA50516901	<b>11 PK 1890 TM</b>
				ALT	MTR-CODE: OM542.920; OE-NO.: 5419972692; MOD: 2548LS;2548,2548L;SA59902001/02	<b>11 PK 1890 TM</b>
				ALT	MTR-CODE: OM542.920; OE-NO.: 5419972792; MOD: 2548LS;2548,2548L;SA50516111	<b>11 PK 2835 TM</b>
				ALT	MTR-CODE: OM542.920; OE-NO.: 5419972792; MOD: 2548LS;2548,2548L;SA59902001/02	<b>11 PK 2835 TM</b>
				FAN	MTR-CODE: OM542.920; OE-NO.: 5419970892; MOD: 2548LS;2548,2548L;SA50516101	<b>9 PK 1888 TM</b>
				FAN	MTR-CODE: OM542.920; OE-NO.: 5419972592; MOD: 2548LS;2548,2548L;SA50516109	<b>12 PK 1515 TM</b>
				FAN	MTR-CODE: OM542.920; OE-NO.: 5419973092; MOD: 2548LS;2548,2548L;SA50516115	<b>12 PK 1507 TM</b>
				HYD-P	MTR-CODE: OM542.920; OE-NO.: 5419972892; MOD: 2548LS;2548,2548L;SA50516110/11	<b>8 PK 1215 TM</b>
				HYD-P	MTR-CODE: OM542.920; OE-NO.: 5419972892; MOD: 2548LS;2548,2548L;SA50516901	<b>8 PK 1215 TM</b>
				HYD-P	MTR-CODE: OM542.920; OE-NO.: 5419972892; MOD: 2548LS;2548,2548L;SA59902001/02	<b>8 PK 1215 TM</b>
				W-P	MTR-CODE: OM542.920; OE-NO.: 5419970992; MOD: 2548LS;2548,2548L;SA50516102	<b>9 PK 2835 TM</b>
				W-P	MTR-CODE: OM542.920; OE-NO.: 5419971092; MOD: 2548LS;2548,2548L;SA50516103	<b>9 PK 2295 TM</b>
				ALT; AC-C	MTR-CODE: OM 542.920	<b>KT 7004</b>

#### 2631

11946 ccm	230 kW	OM 541.920	04.96 - 10.02	ALT	FROM: 09.96; OE-NO.: 5419972692; MOD: 2631B;2631K;SA50516110	<b>11 PK 1890 TM</b>
				ALT	FROM: 09.96; OE-NO.: 5419972692; MOD: 2631B;2631K;SA50516901	<b>11 PK 1890 TM</b>
				ALT	FROM: 09.96; OE-NO.: 5419972692; MOD: 2631B;2631K;SA59902001/02	<b>11 PK 1890 TM</b>
				ALT	FROM: 09.96; OE-NO.: 5419972792; MOD: 2631B;2631K;SA50516111	<b>11 PK 2835 TM</b>
				ALT	FROM: 09.96; OE-NO.: 5419972792; MOD: 2631B;2631K;SA59902001/02	<b>11 PK 2835 TM</b>
				FAN	FROM: 09.96; OE-NO.: 5419970892; MOD: 2631B;2631K;SA50516101	<b>9 PK 1888 TM</b>
				FAN	FROM: 09.96; OE-NO.: 5419972592; MOD: 2631B;2631K;SA50516109	<b>12 PK 1515 TM</b>
				FAN	FROM: 09.96; OE-NO.: 5419973092; MOD: 2631B;2631K;SA50516115	<b>12 PK 1507 TM</b>
				HYD-P	FROM: 09.96; OE-NO.: 5419972892; MOD: 2631B;2631K;SA50516110/11	<b>8 PK 1215 TM</b>
				HYD-P	FROM: 09.96; OE-NO.: 5419972892; MOD: 2631B;2631K;SA50516901	<b>8 PK 1215 TM</b>
				HYD-P	FROM: 09.96; OE-NO.: 5419972892; MOD: 2631B;2631K;SA59902001/02	<b>8 PK 1215 TM</b>
				W-P	FROM: 09.96; OE-NO.: 5419970992; MOD: 2631B;2631K;SA50516102	<b>9 PK 2835 TM</b>
				W-P	FROM: 09.96; OE-NO.: 5419971092; MOD: 2631B;2631K;SA50516103	<b>9 PK 2295 TM</b>
				ALT; AC-C; PS		<b>KT 7004</b>
		OM 541.920;OM 541.940		ALT	OE-NO.: 5419972692; MOD: 2631B;2631K;SA50516110	<b>11 PK 1890 TM</b>
				ALT	OE-NO.: 5419972692; MOD: 2631B;2631K;SA50516901	<b>11 PK 1890 TM</b>
				ALT	OE-NO.: 5419972692; MOD: 2631B;2631K;SA59902001/02	<b>11 PK 1890 TM</b>
				ALT	OE-NO.: 5419972792; MOD: 2631B;2631K;SA50516111	<b>11 PK 2835 TM</b>
				ALT	OE-NO.: 5419972792; MOD: 2631B;2631K;SA59902001/02	<b>11 PK 2835 TM</b>

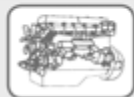

## MERCEDES-BENZ

### ACTROS

#### 2631

11946 ccm	230 kW	OM 541.920;OM 541.940	04.96 - 10.02	FAN	OE-NO.: 5419970892; MOD: 2631B;2631K;SA50516101	9 PK 1888 TM
				FAN	OE-NO.: 5419972592; MOD: 2631B;2631K;SA50516109	12 PK 1515 TM
				FAN	OE-NO.: 5419973092; MOD: 2631B;2631K;SA50516115	12 PK 1507 TM
				HYD-P	OE-NO.: 5419972892; MOD: 2631B;2631K;SA50516110/11	8 PK 1215 TM
				HYD-P	OE-NO.: 5419972892; MOD: 2631B;2631K;SA50516901	8 PK 1215 TM
				HYD-P	OE-NO.: 5419972892; MOD: 2631B;2631K;SA59902001/02	8 PK 1215 TM
				W-P	OE-NO.: 5419970992; MOD: 2631B;2631K;SA50516102	9 PK 2835 TM
				W-P	OE-NO.: 5419971092; MOD: 2631B;2631K;SA50516103	9 PK 2295 TM
				ALT; AC-C; PS		KT 7004

#### 2635

11946 ccm	260 kW	OM 541.922	04.96 - 10.02	ALT	FROM: 09.96; MTR-CODE: OM541.920; OE-NO.: 5419972692; MOD: 2631B;2631K;SA50516110	11 PK 1890 TM
				ALT	FROM: 09.96; MTR-CODE: OM541.920; OE-NO.: 5419972692; MOD: 2631B;2631K;SA50516901	11 PK 1890 TM
				ALT	FROM: 09.96; MTR-CODE: OM541.920; OE-NO.: 5419972692; MOD: 2631B;2631K;SA59902001/02	11 PK 1890 TM
				ALT	FROM: 09.96; MTR-CODE: OM541.920; OE-NO.: 5419972792; MOD: 2631B;2631K;SA50516111	11 PK 2835 TM
				ALT	FROM: 09.96; MTR-CODE: OM541.920; OE-NO.: 5419972792; MOD: 2631B;2631K;SA59902001/02	11 PK 2835 TM
				FAN	FROM: 09.96; MTR-CODE: OM541.920; OE-NO.: 5419970892; MOD: 2631B;2631K;SA50516101	9 PK 1888 TM
				FAN	FROM: 09.96; MTR-CODE: OM541.920; OE-NO.: 5419972592; MOD: 2631B;2631K;SA50516109	12 PK 1515 TM
				FAN	FROM: 09.96; MTR-CODE: OM541.920; OE-NO.: 5419973092; MOD: 2631B;2631K;SA50516115	12 PK 1507 TM
				HYD-P	FROM: 09.96; MTR-CODE: OM541.920; OE-NO.: 5419972892; MOD: 2631B;2631K;SA50516110/11	8 PK 1215 TM
				HYD-P	FROM: 09.96; MTR-CODE: OM541.920; OE-NO.: 5419972892; MOD: 2631B;2631K;SA50516901	8 PK 1215 TM
				HYD-P	FROM: 09.96; MTR-CODE: OM541.920; OE-NO.: 5419972892; MOD: 2631B;2631K;SA59902001/02	8 PK 1215 TM
				W-P	FROM: 09.96; MTR-CODE: OM541.920; OE-NO.: 5419970992; MOD: 2631B;2631K;SA50516102	9 PK 2835 TM
				W-P	FROM: 09.96; MTR-CODE: OM541.920; OE-NO.: 5419971092; MOD: 2631B;2631K;SA50516103	9 PK 2295 TM
				ALT; AC-C	MTR-CODE: OM 541.920	KT 7004
		OM 541.922;OM 541.942		ALT	MTR-CODE: OM541.920; OE-NO.: 5419972692; MOD: 2631B;2631K;SA50516110	11 PK 1890 TM
				ALT	MTR-CODE: OM541.920; OE-NO.: 5419972692; MOD: 2631B;2631K;SA50516901	11 PK 1890 TM
				ALT	MTR-CODE: OM541.920; OE-NO.: 5419972692; MOD: 2631B;2631K;SA59902001/02	11 PK 1890 TM
				ALT	MTR-CODE: OM541.920; OE-NO.: 5419972792; MOD: 2631B;2631K;SA50516111	11 PK 2835 TM
				ALT	MTR-CODE: OM541.920; OE-NO.: 5419972792; MOD: 2631B;2631K;SA59902001/02	11 PK 2835 TM
				FAN	MTR-CODE: OM541.920; OE-NO.: 5419970892; MOD: 2631B;2631K;SA50516101	9 PK 1888 TM
				FAN	MTR-CODE: OM541.920; OE-NO.: 5419972592; MOD: 2631B;2631K;SA50516109	12 PK 1515 TM
				FAN	MTR-CODE: OM541.920; OE-NO.: 5419973092; MOD: 2631B;2631K;SA50516115	12 PK 1507 TM

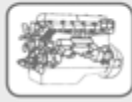

## MERCEDES-BENZ

### ACTROS

#### 2635

11946 ccm	260 kW	OM 541.922;OM 541.942	04.96 - 10.02	HYD-P	MTR-CODE: OM541.920; OE-NO.: 5419972892; MOD: 2631B;2631K;SA50516110/11	<b>8 PK 1215 TM</b>
				HYD-P	MTR-CODE: OM541.920; OE-NO.: 5419972892; MOD: 2631B;2631K;SA50516901	<b>8 PK 1215 TM</b>
				HYD-P	MTR-CODE: OM541.920; OE-NO.: 5419972892; MOD: 2631B;2631K;SA59902001/02	<b>8 PK 1215 TM</b>
				W-P	MTR-CODE: OM541.920; OE-NO.: 5419970992; MOD: 2631B;2631K;SA50516102	<b>9 PK 2835 TM</b>
				W-P	MTR-CODE: OM541.920; OE-NO.: 5419971092; MOD: 2631B;2631K;SA50516103	<b>9 PK 2295 TM</b>
				ALT; AC-C	MTR-CODE: OM 541.920	<b>KT 7004</b>

#### 2640

11946 ccm	290 kW	OM 541.923	04.96 - 10.02	ALT	FROM: 09.96; MTR-CODE: OM541.920; OE-NO.: 5419972692; MOD: 2631B;2631K;SA50516110	<b>11 PK 1890 TM</b>
				ALT	FROM: 09.96; MTR-CODE: OM541.920; OE-NO.: 5419972692; MOD: 2631B;2631K;SA50516901	<b>11 PK 1890 TM</b>
				ALT	FROM: 09.96; MTR-CODE: OM541.920; OE-NO.: 5419972692; MOD: 2631B;2631K;SA59902001/02	<b>11 PK 1890 TM</b>
				ALT	FROM: 09.96; MTR-CODE: OM541.920; OE-NO.: 5419972792; MOD: 2631B;2631K;SA50516111	<b>11 PK 2835 TM</b>
				ALT	FROM: 09.96; MTR-CODE: OM541.920; OE-NO.: 5419972792; MOD: 2631B;2631K;SA59902001/02	<b>11 PK 2835 TM</b>
				FAN	FROM: 09.96; MTR-CODE: OM541.920; OE-NO.: 5419970892; MOD: 2631B;2631K;SA50516101	<b>9 PK 1888 TM</b>
				FAN	FROM: 09.96; MTR-CODE: OM541.920; OE-NO.: 5419972592; MOD: 2631B;2631K;SA50516109	<b>12 PK 1515 TM</b>
				FAN	FROM: 09.96; MTR-CODE: OM541.920; OE-NO.: 5419973092; MOD: 2631B;2631K;SA50516115	<b>12 PK 1507 TM</b>
				HYD-P	FROM: 09.96; MTR-CODE: OM541.920; OE-NO.: 5419972892; MOD: 2631B;2631K;SA50516110/11	<b>8 PK 1215 TM</b>
				HYD-P	FROM: 09.96; MTR-CODE: OM541.920; OE-NO.: 5419972892; MOD: 2631B;2631K;SA50516901	<b>8 PK 1215 TM</b>
				HYD-P	FROM: 09.96; MTR-CODE: OM541.920; OE-NO.: 5419972892; MOD: 2631B;2631K;SA59902001/02	<b>8 PK 1215 TM</b>
				W-P	FROM: 09.96; MTR-CODE: OM541.920; OE-NO.: 5419970992; MOD: 2631B;2631K;SA50516102	<b>9 PK 2835 TM</b>
				W-P	FROM: 09.96; MTR-CODE: OM541.920; OE-NO.: 5419971092; MOD: 2631B;2631K;SA50516103	<b>9 PK 2295 TM</b>
				ALT; AC-C	MTR-CODE: OM 541.920	<b>KT 7004</b>
		OM 541.923;OM 541.944		ALT	MTR-CODE: OM541.920; OE-NO.: 5419972692; MOD: 2631B;2631K;SA50516110	<b>11 PK 1890 TM</b>
				ALT	MTR-CODE: OM541.920; OE-NO.: 5419972692; MOD: 2631B;2631K;SA50516901	<b>11 PK 1890 TM</b>
				ALT	MTR-CODE: OM541.920; OE-NO.: 5419972692; MOD: 2631B;2631K;SA59902001/02	<b>11 PK 1890 TM</b>
				ALT	MTR-CODE: OM541.920; OE-NO.: 5419972792; MOD: 2631B;2631K;SA50516111	<b>11 PK 2835 TM</b>
				ALT	MTR-CODE: OM541.920; OE-NO.: 5419972792; MOD: 2631B;2631K;SA59902001/02	<b>11 PK 2835 TM</b>
				FAN	MTR-CODE: OM541.920; OE-NO.: 5419970892; MOD: 2631B;2631K;SA50516101	<b>9 PK 1888 TM</b>
				FAN	MTR-CODE: OM541.920; OE-NO.: 5419972592; MOD: 2631B;2631K;SA50516109	<b>12 PK 1515 TM</b>
				FAN	MTR-CODE: OM541.920; OE-NO.: 5419973092; MOD: 2631B;2631K;SA50516115	<b>12 PK 1507 TM</b>
				HYD-P	MTR-CODE: OM541.920; OE-NO.: 5419972892; MOD: 2631B;2631K;SA50516110/11	<b>8 PK 1215 TM</b>
				HYD-P	MTR-CODE: OM541.920; OE-NO.: 5419972892; MOD: 2631B;2631K;SA50516901	<b>8 PK 1215 TM</b>
				HYD-P	MTR-CODE: OM541.920; OE-NO.: 5419972892; MOD: 2631B;2631K;SA59902001/02	<b>8 PK 1215 TM</b>

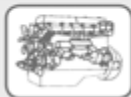

## MERCEDES-BENZ

### ACTROS

#### 2640

11946 ccm	290 kW	OM 541.923;OM 541.944	04.96 - 10.02	W-P	MTR-CODE: OM541.920; OE-NO.: 5419970992; MOD: 2631B;2631K;SA50516102	<b>9 PK 2835 TM</b>
				W-P	MTR-CODE: OM541.920; OE-NO.: 5419971092; MOD: 2631B;2631K;SA50516103	<b>9 PK 2295 TM</b>
				ALT; AC-C	MTR-CODE: OM 541.920	<b>KT 7004</b>

#### 2643

11946 ccm	315 kW	OM 541.925	04.96 - 10.02	ALT	FROM: 09.96; MTR-CODE: OM541.920; OE-NO.: 5419972692; MOD: 2631B;2631K;SA50516110	<b>11 PK 1890 TM</b>
				ALT	FROM: 09.96; MTR-CODE: OM541.920; OE-NO.: 5419972692; MOD: 2631B;2631K;SA50516901	<b>11 PK 1890 TM</b>
				ALT	FROM: 09.96; MTR-CODE: OM541.920; OE-NO.: 5419972692; MOD: 2631B;2631K;SA59902001/02	<b>11 PK 1890 TM</b>
				ALT	FROM: 09.96; MTR-CODE: OM541.920; OE-NO.: 5419972792; MOD: 2631B;2631K;SA50516111	<b>11 PK 2835 TM</b>
				ALT	FROM: 09.96; MTR-CODE: OM541.920; OE-NO.: 5419972792; MOD: 2631B;2631K;SA59902001/02	<b>11 PK 2835 TM</b>
				FAN	FROM: 09.96; MTR-CODE: OM541.920; OE-NO.: 5419970892; MOD: 2631B;2631K;SA50516101	<b>9 PK 1888 TM</b>
				FAN	FROM: 09.96; MTR-CODE: OM541.920; OE-NO.: 5419972592; MOD: 2631B;2631K;SA50516109	<b>12 PK 1515 TM</b>
				FAN	FROM: 09.96; MTR-CODE: OM541.920; OE-NO.: 5419973092; MOD: 2631B;2631K;SA50516115	<b>12 PK 1507 TM</b>
				HYD-P	FROM: 09.96; MTR-CODE: OM541.920; OE-NO.: 5419972892; MOD: 2631B;2631K;SA50516110/11	<b>8 PK 1215 TM</b>
				HYD-P	FROM: 09.96; MTR-CODE: OM541.920; OE-NO.: 5419972892; MOD: 2631B;2631K;SA50516901	<b>8 PK 1215 TM</b>
				HYD-P	FROM: 09.96; MTR-CODE: OM541.920; OE-NO.: 5419972892; MOD: 2631B;2631K;SA59902001/02	<b>8 PK 1215 TM</b>
				W-P	FROM: 09.96; MTR-CODE: OM541.920; OE-NO.: 5419970992; MOD: 2631B;2631K;SA50516102	<b>9 PK 2835 TM</b>
				W-P	FROM: 09.96; MTR-CODE: OM541.920; OE-NO.: 5419971092; MOD: 2631B;2631K;SA50516103	<b>9 PK 2295 TM</b>
				ALT; AC-C	MTR-CODE: OM 541.920	<b>KT 7004</b>
		OM 541.925;OM 541.946		ALT	MTR-CODE: OM541.920; OE-NO.: 5419972692; MOD: 2631B;2631K;SA50516110	<b>11 PK 1890 TM</b>
				ALT	MTR-CODE: OM541.920; OE-NO.: 5419972692; MOD: 2631B;2631K;SA50516901	<b>11 PK 1890 TM</b>
				ALT	MTR-CODE: OM541.920; OE-NO.: 5419972692; MOD: 2631B;2631K;SA59902001/02	<b>11 PK 1890 TM</b>
				ALT	MTR-CODE: OM541.920; OE-NO.: 5419972792; MOD: 2631B;2631K;SA50516111	<b>11 PK 2835 TM</b>
				ALT	MTR-CODE: OM541.920; OE-NO.: 5419972792; MOD: 2631B;2631K;SA59902001/02	<b>11 PK 2835 TM</b>
				FAN	MTR-CODE: OM541.920; OE-NO.: 5419970892; MOD: 2631B;2631K;SA50516101	<b>9 PK 1888 TM</b>
				FAN	MTR-CODE: OM541.920; OE-NO.: 5419972592; MOD: 2631B;2631K;SA50516109	<b>12 PK 1515 TM</b>
				FAN	MTR-CODE: OM541.920; OE-NO.: 5419973092; MOD: 2631B;2631K;SA50516115	<b>12 PK 1507 TM</b>
				HYD-P	MTR-CODE: OM541.920; OE-NO.: 5419972892; MOD: 2631B;2631K;SA50516110/11	<b>8 PK 1215 TM</b>
				HYD-P	MTR-CODE: OM541.920; OE-NO.: 5419972892; MOD: 2631B;2631K;SA50516901	<b>8 PK 1215 TM</b>
				HYD-P	MTR-CODE: OM541.920; OE-NO.: 5419972892; MOD: 2631B;2631K;SA59902001/02	<b>8 PK 1215 TM</b>
				W-P	MTR-CODE: OM541.920; OE-NO.: 5419970992; MOD: 2631B;2631K;SA50516102	<b>9 PK 2835 TM</b>
				W-P	MTR-CODE: OM541.920; OE-NO.: 5419971092; MOD: 2631B;2631K;SA50516103	<b>9 PK 2295 TM</b>
				ALT; AC-C	MTR-CODE: OM 541.920	<b>KT 7004</b>



## MERCEDES-BENZ

### ACTROS

#### 2648

15928 ccm	350 kW	OM 542.921	04.96 -	ALT	FROM: 09.96; MTR-CODE: OM542.920; OE-NO.: 5419972692; MOD: 2648K,2648LK;SA50516110	11 PK 1890 TM
				ALT	FROM: 09.96; MTR-CODE: OM542.920; OE-NO.: 5419972692; MOD: 2648K,2648LK;SA50516901	11 PK 1890 TM
				ALT	FROM: 09.96; MTR-CODE: OM542.920; OE-NO.: 5419972692; MOD: 2648K,2648LK;SA59902001/02	11 PK 1890 TM
				ALT	FROM: 09.96; MTR-CODE: OM542.920; OE-NO.: 5419972792; MOD: 2648K,2648LK;SA50516111	11 PK 2835 TM
				ALT	FROM: 09.96; MTR-CODE: OM542.920; OE-NO.: 5419972792; MOD: 2648K,2648LK;SA59902001/02	11 PK 2835 TM
				FAN	FROM: 09.96; MTR-CODE: OM542.920; OE-NO.: 5419970892; MOD: 2648K,2648LK;SA50516101	9 PK 1888 TM
				FAN	FROM: 09.96; MTR-CODE: OM542.920; OE-NO.: 5419972592; MOD: 2648K,2648LK;SA50516109	12 PK 1515 TM
				FAN	FROM: 09.96; MTR-CODE: OM542.920; OE-NO.: 5419973092; MOD: 2648K,2648LK;SA50516115	12 PK 1507 TM
				HYD-P	FROM: 09.96; MTR-CODE: OM542.920; OE-NO.: 5419972892; MOD: 2648K,2648LK;SA50516110/11	8 PK 1215 TM
				HYD-P	FROM: 09.96; MTR-CODE: OM542.920; OE-NO.: 5419972892; MOD: 2648K,2648LK;SA50516901	8 PK 1215 TM
				HYD-P	FROM: 09.96; MTR-CODE: OM542.920; OE-NO.: 5419972892; MOD: 2648K,2648LK;SA59902001/02	8 PK 1215 TM
				W-P	FROM: 09.96; MTR-CODE: OM542.920; OE-NO.: 5419970992; MOD: 2648K,2648LK;SA50516102	9 PK 2835 TM
				W-P	FROM: 09.96; MTR-CODE: OM542.920; OE-NO.: 5419971092; MOD: 2648K,2648LK;SA50516103	9 PK 2295 TM
				ALT; AC-C	MTR-CODE: OM 542.920	KT 7004
		OM 542.921;OM 542.940		ALT	MTR-CODE: OM542.920; OE-NO.: 5419972692; MOD: 2648K,2648LK;SA50516110	11 PK 1890 TM
				ALT	MTR-CODE: OM542.920; OE-NO.: 5419972692; MOD: 2648K,2648LK;SA50516901	11 PK 1890 TM
				ALT	MTR-CODE: OM542.920; OE-NO.: 5419972692; MOD: 2648K,2648LK;SA59902001/02	11 PK 1890 TM
				ALT	MTR-CODE: OM542.920; OE-NO.: 5419972792; MOD: 2648K,2648LK;SA50516111	11 PK 2835 TM
				ALT	MTR-CODE: OM542.920; OE-NO.: 5419972792; MOD: 2648K,2648LK;SA59902001/02	11 PK 2835 TM
				FAN	MTR-CODE: OM542.920; OE-NO.: 5419970892; MOD: 2648K,2648LK;SA50516101	9 PK 1888 TM
				FAN	MTR-CODE: OM542.920; OE-NO.: 5419972592; MOD: 2648K,2648LK;SA50516109	12 PK 1515 TM
				FAN	MTR-CODE: OM542.920; OE-NO.: 5419973092; MOD: 2648K,2648LK;SA50516115	12 PK 1507 TM
				HYD-P	MTR-CODE: OM542.920; OE-NO.: 5419972892; MOD: 2648K,2648LK;SA50516110/11	8 PK 1215 TM
				HYD-P	MTR-CODE: OM542.920; OE-NO.: 5419972892; MOD: 2648K,2648LK;SA50516901	8 PK 1215 TM
				HYD-P	MTR-CODE: OM542.920; OE-NO.: 5419972892; MOD: 2648K,2648LK;SA59902001/02	8 PK 1215 TM
				W-P	MTR-CODE: OM542.920; OE-NO.: 5419970992; MOD: 2648K,2648LK;SA50516102	9 PK 2835 TM
				W-P	MTR-CODE: OM542.920; OE-NO.: 5419971092; MOD: 2648K,2648LK;SA50516103	9 PK 2295 TM
				ALT; AC-C	MTR-CODE: OM 542.920	KT 7004

#### 2653

15928 ccm	390 kW	OM 542.920	04.96 - 10.02	ALT	FROM: 09.96; OE-NO.: 5419972692; MOD: 2648K,2648LK;SA50516110	11 PK 1890 TM
				ALT	FROM: 09.96; OE-NO.: 5419972692; MOD: 2648K,2648LK;SA50516901	11 PK 1890 TM
				ALT	FROM: 09.96; OE-NO.: 5419972692; MOD: 2648K,2648LK;SA59902001/02	11 PK 1890 TM

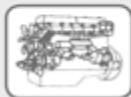

## MERCEDES-BENZ

### ACTROS

#### 2653

15928 ccm	390 kW	OM 542.920	04.96 - 10.02	ALT	FROM: 09.96; OE-NO.: 5419972792; MOD: 2648K,2648LK;SA50516111	11 PK 2835 TM
				ALT	FROM: 09.96; OE-NO.: 5419972792; MOD: 2648K,2648LK;SA59902001/02	11 PK 2835 TM
				FAN	FROM: 09.96; OE-NO.: 5419970892; MOD: 2648K,2648LK;SA50516101	9 PK 1888 TM
				FAN	FROM: 09.96; OE-NO.: 5419972592; MOD: 2648K,2648LK;SA50516109	12 PK 1515 TM
				FAN	FROM: 09.96; OE-NO.: 5419973092; MOD: 2648K,2648LK;SA50516115	12 PK 1507 TM
				HYD-P	FROM: 09.96; OE-NO.: 5419972892; MOD: 2648K,2648LK;SA50516110/11	8 PK 1215 TM
				HYD-P	FROM: 09.96; OE-NO.: 5419972892; MOD: 2648K,2648LK;SA50516901	8 PK 1215 TM
				HYD-P	FROM: 09.96; OE-NO.: 5419972892; MOD: 2648K,2648LK;SA59902001/02	8 PK 1215 TM
				W-P	FROM: 09.96; OE-NO.: 5419970992; MOD: 2648K,2648LK;SA50516102	9 PK 2835 TM
				W-P	FROM: 09.96; OE-NO.: 5419971092; MOD: 2648K,2648LK;SA50516103	9 PK 2295 TM
				ALT; AC-C; PS		KT 7004
		OM 542.920;OM 542.942		ALT	OE-NO.: 5419972692; MOD: 2648K,2648LK;SA50516110	11 PK 1890 TM
				ALT	OE-NO.: 5419972692; MOD: 2648K,2648LK;SA50516901	11 PK 1890 TM
				ALT	OE-NO.: 5419972692; MOD: 2648K,2648LK;SA59902001/02	11 PK 1890 TM
				ALT	OE-NO.: 5419972792; MOD: 2648K,2648LK;SA50516111	11 PK 2835 TM
				ALT	OE-NO.: 5419972792; MOD: 2648K,2648LK;SA59902001/02	11 PK 2835 TM
				FAN	OE-NO.: 5419970892; MOD: 2648K,2648LK;SA50516101	9 PK 1888 TM
				FAN	OE-NO.: 5419972592; MOD: 2648K,2648LK;SA50516109	12 PK 1515 TM
				FAN	OE-NO.: 5419973092; MOD: 2648K,2648LK;SA50516115	12 PK 1507 TM
				HYD-P	OE-NO.: 5419972892; MOD: 2648K,2648LK;SA50516110/11	8 PK 1215 TM
				HYD-P	OE-NO.: 5419972892; MOD: 2648K,2648LK;SA50516901	8 PK 1215 TM
				HYD-P	OE-NO.: 5419972892; MOD: 2648K,2648LK;SA59902001/02	8 PK 1215 TM
				W-P	OE-NO.: 5419970992; MOD: 2648K,2648LK;SA50516102	9 PK 2835 TM
				W-P	OE-NO.: 5419971092; MOD: 2648K,2648LK;SA50516103	9 PK 2295 TM
				ALT; AC-C; PS		KT 7004

#### 2657

15928 ccm	420 kW	OM 542.922	04.97 - 10.02	ALT	MTR-CODE: OM542.920; OE-NO.: 5419972692; MOD: 2648K,2648LK;SA50516110	11 PK 1890 TM
				ALT	MTR-CODE: OM542.920; OE-NO.: 5419972692; MOD: 2648K,2648LK;SA50516901	11 PK 1890 TM
				ALT	MTR-CODE: OM542.920; OE-NO.: 5419972692; MOD: 2648K,2648LK;SA59902001/02	11 PK 1890 TM
				ALT	MTR-CODE: OM542.920; OE-NO.: 5419972792; MOD: 2648K,2648LK;SA50516111	11 PK 2835 TM
				ALT	MTR-CODE: OM542.920; OE-NO.: 5419972792; MOD: 2648K,2648LK;SA59902001/02	11 PK 2835 TM
				FAN	MTR-CODE: OM542.920; OE-NO.: 5419970892; MOD: 2648K,2648LK;SA50516101	9 PK 1888 TM
				FAN	MTR-CODE: OM542.920; OE-NO.: 5419972592; MOD: 2648K,2648LK;SA50516109	12 PK 1515 TM
				FAN	MTR-CODE: OM542.920; OE-NO.: 5419973092; MOD: 2648K,2648LK;SA50516115	12 PK 1507 TM
				HYD-P	MTR-CODE: OM542.920; OE-NO.: 5419972892; MOD: 2648K,2648LK;SA50516110/11	8 PK 1215 TM
				HYD-P	MTR-CODE: OM542.920; OE-NO.: 5419972892; MOD: 2648K,2648LK;SA50516901	8 PK 1215 TM
				HYD-P	MTR-CODE: OM542.920; OE-NO.: 5419972892; MOD: 2648K,2648LK;SA59902001/02	8 PK 1215 TM
				W-P	MTR-CODE: OM542.920; OE-NO.: 5419970992; MOD: 2648K,2648LK;SA50516102	9 PK 2835 TM



## MERCEDES-BENZ

### ACTROS

#### 2657

15928 ccm	420 kW	OM 542.922	04.97 - 10.02	W-P	MTR-CODE: OM542.920; OE-NO.: 5419971092; MOD: 2648K,2648LK;SA50516103	<b>9 PK 2295 TM</b>
				ALT; AC-C	MTR-CODE: OM 542.920	<b>KT 7004</b>
		OM 542.922;OM 542.944		ALT	MTR-CODE: OM542.920; OE-NO.: 5419972692; MOD: 2648K,2648LK;SA50516110	<b>11 PK 1890 TM</b>
				ALT	MTR-CODE: OM542.920; OE-NO.: 5419972692; MOD: 2648K,2648LK;SA50516901	<b>11 PK 1890 TM</b>
				ALT	MTR-CODE: OM542.920; OE-NO.: 5419972692; MOD: 2648K,2648LK;SA59902001/02	<b>11 PK 1890 TM</b>
				ALT	MTR-CODE: OM542.920; OE-NO.: 5419972792; MOD: 2648K,2648LK;SA50516111	<b>11 PK 2835 TM</b>
				ALT	MTR-CODE: OM542.920; OE-NO.: 5419972792; MOD: 2648K,2648LK;SA59902001/02	<b>11 PK 2835 TM</b>
				FAN	MTR-CODE: OM542.920; OE-NO.: 5419970892; MOD: 2648K,2648LK;SA50516101	<b>9 PK 1888 TM</b>
				FAN	MTR-CODE: OM542.920; OE-NO.: 5419972592; MOD: 2648K,2648LK;SA50516109	<b>12 PK 1515 TM</b>
				FAN	MTR-CODE: OM542.920; OE-NO.: 5419973092; MOD: 2648K,2648LK;SA50516115	<b>12 PK 1507 TM</b>
				HYD-P	MTR-CODE: OM542.920; OE-NO.: 5419972892; MOD: 2648K,2648LK;SA50516110/11	<b>8 PK 1215 TM</b>
				HYD-P	MTR-CODE: OM542.920; OE-NO.: 5419972892; MOD: 2648K,2648LK;SA50516901	<b>8 PK 1215 TM</b>
				HYD-P	MTR-CODE: OM542.920; OE-NO.: 5419972892; MOD: 2648K,2648LK;SA59902001/02	<b>8 PK 1215 TM</b>
				W-P	MTR-CODE: OM542.920; OE-NO.: 5419970992; MOD: 2648K,2648LK;SA50516102	<b>9 PK 2835 TM</b>
				W-P	MTR-CODE: OM542.920; OE-NO.: 5419971092; MOD: 2648K,2648LK;SA50516103	<b>9 PK 2295 TM</b>
				ALT; AC-C	MTR-CODE: OM 542.920	<b>KT 7004</b>

#### 3231

11946 ccm	230 kW	OM 541.920;OM 541.940	04.97 - 10.02	ALT	OE-NO.: 5419972692; MOD: 3231B;3231K;SA50516110	<b>11 PK 1890 TM</b>
				ALT	OE-NO.: 5419972692; MOD: 3231B;3231K;SA50516901	<b>11 PK 1890 TM</b>
				ALT	OE-NO.: 5419972692; MOD: 3231B;3231K;SA59902001/02	<b>11 PK 1890 TM</b>
				ALT	OE-NO.: 5419972792; MOD: 3231B;3231K;SA50516111	<b>11 PK 2835 TM</b>
				ALT	OE-NO.: 5419972792; MOD: 3231B;3231K;SA59902001/02	<b>11 PK 2835 TM</b>
				FAN	OE-NO.: 5419970892; MOD: 3231B;3231K;SA50516101	<b>9 PK 1888 TM</b>
				FAN	OE-NO.: 5419972592; MOD: 3231B;3231K;SA50516109	<b>12 PK 1515 TM</b>
				FAN	OE-NO.: 5419973092; MOD: 3231B;3231K;SA50516115	<b>12 PK 1507 TM</b>
				HYD-P	OE-NO.: 5419972892; MOD: 3231B;3231K;SA50516110/11	<b>8 PK 1215 TM</b>
				HYD-P	OE-NO.: 5419972892; MOD: 3231B;3231K;SA50516901	<b>8 PK 1215 TM</b>
				HYD-P	OE-NO.: 5419972892; MOD: 3231B;3231K;SA59902001/02	<b>8 PK 1215 TM</b>
				W-P	OE-NO.: 5419970992; MOD: 3231B;3231K;SA50516102	<b>9 PK 2835 TM</b>
				W-P	OE-NO.: 5419971092; MOD: 3231B;3231K;SA50516103	<b>9 PK 2295 TM</b>
				ALT; AC-C; PS		<b>KT 7004</b>

#### 3235

11946 ccm	260 kW	OM 541.922;OM 541.942	04.97 - 10.02	ALT	MTR-CODE: OM541.920; OE-NO.: 5419972692; MOD: 3231B;3231K;SA50516110	<b>11 PK 1890 TM</b>
				ALT	MTR-CODE: OM541.920; OE-NO.: 5419972692; MOD: 3231B;3231K;SA50516901	<b>11 PK 1890 TM</b>
				ALT	MTR-CODE: OM541.920; OE-NO.: 5419972692; MOD: 3231B;3231K;SA59902001/02	<b>11 PK 1890 TM</b>
				ALT	MTR-CODE: OM541.920; OE-NO.: 5419972792; MOD: 3231B;3231K;SA50516111	<b>11 PK 2835 TM</b>
				ALT	MTR-CODE: OM541.920; OE-NO.: 5419972792; MOD: 3231B;3231K;SA59902001/02	<b>11 PK 2835 TM</b>
				FAN	MTR-CODE: OM541.920; OE-NO.: 5419970892; MOD: 3231B;3231K;SA50516101	<b>9 PK 1888 TM</b>
				FAN	MTR-CODE: OM541.920; OE-NO.: 5419972592; MOD: 3231B;3231K;SA50516109	<b>12 PK 1515 TM</b>



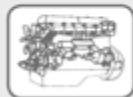

## MERCEDES-BENZ

### ACTROS

#### 3235

11946 ccm	260 kW	OM 541.922;OM 541.942	04.97 - 10.02	FAN	MTR-CODE: OM541.920; OE-NO.: 5419973092; MOD: 3231B;3231K;SA50516115	12 PK 1507 TM
				HYD-P	MTR-CODE: OM541.920; OE-NO.: 5419972892; MOD: 3231B;3231K;SA50516110/11	8 PK 1215 TM
				HYD-P	MTR-CODE: OM541.920; OE-NO.: 5419972892; MOD: 3231B;3231K;SA50516901	8 PK 1215 TM
				HYD-P	MTR-CODE: OM541.920; OE-NO.: 5419972892; MOD: 3231B;3231K;SA59902001/02	8 PK 1215 TM
				W-P	MTR-CODE: OM541.920; OE-NO.: 5419970992; MOD: 3231B;3231K;SA50516102	9 PK 2835 TM
				W-P	MTR-CODE: OM541.920; OE-NO.: 5419971092; MOD: 3231B;3231K;SA50516103	9 PK 2295 TM
				ALT; AC-C	MTR-CODE: OM 541.920	KT 7004

#### 3240

11946 ccm	290 kW	OM 541.923;OM 541.944	04.97 - 10.02	ALT	MTR-CODE: OM541.920; OE-NO.: 5419972692; MOD: 3231B;3231K;SA50516110	11 PK 1890 TM
				ALT	MTR-CODE: OM541.920; OE-NO.: 5419972692; MOD: 3231B;3231K;SA50516901	11 PK 1890 TM
				ALT	MTR-CODE: OM541.920; OE-NO.: 5419972692; MOD: 3231B;3231K;SA59902001/02	11 PK 1890 TM
				ALT	MTR-CODE: OM541.920; OE-NO.: 5419972792; MOD: 3231B;3231K;SA50516111	11 PK 2835 TM
				ALT	MTR-CODE: OM541.920; OE-NO.: 5419972792; MOD: 3231B;3231K;SA59902001/02	11 PK 2835 TM
				FAN	MTR-CODE: OM541.920; OE-NO.: 5419970892; MOD: 3231B;3231K;SA50516101	9 PK 1888 TM
				FAN	MTR-CODE: OM541.920; OE-NO.: 5419972592; MOD: 3231B;3231K;SA50516109	12 PK 1515 TM
				FAN	MTR-CODE: OM541.920; OE-NO.: 5419973092; MOD: 3231B;3231K;SA50516115	12 PK 1507 TM
				HYD-P	MTR-CODE: OM541.920; OE-NO.: 5419972892; MOD: 3231B;3231K;SA50516110/11	8 PK 1215 TM
				HYD-P	MTR-CODE: OM541.920; OE-NO.: 5419972892; MOD: 3231B;3231K;SA50516901	8 PK 1215 TM
				HYD-P	MTR-CODE: OM541.920; OE-NO.: 5419972892; MOD: 3231B;3231K;SA59902001/02	8 PK 1215 TM
				W-P	MTR-CODE: OM541.920; OE-NO.: 5419970992; MOD: 3231B;3231K;SA50516102	9 PK 2835 TM
				W-P	MTR-CODE: OM541.920; OE-NO.: 5419971092; MOD: 3231B;3231K;SA50516103	9 PK 2295 TM
				ALT; AC-C	MTR-CODE: OM 541.920	KT 7004

#### 3243

11946 ccm	315 kW	OM 541.925;OM 541.946	04.97 - 10.02	ALT	MTR-CODE: OM541.920; OE-NO.: 5419972692; MOD: 3231B;3231K;SA50516110	11 PK 1890 TM
				ALT	MTR-CODE: OM541.920; OE-NO.: 5419972692; MOD: 3231B;3231K;SA50516901	11 PK 1890 TM
				ALT	MTR-CODE: OM541.920; OE-NO.: 5419972692; MOD: 3231B;3231K;SA59902001/02	11 PK 1890 TM
				ALT	MTR-CODE: OM541.920; OE-NO.: 5419972792; MOD: 3231B;3231K;SA50516111	11 PK 2835 TM
				ALT	MTR-CODE: OM541.920; OE-NO.: 5419972792; MOD: 3231B;3231K;SA59902001/02	11 PK 2835 TM
				FAN	MTR-CODE: OM541.920; OE-NO.: 5419970892; MOD: 3231B;3231K;SA50516101	9 PK 1888 TM
				FAN	MTR-CODE: OM541.920; OE-NO.: 5419972592; MOD: 3231B;3231K;SA50516109	12 PK 1515 TM
				FAN	MTR-CODE: OM541.920; OE-NO.: 5419973092; MOD: 3231B;3231K;SA50516115	12 PK 1507 TM
				HYD-P	MTR-CODE: OM541.920; OE-NO.: 5419972892; MOD: 3231B;3231K;SA50516110/11	8 PK 1215 TM
				HYD-P	MTR-CODE: OM541.920; OE-NO.: 5419972892; MOD: 3231B;3231K;SA50516901	8 PK 1215 TM
				HYD-P	MTR-CODE: OM541.920; OE-NO.: 5419972892; MOD: 3231B;3231K;SA59902001/02	8 PK 1215 TM
				W-P	MTR-CODE: OM541.920; OE-NO.: 5419970992; MOD: 3231B;3231K;SA50516102	9 PK 2835 TM
				W-P	MTR-CODE: OM541.920; OE-NO.: 5419971092; MOD: 3231B;3231K;SA50516103	9 PK 2295 TM
				ALT; AC-C	MTR-CODE: OM 541.920	KT 7004

#### 3331

11946 ccm	230 kW	OM 541.920	04.97 - 10.02	ALT	OE-NO.: 5419972692; MOD: 3331;3331A;3331AK;SA50516110	11 PK 1890 TM
-----------	--------	------------	---------------	-----	---	---------------



## MERCEDES-BENZ

### ACTROS

#### 3331

11946 ccm	230 kW	OM 541.920	04.97 - 10.02	ALT	OE-NO.: 5419972692; MOD: 3331;3331A;3331AK;SA50516901	11 PK 1890 TM
				ALT	OE-NO.: 5419972692; MOD: 3331;3331A;3331AK;SA59902001/02	11 PK 1890 TM
				ALT	OE-NO.: 5419972792; MOD: 3331;3331A;3331AK;SA50516111	11 PK 2835 TM
				ALT	OE-NO.: 5419972792; MOD: 3331;3331A;3331AK;SA59902001/02	11 PK 2835 TM
				FAN	OE-NO.: 5419970892; MOD: 3331;3331A;3331AK;SA50516101	9 PK 1888 TM
				FAN	OE-NO.: 5419972592; MOD: 3331;3331A;3331AK;SA50516109	12 PK 1515 TM
				FAN	OE-NO.: 5419973092; MOD: 3331;3331A;3331AK;SA50516115	12 PK 1507 TM
				HYD-P	OE-NO.: 5419972892; MOD: 3331;3331A;3331AK;SA50516110/11	8 PK 1215 TM
				HYD-P	OE-NO.: 5419972892; MOD: 3331;3331A;3331AK;SA50516901	8 PK 1215 TM
				HYD-P	OE-NO.: 5419972892; MOD: 3331;3331A;3331AK;SA59902001/02	8 PK 1215 TM
				W-P	OE-NO.: 5419970992; MOD: 3331;3331A;3331AK;SA50516102	9 PK 2835 TM
				W-P	OE-NO.: 5419971092; MOD: 3331;3331A;3331AK;SA50516103	9 PK 2295 TM
				ALT; AC-C; PS		KT 7004
		OM 541.920;OM 541.940		ALT	OE-NO.: 5419972692; MOD: 3331;3331A;3331AK;SA50516110	11 PK 1890 TM
				ALT	OE-NO.: 5419972692; MOD: 3331;3331A;3331AK;SA50516901	11 PK 1890 TM
				ALT	OE-NO.: 5419972692; MOD: 3331;3331A;3331AK;SA59902001/02	11 PK 1890 TM
				ALT	OE-NO.: 5419972792; MOD: 3331;3331A;3331AK;SA50516111	11 PK 2835 TM
				ALT	OE-NO.: 5419972792; MOD: 3331;3331A;3331AK;SA59902001/02	11 PK 2835 TM
				FAN	OE-NO.: 5419970892; MOD: 3331;3331A;3331AK;SA50516101	9 PK 1888 TM
				FAN	OE-NO.: 5419972592; MOD: 3331;3331A;3331AK;SA50516109	12 PK 1515 TM
				FAN	OE-NO.: 5419973092; MOD: 3331;3331A;3331AK;SA50516115	12 PK 1507 TM
				HYD-P	OE-NO.: 5419972892; MOD: 3331;3331A;3331AK;SA50516110/11	8 PK 1215 TM
				HYD-P	OE-NO.: 5419972892; MOD: 3331;3331A;3331AK;SA50516901	8 PK 1215 TM
				HYD-P	OE-NO.: 5419972892; MOD: 3331;3331A;3331AK;SA59902001/02	8 PK 1215 TM
				W-P	OE-NO.: 5419970992; MOD: 3331;3331A;3331AK;SA50516102	9 PK 2835 TM
				W-P	OE-NO.: 5419971092; MOD: 3331;3331A;3331AK;SA50516103	9 PK 2295 TM
				ALT; AC-C; PS		KT 7004
		OM 541.926		ALT	MTR-CODE: OM541.920; OE-NO.: 5419972692; MOD: 3331;3331A;3331AK;SA50516110	11 PK 1890 TM
				ALT	MTR-CODE: OM541.920; OE-NO.: 5419972692; MOD: 3331;3331A;3331AK;SA50516901	11 PK 1890 TM
				ALT	MTR-CODE: OM541.920; OE-NO.: 5419972692; MOD: 3331;3331A;3331AK;SA59902001/02	11 PK 1890 TM
				ALT	MTR-CODE: OM541.920; OE-NO.: 5419972792; MOD: 3331;3331A;3331AK;SA50516111	11 PK 2835 TM
				ALT	MTR-CODE: OM541.920; OE-NO.: 5419972792; MOD: 3331;3331A;3331AK;SA59902001/02	11 PK 2835 TM
				FAN	MTR-CODE: OM541.920; OE-NO.: 5419970892; MOD: 3331;3331A;3331AK;SA50516101	9 PK 1888 TM
				FAN	MTR-CODE: OM541.920; OE-NO.: 5419972592; MOD: 3331;3331A;3331AK;SA50516109	12 PK 1515 TM
				FAN	MTR-CODE: OM541.920; OE-NO.: 5419973092; MOD: 3331;3331A;3331AK;SA50516115	12 PK 1507 TM
				HYD-P	MTR-CODE: OM541.920; OE-NO.: 5419972892; MOD: 3331;3331A;3331AK;SA50516110/11	8 PK 1215 TM
				HYD-P	MTR-CODE: OM541.920; OE-NO.: 5419972892; MOD: 3331;3331A;3331AK;SA50516901	8 PK 1215 TM
				HYD-P	MTR-CODE: OM541.920; OE-NO.: 5419972892; MOD: 3331;3331A;3331AK;SA59902001/02	8 PK 1215 TM



## MERCEDES-BENZ

### ACTROS

#### 3331

11946 ccm	230 kW	OM 541.926	04.97 - 10.02	W-P	MTR-CODE: OM541.920; OE-NO.: 5419970992; MOD: 3331;3331A;3331AK;SA50516102	9 PK 2835 TM
				W-P	MTR-CODE: OM541.920; OE-NO.: 5419971092; MOD: 3331;3331A;3331AK;SA50516103	9 PK 2295 TM
		OM 541.926;OM 541.941		ALT	MTR-CODE: OM541.920; OE-NO.: 5419972692; MOD: 3331;3331A;3331AK;SA50516110	11 PK 1890 TM
				ALT	MTR-CODE: OM541.920; OE-NO.: 5419972692; MOD: 3331;3331A;3331AK;SA50516901	11 PK 1890 TM
				ALT	MTR-CODE: OM541.920; OE-NO.: 5419972692; MOD: 3331;3331A;3331AK;SA59902001/02	11 PK 1890 TM
				ALT	MTR-CODE: OM541.920; OE-NO.: 5419972792; MOD: 3331;3331A;3331AK;SA50516111	11 PK 2835 TM
				ALT	MTR-CODE: OM541.920; OE-NO.: 5419972792; MOD: 3331;3331A;3331AK;SA59902001/02	11 PK 2835 TM
				FAN	MTR-CODE: OM541.920; OE-NO.: 5419970892; MOD: 3331;3331A;3331AK;SA50516101	9 PK 1888 TM
				FAN	MTR-CODE: OM541.920; OE-NO.: 5419972592; MOD: 3331;3331A;3331AK;SA50516109	12 PK 1515 TM
				FAN	MTR-CODE: OM541.920; OE-NO.: 5419973092; MOD: 3331;3331A;3331AK;SA50516115	12 PK 1507 TM
				HYD-P	MTR-CODE: OM541.920; OE-NO.: 5419972892; MOD: 3331;3331A;3331AK;SA50516110/11	8 PK 1215 TM
				HYD-P	MTR-CODE: OM541.920; OE-NO.: 5419972892; MOD: 3331;3331A;3331AK;SA50516901	8 PK 1215 TM
				HYD-P	MTR-CODE: OM541.920; OE-NO.: 5419972892; MOD: 3331;3331A;3331AK;SA59902001/02	8 PK 1215 TM
				W-P	MTR-CODE: OM541.920; OE-NO.: 5419970992; MOD: 3331;3331A;3331AK;SA50516102	9 PK 2835 TM
				W-P	MTR-CODE: OM541.920; OE-NO.: 5419971092; MOD: 3331;3331A;3331AK;SA50516103	9 PK 2295 TM

#### 3335

11946 ccm	260 kW	OM 541.922	04.97 - 10.03	ALT	MTR-CODE: OM541.920; OE-NO.: 5419972692; MOD: 3331;3331A;3331AK;SA50516110	11 PK 1890 TM
				ALT	MTR-CODE: OM541.920; OE-NO.: 5419972692; MOD: 3331;3331A;3331AK;SA50516901	11 PK 1890 TM
				ALT	MTR-CODE: OM541.920; OE-NO.: 5419972692; MOD: 3331;3331A;3331AK;SA59902001/02	11 PK 1890 TM
				ALT	MTR-CODE: OM541.920; OE-NO.: 5419972792; MOD: 3331;3331A;3331AK;SA50516111	11 PK 2835 TM
				ALT	MTR-CODE: OM541.920; OE-NO.: 5419972792; MOD: 3331;3331A;3331AK;SA59902001/02	11 PK 2835 TM
				FAN	MTR-CODE: OM541.920; OE-NO.: 5419970892; MOD: 3331;3331A;3331AK;SA50516101	9 PK 1888 TM
				FAN	MTR-CODE: OM541.920; OE-NO.: 5419972592; MOD: 3331;3331A;3331AK;SA50516109	12 PK 1515 TM
				FAN	MTR-CODE: OM541.920; OE-NO.: 5419973092; MOD: 3331;3331A;3331AK;SA50516115	12 PK 1507 TM
				HYD-P	MTR-CODE: OM541.920; OE-NO.: 5419972892; MOD: 3331;3331A;3331AK;SA50516110/11	8 PK 1215 TM
				HYD-P	MTR-CODE: OM541.920; OE-NO.: 5419972892; MOD: 3331;3331A;3331AK;SA50516901	8 PK 1215 TM
				HYD-P	MTR-CODE: OM541.920; OE-NO.: 5419972892; MOD: 3331;3331A;3331AK;SA59902001/02	8 PK 1215 TM
				W-P	MTR-CODE: OM541.920; OE-NO.: 5419970992; MOD: 3331;3331A;3331AK;SA50516102	9 PK 2835 TM
				W-P	MTR-CODE: OM541.920; OE-NO.: 5419971092; MOD: 3331;3331A;3331AK;SA50516103	9 PK 2295 TM
				ALT; AC-C	MTR-CODE: OM 541.920	KT 7004
		OM 541.922;OM 541.942		ALT	MTR-CODE: OM541.920; OE-NO.: 5419972692; MOD: 3331;3331A;3331AK;SA50516110	11 PK 1890 TM
				ALT	MTR-CODE: OM541.920; OE-NO.: 5419972692; MOD: 3331;3331A;3331AK;SA50516901	11 PK 1890 TM
				ALT	MTR-CODE: OM541.920; OE-NO.: 5419972692; MOD: 3331;3331A;3331AK;SA59902001/02	11 PK 1890 TM
				ALT	MTR-CODE: OM541.920; OE-NO.: 5419972792; MOD: 3331;3331A;3331AK;SA50516111	11 PK 2835 TM
				ALT	MTR-CODE: OM541.920; OE-NO.: 5419972792; MOD: 3331;3331A;3331AK;SA59902001/02	11 PK 2835 TM
				FAN	MTR-CODE: OM541.920; OE-NO.: 5419970892; MOD: 3331;3331A;3331AK;SA50516101	9 PK 1888 TM
				FAN	MTR-CODE: OM541.920; OE-NO.: 5419972592; MOD: 3331;3331A;3331AK;SA50516109	12 PK 1515 TM
				FAN	MTR-CODE: OM541.920; OE-NO.: 5419973092; MOD: 3331;3331A;3331AK;SA50516115	12 PK 1507 TM

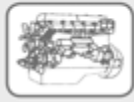

## MERCEDES-BENZ

### ACTROS

#### 3335

11946 ccm	260 kW	OM 541.922;OM 541.942	04.97 - 10.03	HYD-P	MTR-CODE: OM541.920; OE-NO.: 5419972892; MOD: 3331;3331A;3331AK;SA50516110/11	<b>8 PK 1215 TM</b>
				HYD-P	MTR-CODE: OM541.920; OE-NO.: 5419972892; MOD: 3331;3331A;3331AK;SA50516901	<b>8 PK 1215 TM</b>
				HYD-P	MTR-CODE: OM541.920; OE-NO.: 5419972892; MOD: 3331;3331A;3331AK;SA59902001/02	<b>8 PK 1215 TM</b>
				W-P	MTR-CODE: OM541.920; OE-NO.: 5419970992; MOD: 3331;3331A;3331AK;SA50516102	<b>9 PK 2835 TM</b>
				W-P	MTR-CODE: OM541.920; OE-NO.: 5419971092; MOD: 3331;3331A;3331AK;SA50516103	<b>9 PK 2295 TM</b>
				ALT; AC-C	MTR-CODE: OM 541.920	<b>KT 7004</b>

#### 3340

11946 ccm	290 kW	OM 541.923	04.97 - 10.02	ALT	MTR-CODE: OM541.920; OE-NO.: 5419972692; MOD: 3331;3331A;3331AK;SA50516110	<b>11 PK 1890 TM</b>
				ALT	MTR-CODE: OM541.920; OE-NO.: 5419972692; MOD: 3331;3331A;3331AK;SA50516901	<b>11 PK 1890 TM</b>
				ALT	MTR-CODE: OM541.920; OE-NO.: 5419972692; MOD: 3331;3331A;3331AK;SA59902001/02	<b>11 PK 1890 TM</b>
				ALT	MTR-CODE: OM541.920; OE-NO.: 5419972792; MOD: 3331;3331A;3331AK;SA50516111	<b>11 PK 2835 TM</b>
				ALT	MTR-CODE: OM541.920; OE-NO.: 5419972792; MOD: 3331;3331A;3331AK;SA59902001/02	<b>11 PK 2835 TM</b>
				FAN	MTR-CODE: OM541.920; OE-NO.: 5419970892; MOD: 3331;3331A;3331AK;SA50516101	<b>9 PK 1888 TM</b>
				FAN	MTR-CODE: OM541.920; OE-NO.: 5419972592; MOD: 3331;3331A;3331AK;SA50516109	<b>12 PK 1515 TM</b>
				FAN	MTR-CODE: OM541.920; OE-NO.: 5419973092; MOD: 3331;3331A;3331AK;SA50516115	<b>12 PK 1507 TM</b>
				HYD-P	MTR-CODE: OM541.920; OE-NO.: 5419972892; MOD: 3331;3331A;3331AK;SA50516110/11	<b>8 PK 1215 TM</b>
				HYD-P	MTR-CODE: OM541.920; OE-NO.: 5419972892; MOD: 3331;3331A;3331AK;SA50516901	<b>8 PK 1215 TM</b>
				HYD-P	MTR-CODE: OM541.920; OE-NO.: 5419972892; MOD: 3331;3331A;3331AK;SA59902001/02	<b>8 PK 1215 TM</b>
				W-P	MTR-CODE: OM541.920; OE-NO.: 5419970992; MOD: 3331;3331A;3331AK;SA50516102	<b>9 PK 2835 TM</b>
				W-P	MTR-CODE: OM541.920; OE-NO.: 5419971092; MOD: 3331;3331A;3331AK;SA50516103	<b>9 PK 2295 TM</b>
				ALT; AC-C	MTR-CODE: OM 541.920	<b>KT 7004</b>
		OM 541.923;OM 541.944		ALT	MTR-CODE: OM541.920; OE-NO.: 5419972692; MOD: 3331;3331A;3331AK;SA50516110	<b>11 PK 1890 TM</b>
				ALT	MTR-CODE: OM541.920; OE-NO.: 5419972692; MOD: 3331;3331A;3331AK;SA50516901	<b>11 PK 1890 TM</b>
				ALT	MTR-CODE: OM541.920; OE-NO.: 5419972692; MOD: 3331;3331A;3331AK;SA59902001/02	<b>11 PK 1890 TM</b>
				ALT	MTR-CODE: OM541.920; OE-NO.: 5419972792; MOD: 3331;3331A;3331AK;SA50516111	<b>11 PK 2835 TM</b>
				ALT	MTR-CODE: OM541.920; OE-NO.: 5419972792; MOD: 3331;3331A;3331AK;SA59902001/02	<b>11 PK 2835 TM</b>
				FAN	MTR-CODE: OM541.920; OE-NO.: 5419970892; MOD: 3331;3331A;3331AK;SA50516101	<b>9 PK 1888 TM</b>
				FAN	MTR-CODE: OM541.920; OE-NO.: 5419972592; MOD: 3331;3331A;3331AK;SA50516109	<b>12 PK 1515 TM</b>
				FAN	MTR-CODE: OM541.920; OE-NO.: 5419973092; MOD: 3331;3331A;3331AK;SA50516115	<b>12 PK 1507 TM</b>
				HYD-P	MTR-CODE: OM541.920; OE-NO.: 5419972892; MOD: 3331;3331A;3331AK;SA50516110/11	<b>8 PK 1215 TM</b>
				HYD-P	MTR-CODE: OM541.920; OE-NO.: 5419972892; MOD: 3331;3331A;3331AK;SA50516901	<b>8 PK 1215 TM</b>
				HYD-P	MTR-CODE: OM541.920; OE-NO.: 5419972892; MOD: 3331;3331A;3331AK;SA59902001/02	<b>8 PK 1215 TM</b>
				W-P	MTR-CODE: OM541.920; OE-NO.: 5419970992; MOD: 3331;3331A;3331AK;SA50516102	<b>9 PK 2835 TM</b>
				W-P	MTR-CODE: OM541.920; OE-NO.: 5419971092; MOD: 3331;3331A;3331AK;SA50516103	<b>9 PK 2295 TM</b>
				ALT; AC-C	MTR-CODE: OM 541.920	<b>KT 7004</b>
		OM 541.924		ALT	MTR-CODE: OM541.920; OE-NO.: 5419972692; MOD: 3331;3331A;3331AK;SA50516110	<b>11 PK 1890 TM</b>
				ALT	MTR-CODE: OM541.920; OE-NO.: 5419972692; MOD: 3331;3331A;3331AK;SA50516901	<b>11 PK 1890 TM</b>
				ALT	MTR-CODE: OM541.920; OE-NO.: 5419972692; MOD: 3331;3331A;3331AK;SA59902001/02	<b>11 PK 1890 TM</b>
				ALT	MTR-CODE: OM541.920; OE-NO.: 5419972792; MOD: 3331;3331A;3331AK;SA50516111	<b>11 PK 2835 TM</b>

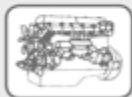

## MERCEDES-BENZ

### ACTROS

#### 3340

11946 ccm	290 kW	OM 541.924	04.97 - 10.02	ALT	MTR-CODE: OM541.920; OE-NO.: 5419972792; MOD: 3331;3331A;3331AK;SA59902001/02	11 PK 2835 TM
				FAN	MTR-CODE: OM541.920; OE-NO.: 5419970892; MOD: 3331;3331A;3331AK;SA50516101	9 PK 1888 TM
				FAN	MTR-CODE: OM541.920; OE-NO.: 5419972592; MOD: 3331;3331A;3331AK;SA50516109	12 PK 1515 TM
				FAN	MTR-CODE: OM541.920; OE-NO.: 5419973092; MOD: 3331;3331A;3331AK;SA50516115	12 PK 1507 TM
				HYD-P	MTR-CODE: OM541.920; OE-NO.: 5419972892; MOD: 3331;3331A;3331AK;SA50516110/11	8 PK 1215 TM
				HYD-P	MTR-CODE: OM541.920; OE-NO.: 5419972892; MOD: 3331;3331A;3331AK;SA50516901	8 PK 1215 TM
				HYD-P	MTR-CODE: OM541.920; OE-NO.: 5419972892; MOD: 3331;3331A;3331AK;SA59902001/02	8 PK 1215 TM
				W-P	MTR-CODE: OM541.920; OE-NO.: 5419970992; MOD: 3331;3331A;3331AK;SA50516102	9 PK 2835 TM
				W-P	MTR-CODE: OM541.920; OE-NO.: 5419971092; MOD: 3331;3331A;3331AK;SA50516103	9 PK 2295 TM
				ALT; AC-C	MTR-CODE: OM 541.920	KT 7004
		OM 541.924;OM 541.945		ALT	MTR-CODE: OM541.920; OE-NO.: 5419972692; MOD: 3331;3331A;3331AK;SA50516110	11 PK 1890 TM
				ALT	MTR-CODE: OM541.920; OE-NO.: 5419972692; MOD: 3331;3331A;3331AK;SA50516901	11 PK 1890 TM
				ALT	MTR-CODE: OM541.920; OE-NO.: 5419972692; MOD: 3331;3331A;3331AK;SA59902001/02	11 PK 1890 TM
				ALT	MTR-CODE: OM541.920; OE-NO.: 5419972792; MOD: 3331;3331A;3331AK;SA50516111	11 PK 2835 TM
				ALT	MTR-CODE: OM541.920; OE-NO.: 5419972792; MOD: 3331;3331A;3331AK;SA59902001/02	11 PK 2835 TM
				FAN	MTR-CODE: OM541.920; OE-NO.: 5419970892; MOD: 3331;3331A;3331AK;SA50516101	9 PK 1888 TM
				FAN	MTR-CODE: OM541.920; OE-NO.: 5419972592; MOD: 3331;3331A;3331AK;SA50516109	12 PK 1515 TM
				FAN	MTR-CODE: OM541.920; OE-NO.: 5419973092; MOD: 3331;3331A;3331AK;SA50516115	12 PK 1507 TM
				HYD-P	MTR-CODE: OM541.920; OE-NO.: 5419972892; MOD: 3331;3331A;3331AK;SA50516110/11	8 PK 1215 TM
				HYD-P	MTR-CODE: OM541.920; OE-NO.: 5419972892; MOD: 3331;3331A;3331AK;SA50516901	8 PK 1215 TM
				HYD-P	MTR-CODE: OM541.920; OE-NO.: 5419972892; MOD: 3331;3331A;3331AK;SA59902001/02	8 PK 1215 TM
				W-P	MTR-CODE: OM541.920; OE-NO.: 5419970992; MOD: 3331;3331A;3331AK;SA50516102	9 PK 2835 TM
				W-P	MTR-CODE: OM541.920; OE-NO.: 5419971092; MOD: 3331;3331A;3331AK;SA50516103	9 PK 2295 TM
				ALT; AC-C	MTR-CODE: OM 541.920	KT 7004

#### 3343

11946 ccm	315 kW	OM 541.921;OM 541.947	04.97 - 10.02	ALT	MTR-CODE: OM541.920; OE-NO.: 5419972692; MOD: 3331;3331A;3331AK;SA50516110	11 PK 1890 TM
				ALT	MTR-CODE: OM541.920; OE-NO.: 5419972692; MOD: 3331;3331A;3331AK;SA50516901	11 PK 1890 TM
				ALT	MTR-CODE: OM541.920; OE-NO.: 5419972692; MOD: 3331;3331A;3331AK;SA59902001/02	11 PK 1890 TM
				ALT	MTR-CODE: OM541.920; OE-NO.: 5419972792; MOD: 3331;3331A;3331AK;SA50516111	11 PK 2835 TM
				ALT	MTR-CODE: OM541.920; OE-NO.: 5419972792; MOD: 3331;3331A;3331AK;SA59902001/02	11 PK 2835 TM
				FAN	MTR-CODE: OM541.920; OE-NO.: 5419970892; MOD: 3331;3331A;3331AK;SA50516101	9 PK 1888 TM
				FAN	MTR-CODE: OM541.920; OE-NO.: 5419972592; MOD: 3331;3331A;3331AK;SA50516109	12 PK 1515 TM
				FAN	MTR-CODE: OM541.920; OE-NO.: 5419973092; MOD: 3331;3331A;3331AK;SA50516115	12 PK 1507 TM
				HYD-P	MTR-CODE: OM541.920; OE-NO.: 5419972892; MOD: 3331;3331A;3331AK;SA50516110/11	8 PK 1215 TM
				HYD-P	MTR-CODE: OM541.920; OE-NO.: 5419972892; MOD: 3331;3331A;3331AK;SA50516901	8 PK 1215 TM
				HYD-P	MTR-CODE: OM541.920; OE-NO.: 5419972892; MOD: 3331;3331A;3331AK;SA59902001/02	8 PK 1215 TM
				W-P	MTR-CODE: OM541.920; OE-NO.: 5419970992; MOD: 3331;3331A;3331AK;SA50516102	9 PK 2835 TM
				W-P	MTR-CODE: OM541.920; OE-NO.: 5419971092; MOD: 3331;3331A;3331AK;SA50516103	9 PK 2295 TM
				ALT; AC-C	MTR-CODE: OM 541.920	KT 7004



## MERCEDES-BENZ

### ACTROS

#### 3343

11946 ccm	315 kW	OM 541.925	04.97 - 10.02	ALT	MTR-CODE: OM541.920; OE-NO.: 5419972692; MOD: 3331;3331A;3331AK;SA50516110	11 PK 1890 TM
				ALT	MTR-CODE: OM541.920; OE-NO.: 5419972692; MOD: 3331;3331A;3331AK;SA50516901	11 PK 1890 TM
				ALT	MTR-CODE: OM541.920; OE-NO.: 5419972692; MOD: 3331;3331A;3331AK;SA59902001/02	11 PK 1890 TM
				ALT	MTR-CODE: OM541.920; OE-NO.: 5419972792; MOD: 3331;3331A;3331AK;SA50516111	11 PK 2835 TM
				ALT	MTR-CODE: OM541.920; OE-NO.: 5419972792; MOD: 3331;3331A;3331AK;SA59902001/02	11 PK 2835 TM
				FAN	MTR-CODE: OM541.920; OE-NO.: 5419970892; MOD: 3331;3331A;3331AK;SA50516101	9 PK 1888 TM
				FAN	MTR-CODE: OM541.920; OE-NO.: 5419972592; MOD: 3331;3331A;3331AK;SA50516109	12 PK 1515 TM
				FAN	MTR-CODE: OM541.920; OE-NO.: 5419973092; MOD: 3331;3331A;3331AK;SA50516115	12 PK 1507 TM
				HYD-P	MTR-CODE: OM541.920; OE-NO.: 5419972892; MOD: 3331;3331A;3331AK;SA50516110/11	8 PK 1215 TM
				HYD-P	MTR-CODE: OM541.920; OE-NO.: 5419972892; MOD: 3331;3331A;3331AK;SA50516901	8 PK 1215 TM
				HYD-P	MTR-CODE: OM541.920; OE-NO.: 5419972892; MOD: 3331;3331A;3331AK;SA59902001/02	8 PK 1215 TM
				W-P	MTR-CODE: OM541.920; OE-NO.: 5419970992; MOD: 3331;3331A;3331AK;SA50516102	9 PK 2835 TM
				W-P	MTR-CODE: OM541.920; OE-NO.: 5419971092; MOD: 3331;3331A;3331AK;SA50516103	9 PK 2295 TM
				ALT; AC-C	MTR-CODE: OM 541.920	KT 7004
		OM 541.925;OM 541.946		ALT	MTR-CODE: OM541.920; OE-NO.: 5419972692; MOD: 3331;3331A;3331AK;SA50516110	11 PK 1890 TM
				ALT	MTR-CODE: OM541.920; OE-NO.: 5419972692; MOD: 3331;3331A;3331AK;SA50516901	11 PK 1890 TM
				ALT	MTR-CODE: OM541.920; OE-NO.: 5419972692; MOD: 3331;3331A;3331AK;SA59902001/02	11 PK 1890 TM
				ALT	MTR-CODE: OM541.920; OE-NO.: 5419972792; MOD: 3331;3331A;3331AK;SA50516111	11 PK 2835 TM
				ALT	MTR-CODE: OM541.920; OE-NO.: 5419972792; MOD: 3331;3331A;3331AK;SA59902001/02	11 PK 2835 TM
				FAN	MTR-CODE: OM541.920; OE-NO.: 5419970892; MOD: 3331;3331A;3331AK;SA50516101	9 PK 1888 TM
				FAN	MTR-CODE: OM541.920; OE-NO.: 5419972592; MOD: 3331;3331A;3331AK;SA50516109	12 PK 1515 TM
				FAN	MTR-CODE: OM541.920; OE-NO.: 5419973092; MOD: 3331;3331A;3331AK;SA50516115	12 PK 1507 TM
				HYD-P	MTR-CODE: OM541.920; OE-NO.: 5419972892; MOD: 3331;3331A;3331AK;SA50516110/11	8 PK 1215 TM
				HYD-P	MTR-CODE: OM541.920; OE-NO.: 5419972892; MOD: 3331;3331A;3331AK;SA50516901	8 PK 1215 TM
				HYD-P	MTR-CODE: OM541.920; OE-NO.: 5419972892; MOD: 3331;3331A;3331AK;SA59902001/02	8 PK 1215 TM
				W-P	MTR-CODE: OM541.920; OE-NO.: 5419970992; MOD: 3331;3331A;3331AK;SA50516102	9 PK 2835 TM
				W-P	MTR-CODE: OM541.920; OE-NO.: 5419971092; MOD: 3331;3331A;3331AK;SA50516103	9 PK 2295 TM
				ALT; AC-C	MTR-CODE: OM 541.920	KT 7004

#### 3348

15928 ccm	350 kW	OM 542.921	04.97 - 10.02	ALT	MTR-CODE: OM542.920; OE-NO.: 5419972692; MOD: 3348;3348AK;SA50516110	11 PK 1890 TM
				ALT	MTR-CODE: OM542.920; OE-NO.: 5419972692; MOD: 3348;3348AK;SA50516901	11 PK 1890 TM
				ALT	MTR-CODE: OM542.920; OE-NO.: 5419972692; MOD: 3348;3348AK;SA59902001/02	11 PK 1890 TM
				ALT	MTR-CODE: OM542.920; OE-NO.: 5419972792; MOD: 3348;3348AK;SA50516111	11 PK 2835 TM
				ALT	MTR-CODE: OM542.920; OE-NO.: 5419972792; MOD: 3348;3348AK;SA59902001/02	11 PK 2835 TM
				FAN	MTR-CODE: OM542.920; OE-NO.: 5419970892; MOD: 3348;3348AK;SA50516101	9 PK 1888 TM
				FAN	MTR-CODE: OM542.920; OE-NO.: 5419972592; MOD: 3348;3348AK;SA50516109	12 PK 1515 TM
				FAN	MTR-CODE: OM542.920; OE-NO.: 5419973092; MOD: 3348;3348AK;SA50516115	12 PK 1507 TM
				HYD-P	MTR-CODE: OM542.920; OE-NO.: 5419972892; MOD: 3348;3348AK;SA50516110/11	8 PK 1215 TM



## MERCEDES-BENZ

### ACTROS

#### 3348

15928 ccm	350 kW	OM 542.921	04.97 - 10.02	HYD-P	MTR-CODE: OM542.920; OE-NO.: 5419972892; MOD: 3348;3348AK;SA50516901	<b>8 PK 1215 TM</b>
				HYD-P	MTR-CODE: OM542.920; OE-NO.: 5419972892; MOD: 3348;3348AK;SA59902001/02	<b>8 PK 1215 TM</b>
				W-P	MTR-CODE: OM542.920; OE-NO.: 5419970992; MOD: 3348;3348AK;SA50516102	<b>9 PK 2835 TM</b>
				W-P	MTR-CODE: OM542.920; OE-NO.: 5419971092; MOD: 3348;3348AK;SA50516103	<b>9 PK 2295 TM</b>
		OM 542.921;OM 542.940		ALT; AC-C	MTR-CODE: OM 541.920	<b>KT 7004</b>
				ALT	MTR-CODE: OM542.920; OE-NO.: 5419972692; MOD: 3348;3348AK;SA50516110	<b>11 PK 1890 TM</b>
				ALT	MTR-CODE: OM542.920; OE-NO.: 5419972692; MOD: 3348;3348AK;SA50516901	<b>11 PK 1890 TM</b>
				ALT	MTR-CODE: OM542.920; OE-NO.: 5419972692; MOD: 3348;3348AK;SA59902001/02	<b>11 PK 1890 TM</b>
				ALT	MTR-CODE: OM542.920; OE-NO.: 5419972792; MOD: 3348;3348AK;SA50516111	<b>11 PK 2835 TM</b>
				ALT	MTR-CODE: OM542.920; OE-NO.: 5419972792; MOD: 3348;3348AK;SA59902001/02	<b>11 PK 2835 TM</b>
				FAN	MTR-CODE: OM542.920; OE-NO.: 5419970892; MOD: 3348;3348AK;SA50516101	<b>9 PK 1888 TM</b>
				FAN	MTR-CODE: OM542.920; OE-NO.: 5419972592; MOD: 3348;3348AK;SA50516109	<b>12 PK 1515 TM</b>
				FAN	MTR-CODE: OM542.920; OE-NO.: 5419973092; MOD: 3348;3348AK;SA50516115	<b>12 PK 1507 TM</b>
				HYD-P	MTR-CODE: OM542.920; OE-NO.: 5419972892; MOD: 3348;3348AK;SA50516110/11	<b>8 PK 1215 TM</b>
				HYD-P	MTR-CODE: OM542.920; OE-NO.: 5419972892; MOD: 3348;3348AK;SA50516901	<b>8 PK 1215 TM</b>
				HYD-P	MTR-CODE: OM542.920; OE-NO.: 5419972892; MOD: 3348;3348AK;SA59902001/02	<b>8 PK 1215 TM</b>
				W-P	MTR-CODE: OM542.920; OE-NO.: 5419970992; MOD: 3348;3348AK;SA50516102	<b>9 PK 2835 TM</b>
				W-P	MTR-CODE: OM542.920; OE-NO.: 5419971092; MOD: 3348;3348AK;SA50516103	<b>9 PK 2295 TM</b>
		OM 542.925		ALT; AC-C	MTR-CODE: OM 541.920	<b>KT 7004</b>
				ALT	MTR-CODE: OM542.920; OE-NO.: 5419972692; MOD: 3348;3348AK;SA50516110	<b>11 PK 1890 TM</b>
				ALT	MTR-CODE: OM542.920; OE-NO.: 5419972692; MOD: 3348;3348AK;SA50516901	<b>11 PK 1890 TM</b>
				ALT	MTR-CODE: OM542.920; OE-NO.: 5419972692; MOD: 3348;3348AK;SA59902001/02	<b>11 PK 1890 TM</b>
				ALT	MTR-CODE: OM542.920; OE-NO.: 5419972792; MOD: 3348;3348AK;SA50516111	<b>11 PK 2835 TM</b>
				ALT	MTR-CODE: OM542.920; OE-NO.: 5419972792; MOD: 3348;3348AK;SA59902001/02	<b>11 PK 2835 TM</b>
				FAN	MTR-CODE: OM542.920; OE-NO.: 5419970892; MOD: 3348;3348AK;SA50516101	<b>9 PK 1888 TM</b>
				FAN	MTR-CODE: OM542.920; OE-NO.: 5419972592; MOD: 3348;3348AK;SA50516109	<b>12 PK 1515 TM</b>
				FAN	MTR-CODE: OM542.920; OE-NO.: 5419973092; MOD: 3348;3348AK;SA50516115	<b>12 PK 1507 TM</b>
				HYD-P	MTR-CODE: OM542.920; OE-NO.: 5419972892; MOD: 3348;3348AK;SA50516110/11	<b>8 PK 1215 TM</b>
				HYD-P	MTR-CODE: OM542.920; OE-NO.: 5419972892; MOD: 3348;3348AK;SA50516901	<b>8 PK 1215 TM</b>
				HYD-P	MTR-CODE: OM542.920; OE-NO.: 5419972892; MOD: 3348;3348AK;SA59902001/02	<b>8 PK 1215 TM</b>
				W-P	MTR-CODE: OM542.920; OE-NO.: 5419970992; MOD: 3348;3348AK;SA50516102	<b>9 PK 2835 TM</b>
				W-P	MTR-CODE: OM542.920; OE-NO.: 5419971092; MOD: 3348;3348AK;SA50516103	<b>9 PK 2295 TM</b>
				ALT; AC-C	MTR-CODE: OM 541.920	<b>KT 7004</b>

#### 3353

15928 ccm	390 kW	OM 542.920	04.97 - 10.02	ALT	OE-NO.: 5419972692; MOD: 3348;3348AK;SA50516110	<b>11 PK 1890 TM</b>
				ALT	OE-NO.: 5419972692; MOD: 3348;3348AK;SA50516901	<b>11 PK 1890 TM</b>
				ALT	OE-NO.: 5419972692; MOD: 3348;3348AK;SA59902001/02	<b>11 PK 1890 TM</b>
				ALT	OE-NO.: 5419972792; MOD: 3348;3348AK;SA50516111	<b>11 PK 2835 TM</b>
				ALT	OE-NO.: 5419972792; MOD: 3348;3348AK;SA59902001/02	<b>11 PK 2835 TM</b>

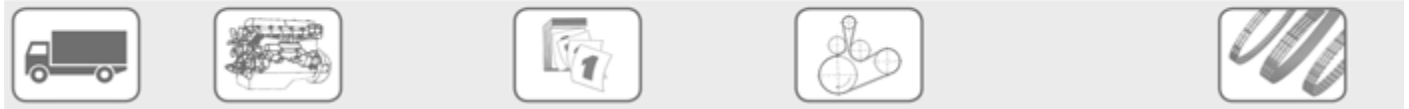

## MERCEDES-BENZ

### ACTROS

#### 3353

15928 ccm	390 kW	OM 542.920	04.97 - 10.02	FAN	OE-NO.: 5419970892; MOD: 3348;3348AK;SA50516101	9 PK 1888 TM
				FAN	OE-NO.: 5419972592; MOD: 3348;3348AK;SA50516109	12 PK 1515 TM
				FAN	OE-NO.: 5419973092; MOD: 3348;3348AK;SA50516115	12 PK 1507 TM
				HYD-P	OE-NO.: 5419972892; MOD: 3348;3348AK;SA50516110/11	8 PK 1215 TM
				HYD-P	OE-NO.: 5419972892; MOD: 3348;3348AK;SA50516901	8 PK 1215 TM
				HYD-P	OE-NO.: 5419972892; MOD: 3348;3348AK;SA59902001/02	8 PK 1215 TM
				W-P	OE-NO.: 5419970992; MOD: 3348;3348AK;SA50516102	9 PK 2835 TM
				W-P	OE-NO.: 5419971092; MOD: 3348;3348AK;SA50516103	9 PK 2295 TM
				ALT; AC-C	MTR-CODE: OM 541.920	KT 7004
		OM 542.920;OM 542.926;OM 542.943		ALT	OE-NO.: 5419972692; MOD: 3348;3348AK;SA50516110	11 PK 1890 TM
				ALT	OE-NO.: 5419972692; MOD: 3348;3348AK;SA50516901	11 PK 1890 TM
				ALT	OE-NO.: 5419972692; MOD: 3348;3348AK;SA59902001/02	11 PK 1890 TM
				ALT	OE-NO.: 5419972792; MOD: 3348;3348AK;SA50516111	11 PK 2835 TM
				ALT	OE-NO.: 5419972792; MOD: 3348;3348AK;SA59902001/02	11 PK 2835 TM
				FAN	OE-NO.: 5419970892; MOD: 3348;3348AK;SA50516101	9 PK 1888 TM
				FAN	OE-NO.: 5419972592; MOD: 3348;3348AK;SA50516109	12 PK 1515 TM
				FAN	OE-NO.: 5419973092; MOD: 3348;3348AK;SA50516115	12 PK 1507 TM
				HYD-P	OE-NO.: 5419972892; MOD: 3348;3348AK;SA50516110/11	8 PK 1215 TM
				HYD-P	OE-NO.: 5419972892; MOD: 3348;3348AK;SA50516901	8 PK 1215 TM
				HYD-P	OE-NO.: 5419972892; MOD: 3348;3348AK;SA59902001/02	8 PK 1215 TM
				W-P	OE-NO.: 5419970992; MOD: 3348;3348AK;SA50516102	9 PK 2835 TM
				W-P	OE-NO.: 5419971092; MOD: 3348;3348AK;SA50516103	9 PK 2295 TM
				ALT; AC-C	MTR-CODE: OM 541.920	KT 7004
		OM 542.920;OM 542.942		ALT	OE-NO.: 5419972692; MOD: 3348;3348AK;SA50516110	11 PK 1890 TM
				ALT	OE-NO.: 5419972692; MOD: 3348;3348AK;SA50516901	11 PK 1890 TM
				ALT	OE-NO.: 5419972692; MOD: 3348;3348AK;SA59902001/02	11 PK 1890 TM
				ALT	OE-NO.: 5419972792; MOD: 3348;3348AK;SA50516111	11 PK 2835 TM
				ALT	OE-NO.: 5419972792; MOD: 3348;3348AK;SA59902001/02	11 PK 2835 TM
				FAN	OE-NO.: 5419970892; MOD: 3348;3348AK;SA50516101	9 PK 1888 TM
				FAN	OE-NO.: 5419972592; MOD: 3348;3348AK;SA50516109	12 PK 1515 TM
				FAN	OE-NO.: 5419973092; MOD: 3348;3348AK;SA50516115	12 PK 1507 TM
				HYD-P	OE-NO.: 5419972892; MOD: 3348;3348AK;SA50516110/11	8 PK 1215 TM
				HYD-P	OE-NO.: 5419972892; MOD: 3348;3348AK;SA50516901	8 PK 1215 TM
				HYD-P	OE-NO.: 5419972892; MOD: 3348;3348AK;SA59902001/02	8 PK 1215 TM
				W-P	OE-NO.: 5419970992; MOD: 3348;3348AK;SA50516102	9 PK 2835 TM
				W-P	OE-NO.: 5419971092; MOD: 3348;3348AK;SA50516103	9 PK 2295 TM
				ALT; AC-C	MTR-CODE: OM 541.920	KT 7004

#### 3357

15928 ccm	420 kW	OM 542.922	04.97 - 10.02	ALT	MTR-CODE: OM542.920; OE-NO.: 5419972692; MOD: 3348;3348AK;SA50516110	11 PK 1890 TM
-----------	--------	------------	---------------	-----	--	---------------



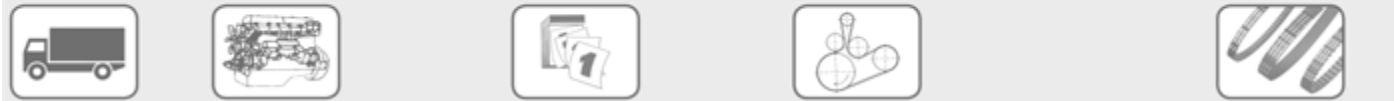

## MERCEDES-BENZ

### ACTROS

#### 3357

15928 ccm	420 kW	OM 542.922	04.97 - 10.02	ALT	MTR-CODE: OM542.920; OE-NO.: 5419972692; MOD: 3348;3348AK;SA50516901	11 PK 1890 TM
				ALT	MTR-CODE: OM542.920; OE-NO.: 5419972692; MOD: 3348;3348AK;SA59902001/02	11 PK 1890 TM
				ALT	MTR-CODE: OM542.920; OE-NO.: 5419972792; MOD: 3348;3348AK;SA50516111	11 PK 2835 TM
				ALT	MTR-CODE: OM542.920; OE-NO.: 5419972792; MOD: 3348;3348AK;SA59902001/02	11 PK 2835 TM
				FAN	MTR-CODE: OM542.920; OE-NO.: 5419970892; MOD: 3348;3348AK;SA50516101	9 PK 1888 TM
				FAN	MTR-CODE: OM542.920; OE-NO.: 5419972592; MOD: 3348;3348AK;SA50516109	12 PK 1515 TM
				FAN	MTR-CODE: OM542.920; OE-NO.: 5419973092; MOD: 3348;3348AK;SA50516115	12 PK 1507 TM
				HYD-P	MTR-CODE: OM542.920; OE-NO.: 5419972892; MOD: 3348;3348AK;SA50516110/11	8 PK 1215 TM
				HYD-P	MTR-CODE: OM542.920; OE-NO.: 5419972892; MOD: 3348;3348AK;SA50516901	8 PK 1215 TM
				HYD-P	MTR-CODE: OM542.920; OE-NO.: 5419972892; MOD: 3348;3348AK;SA59902001/02	8 PK 1215 TM
				W-P	MTR-CODE: OM542.920; OE-NO.: 5419970992; MOD: 3348;3348AK;SA50516102	9 PK 2835 TM
				W-P	MTR-CODE: OM542.920; OE-NO.: 5419971092; MOD: 3348;3348AK;SA50516103	9 PK 2295 TM
				ALT; AC-C	MTR-CODE: OM 541.920	KT 7004
		OM 542.922;OM 542.944		ALT	MTR-CODE: OM542.920; OE-NO.: 5419972692; MOD: 3348;3348AK;SA50516110	11 PK 1890 TM
				ALT	MTR-CODE: OM542.920; OE-NO.: 5419972692; MOD: 3348;3348AK;SA50516901	11 PK 1890 TM
				ALT	MTR-CODE: OM542.920; OE-NO.: 5419972692; MOD: 3348;3348AK;SA59902001/02	11 PK 1890 TM
				ALT	MTR-CODE: OM542.920; OE-NO.: 5419972792; MOD: 3348;3348AK;SA50516111	11 PK 2835 TM
				ALT	MTR-CODE: OM542.920; OE-NO.: 5419972792; MOD: 3348;3348AK;SA59902001/02	11 PK 2835 TM
				FAN	MTR-CODE: OM542.920; OE-NO.: 5419970892; MOD: 3348;3348AK;SA50516101	9 PK 1888 TM
				FAN	MTR-CODE: OM542.920; OE-NO.: 5419972592; MOD: 3348;3348AK;SA50516109	12 PK 1515 TM
				FAN	MTR-CODE: OM542.920; OE-NO.: 5419973092; MOD: 3348;3348AK;SA50516115	12 PK 1507 TM
				HYD-P	MTR-CODE: OM542.920; OE-NO.: 5419972892; MOD: 3348;3348AK;SA50516110/11	8 PK 1215 TM
				HYD-P	MTR-CODE: OM542.920; OE-NO.: 5419972892; MOD: 3348;3348AK;SA50516901	8 PK 1215 TM
				HYD-P	MTR-CODE: OM542.920; OE-NO.: 5419972892; MOD: 3348;3348AK;SA59902001/02	8 PK 1215 TM
				W-P	MTR-CODE: OM542.920; OE-NO.: 5419970992; MOD: 3348;3348AK;SA50516102	9 PK 2835 TM
				W-P	MTR-CODE: OM542.920; OE-NO.: 5419971092; MOD: 3348;3348AK;SA50516103	9 PK 2295 TM
				ALT; AC-C	MTR-CODE: OM 541.920	KT 7004

#### 4140

11946 ccm	290 kW	OM 541.923;OM 541.944	04.97 - 10.02	ALT	MTR-CODE: OM541.921; OE-NO.: 5419972692; MOD: 4140AK;4140B;SA50516110	11 PK 1890 TM
				ALT	MTR-CODE: OM541.921; OE-NO.: 5419972692; MOD: 4140AK;4140B;SA50516901	11 PK 1890 TM
				ALT	MTR-CODE: OM541.921; OE-NO.: 5419972692; MOD: 4140AK;4140B;SA59902001/02	11 PK 1890 TM
				ALT	MTR-CODE: OM541.921; OE-NO.: 5419972792; MOD: 4140AK;4140B;SA50516111	11 PK 2835 TM
				ALT	MTR-CODE: OM541.921; OE-NO.: 5419972792; MOD: 4140AK;4140B;SA59902001/02	11 PK 2835 TM
				FAN	MTR-CODE: OM541.921; OE-NO.: 5419970892; MOD: 4140AK;4140B;SA50516101	9 PK 1888 TM
				FAN	MTR-CODE: OM541.921; OE-NO.: 5419972592; MOD: 4140AK;4140B;SA50516109	12 PK 1515 TM
				FAN	MTR-CODE: OM541.921; OE-NO.: 5419973092; MOD: 4140AK;4140B;SA50516115	12 PK 1507 TM
				HYD-P	MTR-CODE: OM541.921; OE-NO.: 5419972892; MOD: 4140AK;4140B;SA50516110/11	8 PK 1215 TM
				HYD-P	MTR-CODE: OM541.921; OE-NO.: 5419972892; MOD: 4140AK;4140B;SA50516901	8 PK 1215 TM

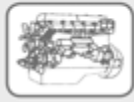

## MERCEDES-BENZ

### ACTROS

#### 4140

11946 ccm	290 kW	OM 541.923;OM 541.944	04.97 - 10.02	HYD-P	MTR-CODE: OM541.921; OE-NO.: 5419972892; MOD: 4140AK;4140B;SA59902001/02	<b>8 PK 1215 TM</b>
				W-P	MTR-CODE: OM541.921; OE-NO.: 5419970992; MOD: 4140AK;4140B;SA50516102	<b>9 PK 2835 TM</b>
				W-P	MTR-CODE: OM541.921; OE-NO.: 5419971092; MOD: 4140AK;4140B;SA50516103	<b>9 PK 2295 TM</b>
				ALT; AC-C	MTR-CODE: OM 541.921	<b>KT 7004</b>
		OM 541.924;OM 541.945		ALT	MTR-CODE: OM541.921; OE-NO.: 5419972692; MOD: 4140AK;4140B;SA50516110	<b>11 PK 1890 TM</b>
				ALT	MTR-CODE: OM541.921; OE-NO.: 5419972692; MOD: 4140AK;4140B;SA50516901	<b>11 PK 1890 TM</b>
				ALT	MTR-CODE: OM541.921; OE-NO.: 5419972692; MOD: 4140AK;4140B;SA59902001/02	<b>11 PK 1890 TM</b>
				ALT	MTR-CODE: OM541.921; OE-NO.: 5419972792; MOD: 4140AK;4140B;SA50516111	<b>11 PK 2835 TM</b>
				ALT	MTR-CODE: OM541.921; OE-NO.: 5419972792; MOD: 4140AK;4140B;SA59902001/02	<b>11 PK 2835 TM</b>
				FAN	MTR-CODE: OM541.921; OE-NO.: 5419970892; MOD: 4140AK;4140B;SA50516101	<b>9 PK 1888 TM</b>
				FAN	MTR-CODE: OM541.921; OE-NO.: 5419972592; MOD: 4140AK;4140B;SA50516109	<b>12 PK 1515 TM</b>
				FAN	MTR-CODE: OM541.921; OE-NO.: 5419973092; MOD: 4140AK;4140B;SA50516115	<b>12 PK 1507 TM</b>
				HYD-P	MTR-CODE: OM541.921; OE-NO.: 5419972892; MOD: 4140AK;4140B;SA50516110/11	<b>8 PK 1215 TM</b>
				HYD-P	MTR-CODE: OM541.921; OE-NO.: 5419972892; MOD: 4140AK;4140B;SA50516901	<b>8 PK 1215 TM</b>
				HYD-P	MTR-CODE: OM541.921; OE-NO.: 5419972892; MOD: 4140AK;4140B;SA59902001/02	<b>8 PK 1215 TM</b>
				W-P	MTR-CODE: OM541.921; OE-NO.: 5419970992; MOD: 4140AK;4140B;SA50516102	<b>9 PK 2835 TM</b>
				W-P	MTR-CODE: OM541.921; OE-NO.: 5419971092; MOD: 4140AK;4140B;SA50516103	<b>9 PK 2295 TM</b>
				ALT; AC-C	MTR-CODE: OM 541.921	<b>KT 7004</b>

#### 4143

11946 ccm	315 kW	OM 541.921;OM 541.947	04.97 - 10.02	ALT	OE-NO.: 5419972692; MOD: 4140AK;4140B;SA50516110	<b>11 PK 1890 TM</b>
				ALT	OE-NO.: 5419972692; MOD: 4140AK;4140B;SA50516901	<b>11 PK 1890 TM</b>
				ALT	OE-NO.: 5419972692; MOD: 4140AK;4140B;SA59902001/02	<b>11 PK 1890 TM</b>
				ALT	OE-NO.: 5419972792; MOD: 4140AK;4140B;SA50516111	<b>11 PK 2835 TM</b>
				ALT	OE-NO.: 5419972792; MOD: 4140AK;4140B;SA59902001/02	<b>11 PK 2835 TM</b>
				FAN	OE-NO.: 5419970892; MOD: 4140AK;4140B;SA50516101	<b>9 PK 1888 TM</b>
				FAN	OE-NO.: 5419972592; MOD: 4140AK;4140B;SA50516109	<b>12 PK 1515 TM</b>
				FAN	OE-NO.: 5419973092; MOD: 4140AK;4140B;SA50516115	<b>12 PK 1507 TM</b>
				HYD-P	OE-NO.: 5419972892; MOD: 4140AK;4140B;SA50516110/11	<b>8 PK 1215 TM</b>
				HYD-P	OE-NO.: 5419972892; MOD: 4140AK;4140B;SA50516901	<b>8 PK 1215 TM</b>
				HYD-P	OE-NO.: 5419972892; MOD: 4140AK;4140B;SA59902001/02	<b>8 PK 1215 TM</b>
				W-P	OE-NO.: 5419970992; MOD: 4140AK;4140B;SA50516102	<b>9 PK 2835 TM</b>
				W-P	OE-NO.: 5419971092; MOD: 4140AK;4140B;SA50516103	<b>9 PK 2295 TM</b>
				ALT; AC-C; PS		<b>KT 7004</b>
		OM 541.925;OM 541.946		ALT	MTR-CODE: OM541.921; OE-NO.: 5419972692; MOD: 4140AK;4140B;SA50516110	<b>11 PK 1890 TM</b>
				ALT	MTR-CODE: OM541.921; OE-NO.: 5419972692; MOD: 4140AK;4140B;SA50516901	<b>11 PK 1890 TM</b>
				ALT	MTR-CODE: OM541.921; OE-NO.: 5419972692; MOD: 4140AK;4140B;SA59902001/02	<b>11 PK 1890 TM</b>
				ALT	MTR-CODE: OM541.921; OE-NO.: 5419972792; MOD: 4140AK;4140B;SA50516111	<b>11 PK 2835 TM</b>
				ALT	MTR-CODE: OM541.921; OE-NO.: 5419972792; MOD: 4140AK;4140B;SA59902001/02	<b>11 PK 2835 TM</b>
				FAN	MTR-CODE: OM541.921; OE-NO.: 5419970892; MOD: 4140AK;4140B;SA50516101	<b>9 PK 1888 TM</b>



## MERCEDES-BENZ

### ACTROS

#### 4143

11946 ccm	315 kW	OM 541.925;OM 541.946	04.97 - 10.02	FAN	MTR-CODE: OM541.921; OE-NO.: 5419972592; MOD: 4140AK;4140B;SA50516109	12 PK 1515 TM
				FAN	MTR-CODE: OM541.921; OE-NO.: 5419973092; MOD: 4140AK;4140B;SA50516115	12 PK 1507 TM
				HYD-P	MTR-CODE: OM541.921; OE-NO.: 5419972892; MOD: 4140AK;4140B;SA50516110/11	8 PK 1215 TM
				HYD-P	MTR-CODE: OM541.921; OE-NO.: 5419972892; MOD: 4140AK;4140B;SA50516901	8 PK 1215 TM
				HYD-P	MTR-CODE: OM541.921; OE-NO.: 5419972892; MOD: 4140AK;4140B;SA59902001/02	8 PK 1215 TM
				W-P	MTR-CODE: OM541.921; OE-NO.: 5419970992; MOD: 4140AK;4140B;SA50516102	9 PK 2835 TM
				W-P	MTR-CODE: OM541.921; OE-NO.: 5419971092; MOD: 4140AK;4140B;SA50516103	9 PK 2295 TM
				ALT; AC-C	MTR-CODE: OM 541.921	KT 7004

#### 4148

15928 ccm	350 kW	OM 542.921	04.97 - 10.02	ALT	OE-NO.: 5419972692; MOD: 4148AK;4148K;SA50516110	11 PK 1890 TM
				ALT	OE-NO.: 5419972692; MOD: 4148AK;4148K;SA50516901	11 PK 1890 TM
				ALT	OE-NO.: 5419972692; MOD: 4148AK;4148K;SA59902001/02	11 PK 1890 TM
				ALT	OE-NO.: 5419972792; MOD: 4148AK;4148K;SA50516111	11 PK 2835 TM
				ALT	OE-NO.: 5419972792; MOD: 4148AK;4148K;SA59902001/02	11 PK 2835 TM
				FAN	OE-NO.: 5419970892; MOD: 4148AK;4148K;SA50516101	9 PK 1888 TM
				FAN	OE-NO.: 5419972592; MOD: 4148AK;4148K;SA50516109	12 PK 1515 TM
				FAN	OE-NO.: 5419973092; MOD: 4148AK;4148K;SA50516115	12 PK 1507 TM
				HYD-P	OE-NO.: 5419972892; MOD: 4148AK;4148K;SA50516110/11	8 PK 1215 TM
				HYD-P	OE-NO.: 5419972892; MOD: 4148AK;4148K;SA50516901	8 PK 1215 TM
				HYD-P	OE-NO.: 5419972892; MOD: 4148AK;4148K;SA59902001/02	8 PK 1215 TM
				W-P	OE-NO.: 5419970992; MOD: 4148AK;4148K;SA50516102	9 PK 2835 TM
				W-P	OE-NO.: 5419971092; MOD: 4148AK;4148K;SA50516103	9 PK 2295 TM
				ALT; AC-C; PS		KT 7004
		OM 542.925		ALT	MTR-CODE: OM542.921; OE-NO.: 5419972692; MOD: 4148AK;4148K;SA50516110	11 PK 1890 TM
				ALT	MTR-CODE: OM542.921; OE-NO.: 5419972692; MOD: 4148AK;4148K;SA50516901	11 PK 1890 TM
				ALT	MTR-CODE: OM542.921; OE-NO.: 5419972692; MOD: 4148AK;4148K;SA59902001/02	11 PK 1890 TM
				ALT	MTR-CODE: OM542.921; OE-NO.: 5419972792; MOD: 4148AK;4148K;SA50516111	11 PK 2835 TM
				ALT	MTR-CODE: OM542.921; OE-NO.: 5419972792; MOD: 4148AK;4148K;SA59902001/02	11 PK 2835 TM
				FAN	MTR-CODE: OM542.921; OE-NO.: 5419970892; MOD: 4148AK;4148K;SA50516101	9 PK 1888 TM
				FAN	MTR-CODE: OM542.921; OE-NO.: 5419972592; MOD: 4148AK;4148K;SA50516109	12 PK 1515 TM
				FAN	MTR-CODE: OM542.921; OE-NO.: 5419973092; MOD: 4148AK;4148K;SA50516115	12 PK 1507 TM
				HYD-P	MTR-CODE: OM542.921; OE-NO.: 5419972892; MOD: 4148AK;4148K;SA50516110/11	8 PK 1215 TM
				HYD-P	MTR-CODE: OM542.921; OE-NO.: 5419972892; MOD: 4148AK;4148K;SA50516901	8 PK 1215 TM
				HYD-P	MTR-CODE: OM542.921; OE-NO.: 5419972892; MOD: 4148AK;4148K;SA59902001/02	8 PK 1215 TM
				W-P	MTR-CODE: OM542.921; OE-NO.: 5419970992; MOD: 4148AK;4148K;SA50516102	9 PK 2835 TM
				W-P	MTR-CODE: OM542.921; OE-NO.: 5419971092; MOD: 4148AK;4148K;SA50516103	9 PK 2295 TM
				ALT; AC-C	MTR-CODE: OM 542.921	KT 7004

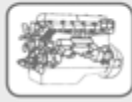

## MERCEDES-BENZ

### ACTROS MP2 / MP3

**1832**

11946 ccm	235 kW	OM 541.940;OM 541.970	04.03 -	ALT	MTR-CODE: OM541.940; OE-NO.: 0009938096; MOD: 1832;1832LS;SA50516119	<b>11 PK 2871 TM</b>
				ALT	MTR-CODE: OM541.940; OE-NO.: 5419972692; MOD: 1832;1832LS;SA50516110	<b>11 PK 1890 TM</b>
				ALT	MTR-CODE: OM541.940; OE-NO.: 5419972692; MOD: 1832;1832LS;SA50516901	<b>11 PK 1890 TM</b>
				ALT	MTR-CODE: OM541.940; OE-NO.: 5419972692; MOD: 1832;1832LS;SA59902001/02	<b>11 PK 1890 TM</b>
				ALT	MTR-CODE: OM541.940; OE-NO.: 5419972792; MOD: 1832;1832LS;SA50516111	<b>11 PK 2835 TM</b>
				ALT	MTR-CODE: OM541.940; OE-NO.: 5419972792; MOD: 1832;1832LS;SA59902001/02	<b>11 PK 2835 TM</b>
				FAN	MTR-CODE: OM541.940; OE-NO.: 0009937796; MOD: 1832;1832LS;SA50516116	<b>9 PK 1920 TM</b>
				FAN	MTR-CODE: OM541.940; OE-NO.: 5419970892; MOD: 1832;1832LS;SA50516101	<b>9 PK 1888 TM</b>
				FAN	MTR-CODE: OM541.940; OE-NO.: 5419972592; MOD: 1832;1832LS;SA50516109	<b>12 PK 1515 TM</b>
				FAN	MTR-CODE: OM541.940; OE-NO.: 5419973092; MOD: 1832;1832LS;SA50516115	<b>12 PK 1507 TM</b>
				HYD-P	MTR-CODE: OM541.940; OE-NO.: 0009938196; MOD: 1832;1832LS;SA50516118/19	<b>8 PK 1202 TM</b>
				HYD-P	MTR-CODE: OM541.940; OE-NO.: 5419972892; MOD: 1832;1832LS;SA50516110/11	<b>8 PK 1215 TM</b>
				HYD-P	MTR-CODE: OM541.940; OE-NO.: 5419972892; MOD: 1832;1832LS;SA50516901	<b>8 PK 1215 TM</b>
				HYD-P	MTR-CODE: OM541.940; OE-NO.: 5419972892; MOD: 1832;1832LS;SA59902001/02	<b>8 PK 1215 TM</b>
				W-P	MTR-CODE: OM541.940; OE-NO.: 0009937896; MOD: 1832;1832LS;SA50516117	<b>9 PK 2871 TM</b>
				W-P	MTR-CODE: OM541.940; OE-NO.: 5419970992; MOD: 1832;1832LS;SA50516102	<b>9 PK 2835 TM</b>
				W-P	MTR-CODE: OM541.940; OE-NO.: 5419971092; MOD: 1832;1832LS;SA50516103	<b>9 PK 2295 TM</b>
				ALT; AC-C	MTR-CODE: OM 541.920	<b>KT 7004</b>
	OM 541.940;OM 541.970;OM 541.996			ALT	MTR-CODE: OM541.940; OE-NO.: 0009938096; MOD: 1832;1832LS;SA50516119	<b>11 PK 2871 TM</b>
				ALT	MTR-CODE: OM541.940; OE-NO.: 5419972692; MOD: 1832;1832LS;SA50516110	<b>11 PK 1890 TM</b>
				ALT	MTR-CODE: OM541.940; OE-NO.: 5419972692; MOD: 1832;1832LS;SA50516901	<b>11 PK 1890 TM</b>
				ALT	MTR-CODE: OM541.940; OE-NO.: 5419972692; MOD: 1832;1832LS;SA59902001/02	<b>11 PK 1890 TM</b>
				ALT	MTR-CODE: OM541.940; OE-NO.: 5419972792; MOD: 1832;1832LS;SA50516111	<b>11 PK 2835 TM</b>
				ALT	MTR-CODE: OM541.940; OE-NO.: 5419972792; MOD: 1832;1832LS;SA59902001/02	<b>11 PK 2835 TM</b>
				FAN	MTR-CODE: OM541.940; OE-NO.: 0009937796; MOD: 1832;1832LS;SA50516116	<b>9 PK 1920 TM</b>
				FAN	MTR-CODE: OM541.940; OE-NO.: 5419970892; MOD: 1832;1832LS;SA50516101	<b>9 PK 1888 TM</b>
				FAN	MTR-CODE: OM541.940; OE-NO.: 5419972592; MOD: 1832;1832LS;SA50516109	<b>12 PK 1515 TM</b>
				FAN	MTR-CODE: OM541.940; OE-NO.: 5419973092; MOD: 1832;1832LS;SA50516115	<b>12 PK 1507 TM</b>
				HYD-P	MTR-CODE: OM541.940; OE-NO.: 0009938196; MOD: 1832;1832LS;SA50516118/19	<b>8 PK 1202 TM</b>
				HYD-P	MTR-CODE: OM541.940; OE-NO.: 5419972892; MOD: 1832;1832LS;SA50516110/11	<b>8 PK 1215 TM</b>
				HYD-P	MTR-CODE: OM541.940; OE-NO.: 5419972892; MOD: 1832;1832LS;SA50516901	<b>8 PK 1215 TM</b>
				HYD-P	MTR-CODE: OM541.940; OE-NO.: 5419972892; MOD: 1832;1832LS;SA59902001/02	<b>8 PK 1215 TM</b>
				W-P	MTR-CODE: OM541.940; OE-NO.: 0009937896; MOD: 1832;1832LS;SA50516117	<b>9 PK 2871 TM</b>
				W-P	MTR-CODE: OM541.940; OE-NO.: 5419970992; MOD: 1832;1832LS;SA50516102	<b>9 PK 2835 TM</b>
				W-P	MTR-CODE: OM541.940; OE-NO.: 5419971092; MOD: 1832;1832LS;SA50516103	<b>9 PK 2295 TM</b>
				ALT; AC-C	MTR-CODE: OM 541.920	<b>KT 7004</b>
	OM 541.940;OM 541.971;OM 541.997			ALT	MTR-CODE: OM541.940; OE-NO.: 0009938096; MOD: 1832;1832LS;SA50516119	<b>11 PK 2871 TM</b>
				ALT	MTR-CODE: OM541.940; OE-NO.: 5419972692; MOD: 1832;1832LS;SA50516110	<b>11 PK 1890 TM</b>



## MERCEDES-BENZ

### ACTROS MP2 / MP3

#### 1832

11946 ccm	235 kW	OM 541.940;OM 541.971;OM 541.997	04.03 -	ALT	MTR-CODE: OM541.940; OE-NO.: 5419972692; MOD: 1832;1832LS;SA50516901	11 PK 1890 TM
				ALT	MTR-CODE: OM541.940; OE-NO.: 5419972692; MOD: 1832;1832LS;SA59902001/02	11 PK 1890 TM
				ALT	MTR-CODE: OM541.940; OE-NO.: 5419972792; MOD: 1832;1832LS;SA50516111	11 PK 2835 TM
				ALT	MTR-CODE: OM541.940; OE-NO.: 5419972792; MOD: 1832;1832LS;SA59902001/02	11 PK 2835 TM
				FAN	MTR-CODE: OM541.940; OE-NO.: 0009937796; MOD: 1832;1832LS;SA50516116	9 PK 1920 TM
				FAN	MTR-CODE: OM541.940; OE-NO.: 5419970892; MOD: 1832;1832LS;SA50516101	9 PK 1888 TM
				FAN	MTR-CODE: OM541.940; OE-NO.: 5419972592; MOD: 1832;1832LS;SA50516109	12 PK 1515 TM
				FAN	MTR-CODE: OM541.940; OE-NO.: 5419973092; MOD: 1832;1832LS;SA50516115	12 PK 1507 TM
				HYD-P	MTR-CODE: OM541.940; OE-NO.: 0009938196; MOD: 1832;1832LS;SA50516118/19	8 PK 1202 TM
				HYD-P	MTR-CODE: OM541.940; OE-NO.: 5419972892; MOD: 1832;1832LS;SA50516110/11	8 PK 1215 TM
				HYD-P	MTR-CODE: OM541.940; OE-NO.: 5419972892; MOD: 1832;1832LS;SA50516901	8 PK 1215 TM
				HYD-P	MTR-CODE: OM541.940; OE-NO.: 5419972892; MOD: 1832;1832LS;SA59902001/02	8 PK 1215 TM
				W-P	MTR-CODE: OM541.940; OE-NO.: 0009937896; MOD: 1832;1832LS;SA50516117	9 PK 2871 TM
				W-P	MTR-CODE: OM541.940; OE-NO.: 5419970992; MOD: 1832;1832LS;SA50516102	9 PK 2835 TM
				W-P	MTR-CODE: OM541.940; OE-NO.: 5419971092; MOD: 1832;1832LS;SA50516103	9 PK 2295 TM
				ALT; AC-C	MTR-CODE: OM 541.920	KT 7004

#### 1836

11946 ccm	265 kW	OM 541.942	10.02 -	ALT	MTR-CODE: OM541.940; OE-NO.: 0009938096; MOD: 1832;1832LS;SA50516119	11 PK 2871 TM
				ALT	MTR-CODE: OM541.940; OE-NO.: 5419972692; MOD: 1832;1832LS;SA50516110	11 PK 1890 TM
				ALT	MTR-CODE: OM541.940; OE-NO.: 5419972692; MOD: 1832;1832LS;SA50516901	11 PK 1890 TM
				ALT	MTR-CODE: OM541.940; OE-NO.: 5419972692; MOD: 1832;1832LS;SA59902001/02	11 PK 1890 TM
				ALT	MTR-CODE: OM541.940; OE-NO.: 5419972792; MOD: 1832;1832LS;SA50516111	11 PK 2835 TM
				ALT	MTR-CODE: OM541.940; OE-NO.: 5419972792; MOD: 1832;1832LS;SA59902001/02	11 PK 2835 TM
				FAN	MTR-CODE: OM541.940; OE-NO.: 0009937796; MOD: 1832;1832LS;SA50516116	9 PK 1920 TM
				FAN	MTR-CODE: OM541.940; OE-NO.: 5419970892; MOD: 1832;1832LS;SA50516101	9 PK 1888 TM
				FAN	MTR-CODE: OM541.940; OE-NO.: 5419972592; MOD: 1832;1832LS;SA50516109	12 PK 1515 TM
				FAN	MTR-CODE: OM541.940; OE-NO.: 5419973092; MOD: 1832;1832LS;SA50516115	12 PK 1507 TM
				HYD-P	MTR-CODE: OM541.940; OE-NO.: 0009938196; MOD: 1832;1832LS;SA50516118/19	8 PK 1202 TM
				HYD-P	MTR-CODE: OM541.940; OE-NO.: 5419972892; MOD: 1832;1832LS;SA50516110/11	8 PK 1215 TM
				HYD-P	MTR-CODE: OM541.940; OE-NO.: 5419972892; MOD: 1832;1832LS;SA50516901	8 PK 1215 TM
				HYD-P	MTR-CODE: OM541.940; OE-NO.: 5419972892; MOD: 1832;1832LS;SA59902001/02	8 PK 1215 TM
				W-P	MTR-CODE: OM541.940; OE-NO.: 0009937896; MOD: 1832;1832LS;SA50516117	9 PK 2871 TM
				W-P	MTR-CODE: OM541.940; OE-NO.: 5419970992; MOD: 1832;1832LS;SA50516102	9 PK 2835 TM
				W-P	MTR-CODE: OM541.940; OE-NO.: 5419971092; MOD: 1832;1832LS;SA50516103	9 PK 2295 TM
				ALT; AC-C	MTR-CODE: OM 541.920	KT 7004
		OM 541.942;OM 541.972;OM 541.998		ALT	MTR-CODE: OM541.940; OE-NO.: 0009938096; MOD: 1832;1832LS;SA50516119	11 PK 2871 TM
				ALT	MTR-CODE: OM541.940; OE-NO.: 5419972692; MOD: 1832;1832LS;SA50516110	11 PK 1890 TM
				ALT	MTR-CODE: OM541.940; OE-NO.: 5419972692; MOD: 1832;1832LS;SA50516901	11 PK 1890 TM



## MERCEDES-BENZ

### ACTROS MP2 / MP3

#### 1836

11946 ccm	265 kW	OM 541.942;OM 541.972;OM 541.998	10.02 -	ALT	MTR-CODE: OM541.940; OE-NO.: 5419972692; MOD: 1832;1832LS;SA59902001/02	<b>11 PK 1890 TM</b>
				ALT	MTR-CODE: OM541.940; OE-NO.: 5419972792; MOD: 1832;1832LS;SA50516111	<b>11 PK 2835 TM</b>
				ALT	MTR-CODE: OM541.940; OE-NO.: 5419972792; MOD: 1832;1832LS;SA59902001/02	<b>11 PK 2835 TM</b>
				FAN	MTR-CODE: OM541.940; OE-NO.: 0009937796; MOD: 1832;1832LS;SA50516116	<b>9 PK 1920 TM</b>
				FAN	MTR-CODE: OM541.940; OE-NO.: 5419970892; MOD: 1832;1832LS;SA50516101	<b>9 PK 1888 TM</b>
				FAN	MTR-CODE: OM541.940; OE-NO.: 5419972592; MOD: 1832;1832LS;SA50516109	<b>12 PK 1515 TM</b>
				FAN	MTR-CODE: OM541.940; OE-NO.: 5419973092; MOD: 1832;1832LS;SA50516115	<b>12 PK 1507 TM</b>
				HYD-P	MTR-CODE: OM541.940; OE-NO.: 0009938196; MOD: 1832;1832LS;SA50516118/19	<b>8 PK 1202 TM</b>
				HYD-P	MTR-CODE: OM541.940; OE-NO.: 5419972892; MOD: 1832;1832LS;SA50516110/11	<b>8 PK 1215 TM</b>
				HYD-P	MTR-CODE: OM541.940; OE-NO.: 5419972892; MOD: 1832;1832LS;SA50516901	<b>8 PK 1215 TM</b>
				HYD-P	MTR-CODE: OM541.940; OE-NO.: 5419972892; MOD: 1832;1832LS;SA59902001/02	<b>8 PK 1215 TM</b>
				W-P	MTR-CODE: OM541.940; OE-NO.: 0009937896; MOD: 1832;1832LS;SA50516117	<b>9 PK 2871 TM</b>
				W-P	MTR-CODE: OM541.940; OE-NO.: 5419970992; MOD: 1832;1832LS;SA50516102	<b>9 PK 2835 TM</b>
				W-P	MTR-CODE: OM541.940; OE-NO.: 5419971092; MOD: 1832;1832LS;SA50516103	<b>9 PK 2295 TM</b>
				ALT; AC-C	MTR-CODE: OM 541.920	<b>KT 7004</b>
		OM 541.942;OM 541.999		ALT	MTR-CODE: OM541.940; OE-NO.: 0009938096; MOD: 1832;1832LS;SA50516119	<b>11 PK 2871 TM</b>
				ALT	MTR-CODE: OM541.940; OE-NO.: 5419972692; MOD: 1832;1832LS;SA50516110	<b>11 PK 1890 TM</b>
				ALT	MTR-CODE: OM541.940; OE-NO.: 5419972692; MOD: 1832;1832LS;SA50516901	<b>11 PK 1890 TM</b>
				ALT	MTR-CODE: OM541.940; OE-NO.: 5419972692; MOD: 1832;1832LS;SA59902001/02	<b>11 PK 1890 TM</b>
				ALT	MTR-CODE: OM541.940; OE-NO.: 5419972792; MOD: 1832;1832LS;SA50516111	<b>11 PK 2835 TM</b>
				ALT	MTR-CODE: OM541.940; OE-NO.: 5419972792; MOD: 1832;1832LS;SA59902001/02	<b>11 PK 2835 TM</b>
				FAN	MTR-CODE: OM541.940; OE-NO.: 0009937796; MOD: 1832;1832LS;SA50516116	<b>9 PK 1920 TM</b>
				FAN	MTR-CODE: OM541.940; OE-NO.: 5419970892; MOD: 1832;1832LS;SA50516101	<b>9 PK 1888 TM</b>
				FAN	MTR-CODE: OM541.940; OE-NO.: 5419972592; MOD: 1832;1832LS;SA50516109	<b>12 PK 1515 TM</b>
				FAN	MTR-CODE: OM541.940; OE-NO.: 5419973092; MOD: 1832;1832LS;SA50516115	<b>12 PK 1507 TM</b>
				HYD-P	MTR-CODE: OM541.940; OE-NO.: 0009938196; MOD: 1832;1832LS;SA50516118/19	<b>8 PK 1202 TM</b>
				HYD-P	MTR-CODE: OM541.940; OE-NO.: 5419972892; MOD: 1832;1832LS;SA50516110/11	<b>8 PK 1215 TM</b>
				HYD-P	MTR-CODE: OM541.940; OE-NO.: 5419972892; MOD: 1832;1832LS;SA50516901	<b>8 PK 1215 TM</b>
				HYD-P	MTR-CODE: OM541.940; OE-NO.: 5419972892; MOD: 1832;1832LS;SA59902001/02	<b>8 PK 1215 TM</b>
				W-P	MTR-CODE: OM541.940; OE-NO.: 0009937896; MOD: 1832;1832LS;SA50516117	<b>9 PK 2871 TM</b>
				W-P	MTR-CODE: OM541.940; OE-NO.: 5419970992; MOD: 1832;1832LS;SA50516102	<b>9 PK 2835 TM</b>
				W-P	MTR-CODE: OM541.940; OE-NO.: 5419971092; MOD: 1832;1832LS;SA50516103	<b>9 PK 2295 TM</b>
				ALT; AC-C	MTR-CODE: OM 541.920	<b>KT 7004</b>

#### 1841

11946 ccm	300 kW	OM 541.944;OM 541.974	10.02 -	ALT	MTR-CODE: OM541.940; OE-NO.: 0009938096; MOD: 1832;1832LS;SA50516119	<b>11 PK 2871 TM</b>
				ALT	MTR-CODE: OM541.940; OE-NO.: 5419972692; MOD: 1832;1832LS;SA50516110	<b>11 PK 1890 TM</b>
				ALT	MTR-CODE: OM541.940; OE-NO.: 5419972692; MOD: 1832;1832LS;SA50516901	<b>11 PK 1890 TM</b>
				ALT	MTR-CODE: OM541.940; OE-NO.: 5419972692; MOD: 1832;1832LS;SA59902001/02	<b>11 PK 1890 TM</b>

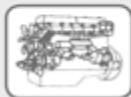

## MERCEDES-BENZ

### ACTROS MP2 / MP3

#### 1841

11946 ccm	300 kW	OM 541.944;OM 541.974	10.02 -	ALT	MTR-CODE: OM541.940; OE-NO.: 5419972792; MOD: 1832;1832LS;SA50516111	<b>11 PK 2835 TM</b>
				ALT	MTR-CODE: OM541.940; OE-NO.: 5419972792; MOD: 1832;1832LS;SA59902001/02	<b>11 PK 2835 TM</b>
				FAN	MTR-CODE: OM541.940; OE-NO.: 0009937796; MOD: 1832;1832LS;SA50516116	<b>9 PK 1920 TM</b>
				FAN	MTR-CODE: OM541.940; OE-NO.: 5419970892; MOD: 1832;1832LS;SA50516101	<b>9 PK 1888 TM</b>
				FAN	MTR-CODE: OM541.940; OE-NO.: 5419972592; MOD: 1832;1832LS;SA50516109	<b>12 PK 1515 TM</b>
				FAN	MTR-CODE: OM541.940; OE-NO.: 5419973092; MOD: 1832;1832LS;SA50516115	<b>12 PK 1507 TM</b>
				HYD-P	MTR-CODE: OM541.940; OE-NO.: 0009938196; MOD: 1832;1832LS;SA50516118/19	<b>8 PK 1202 TM</b>
				HYD-P	MTR-CODE: OM541.940; OE-NO.: 5419972892; MOD: 1832;1832LS;SA50516110/11	<b>8 PK 1215 TM</b>
				HYD-P	MTR-CODE: OM541.940; OE-NO.: 5419972892; MOD: 1832;1832LS;SA50516901	<b>8 PK 1215 TM</b>
				HYD-P	MTR-CODE: OM541.940; OE-NO.: 5419972892; MOD: 1832;1832LS;SA59902001/02	<b>8 PK 1215 TM</b>
				W-P	MTR-CODE: OM541.940; OE-NO.: 0009937896; MOD: 1832;1832LS;SA50516117	<b>9 PK 2871 TM</b>
				W-P	MTR-CODE: OM541.940; OE-NO.: 5419970992; MOD: 1832;1832LS;SA50516102	<b>9 PK 2835 TM</b>
				W-P	MTR-CODE: OM541.940; OE-NO.: 5419971092; MOD: 1832;1832LS;SA50516103	<b>9 PK 2295 TM</b>
				ALT; AC-C	MTR-CODE: OM 541.920	<b>KT 7004</b>
		OM 541.944;OM 541.974;OM 541.990		ALT	MTR-CODE: OM541.940; OE-NO.: 0009938096; MOD: 1832;1832LS;SA50516119	<b>11 PK 2871 TM</b>
				ALT	MTR-CODE: OM541.940; OE-NO.: 5419972692; MOD: 1832;1832LS;SA50516110	<b>11 PK 1890 TM</b>
				ALT	MTR-CODE: OM541.940; OE-NO.: 5419972692; MOD: 1832;1832LS;SA50516901	<b>11 PK 1890 TM</b>
				ALT	MTR-CODE: OM541.940; OE-NO.: 5419972692; MOD: 1832;1832LS;SA59902001/02	<b>11 PK 1890 TM</b>
				ALT	MTR-CODE: OM541.940; OE-NO.: 5419972792; MOD: 1832;1832LS;SA50516111	<b>11 PK 2835 TM</b>
				ALT	MTR-CODE: OM541.940; OE-NO.: 5419972792; MOD: 1832;1832LS;SA59902001/02	<b>11 PK 2835 TM</b>
				FAN	MTR-CODE: OM541.940; OE-NO.: 0009937796; MOD: 1832;1832LS;SA50516116	<b>9 PK 1920 TM</b>
				FAN	MTR-CODE: OM541.940; OE-NO.: 5419970892; MOD: 1832;1832LS;SA50516101	<b>9 PK 1888 TM</b>
				FAN	MTR-CODE: OM541.940; OE-NO.: 5419972592; MOD: 1832;1832LS;SA50516109	<b>12 PK 1515 TM</b>
				FAN	MTR-CODE: OM541.940; OE-NO.: 5419973092; MOD: 1832;1832LS;SA50516115	<b>12 PK 1507 TM</b>
				HYD-P	MTR-CODE: OM541.940; OE-NO.: 0009938196; MOD: 1832;1832LS;SA50516118/19	<b>8 PK 1202 TM</b>
				HYD-P	MTR-CODE: OM541.940; OE-NO.: 5419972892; MOD: 1832;1832LS;SA50516110/11	<b>8 PK 1215 TM</b>
				HYD-P	MTR-CODE: OM541.940; OE-NO.: 5419972892; MOD: 1832;1832LS;SA50516901	<b>8 PK 1215 TM</b>
				HYD-P	MTR-CODE: OM541.940; OE-NO.: 5419972892; MOD: 1832;1832LS;SA59902001/02	<b>8 PK 1215 TM</b>
				W-P	MTR-CODE: OM541.940; OE-NO.: 0009937896; MOD: 1832;1832LS;SA50516117	<b>9 PK 2871 TM</b>
				W-P	MTR-CODE: OM541.940; OE-NO.: 5419970992; MOD: 1832;1832LS;SA50516102	<b>9 PK 2835 TM</b>
				W-P	MTR-CODE: OM541.940; OE-NO.: 5419971092; MOD: 1832;1832LS;SA50516103	<b>9 PK 2295 TM</b>
				ALT; AC-C	MTR-CODE: OM 541.920	<b>KT 7004</b>

#### 1844

11946 ccm	315-320 kW	OM 541.921;OM 541.946;OM 541.947;OM 541.993	04.03 -	ALT	MTR-CODE: OM541.940; OE-NO.: 0009938096; MOD: 1832;1832LS;SA50516119	<b>11 PK 2871 TM</b>
				ALT	MTR-CODE: OM541.940; OE-NO.: 5419972692; MOD: 1832;1832LS;SA50516110	<b>11 PK 1890 TM</b>
				ALT	MTR-CODE: OM541.940; OE-NO.: 5419972692; MOD: 1832;1832LS;SA50516901	<b>11 PK 1890 TM</b>
				ALT	MTR-CODE: OM541.940; OE-NO.: 5419972692; MOD: 1832;1832LS;SA59902001/02	<b>11 PK 1890 TM</b>
				ALT	MTR-CODE: OM541.940; OE-NO.: 5419972792; MOD: 1832;1832LS;SA50516111	<b>11 PK 2835 TM</b>



## MERCEDES-BENZ

### ACTROS MP2 / MP3

**1844**

11946 ccm	315-320 kW	OM 541.921;OM 541.946;OM 541.947;OM 541.993	04.03 -	ALT	MTR-CODE: OM541.940; OE-NO.: 5419972792; MOD: 1832;1832LS;SA59902001/02	<b>11 PK 2835 TM</b>
				FAN	MTR-CODE: OM541.940; OE-NO.: 0009937796; MOD: 1832;1832LS;SA50516116	<b>9 PK 1920 TM</b>
				FAN	MTR-CODE: OM541.940; OE-NO.: 5419970892; MOD: 1832;1832LS;SA50516101	<b>9 PK 1888 TM</b>
				FAN	MTR-CODE: OM541.940; OE-NO.: 5419972592; MOD: 1832;1832LS;SA50516109	<b>12 PK 1515 TM</b>
				FAN	MTR-CODE: OM541.940; OE-NO.: 5419973092; MOD: 1832;1832LS;SA50516115	<b>12 PK 1507 TM</b>
				HYD-P	MTR-CODE: OM541.940; OE-NO.: 0009938196; MOD: 1832;1832LS;SA50516118/19	<b>8 PK 1202 TM</b>
				HYD-P	MTR-CODE: OM541.940; OE-NO.: 5419972892; MOD: 1832;1832LS;SA50516110/11	<b>8 PK 1215 TM</b>
				HYD-P	MTR-CODE: OM541.940; OE-NO.: 5419972892; MOD: 1832;1832LS;SA50516901	<b>8 PK 1215 TM</b>
				HYD-P	MTR-CODE: OM541.940; OE-NO.: 5419972892; MOD: 1832;1832LS;SA59902001/02	<b>8 PK 1215 TM</b>
				W-P	MTR-CODE: OM541.940; OE-NO.: 0009937896; MOD: 1832;1832LS;SA50516117	<b>9 PK 2871 TM</b>
				W-P	MTR-CODE: OM541.940; OE-NO.: 5419970992; MOD: 1832;1832LS;SA50516102	<b>9 PK 2835 TM</b>
				W-P	MTR-CODE: OM541.940; OE-NO.: 5419971092; MOD: 1832;1832LS;SA50516103	<b>9 PK 2295 TM</b>
				ALT; AC-C	MTR-CODE: 541.920	<b>KT 7004</b>
		OM 541.925;OM 541.946;OM 541.976;OM 541.992		ALT	MTR-CODE: OM541.940; OE-NO.: 0009938096; MOD: 1832;1832LS;SA50516119	<b>11 PK 2871 TM</b>
				ALT	MTR-CODE: OM541.940; OE-NO.: 5419972692; MOD: 1832;1832LS;SA50516110	<b>11 PK 1890 TM</b>
				ALT	MTR-CODE: OM541.940; OE-NO.: 5419972692; MOD: 1832;1832LS;SA50516901	<b>11 PK 1890 TM</b>
				ALT	MTR-CODE: OM541.940; OE-NO.: 5419972692; MOD: 1832;1832LS;SA59902001/02	<b>11 PK 1890 TM</b>
				ALT	MTR-CODE: OM541.940; OE-NO.: 5419972792; MOD: 1832;1832LS;SA50516111	<b>11 PK 2835 TM</b>
				ALT	MTR-CODE: OM541.940; OE-NO.: 5419972792; MOD: 1832;1832LS;SA59902001/02	<b>11 PK 2835 TM</b>
				FAN	MTR-CODE: OM541.940; OE-NO.: 0009937796; MOD: 1832;1832LS;SA50516116	<b>9 PK 1920 TM</b>
				FAN	MTR-CODE: OM541.940; OE-NO.: 5419970892; MOD: 1832;1832LS;SA50516101	<b>9 PK 1888 TM</b>
				FAN	MTR-CODE: OM541.940; OE-NO.: 5419972592; MOD: 1832;1832LS;SA50516109	<b>12 PK 1515 TM</b>
				FAN	MTR-CODE: OM541.940; OE-NO.: 5419973092; MOD: 1832;1832LS;SA50516115	<b>12 PK 1507 TM</b>
				HYD-P	MTR-CODE: OM541.940; OE-NO.: 0009938196; MOD: 1832;1832LS;SA50516118/19	<b>8 PK 1202 TM</b>
				HYD-P	MTR-CODE: OM541.940; OE-NO.: 5419972892; MOD: 1832;1832LS;SA50516110/11	<b>8 PK 1215 TM</b>
				HYD-P	MTR-CODE: OM541.940; OE-NO.: 5419972892; MOD: 1832;1832LS;SA50516901	<b>8 PK 1215 TM</b>
				HYD-P	MTR-CODE: OM541.940; OE-NO.: 5419972892; MOD: 1832;1832LS;SA59902001/02	<b>8 PK 1215 TM</b>
				W-P	MTR-CODE: OM541.940; OE-NO.: 0009937896; MOD: 1832;1832LS;SA50516117	<b>9 PK 2871 TM</b>
				W-P	MTR-CODE: OM541.940; OE-NO.: 5419970992; MOD: 1832;1832LS;SA50516102	<b>9 PK 2835 TM</b>
				W-P	MTR-CODE: OM541.940; OE-NO.: 5419971092; MOD: 1832;1832LS;SA50516103	<b>9 PK 2295 TM</b>
				ALT; AC-C	MTR-CODE: OM 541.920	<b>KT 7004</b>
320 kW		OM 541.946;OM 541.976		ALT	MTR-CODE: OM541.940; OE-NO.: 0009938096; MOD: 1832;1832LS;SA50516119	<b>11 PK 2871 TM</b>
				ALT	MTR-CODE: OM541.940; OE-NO.: 5419972692; MOD: 1832;1832LS;SA50516110	<b>11 PK 1890 TM</b>
				ALT	MTR-CODE: OM541.940; OE-NO.: 5419972692; MOD: 1832;1832LS;SA50516901	<b>11 PK 1890 TM</b>
				ALT	MTR-CODE: OM541.940; OE-NO.: 5419972692; MOD: 1832;1832LS;SA59902001/02	<b>11 PK 1890 TM</b>
				ALT	MTR-CODE: OM541.940; OE-NO.: 5419972792; MOD: 1832;1832LS;SA50516111	<b>11 PK 2835 TM</b>
				ALT	MTR-CODE: OM541.940; OE-NO.: 5419972792; MOD: 1832;1832LS;SA59902001/02	<b>11 PK 2835 TM</b>
				FAN	MTR-CODE: OM541.940; OE-NO.: 0009937796; MOD: 1832;1832LS;SA50516116	<b>9 PK 1920 TM</b>



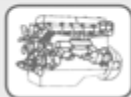

## MERCEDES-BENZ

### ACTROS MP2 / MP3

#### 1844

11946 ccm	320 kW	OM 541.946;OM 541.976	04.03 -	FAN	MTR-CODE: OM541.940; OE-NO.: 5419970892; MOD: 1832;1832LS;SA50516101	<b>9 PK 1888 TM</b>
				FAN	MTR-CODE: OM541.940; OE-NO.: 5419972592; MOD: 1832;1832LS;SA50516109	<b>12 PK 1515 TM</b>
				FAN	MTR-CODE: OM541.940; OE-NO.: 5419973092; MOD: 1832;1832LS;SA50516115	<b>12 PK 1507 TM</b>
				HYD-P	MTR-CODE: OM541.940; OE-NO.: 0009938196; MOD: 1832;1832LS;SA50516118/19	<b>8 PK 1202 TM</b>
				HYD-P	MTR-CODE: OM541.940; OE-NO.: 5419972892; MOD: 1832;1832LS;SA50516110/11	<b>8 PK 1215 TM</b>
				HYD-P	MTR-CODE: OM541.940; OE-NO.: 5419972892; MOD: 1832;1832LS;SA50516901	<b>8 PK 1215 TM</b>
				HYD-P	MTR-CODE: OM541.940; OE-NO.: 5419972892; MOD: 1832;1832LS;SA59902001/02	<b>8 PK 1215 TM</b>
				W-P	MTR-CODE: OM541.940; OE-NO.: 0009937896; MOD: 1832;1832LS;SA50516117	<b>9 PK 2871 TM</b>
				W-P	MTR-CODE: OM541.940; OE-NO.: 5419970992; MOD: 1832;1832LS;SA50516102	<b>9 PK 2835 TM</b>
				W-P	MTR-CODE: OM541.940; OE-NO.: 5419971092; MOD: 1832;1832LS;SA50516103	<b>9 PK 2295 TM</b>
				ALT; AC-C	MTR-CODE: OM 541.920	<b>KT 7004</b>

#### 1846

11946 ccm	335 kW	OM 541.948;OM 541.949;OM 541.981;OM 541.995	04.03 -	ALT	MTR-CODE: OM541.940; OE-NO.: 0009938096; MOD: 1832;1832LS;SA50516119	<b>11 PK 2871 TM</b>
				ALT	MTR-CODE: OM541.940; OE-NO.: 5419972692; MOD: 1832;1832LS;SA50516110	<b>11 PK 1890 TM</b>
				ALT	MTR-CODE: OM541.940; OE-NO.: 5419972692; MOD: 1832;1832LS;SA50516901	<b>11 PK 1890 TM</b>
				ALT	MTR-CODE: OM541.940; OE-NO.: 5419972692; MOD: 1832;1832LS;SA59902001/02	<b>11 PK 1890 TM</b>
				ALT	MTR-CODE: OM541.940; OE-NO.: 5419972792; MOD: 1832;1832LS;SA50516111	<b>11 PK 2835 TM</b>
				ALT	MTR-CODE: OM541.940; OE-NO.: 5419972792; MOD: 1832;1832LS;SA59902001/02	<b>11 PK 2835 TM</b>
				FAN	MTR-CODE: OM541.940; OE-NO.: 0009937796; MOD: 1832;1832LS;SA50516116	<b>9 PK 1920 TM</b>
				FAN	MTR-CODE: OM541.940; OE-NO.: 5419970892; MOD: 1832;1832LS;SA50516101	<b>9 PK 1888 TM</b>
				FAN	MTR-CODE: OM541.940; OE-NO.: 5419972592; MOD: 1832;1832LS;SA50516109	<b>12 PK 1515 TM</b>
				FAN	MTR-CODE: OM541.940; OE-NO.: 5419973092; MOD: 1832;1832LS;SA50516115	<b>12 PK 1507 TM</b>
				HYD-P	MTR-CODE: OM541.940; OE-NO.: 0009938196; MOD: 1832;1832LS;SA50516118/19	<b>8 PK 1202 TM</b>
				HYD-P	MTR-CODE: OM541.940; OE-NO.: 5419972892; MOD: 1832;1832LS;SA50516110/11	<b>8 PK 1215 TM</b>
				HYD-P	MTR-CODE: OM541.940; OE-NO.: 5419972892; MOD: 1832;1832LS;SA50516901	<b>8 PK 1215 TM</b>
				HYD-P	MTR-CODE: OM541.940; OE-NO.: 5419972892; MOD: 1832;1832LS;SA59902001/02	<b>8 PK 1215 TM</b>
				W-P	MTR-CODE: OM541.940; OE-NO.: 0009937896; MOD: 1832;1832LS;SA50516117	<b>9 PK 2871 TM</b>
				W-P	MTR-CODE: OM541.940; OE-NO.: 5419970992; MOD: 1832;1832LS;SA50516102	<b>9 PK 2835 TM</b>
				W-P	MTR-CODE: OM541.940; OE-NO.: 5419971092; MOD: 1832;1832LS;SA50516103	<b>9 PK 2295 TM</b>
				ALT; AC-C	MTR-CODE: OM 541.920	<b>KT 7004</b>
		OM 541.948;OM 541.980		ALT	MTR-CODE: OM541.940; OE-NO.: 0009938096; MOD: 1832;1832LS;SA50516119	<b>11 PK 2871 TM</b>
				ALT	MTR-CODE: OM541.940; OE-NO.: 5419972692; MOD: 1832;1832LS;SA50516110	<b>11 PK 1890 TM</b>
				ALT	MTR-CODE: OM541.940; OE-NO.: 5419972692; MOD: 1832;1832LS;SA50516901	<b>11 PK 1890 TM</b>
				ALT	MTR-CODE: OM541.940; OE-NO.: 5419972692; MOD: 1832;1832LS;SA59902001/02	<b>11 PK 1890 TM</b>
				ALT	MTR-CODE: OM541.940; OE-NO.: 5419972792; MOD: 1832;1832LS;SA50516111	<b>11 PK 2835 TM</b>
				ALT	MTR-CODE: OM541.940; OE-NO.: 5419972792; MOD: 1832;1832LS;SA59902001/02	<b>11 PK 2835 TM</b>
				FAN	MTR-CODE: OM541.940; OE-NO.: 0009937796; MOD: 1832;1832LS;SA50516116	<b>9 PK 1920 TM</b>
				FAN	MTR-CODE: OM541.940; OE-NO.: 5419970892; MOD: 1832;1832LS;SA50516101	<b>9 PK 1888 TM</b>

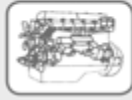

## MERCEDES-BENZ

### ACTROS MP2 / MP3

#### 1846

11946 ccm	335 kW	OM 541.948;OM 541.980	04.03 -	FAN	MTR-CODE: OM541.940; OE-NO.: 5419972592; MOD: 1832;1832LS;SA50516109	<b>12 PK 1515 TM</b>
				FAN	MTR-CODE: OM541.940; OE-NO.: 5419973092; MOD: 1832;1832LS;SA50516115	<b>12 PK 1507 TM</b>
				HYD-P	MTR-CODE: OM541.940; OE-NO.: 0009938196; MOD: 1832;1832LS;SA50516118/19	<b>8 PK 1202 TM</b>
				HYD-P	MTR-CODE: OM541.940; OE-NO.: 5419972892; MOD: 1832;1832LS;SA50516110/11	<b>8 PK 1215 TM</b>
				HYD-P	MTR-CODE: OM541.940; OE-NO.: 5419972892; MOD: 1832;1832LS;SA50516901	<b>8 PK 1215 TM</b>
				HYD-P	MTR-CODE: OM541.940; OE-NO.: 5419972892; MOD: 1832;1832LS;SA59902001/02	<b>8 PK 1215 TM</b>
				W-P	MTR-CODE: OM541.940; OE-NO.: 0009937896; MOD: 1832;1832LS;SA50516117	<b>9 PK 2871 TM</b>
				W-P	MTR-CODE: OM541.940; OE-NO.: 5419970992; MOD: 1832;1832LS;SA50516102	<b>9 PK 2835 TM</b>
				W-P	MTR-CODE: OM541.940; OE-NO.: 5419971092; MOD: 1832;1832LS;SA50516103	<b>9 PK 2295 TM</b>
				ALT; AC-C	MTR-CODE: OM 541.920	<b>KT 7004</b>
	OM 541.948;OM 541.980;OM 541.994			ALT	MTR-CODE: OM541.940; OE-NO.: 0009938096; MOD: 1832;1832LS;SA50516119	<b>11 PK 2871 TM</b>
				ALT	MTR-CODE: OM541.940; OE-NO.: 5419972692; MOD: 1832;1832LS;SA50516110	<b>11 PK 1890 TM</b>
				ALT	MTR-CODE: OM541.940; OE-NO.: 5419972692; MOD: 1832;1832LS;SA50516901	<b>11 PK 1890 TM</b>
				ALT	MTR-CODE: OM541.940; OE-NO.: 5419972692; MOD: 1832;1832LS;SA59902001/02	<b>11 PK 1890 TM</b>
				ALT	MTR-CODE: OM541.940; OE-NO.: 5419972792; MOD: 1832;1832LS;SA50516111	<b>11 PK 2835 TM</b>
				ALT	MTR-CODE: OM541.940; OE-NO.: 5419972792; MOD: 1832;1832LS;SA59902001/02	<b>11 PK 2835 TM</b>
				FAN	MTR-CODE: OM541.940; OE-NO.: 0009937796; MOD: 1832;1832LS;SA50516116	<b>9 PK 1920 TM</b>
				FAN	MTR-CODE: OM541.940; OE-NO.: 5419970892; MOD: 1832;1832LS;SA50516101	<b>9 PK 1888 TM</b>
				FAN	MTR-CODE: OM541.940; OE-NO.: 5419972592; MOD: 1832;1832LS;SA50516109	<b>12 PK 1515 TM</b>
				FAN	MTR-CODE: OM541.940; OE-NO.: 5419973092; MOD: 1832;1832LS;SA50516115	<b>12 PK 1507 TM</b>
				HYD-P	MTR-CODE: OM541.940; OE-NO.: 0009938196; MOD: 1832;1832LS;SA50516118/19	<b>8 PK 1202 TM</b>
				HYD-P	MTR-CODE: OM541.940; OE-NO.: 5419972892; MOD: 1832;1832LS;SA50516110/11	<b>8 PK 1215 TM</b>
				HYD-P	MTR-CODE: OM541.940; OE-NO.: 5419972892; MOD: 1832;1832LS;SA50516901	<b>8 PK 1215 TM</b>
				HYD-P	MTR-CODE: OM541.940; OE-NO.: 5419972892; MOD: 1832;1832LS;SA59902001/02	<b>8 PK 1215 TM</b>
				W-P	MTR-CODE: OM541.940; OE-NO.: 0009937896; MOD: 1832;1832LS;SA50516117	<b>9 PK 2871 TM</b>
				W-P	MTR-CODE: OM541.940; OE-NO.: 5419970992; MOD: 1832;1832LS;SA50516102	<b>9 PK 2835 TM</b>
				W-P	MTR-CODE: OM541.940; OE-NO.: 5419971092; MOD: 1832;1832LS;SA50516103	<b>9 PK 2295 TM</b>
				ALT; AC-C	MTR-CODE: OM 541.920	<b>KT 7004</b>

#### 1850; 1851

15928 ccm	370-375 kW	OM 542.940;OM 542.941;OM 542.960;OM 542.961	04.03 -	ALT	MTR-CODE: OM542.940; OE-NO.: 5419972692; MOD: 1846,L,LL;1850K;SA50516110	<b>11 PK 1890 TM</b>
				ALT	MTR-CODE: OM542.940; OE-NO.: 5419972692; MOD: 1846,L,LL;1850K;SA50516901	<b>11 PK 1890 TM</b>
				ALT	MTR-CODE: OM542.940; OE-NO.: 5419972692; MOD: 1846,L,LL;1850K;SA59902001/02	<b>11 PK 1890 TM</b>
				ALT	MTR-CODE: OM542.940; OE-NO.: 5419972792; MOD: 1846,L,LL;1850K;SA50516111	<b>11 PK 2835 TM</b>
				ALT	MTR-CODE: OM542.940; OE-NO.: 5419972792; MOD: 1846,L,LL;1850K;SA59902001/02	<b>11 PK 2835 TM</b>
				FAN	MTR-CODE: OM542.940; OE-NO.: 5419970892; MOD: 1846,L,LL;1850K;SA50516101	<b>9 PK 1888 TM</b>
				HYD-P	MTR-CODE: OM542.940; OE-NO.: 0009938196; MOD: 1846,L,LL;1850K;SA50516118/19	<b>8 PK 1202 TM</b>
				HYD-P	MTR-CODE: OM542.940; OE-NO.: 5419972892; MOD: 1846,L,LL;1850K;SA50516110/11	<b>8 PK 1215 TM</b>
				HYD-P	MTR-CODE: OM542.940; OE-NO.: 5419972892; MOD: 1846,L,LL;1850K;SA50516901	<b>8 PK 1215 TM</b>

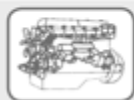

## MERCEDES-BENZ

### ACTROS MP2 / MP3

#### 1850; 1851

15928 ccm	370-375 kW	OM 542.940;OM 542.941;OM 542.960;OM 542.961	04.03 -	HYD-P	MTR-CODE: OM542.940; OE-NO.: 5419972892; MOD: 1846,L,LL;1850K;SA59902001/02	<b>8 PK 1215 TM</b>
				W-P	MTR-CODE: OM542.940; OE-NO.: 5419970992; MOD: 1846,L,LL;1850K;SA50516102	<b>9 PK 2835 TM</b>
		OM 542.940;OM 542.960		ALT; AC-C	MTR-CODE: OM 542.920	<b>KT 7004</b>
				ALT	MTR-CODE: OM542.940; OE-NO.: 5419972692; MOD: 1846,L,LL;1850K;SA50516110	<b>11 PK 1890 TM</b>
				ALT	MTR-CODE: OM542.940; OE-NO.: 5419972692; MOD: 1846,L,LL;1850K;SA50516901	<b>11 PK 1890 TM</b>
				ALT	MTR-CODE: OM542.940; OE-NO.: 5419972692; MOD: 1846,L,LL;1850K;SA59902001/02	<b>11 PK 1890 TM</b>
				ALT	MTR-CODE: OM542.940; OE-NO.: 5419972792; MOD: 1846,L,LL;1850K;SA50516111	<b>11 PK 2835 TM</b>
				ALT	MTR-CODE: OM542.940; OE-NO.: 5419972792; MOD: 1846,L,LL;1850K;SA59902001/02	<b>11 PK 2835 TM</b>
				FAN	MTR-CODE: OM542.940; OE-NO.: 5419970892; MOD: 1846,L,LL;1850K;SA50516101	<b>9 PK 1888 TM</b>
				HYD-P	MTR-CODE: OM542.940; OE-NO.: 0009938196; MOD: 1846,L,LL;1850K;SA50516118/19	<b>8 PK 1202 TM</b>
				HYD-P	MTR-CODE: OM542.940; OE-NO.: 5419972892; MOD: 1846,L,LL;1850K;SA50516110/11	<b>8 PK 1215 TM</b>
				HYD-P	MTR-CODE: OM542.940; OE-NO.: 5419972892; MOD: 1846,L,LL;1850K;SA50516901	<b>8 PK 1215 TM</b>
				HYD-P	MTR-CODE: OM542.940; OE-NO.: 5419972892; MOD: 1846,L,LL;1850K;SA59902001/02	<b>8 PK 1215 TM</b>
				W-P	MTR-CODE: OM542.940; OE-NO.: 5419970992; MOD: 1846,L,LL;1850K;SA50516102	<b>9 PK 2835 TM</b>
				ALT; AC-C	MTR-CODE: OM 541.920	<b>KT 7004</b>
				ALT; AC-C	MTR-CODE: OM 542.920	<b>KT 7004</b>

#### 1854

15928 ccm	395 kW	OM 542.942	04.03 -	ALT	MTR-CODE: OM542.940; OE-NO.: 5419972692; MOD: 1846,L,LL;1850K;SA50516110	<b>11 PK 1890 TM</b>
				ALT	MTR-CODE: OM542.940; OE-NO.: 5419972692; MOD: 1846,L,LL;1850K;SA50516901	<b>11 PK 1890 TM</b>
				ALT	MTR-CODE: OM542.940; OE-NO.: 5419972692; MOD: 1846,L,LL;1850K;SA59902001/02	<b>11 PK 1890 TM</b>
				ALT	MTR-CODE: OM542.940; OE-NO.: 5419972792; MOD: 1846,L,LL;1850K;SA50516111	<b>11 PK 2835 TM</b>
				ALT	MTR-CODE: OM542.940; OE-NO.: 5419972792; MOD: 1846,L,LL;1850K;SA59902001/02	<b>11 PK 2835 TM</b>
				FAN	MTR-CODE: OM542.940; OE-NO.: 5419970892; MOD: 1846,L,LL;1850K;SA50516101	<b>9 PK 1888 TM</b>
				HYD-P	MTR-CODE: OM542.940; OE-NO.: 0009938196; MOD: 1846,L,LL;1850K;SA50516118/19	<b>8 PK 1202 TM</b>
				HYD-P	MTR-CODE: OM542.940; OE-NO.: 5419972892; MOD: 1846,L,LL;1850K;SA50516110/11	<b>8 PK 1215 TM</b>
				HYD-P	MTR-CODE: OM542.940; OE-NO.: 5419972892; MOD: 1846,L,LL;1850K;SA50516901	<b>8 PK 1215 TM</b>
				HYD-P	MTR-CODE: OM542.940; OE-NO.: 5419972892; MOD: 1846,L,LL;1850K;SA59902001/02	<b>8 PK 1215 TM</b>
				W-P	MTR-CODE: OM542.940; OE-NO.: 5419970992; MOD: 1846,L,LL;1850K;SA50516102	<b>9 PK 2835 TM</b>
		395-405 kW		ALT; AC-C	MTR-CODE: OM 542.920	<b>KT 7004</b>
		OM 542.942;OM 542.962		ALT	MTR-CODE: OM542.940; OE-NO.: 5419972692; MOD: 1846,L,LL;1850K;SA50516110	<b>11 PK 1890 TM</b>
				ALT	MTR-CODE: OM542.940; OE-NO.: 5419972692; MOD: 1846,L,LL;1850K;SA50516901	<b>11 PK 1890 TM</b>
				ALT	MTR-CODE: OM542.940; OE-NO.: 5419972692; MOD: 1846,L,LL;1850K;SA59902001/02	<b>11 PK 1890 TM</b>
				ALT	MTR-CODE: OM542.940; OE-NO.: 5419972792; MOD: 1846,L,LL;1850K;SA50516111	<b>11 PK 2835 TM</b>
				ALT	MTR-CODE: OM542.940; OE-NO.: 5419972792; MOD: 1846,L,LL;1850K;SA59902001/02	<b>11 PK 2835 TM</b>
				FAN	MTR-CODE: OM542.940; OE-NO.: 5419970892; MOD: 1846,L,LL;1850K;SA50516101	<b>9 PK 1888 TM</b>
				HYD-P	MTR-CODE: OM542.940; OE-NO.: 0009938196; MOD: 1846,L,LL;1850K;SA50516118/19	<b>8 PK 1202 TM</b>
				HYD-P	MTR-CODE: OM542.940; OE-NO.: 5419972892; MOD: 1846,L,LL;1850K;SA50516110/11	<b>8 PK 1215 TM</b>
				HYD-P	MTR-CODE: OM542.940; OE-NO.: 5419972892; MOD: 1846,L,LL;1850K;SA50516901	<b>8 PK 1215 TM</b>
				HYD-P	MTR-CODE: OM542.940; OE-NO.: 5419972892; MOD: 1846,L,LL;1850K;SA59902001/02	<b>8 PK 1215 TM</b>



## MERCEDES-BENZ

### ACTROS MP2 / MP3

#### 1854

15928 ccm	395-405 kW	OM 542.942;OM 542.962	04.03 -	W-P	MTR-CODE: OM542.940; OE-NO.: 5419970992; MOD: 1846,L,LL;1850K;SA50516102	9 PK 2835 TM
				ALT; AC-C	MTR-CODE: OM 542.920	KT 7004

#### 1858

15928 ccm	425 kW	OM 542.944	10.02 -	ALT	FROM: 04.03; MTR-CODE: OM542.940; OE-NO.: 5419972692; MOD: 1846,L,LL;1850K;SA50516110	11 PK 1890 TM
				ALT	FROM: 04.03; MTR-CODE: OM542.940; OE-NO.: 5419972692; MOD: 1846,L,LL;1850K;SA50516901	11 PK 1890 TM
				ALT	FROM: 04.03; MTR-CODE: OM542.940; OE-NO.: 5419972692; MOD: 1846,L,LL;1850K;SA59902001/02	11 PK 1890 TM
				ALT	FROM: 04.03; MTR-CODE: OM542.940; OE-NO.: 5419972792; MOD: 1846,L,LL;1850K;SA50516111	11 PK 2835 TM
				ALT	FROM: 04.03; MTR-CODE: OM542.940; OE-NO.: 5419972792; MOD: 1846,L,LL;1850K;SA59902001/02	11 PK 2835 TM
				ALT	MTR-CODE: OM542.940; OE-NO.: 5419972692; MOD: 1846,L,LL;1850K;SA50516110	11 PK 1890 TM
				ALT	MTR-CODE: OM542.940; OE-NO.: 5419972692; MOD: 1846,L,LL;1850K;SA50516901	11 PK 1890 TM
				ALT	MTR-CODE: OM542.940; OE-NO.: 5419972692; MOD: 1846,L,LL;1850K;SA59902001/02	11 PK 1890 TM
				ALT	MTR-CODE: OM542.940; OE-NO.: 5419972792; MOD: 1846,L,LL;1850K;SA50516111	11 PK 2835 TM
				ALT	MTR-CODE: OM542.940; OE-NO.: 5419972792; MOD: 1846,L,LL;1850K;SA59902001/02	11 PK 2835 TM
				FAN	FROM: 04.03; MTR-CODE: OM542.940; OE-NO.: 5419970892; MOD: 1846,L,LL;1850K;SA50516101	9 PK 1888 TM
				FAN	MTR-CODE: OM542.940; OE-NO.: 5419970892; MOD: 1846,L,LL;1850K;SA50516101	9 PK 1888 TM
				HYD-P	FROM: 04.03; MTR-CODE: OM542.940; OE-NO.: 0009938196; MOD: 1846,L,LL;1850K;SA50516118/19	8 PK 1202 TM
				HYD-P	FROM: 04.03; MTR-CODE: OM542.940; OE-NO.: 5419972892; MOD: 1846,L,LL;1850K;SA50516110/11	8 PK 1215 TM
				HYD-P	FROM: 04.03; MTR-CODE: OM542.940; OE-NO.: 5419972892; MOD: 1846,L,LL;1850K;SA50516901	8 PK 1215 TM
				HYD-P	FROM: 04.03; MTR-CODE: OM542.940; OE-NO.: 5419972892; MOD: 1846,L,LL;1850K;SA59902001/02	8 PK 1215 TM
				HYD-P	MTR-CODE: OM542.940; OE-NO.: 0009938196; MOD: 1846,L,LL;1850K;SA50516118/19	8 PK 1202 TM
				HYD-P	MTR-CODE: OM542.940; OE-NO.: 5419972892; MOD: 1846,L,LL;1850K;SA50516110/11	8 PK 1215 TM
				HYD-P	MTR-CODE: OM542.940; OE-NO.: 5419972892; MOD: 1846,L,LL;1850K;SA50516901	8 PK 1215 TM
				HYD-P	MTR-CODE: OM542.940; OE-NO.: 5419972892; MOD: 1846,L,LL;1850K;SA59902001/02	8 PK 1215 TM
				W-P	FROM: 04.03; MTR-CODE: OM542.940; OE-NO.: 5419970992; MOD: 1846,L,LL;1850K;SA50516102	9 PK 2835 TM
				W-P	MTR-CODE: OM542.940; OE-NO.: 5419970992; MOD: 1846,L,LL;1850K;SA50516102	9 PK 2835 TM
				ALT; AC-C	MTR-CODE: OM 542.920	KT 7004

#### 2032

11946 ccm	230-235 kW	OM 541.920;OM 541.926;OM 541.940;OM 541.941;OM 541.997	04.03 -	ALT; AC-C	MTR-CODE: OM 541.920	KT 7004
		OM 541.920;OM 541.940		ALT; AC-C	MTR-CODE: OM 541.920	KT 7004
		OM 541.920;OM 541.940;OM 541.970;OM 541.996		ALT; AC-C	MTR-CODE: OM 541.920	KT 7004
		OM 541.926;OM 541.940;OM 541.941		ALT; AC-C	MTR-CODE: OM 541.920	KT 7004
		OM 541.926;OM 541.941		ALT; AC-C	MTR-CODE: OM 541.920	KT 7004

#### 2036

11946 ccm	260-265 kW	OM 541.922;OM 541.942	04.03 -	ALT; AC-C	MTR-CODE: OM 541.920	KT 7004
		OM 541.927;OM 541.942;OM 541.943		ALT; AC-C	MTR-CODE: OM 541.920	KT 7004

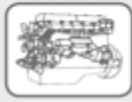

## MERCEDES-BENZ

### ACTROS MP2 / MP3

#### 2036

11946 ccm	260-265 kW	OM 541.927;OM 541.943 OM 541.942;OM 541.972	04.03 -	ALT; AC-C ALT; AC-C	MTR-CODE: OM 541.920 MTR-CODE: OM 541.920	KT 7004 KT 7004
-----------	------------	--	---------	------------------------	--	--------------------

#### 2041

11946 ccm	290-300 kW	OM 541.923;OM 541.944;OM 541.974 OM 541.923;OM 541.944;OM 541.974;OM 541.990 OM 541.924 OM 541.924;OM 541.944;OM 541.945;OM 541.991 OM 541.944;OM 541.974	04.03 -	ALT; AC-C ALT; AC-C ALT; AC-C ALT; AC-C ALT; AC-C	MTR-CODE: OM 541.920 MTR-CODE: OM 541.920 MTR-CODE: OM 541.920 MTR-CODE: OM 541.920 MTR-CODE: OM 541.920	KT 7004 KT 7004 KT 7004 KT 7004 KT 7004
-----------	------------	---	---------	---	--	---

#### 2044

11946 ccm	315-320 kW	OM 541.921;OM 541.947 OM 541.925;OM 541.946;OM 541.976 OM 541.946;OM 541.976	04.03 -	ALT; AC-C ALT; AC-C ALT; AC-C	MTR-CODE: OM 541.920 MTR-CODE: OM 541.920 MTR-CODE: OM 541.920	KT 7004 KT 7004 KT 7004
-----------	------------	--	---------	-------------------------------------	--	-------------------------------

#### 2046

11946 ccm	335 kW	OM 541.948;OM 541.980	04.03 -	ALT; AC-C	MTR-CODE: OM 541.920	KT 7004
-----------	--------	-----------------------	---------	-----------	----------------------	---------

#### 2050

15928 ccm	370 kW	OM 542.940;OM 542.941	04.03 -	ALT; AC-C	MTR-CODE: OM 542.920	KT 7004
-----------	--------	-----------------------	---------	-----------	----------------------	---------

#### 2532

11946 ccm	230-235 kW	OM 541.920;OM 541.940;OM 541.970;OM 541.996	04.03 -	ALT; AC-C	MTR-CODE: OM 541.920	KT 7004
-----------	------------	---	---------	-----------	----------------------	---------

#### 2536

11946 ccm	260-265 kW	OM 541.922;OM 541.942;OM 541.943;OM 541.972;OM 541.998	04.03 -	ALT; AC-C	MTR-CODE: OM 541.920	KT 7004
-----------	------------	--	---------	-----------	----------------------	---------

#### 2541

11946 ccm	290-300 kW	OM 541.923;OM 541.944;OM 541.974;OM 541.990	04.03 -	ALT; AC-C	MTR-CODE: OM 541.920	KT 7004
-----------	------------	---	---------	-----------	----------------------	---------

#### 2544

11946 ccm	315-320 kW	OM 541.925;OM 541.946;OM 541.976;OM 541.992	04.03 -	ALT; AC-C	MTR-CODE: OM 541.920	KT 7004
-----------	------------	---	---------	-----------	----------------------	---------

#### 2546

11946 ccm	335 kW	OM 541.948;OM 541.980;OM 541.994	04.03 -	ALT; AC-C	MTR-CODE: OM 541.920	KT 7004
-----------	--------	----------------------------------	---------	-----------	----------------------	---------

#### 2548

11946 ccm	350 kW	OM 541.948;OM 541.978	04.03 -	ALT; AC-C	MTR-CODE: OM 541.920	KT 7004
-----------	--------	-----------------------	---------	-----------	----------------------	---------

#### 2632

11946 ccm	235 kW	OM 541.940;OM 541.970;OM 541.996	04.03 -	ALT	MTR-CODE: OM541.940; OE-NO.: 0009938096; MOD: 2032A;SA50516119	11 PK 2871 TM
				ALT	MTR-CODE: OM541.940; OE-NO.: 0009938096; MOD: 2632K;2632LS;SA50516119	11 PK 2871 TM
				ALT	MTR-CODE: OM541.940; OE-NO.: 5419972692; MOD: 2032A;SA50516110	11 PK 1890 TM
				ALT	MTR-CODE: OM541.940; OE-NO.: 5419972692; MOD: 2032A;SA50516901	11 PK 1890 TM
				ALT	MTR-CODE: OM541.940; OE-NO.: 5419972692; MOD: 2032A;SA59902001/02	11 PK 1890 TM
				ALT	MTR-CODE: OM541.940; OE-NO.: 5419972692; MOD: 2632K;2632LS;SA50516110	11 PK 1890 TM
				ALT	MTR-CODE: OM541.940; OE-NO.: 5419972692; MOD: 2632K;2632LS;SA50516901	11 PK 1890 TM
				ALT	MTR-CODE: OM541.940; OE-NO.: 5419972692; MOD: 2632K;2632LS;SA59902001/02	11 PK 1890 TM
				ALT	MTR-CODE: OM541.940; OE-NO.: 5419972792; MOD: 2032A;SA50516111	11 PK 2835 TM
				ALT	MTR-CODE: OM541.940; OE-NO.: 5419972792; MOD: 2032A;SA59902001/02	11 PK 2835 TM
				ALT	MTR-CODE: OM541.940; OE-NO.: 5419972792; MOD: 2632K;2632LS;SA50516111	11 PK 2835 TM
				ALT	MTR-CODE: OM541.940; OE-NO.: 5419972792; MOD: 2632K;2632LS;SA59902001/02	11 PK 2835 TM
				ALT	OE-NO.: 0009938096; MOD: 2632K;2632LS;SA50516119	11 PK 2871 TM
				ALT	OE-NO.: 5419972692; MOD: 2632K;2632LS;SA50516110	11 PK 1890 TM
				ALT	OE-NO.: 5419972692; MOD: 2632K;2632LS;SA50516901	11 PK 1890 TM



## MERCEDES-BENZ

### ACTROS MP2 / MP3

#### 2632

11946 ccm	235 kW	OM 541.940;OM 541.970;OM 541.996	04.03 -	ALT	OE-NO.: 5419972692; MOD: 2632K;2632LS;SA59902001/02	11 PK 1890 TM
				ALT	OE-NO.: 5419972792; MOD: 2632K;2632LS;SA50516111	11 PK 2835 TM
				ALT	OE-NO.: 5419972792; MOD: 2632K;2632LS;SA59902001/02	11 PK 2835 TM
				FAN	MTR-CODE: OM541.940; OE-NO.: 0009937796; MOD: 2032A;SA50516116	9 PK 1920 TM
				FAN	MTR-CODE: OM541.940; OE-NO.: 0009937796; MOD: 2632K;2632LS;SA50516116	9 PK 1920 TM
				FAN	MTR-CODE: OM541.940; OE-NO.: 5419970892; MOD: 2032A;SA50516101	9 PK 1888 TM
				FAN	MTR-CODE: OM541.940; OE-NO.: 5419970892; MOD: 2632K;2632LS;SA50516101	9 PK 1888 TM
				FAN	MTR-CODE: OM541.940; OE-NO.: 5419972592; MOD: 2032A;SA50516109	12 PK 1515 TM
				FAN	MTR-CODE: OM541.940; OE-NO.: 5419972592; MOD: 2632K;2632LS;SA50516109	12 PK 1515 TM
				FAN	MTR-CODE: OM541.940; OE-NO.: 5419973092; MOD: 2032A;SA50516115	12 PK 1507 TM
				FAN	MTR-CODE: OM541.940; OE-NO.: 5419973092; MOD: 2632K;2632LS;SA50516115	12 PK 1507 TM
				FAN	OE-NO.: 0009937796; MOD: 2632K;2632LS;SA50516116	9 PK 1920 TM
				FAN	OE-NO.: 5419970892; MOD: 2632K;2632LS;SA50516101	9 PK 1888 TM
				FAN	OE-NO.: 5419972592; MOD: 2632K;2632LS;SA50516109	12 PK 1515 TM
				FAN	OE-NO.: 5419973092; MOD: 2632K;2632LS;SA50516115	12 PK 1507 TM
				HYD-P	MTR-CODE: OM541.940; OE-NO.: 0009938196; MOD: 2032A;SA50516118/19	8 PK 1202 TM
				HYD-P	MTR-CODE: OM541.940; OE-NO.: 0009938196; MOD: 2632K;2632LS;SA50516118/19	8 PK 1202 TM
				HYD-P	MTR-CODE: OM541.940; OE-NO.: 5419972892; MOD: 2032A;SA50516110/11	8 PK 1215 TM
				HYD-P	MTR-CODE: OM541.940; OE-NO.: 5419972892; MOD: 2032A;SA50516901	8 PK 1215 TM
				HYD-P	MTR-CODE: OM541.940; OE-NO.: 5419972892; MOD: 2032A;SA59902001/02	8 PK 1215 TM
				HYD-P	MTR-CODE: OM541.940; OE-NO.: 5419972892; MOD: 2632K;2632LS;SA50516110/11	8 PK 1215 TM
				HYD-P	MTR-CODE: OM541.940; OE-NO.: 5419972892; MOD: 2632K;2632LS;SA50516901	8 PK 1215 TM
				HYD-P	MTR-CODE: OM541.940; OE-NO.: 5419972892; MOD: 2632K;2632LS;SA59902001/02	8 PK 1215 TM
				HYD-P	OE-NO.: 0009938196; MOD: 2632K;2632LS;SA50516118/19	8 PK 1202 TM
				HYD-P	OE-NO.: 5419972892; MOD: 2632K;2632LS;SA50516110/11	8 PK 1215 TM
				HYD-P	OE-NO.: 5419972892; MOD: 2632K;2632LS;SA50516901	8 PK 1215 TM
				HYD-P	OE-NO.: 5419972892; MOD: 2632K;2632LS;SA59902001/02	8 PK 1215 TM
				W-P	MTR-CODE: OM541.940; OE-NO.: 0009937896; MOD: 2032A;SA50516117	9 PK 2871 TM
				W-P	MTR-CODE: OM541.940; OE-NO.: 0009937896; MOD: 2632K;2632LS;SA50516117	9 PK 2871 TM
				W-P	MTR-CODE: OM541.940; OE-NO.: 5419970992; MOD: 2032A;SA50516102	9 PK 2835 TM
				W-P	MTR-CODE: OM541.940; OE-NO.: 5419970992; MOD: 2632K;2632LS;SA50516102	9 PK 2835 TM
				W-P	MTR-CODE: OM541.940; OE-NO.: 5419971092; MOD: 2032A;SA50516103	9 PK 2295 TM
				W-P	MTR-CODE: OM541.940; OE-NO.: 5419971092; MOD: 2632K;2632LS;SA50516103	9 PK 2295 TM
				W-P	OE-NO.: 0009937896; MOD: 2632K;2632LS;SA50516117	9 PK 2871 TM
				W-P	OE-NO.: 5419970992; MOD: 2632K;2632LS;SA50516102	9 PK 2835 TM
				W-P	OE-NO.: 5419971092; MOD: 2632K;2632LS;SA50516103	9 PK 2295 TM
				ALT; AC-C	MTR-CODE: OM 541.920	KT 7004

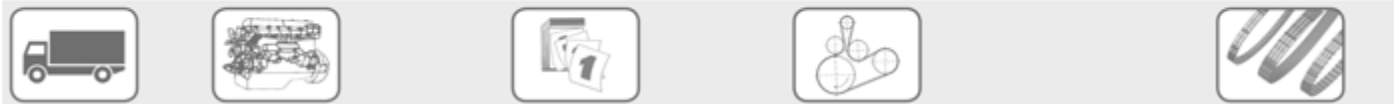

## MERCEDES-BENZ

### ACTROS MP2 / MP3

#### 2636

11946 ccm	265 kW	OM 541.942;OM 541.972;OM 541.998	04.03 -	ALT	MTR-CODE: OM541.940; OE-NO.: 0009938096; MOD: 2632K;2632LS;SA50516119	11 PK 2871 TM
				ALT	MTR-CODE: OM541.940; OE-NO.: 5419972692; MOD: 2632K;2632LS;SA50516110	11 PK 1890 TM
				ALT	MTR-CODE: OM541.940; OE-NO.: 5419972692; MOD: 2632K;2632LS;SA50516901	11 PK 1890 TM
				ALT	MTR-CODE: OM541.940; OE-NO.: 5419972692; MOD: 2632K;2632LS;SA59902001/02	11 PK 1890 TM
				ALT	MTR-CODE: OM541.940; OE-NO.: 5419972792; MOD: 2632K;2632LS;SA50516111	11 PK 2835 TM
				ALT	MTR-CODE: OM541.940; OE-NO.: 5419972792; MOD: 2632K;2632LS;SA59902001/02	11 PK 2835 TM
				FAN	MTR-CODE: OM541.940; OE-NO.: 0009937796; MOD: 2632K;2632LS;SA50516116	9 PK 1920 TM
				FAN	MTR-CODE: OM541.940; OE-NO.: 5419970892; MOD: 2632K;2632LS;SA50516101	9 PK 1888 TM
				FAN	MTR-CODE: OM541.940; OE-NO.: 5419972592; MOD: 2632K;2632LS;SA50516109	12 PK 1515 TM
				FAN	MTR-CODE: OM541.940; OE-NO.: 5419973092; MOD: 2632K;2632LS;SA50516115	12 PK 1507 TM
				HYD-P	MTR-CODE: OM541.940; OE-NO.: 0009938196; MOD: 2632K;2632LS;SA50516118/19	8 PK 1202 TM
				HYD-P	MTR-CODE: OM541.940; OE-NO.: 5419972892; MOD: 2632K;2632LS;SA50516110/11	8 PK 1215 TM
				HYD-P	MTR-CODE: OM541.940; OE-NO.: 5419972892; MOD: 2632K;2632LS;SA50516901	8 PK 1215 TM
				HYD-P	MTR-CODE: OM541.940; OE-NO.: 5419972892; MOD: 2632K;2632LS;SA59902001/02	8 PK 1215 TM
				W-P	MTR-CODE: OM541.940; OE-NO.: 0009937896; MOD: 2632K;2632LS;SA50516117	9 PK 2871 TM
				W-P	MTR-CODE: OM541.940; OE-NO.: 5419970992; MOD: 2632K;2632LS;SA50516102	9 PK 2835 TM
				W-P	MTR-CODE: OM541.940; OE-NO.: 5419971092; MOD: 2632K;2632LS;SA50516103	9 PK 2295 TM
				ALT; AC-C	MTR-CODE: OM 541.920	KT 7004

#### 2641

11946 ccm	300 kW	OM 541.944;OM 541.974;OM 541.990	04.03 -	ALT	MTR-CODE: OM541.940; OE-NO.: 0009938096; MOD: 2632K;2632LS;SA50516119	11 PK 2871 TM
				ALT	MTR-CODE: OM541.940; OE-NO.: 5419972692; MOD: 2632K;2632LS;SA50516110	11 PK 1890 TM
				ALT	MTR-CODE: OM541.940; OE-NO.: 5419972692; MOD: 2632K;2632LS;SA50516901	11 PK 1890 TM
				ALT	MTR-CODE: OM541.940; OE-NO.: 5419972692; MOD: 2632K;2632LS;SA59902001/02	11 PK 1890 TM
				ALT	MTR-CODE: OM541.940; OE-NO.: 5419972792; MOD: 2632K;2632LS;SA50516111	11 PK 2835 TM
				ALT	MTR-CODE: OM541.940; OE-NO.: 5419972792; MOD: 2632K;2632LS;SA59902001/02	11 PK 2835 TM
				FAN	MTR-CODE: OM541.940; OE-NO.: 0009937796; MOD: 2632K;2632LS;SA50516116	9 PK 1920 TM
				FAN	MTR-CODE: OM541.940; OE-NO.: 5419970892; MOD: 2632K;2632LS;SA50516101	9 PK 1888 TM
				FAN	MTR-CODE: OM541.940; OE-NO.: 5419972592; MOD: 2632K;2632LS;SA50516109	12 PK 1515 TM
				FAN	MTR-CODE: OM541.940; OE-NO.: 5419973092; MOD: 2632K;2632LS;SA50516115	12 PK 1507 TM
				HYD-P	MTR-CODE: OM541.940; OE-NO.: 0009938196; MOD: 2632K;2632LS;SA50516118/19	8 PK 1202 TM
				HYD-P	MTR-CODE: OM541.940; OE-NO.: 5419972892; MOD: 2632K;2632LS;SA50516110/11	8 PK 1215 TM
				HYD-P	MTR-CODE: OM541.940; OE-NO.: 5419972892; MOD: 2632K;2632LS;SA50516901	8 PK 1215 TM
				HYD-P	MTR-CODE: OM541.940; OE-NO.: 5419972892; MOD: 2632K;2632LS;SA59902001/02	8 PK 1215 TM
				W-P	MTR-CODE: OM541.940; OE-NO.: 0009937896; MOD: 2632K;2632LS;SA50516117	9 PK 2871 TM
				W-P	MTR-CODE: OM541.940; OE-NO.: 5419970992; MOD: 2632K;2632LS;SA50516102	9 PK 2835 TM
				W-P	MTR-CODE: OM541.940; OE-NO.: 5419971092; MOD: 2632K;2632LS;SA50516103	9 PK 2295 TM
				ALT; AC-C	MTR-CODE: OM 541.920	KT 7004

#### 2644

11946 ccm	315-320 kW	OM 541.925;OM 541.946;OM 541.976;OM 541.992	04.03 -	ALT	MTR-CODE: OM541.940; OE-NO.: 0009938096; MOD: 2632K;2632LS;SA50516119	11 PK 2871 TM
-----------	------------	---	---------	-----	---	---------------

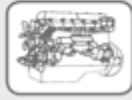

## MERCEDES-BENZ

### ACTROS MP2 / MP3

#### 2644

11946 ccm	315-320 kW	OM 541.925;OM 541.946;OM 541.976;OM 541.992	04.03 -	ALT	MTR-CODE: OM541.940; OE-NO.: 5419972692; MOD: 2632K;2632LS;SA50516110	<b>11 PK 1890 TM</b>
				ALT	MTR-CODE: OM541.940; OE-NO.: 5419972692; MOD: 2632K;2632LS;SA50516901	<b>11 PK 1890 TM</b>
				ALT	MTR-CODE: OM541.940; OE-NO.: 5419972692; MOD: 2632K;2632LS;SA59902001/02	<b>11 PK 1890 TM</b>
				ALT	MTR-CODE: OM541.940; OE-NO.: 5419972792; MOD: 2632K;2632LS;SA50516111	<b>11 PK 2835 TM</b>
				ALT	MTR-CODE: OM541.940; OE-NO.: 5419972792; MOD: 2632K;2632LS;SA59902001/02	<b>11 PK 2835 TM</b>
				FAN	MTR-CODE: OM541.940; OE-NO.: 0009937796; MOD: 2632K;2632LS;SA50516116	<b>9 PK 1920 TM</b>
				FAN	MTR-CODE: OM541.940; OE-NO.: 5419970892; MOD: 2632K;2632LS;SA50516101	<b>9 PK 1888 TM</b>
				FAN	MTR-CODE: OM541.940; OE-NO.: 5419972592; MOD: 2632K;2632LS;SA50516109	<b>12 PK 1515 TM</b>
				FAN	MTR-CODE: OM541.940; OE-NO.: 5419973092; MOD: 2632K;2632LS;SA50516115	<b>12 PK 1507 TM</b>
				HYD-P	MTR-CODE: OM541.940; OE-NO.: 0009938196; MOD: 2632K;2632LS;SA50516118/19	<b>8 PK 1202 TM</b>
				HYD-P	MTR-CODE: OM541.940; OE-NO.: 5419972892; MOD: 2632K;2632LS;SA50516110/11	<b>8 PK 1215 TM</b>
				HYD-P	MTR-CODE: OM541.940; OE-NO.: 5419972892; MOD: 2632K;2632LS;SA50516901	<b>8 PK 1215 TM</b>
				HYD-P	MTR-CODE: OM541.940; OE-NO.: 5419972892; MOD: 2632K;2632LS;SA59902001/02	<b>8 PK 1215 TM</b>
				W-P	MTR-CODE: OM541.940; OE-NO.: 0009937896; MOD: 2632K;2632LS;SA50516117	<b>9 PK 2871 TM</b>
				W-P	MTR-CODE: OM541.940; OE-NO.: 5419970992; MOD: 2632K;2632LS;SA50516102	<b>9 PK 2835 TM</b>
				W-P	MTR-CODE: OM541.940; OE-NO.: 5419971092; MOD: 2632K;2632LS;SA50516103	<b>9 PK 2295 TM</b>
				ALT; AC-C	MTR-CODE: OM 541.920	<b>KT 7004</b>
320 kW		OM 541.946;OM 541.976;OM 541.992		ALT	MTR-CODE: OM541.940; OE-NO.: 0009938096; MOD: 2632K;2632LS;SA50516119	<b>11 PK 2871 TM</b>
				ALT	MTR-CODE: OM541.940; OE-NO.: 5419972692; MOD: 2632K;2632LS;SA50516110	<b>11 PK 1890 TM</b>
				ALT	MTR-CODE: OM541.940; OE-NO.: 5419972692; MOD: 2632K;2632LS;SA50516901	<b>11 PK 1890 TM</b>
				ALT	MTR-CODE: OM541.940; OE-NO.: 5419972692; MOD: 2632K;2632LS;SA59902001/02	<b>11 PK 1890 TM</b>
				ALT	MTR-CODE: OM541.940; OE-NO.: 5419972792; MOD: 2632K;2632LS;SA50516111	<b>11 PK 2835 TM</b>
				ALT	MTR-CODE: OM541.940; OE-NO.: 5419972792; MOD: 2632K;2632LS;SA59902001/02	<b>11 PK 2835 TM</b>
				FAN	MTR-CODE: OM541.940; OE-NO.: 0009937796; MOD: 2632K;2632LS;SA50516116	<b>9 PK 1920 TM</b>
				FAN	MTR-CODE: OM541.940; OE-NO.: 5419970892; MOD: 2632K;2632LS;SA50516101	<b>9 PK 1888 TM</b>
				FAN	MTR-CODE: OM541.940; OE-NO.: 5419972592; MOD: 2632K;2632LS;SA50516109	<b>12 PK 1515 TM</b>
				FAN	MTR-CODE: OM541.940; OE-NO.: 5419973092; MOD: 2632K;2632LS;SA50516115	<b>12 PK 1507 TM</b>
				HYD-P	MTR-CODE: OM541.940; OE-NO.: 0009938196; MOD: 2632K;2632LS;SA50516118/19	<b>8 PK 1202 TM</b>
				HYD-P	MTR-CODE: OM541.940; OE-NO.: 5419972892; MOD: 2632K;2632LS;SA50516110/11	<b>8 PK 1215 TM</b>
				HYD-P	MTR-CODE: OM541.940; OE-NO.: 5419972892; MOD: 2632K;2632LS;SA50516901	<b>8 PK 1215 TM</b>
				HYD-P	MTR-CODE: OM541.940; OE-NO.: 5419972892; MOD: 2632K;2632LS;SA59902001/02	<b>8 PK 1215 TM</b>
				W-P	MTR-CODE: OM541.940; OE-NO.: 0009937896; MOD: 2632K;2632LS;SA50516117	<b>9 PK 2871 TM</b>
				W-P	MTR-CODE: OM541.940; OE-NO.: 5419970992; MOD: 2632K;2632LS;SA50516102	<b>9 PK 2835 TM</b>
				W-P	MTR-CODE: OM541.940; OE-NO.: 5419971092; MOD: 2632K;2632LS;SA50516103	<b>9 PK 2295 TM</b>
				ALT; AC-C	MTR-CODE: OM 541.920	<b>KT 7004</b>

#### 2646

11946 ccm	335 kW	OM 541.948;OM 541.980;OM 541.994	04.03 -	ALT	MTR-CODE: OM541.940; OE-NO.: 0009938096; MOD: 2632K;2632LS;SA50516119	<b>11 PK 2871 TM</b>
				ALT	MTR-CODE: OM541.940; OE-NO.: 5419972692; MOD: 2632K;2632LS;SA50516110	<b>11 PK 1890 TM</b>



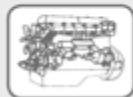

## MERCEDES-BENZ

### ACTROS MP2 / MP3

#### 2646

11946 ccm	335 kW	OM 541.948;OM 541.980;OM 541.994	04.03 -	ALT	MTR-CODE: OM541.940; OE-NO.: 5419972692; MOD: 2632K;2632LS;SA50516901	11 PK 1890 TM
				ALT	MTR-CODE: OM541.940; OE-NO.: 5419972692; MOD: 2632K;2632LS;SA59902001/02	11 PK 1890 TM
				ALT	MTR-CODE: OM541.940; OE-NO.: 5419972792; MOD: 2632K;2632LS;SA50516111	11 PK 2835 TM
				ALT	MTR-CODE: OM541.940; OE-NO.: 5419972792; MOD: 2632K;2632LS;SA59902001/02	11 PK 2835 TM
				FAN	MTR-CODE: OM541.940; OE-NO.: 0009937796; MOD: 2632K;2632LS;SA50516116	9 PK 1920 TM
				FAN	MTR-CODE: OM541.940; OE-NO.: 5419970892; MOD: 2632K;2632LS;SA50516101	9 PK 1888 TM
				FAN	MTR-CODE: OM541.940; OE-NO.: 5419972592; MOD: 2632K;2632LS;SA50516109	12 PK 1515 TM
				FAN	MTR-CODE: OM541.940; OE-NO.: 5419973092; MOD: 2632K;2632LS;SA50516115	12 PK 1507 TM
				HYD-P	MTR-CODE: OM541.940; OE-NO.: 0009938196; MOD: 2632K;2632LS;SA50516118/19	8 PK 1202 TM
				HYD-P	MTR-CODE: OM541.940; OE-NO.: 5419972892; MOD: 2632K;2632LS;SA50516110/11	8 PK 1215 TM
				HYD-P	MTR-CODE: OM541.940; OE-NO.: 5419972892; MOD: 2632K;2632LS;SA50516901	8 PK 1215 TM
				HYD-P	MTR-CODE: OM541.940; OE-NO.: 5419972892; MOD: 2632K;2632LS;SA59902001/02	8 PK 1215 TM
				W-P	MTR-CODE: OM541.940; OE-NO.: 0009937896; MOD: 2632K;2632LS;SA50516117	9 PK 2871 TM
				W-P	MTR-CODE: OM541.940; OE-NO.: 5419970992; MOD: 2632K;2632LS;SA50516102	9 PK 2835 TM
				W-P	MTR-CODE: OM541.940; OE-NO.: 5419971092; MOD: 2632K;2632LS;SA50516103	9 PK 2295 TM
				ALT; AC-C	MTR-CODE: OM 541.920	KT 7004

#### 2650

15928 ccm	370 kW	OM 542.940	04.03 -	ALT	OE-NO.: 5419972692; MOD: 2650K;2650S,LS;SA50516110	11 PK 1890 TM
				ALT	OE-NO.: 5419972692; MOD: 2650K;2650S,LS;SA50516901	11 PK 1890 TM
				ALT	OE-NO.: 5419972692; MOD: 2650K;2650S,LS;SA59902001/02	11 PK 1890 TM
				ALT	OE-NO.: 5419972792; MOD: 2650K;2650S,LS;SA50516111	11 PK 2835 TM
				ALT	OE-NO.: 5419972792; MOD: 2650K;2650S,LS;SA59902001/02	11 PK 2835 TM
				FAN	OE-NO.: 5419970892; MOD: 2650K;2650S,LS;SA50516101	9 PK 1888 TM
				FAN	OE-NO.: 5419972592; MOD: 2650K;2650S,LS;SA50516109	12 PK 1515 TM
				HYD-P	OE-NO.: 0009938196; MOD: 2650K;2650S,LS;SA50516118/19	8 PK 1202 TM
				HYD-P	OE-NO.: 5419972892; MOD: 2650K;2650S,LS;SA50516110/11	8 PK 1215 TM
				HYD-P	OE-NO.: 5419972892; MOD: 2650K;2650S,LS;SA50516901	8 PK 1215 TM
				HYD-P	OE-NO.: 5419972892; MOD: 2650K;2650S,LS;SA59902001/02	8 PK 1215 TM
				W-P	OE-NO.: 5419970992; MOD: 2650K;2650S,LS;SA50516102	9 PK 2835 TM
				W-P	OE-NO.: 5419971092; MOD: 2650K;2650S,LS;SA50516103	9 PK 2295 TM
				ALT; AC-C	MTR-CODE: OM 542.920	KT 7004

#### 2650; 2651

15928 ccm	370-375 kW	OM 542.940	04.03 -	ALT	OE-NO.: 5419972692; MOD: 2650K;2650S,LS;SA50516110	11 PK 1890 TM
				ALT	OE-NO.: 5419972692; MOD: 2650K;2650S,LS;SA50516901	11 PK 1890 TM
				ALT	OE-NO.: 5419972692; MOD: 2650K;2650S,LS;SA59902001/02	11 PK 1890 TM
				ALT	OE-NO.: 5419972792; MOD: 2650K;2650S,LS;SA50516111	11 PK 2835 TM
				ALT	OE-NO.: 5419972792; MOD: 2650K;2650S,LS;SA59902001/02	11 PK 2835 TM
				FAN	OE-NO.: 5419970892; MOD: 2650K;2650S,LS;SA50516101	9 PK 1888 TM
				FAN	OE-NO.: 5419972592; MOD: 2650K;2650S,LS;SA50516109	12 PK 1515 TM



## MERCEDES-BENZ

### ACTROS MP2 / MP3

#### 2650; 2651

15928 ccm	370-375 kW	OM 542.940	04.03 -	HYD-P	OE-NO.: 0009938196; MOD: 2650K;2650S,LS;SA50516118/19	8 PK 1202 TM
				HYD-P	OE-NO.: 5419972892; MOD: 2650K;2650S,LS;SA50516110/11	8 PK 1215 TM
				HYD-P	OE-NO.: 5419972892; MOD: 2650K;2650S,LS;SA50516901	8 PK 1215 TM
				HYD-P	OE-NO.: 5419972892; MOD: 2650K;2650S,LS;SA59902001/02	8 PK 1215 TM
				W-P	OE-NO.: 5419970992; MOD: 2650K;2650S,LS;SA50516102	9 PK 2835 TM
				W-P	OE-NO.: 5419971092; MOD: 2650K;2650S,LS;SA50516103	9 PK 2295 TM
				ALT; AC-C	MTR-CODE: OM 542.920	KT 7004
	OM 542.940;OM 542.960			ALT	MTR-CODE: OM542.940; OE-NO.: 5419972692; MOD: 2650K;2650S,LS;SA50516110	11 PK 1890 TM
				ALT	MTR-CODE: OM542.940; OE-NO.: 5419972692; MOD: 2650K;2650S,LS;SA50516901	11 PK 1890 TM
				ALT	MTR-CODE: OM542.940; OE-NO.: 5419972692; MOD: 2650K;2650S,LS;SA59902001/02	11 PK 1890 TM
				ALT	MTR-CODE: OM542.940; OE-NO.: 5419972792; MOD: 2650K;2650S,LS;SA50516111	11 PK 2835 TM
				ALT	MTR-CODE: OM542.940; OE-NO.: 5419972792; MOD: 2650K;2650S,LS;SA59902001/02	11 PK 2835 TM
				FAN	MTR-CODE: OM542.940; OE-NO.: 5419970892; MOD: 2650K;2650S,LS;SA50516101	9 PK 1888 TM
				FAN	MTR-CODE: OM542.940; OE-NO.: 5419972592; MOD: 2650K;2650S,LS;SA50516109	12 PK 1515 TM
				HYD-P	MTR-CODE: OM542.940; OE-NO.: 0009938196; MOD: 2650K;2650S,LS;SA50516118/19	8 PK 1202 TM
				HYD-P	MTR-CODE: OM542.940; OE-NO.: 5419972892; MOD: 2650K;2650S,LS;SA50516110/11	8 PK 1215 TM
				HYD-P	MTR-CODE: OM542.940; OE-NO.: 5419972892; MOD: 2650K;2650S,LS;SA50516901	8 PK 1215 TM
				HYD-P	MTR-CODE: OM542.940; OE-NO.: 5419972892; MOD: 2650K;2650S,LS;SA59902001/02	8 PK 1215 TM
				W-P	MTR-CODE: OM542.940; OE-NO.: 5419970992; MOD: 2650K;2650S,LS;SA50516102	9 PK 2835 TM
				W-P	MTR-CODE: OM542.940; OE-NO.: 5419971092; MOD: 2650K;2650S,LS;SA50516103	9 PK 2295 TM
				ALT; AC-C	MTR-CODE: OM 542.920	KT 7004

#### 2654

15928 ccm	390-395 kW	OM 542.920;OM 542.942	04.03 -	ALT	MTR-CODE: OM542.940; OE-NO.: 5419972692; MOD: 2650K;2650S,LS;SA50516110	11 PK 1890 TM
				ALT	MTR-CODE: OM542.940; OE-NO.: 5419972692; MOD: 2650K;2650S,LS;SA50516901	11 PK 1890 TM
				ALT	MTR-CODE: OM542.940; OE-NO.: 5419972692; MOD: 2650K;2650S,LS;SA59902001/02	11 PK 1890 TM
				ALT	MTR-CODE: OM542.940; OE-NO.: 5419972792; MOD: 2650K;2650S,LS;SA50516111	11 PK 2835 TM
				ALT	MTR-CODE: OM542.940; OE-NO.: 5419972792; MOD: 2650K;2650S,LS;SA59902001/02	11 PK 2835 TM
				FAN	MTR-CODE: OM542.940; OE-NO.: 5419970892; MOD: 2650K;2650S,LS;SA50516101	9 PK 1888 TM
				FAN	MTR-CODE: OM542.940; OE-NO.: 5419972592; MOD: 2650K;2650S,LS;SA50516109	12 PK 1515 TM
				HYD-P	MTR-CODE: OM542.940; OE-NO.: 0009938196; MOD: 2650K;2650S,LS;SA50516118/19	8 PK 1202 TM
				HYD-P	MTR-CODE: OM542.940; OE-NO.: 5419972892; MOD: 2650K;2650S,LS;SA50516110/11	8 PK 1215 TM
				HYD-P	MTR-CODE: OM542.940; OE-NO.: 5419972892; MOD: 2650K;2650S,LS;SA50516901	8 PK 1215 TM
				HYD-P	MTR-CODE: OM542.940; OE-NO.: 5419972892; MOD: 2650K;2650S,LS;SA59902001/02	8 PK 1215 TM
				W-P	MTR-CODE: OM542.940; OE-NO.: 5419970992; MOD: 2650K;2650S,LS;SA50516102	9 PK 2835 TM
				W-P	MTR-CODE: OM542.940; OE-NO.: 5419971092; MOD: 2650K;2650S,LS;SA50516103	9 PK 2295 TM
				ALT; AC-C	MTR-CODE: OM 542.920	KT 7004

#### 2654; 2655

15928 ccm	395-405 kW	OM 542.942;OM 542.962	04.03 -	ALT	MTR-CODE: OM542.940; OE-NO.: 5419972692; MOD: 2650K;2650S,LS;SA50516110	11 PK 1890 TM
				ALT	MTR-CODE: OM542.940; OE-NO.: 5419972692; MOD: 2650K;2650S,LS;SA50516901	11 PK 1890 TM



## MERCEDES-BENZ

### ACTROS MP2 / MP3

#### 2654; 2655

15928 ccm	395-405 kW	OM 542.942;OM 542.962	04.03 -	ALT	MTR-CODE: OM542.940; OE-NO.: 5419972692; MOD: 2650K;2650S,LS;SA59902001/02	11 PK 1890 TM
				ALT	MTR-CODE: OM542.940; OE-NO.: 5419972792; MOD: 2650K;2650S,LS;SA50516111	11 PK 2835 TM
				ALT	MTR-CODE: OM542.940; OE-NO.: 5419972792; MOD: 2650K;2650S,LS;SA59902001/02	11 PK 2835 TM
				FAN	MTR-CODE: OM542.940; OE-NO.: 5419970892; MOD: 2650K;2650S,LS;SA50516101	9 PK 1888 TM
				FAN	MTR-CODE: OM542.940; OE-NO.: 5419972592; MOD: 2650K;2650S,LS;SA50516109	12 PK 1515 TM
				HYD-P	MTR-CODE: OM542.940; OE-NO.: 0009938196; MOD: 2650K;2650S,LS;SA50516118/19	8 PK 1202 TM
				HYD-P	MTR-CODE: OM542.940; OE-NO.: 5419972892; MOD: 2650K;2650S,LS;SA50516110/11	8 PK 1215 TM
				HYD-P	MTR-CODE: OM542.940; OE-NO.: 5419972892; MOD: 2650K;2650S,LS;SA50516901	8 PK 1215 TM
				HYD-P	MTR-CODE: OM542.940; OE-NO.: 5419972892; MOD: 2650K;2650S,LS;SA59902001/02	8 PK 1215 TM
				W-P	MTR-CODE: OM542.940; OE-NO.: 5419970992; MOD: 2650K;2650S,LS;SA50516102	9 PK 2835 TM
				W-P	MTR-CODE: OM542.940; OE-NO.: 5419971092; MOD: 2650K;2650S,LS;SA50516103	9 PK 2295 TM
				ALT; AC-C	MTR-CODE: OM 542.920	KT 7004

#### 2658

15928 ccm	425 kW	OM 542.944	04.03 -	ALT	MTR-CODE: OM542.940; OE-NO.: 5419972692; MOD: 2650K;2650S,LS;SA50516110	11 PK 1890 TM
				ALT	MTR-CODE: OM542.940; OE-NO.: 5419972692; MOD: 2650K;2650S,LS;SA50516901	11 PK 1890 TM
				ALT	MTR-CODE: OM542.940; OE-NO.: 5419972692; MOD: 2650K;2650S,LS;SA59902001/02	11 PK 1890 TM
				ALT	MTR-CODE: OM542.940; OE-NO.: 5419972792; MOD: 2650K;2650S,LS;SA50516111	11 PK 2835 TM
				ALT	MTR-CODE: OM542.940; OE-NO.: 5419972792; MOD: 2650K;2650S,LS;SA59902001/02	11 PK 2835 TM
				FAN	MTR-CODE: OM542.940; OE-NO.: 5419970892; MOD: 2650K;2650S,LS;SA50516101	9 PK 1888 TM
				FAN	MTR-CODE: OM542.940; OE-NO.: 5419972592; MOD: 2650K;2650S,LS;SA50516109	12 PK 1515 TM
				HYD-P	MTR-CODE: OM542.940; OE-NO.: 0009938196; MOD: 2650K;2650S,LS;SA50516118/19	8 PK 1202 TM
				HYD-P	MTR-CODE: OM542.940; OE-NO.: 5419972892; MOD: 2650K;2650S,LS;SA50516110/11	8 PK 1215 TM
				HYD-P	MTR-CODE: OM542.940; OE-NO.: 5419972892; MOD: 2650K;2650S,LS;SA50516901	8 PK 1215 TM
				HYD-P	MTR-CODE: OM542.940; OE-NO.: 5419972892; MOD: 2650K;2650S,LS;SA59902001/02	8 PK 1215 TM
				W-P	MTR-CODE: OM542.940; OE-NO.: 5419970992; MOD: 2650K;2650S,LS;SA50516102	9 PK 2835 TM
				W-P	MTR-CODE: OM542.940; OE-NO.: 5419971092; MOD: 2650K;2650S,LS;SA50516103	9 PK 2295 TM
				ALT; AC-C	MTR-CODE: OM 542.920	KT 7004

#### 3231; 3232

11946 ccm	230-235 kW	OM 541.920;OM 541.940;OM 541.970;OM 541.996	04.03 -	ALT; AC-C	MTR-CODE: OM 541.920	KT 7004
-----------	------------	---	---------	-----------	----------------------	---------

#### 3241

11946 ccm	300 kW	OM 541.944;OM 541.974;OM 541.990	04.03 -	ALT; AC-C	MTR-CODE: OM 541.920	KT 7004
-----------	--------	----------------------------------	---------	-----------	----------------------	---------

#### 3331; 3332

11946 ccm	230-235 kW	OM 541.920;OM 541.926;OM 541.940	04.03 -	ALT; AC-C	MTR-CODE: OM 541.920	KT 7004
		OM 541.920;OM 541.926;OM 541.940;OM 541.941;OM 541.971;OM 541.997		ALT; AC-C	MTR-CODE: OM 541.920	KT 7004
		OM 541.920;OM 541.940		ALT; AC-C	MTR-CODE: OM 541.920	KT 7004

#### 3332

11946 ccm	230-235 kW	OM 541.920;OM 541.940;OM 541.970;OM 541.996	10.02 -	ALT; AC-C	MTR-CODE: OM 541.920	KT 7004
-----------	------------	---	---------	-----------	----------------------	---------

#### 3336

11946 ccm	260-265 kW	OM 541.942	10.02 -	ALT; AC-C	MTR-CODE: OM 541.920	KT 7004
	265 kW	OM 541.942;OM 541.943;OM 541.973;OM 541.999		ALT; AC-C	MTR-CODE: OM 541.920	KT 7004
		OM 541.942;OM 541.972		ALT; AC-C	MTR-CODE: OM 541.920	KT 7004

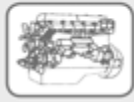

## MERCEDES-BENZ

### ACTROS MP2 / MP3

<b>3341</b>	11946 ccm	300 kW	OM 541.944;OM 541.974	10.02 -	ALT; AC-C	MTR-CODE: OM 541.920	<b>KT 7004</b>
<b>3344</b>	11946 ccm	315-320 kW	OM 541.946;OM 541.947	10.02 -	ALT; AC-C	MTR-CODE: OM 541.920	<b>KT 7004</b>
<b>3346</b>	11946 ccm	335 kW	OM 541.948	10.02 -	ALT; AC-C	MTR-CODE: OM 541.920	<b>KT 7004</b>
<b>3348</b>	15928 ccm	350 kW	OM 542.921	10.02 -	ALT; AC-C	MTR-CODE: OM 541.920	<b>KT 7004</b>
<b>3350; 3351</b>	15928 ccm	370-375 kW	OM 542.940;OM 542.960	04.03 -	ALT; AC-C	MTR-CODE: OM 541.920	<b>KT 7004</b>
<b>3354; 3355</b>	15928 ccm	395-405 kW	OM 542.942;OM 542.962	04.03 -	ALT; AC-C	MTR-CODE: OM 541.920	<b>KT 7004</b>
<b>4140</b>	11946 ccm	290-300 kW	OM 541.923;OM 541.924;OM 541.944;OM 541.945	04.03 -	ALT; AC-C	MTR-CODE: OM 541.920	<b>KT 7004</b>
			OM 541.923;OM 541.944		ALT; AC-C	MTR-CODE: OM 541.920	<b>KT 7004</b>

### ATEGO

<b>1017</b>	4249 ccm	125 kW	OM 904.911	01.98 - 10.04	AC-C	MOD: 1017A;1017AK	<b>8 PK 2080 TM</b>
					ALT	OE-NO.: 9069933996; MOD: 1017A;1017AK;SA505031/77	<b>8 PK 1365 TM</b>
					ALT	OE-NO.: 9069934096; MOD: 1017A;1017AK;SA505031/78	<b>8 PK 1940 TM</b>
					ALT	OE-NO.: 9069970792; MOD: 1017A;1017AK;SA505031/02	<b>8 PK 1480 TM</b>
					ALT	OE-NO.: 9069970992; MOD: 1017A;1017AK;SA505031/07	<b>8 PK 2605 TM</b>
					ALT	OE-NO.: 9069971192; MOD: 1017A;1017AK;SA505031/04	<b>8 PK 2080 TM</b>
					ALT	OE-NO.: 9069971292; MOD: 1017A;1017AK;SA505031/06	<b>8 PK 2000 TM</b>
					ALT	OE-NO.: 9069972392; MOD: 1017A;1017AK;SA505031/05	<b>8 PK 2045 TM</b>
					ALT; 1. ALT	OE-NO.: 9069973092; MOD: 1017A;1017AK;SA505031/14	<b>8 PK 1230 TM</b>
					HYD-P	MOD: 1017A;1017AK	<b>8 PK 1190 TM</b>
			OM 904.911;OM 904.917		AC-C	MOD: 1017A;1017AK	<b>8 PK 2080 TM</b>
					ALT	OE-NO.: 9069933996; MOD: 1017A;1017AK;SA505031/77	<b>8 PK 1365 TM</b>
					ALT	OE-NO.: 9069934096; MOD: 1017A;1017AK;SA505031/78	<b>8 PK 1940 TM</b>
					ALT	OE-NO.: 9069970792; MOD: 1017A;1017AK;SA505031/02	<b>8 PK 1480 TM</b>
					ALT	OE-NO.: 9069970992; MOD: 1017A;1017AK;SA505031/07	<b>8 PK 2605 TM</b>
					ALT	OE-NO.: 9069971192; MOD: 1017A;1017AK;SA505031/04	<b>8 PK 2080 TM</b>
					ALT	OE-NO.: 9069971292; MOD: 1017A;1017AK;SA505031/06	<b>8 PK 2000 TM</b>
					ALT	OE-NO.: 9069972392; MOD: 1017A;1017AK;SA505031/05	<b>8 PK 2045 TM</b>
					ALT; 1. ALT	OE-NO.: 9069973092; MOD: 1017A;1017AK;SA505031/14	<b>8 PK 1230 TM</b>
					HYD-P	MOD: 1017A;1017AK	<b>8 PK 1190 TM</b>
<b>1017; 1018</b>	4249 ccm	125-130 kW	OM 900.913;OM 904.911;OM 904.917	01.98 - 10.04	AC-C	MTR-CODE: OM904.911; MOD: 1017A;1017AK	<b>8 PK 2080 TM</b>
					ALT	MTR-CODE: OM904.911; OE-NO.: 9069933996; MOD: 1017A;1017AK;SA505031/77	<b>8 PK 1365 TM</b>
					ALT	MTR-CODE: OM904.911; OE-NO.: 9069934096; MOD: 1017A;1017AK;SA505031/78	<b>8 PK 1940 TM</b>
					ALT	MTR-CODE: OM904.911; OE-NO.: 9069970792; MOD: 1017A;1017AK;SA505031/02	<b>8 PK 1480 TM</b>
					ALT	MTR-CODE: OM904.911; OE-NO.: 9069970992; MOD: 1017A;1017AK;SA505031/07	<b>8 PK 2605 TM</b>
					ALT	MTR-CODE: OM904.911; OE-NO.: 9069971192; MOD: 1017A;1017AK;SA505031/04	<b>8 PK 2080 TM</b>
					ALT	MTR-CODE: OM904.911; OE-NO.: 9069971292; MOD: 1017A;1017AK;SA505031/06	<b>8 PK 2000 TM</b>
					ALT	MTR-CODE: OM904.911; OE-NO.: 9069972392; MOD: 1017A;1017AK;SA505031/05	<b>8 PK 2045 TM</b>



## MERCEDES-BENZ

### ATEGO

#### 1017; 1018

4249 ccm	125-130 kW	OM 900.913;OM 904.911;OM 904.917	01.98 - 10.04	ALT; 1. ALT	MTR-CODE: OM904.911; OE-NO.: 9069973092; MOD: 1017A;1017AK;SA505031/14	8 PK 1230 TM
				HYD-P	MTR-CODE: OM904.911; MOD: 1017A;1017AK	8 PK 1190 TM

#### 1023

6374 ccm	170 kW	OM 906.910	01.98 - 10.04	AC-C	MOD: 1023,1023L	8 PK 2080 TM
				ALT	OE-NO.: 9069933996; MOD: 1023,1023L;SA505031/77	8 PK 1365 TM
				ALT	OE-NO.: 9069934096; MOD: 1023,1023L;SA505031/78	8 PK 1940 TM
				ALT	OE-NO.: 9069970792; MOD: 1023,1023L;SA505031/02	8 PK 1480 TM
				ALT	OE-NO.: 9069970992; MOD: 1023,1023L;SA505031/07	8 PK 2605 TM
				ALT	OE-NO.: 9069971192; MOD: 1023,1023L;SA505079/05	8 PK 2080 TM
				ALT	OE-NO.: 9069971292; MOD: 1023,1023L;SA505031/06	8 PK 2000 TM
				ALT	OE-NO.: 9069972392; MOD: 1023,1023L;SA505031/05	8 PK 2045 TM
				ALT	OE-NO.: 9069972492; MOD: 1023,1023L;SA505031/03	8 PK 1420 TM
				ALT	OE-NO.: 9069973592; MOD: 1023,1023L;SA505031/21	8 PK 1940 TM
				ALT	OE-NO.: 9069973692; MOD: 1023,1023L;SA505031/22	8 PK 2560 TM
				FAN	OE-NO.: 9069932896; MOD: 1023,1023L;SA505031/56	10 PK 1240 TM
				HYD-P	OE-NO.: 9069934496; MOD: 1023,1023L;SA505031/96	8 PK 1175 TM
				HYD-P	OE-NO.: 9069934596; MOD: 1023,1023L;SA505031/25	8 PK 1190 TM
				HYD-P	OE-NO.: 9069934596; MOD: 1023,1023L;SA505065/03	8 PK 1190 TM

#### 1215

4249 ccm	112 kW	OM 904.922	01.98 - 10.04	AC-C	MOD: 1215K;1215,1215L	8 PK 2080 TM
				ALT	OE-NO.: 9069933996; MOD: 1215K;1215,1215L;SA505031/77	8 PK 1365 TM
				ALT	OE-NO.: 9069934096; MOD: 1215K;1215,1215L;SA505031/78	8 PK 1940 TM
				ALT	OE-NO.: 9069970792; MOD: 1215K;1215,1215L;SA505031/02	8 PK 1480 TM
				ALT	OE-NO.: 9069970992; MOD: 1215K;1215,1215L;SA505031/07	8 PK 2605 TM
				ALT	OE-NO.: 9069971192; MOD: 1215K;1215,1215L;SA505031/04	8 PK 2080 TM
				ALT	OE-NO.: 9069971292; MOD: 1215K;1215,1215L;SA505031/06	8 PK 2000 TM
				ALT	OE-NO.: 9069972392; MOD: 1215K;1215,1215L;SA505031/05	8 PK 2045 TM
				ALT; 1. ALT	OE-NO.: 9069973092; MOD: 1215K;1215,1215L;SA505031/14	8 PK 1230 TM
				HYD-P	OE-NO.: 9069971492; MOD: 1215K;1215,1215L	8 PK 1175 TM

#### 1217

4249 ccm	125 kW	OM 904.911	01.98 - 10.04	AC-C	MOD: 1217K;1217KO	8 PK 2080 TM
				ALT	OE-NO.: 9069933996; MOD: 1217K;1217KO;SA505031/77	8 PK 1365 TM
				ALT	OE-NO.: 9069934096; MOD: 1217K;1217KO;SA505031/78	8 PK 1940 TM
				ALT	OE-NO.: 9069970792; MOD: 1217K;1217KO;SA505031/02	8 PK 1480 TM
				ALT	OE-NO.: 9069970992; MOD: 1217K;1217KO;SA505031/07	8 PK 2605 TM
				ALT	OE-NO.: 9069971192; MOD: 1217K;1217KO;SA505031/04	8 PK 2080 TM
				ALT	OE-NO.: 9069971292; MOD: 1217K;1217KO;SA505031/06	8 PK 2000 TM
				ALT	OE-NO.: 9069972392; MOD: 1217K;1217KO;SA505031/05	8 PK 2045 TM
				ALT; 1. ALT	OE-NO.: 9069973092; MOD: 1217K;1217KO;SA505031/14	8 PK 1230 TM
				HYD-P	MOD: 1217K;1217KO	8 PK 1190 TM
		OM 904.911;OM 904.917		AC-C	MOD: 1217K;1217KO	8 PK 2080 TM

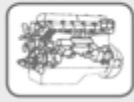

## MERCEDES-BENZ

### ATEGO

#### 1217

4249 ccm	125 kW	OM 904.911;OM 904.917	01.98 - 10.04	ALT	OE-NO.: 9069933996; MOD: 1217K;1217KO;SA505031/77	8 PK 1365 TM
				ALT	OE-NO.: 9069934096; MOD: 1217K;1217KO;SA505031/78	8 PK 1940 TM
				ALT	OE-NO.: 9069970792; MOD: 1217K;1217KO;SA505031/02	8 PK 1480 TM
				ALT	OE-NO.: 9069970992; MOD: 1217K;1217KO;SA505031/07	8 PK 2605 TM
				ALT	OE-NO.: 9069971192; MOD: 1217K;1217KO;SA505031/04	8 PK 2080 TM
				ALT	OE-NO.: 9069971292; MOD: 1217K;1217KO;SA505031/06	8 PK 2000 TM
				ALT	OE-NO.: 9069972392; MOD: 1217K;1217KO;SA505031/05	8 PK 2045 TM
				ALT; 1. ALT	OE-NO.: 9069973092; MOD: 1217K;1217KO;SA505031/14	8 PK 1230 TM
				HYD-P	MOD: 1217K;1217KO	8 PK 1190 TM

#### 1223

6374 ccm	170 kW	OM 906.910;OM 906.915	01.98 - 10.04	AC-C	MOD: 1223,1223L	8 PK 2080 TM
				ALT	OE-NO.: 9069933996; MOD: 1223,1223L;SA505031/77	8 PK 1365 TM
				ALT	OE-NO.: 9069934096; MOD: 1223,1223L;SA505031/78	8 PK 1940 TM
				ALT	OE-NO.: 9069970792; MOD: 1223,1223L;SA505031/02	8 PK 1480 TM
				ALT	OE-NO.: 9069970992; MOD: 1223,1223L;SA505031/07	8 PK 2605 TM
				ALT	OE-NO.: 9069971192; MOD: 1223,1223L;SA505079/05	8 PK 2080 TM
				ALT	OE-NO.: 9069971292; MOD: 1223,1223L;SA505031/06	8 PK 2000 TM
				ALT	OE-NO.: 9069972392; MOD: 1223,1223L;SA505031/05	8 PK 2045 TM
				ALT	OE-NO.: 9069972492; MOD: 1223,1223L;SA505031/03	8 PK 1420 TM
				ALT	OE-NO.: 9069973592; MOD: 1223,1223L;SA505031/21	8 PK 1940 TM
				ALT	OE-NO.: 9069973692; MOD: 1223,1223L;SA505031/22	8 PK 2560 TM
				FAN	OE-NO.: 9069932896; MOD: 1223,1223L;SA505031/56	10 PK 1240 TM
				HYD-P	OE-NO.: 9069934496; MOD: 1223,1223L;SA505031/96	8 PK 1175 TM
				HYD-P	OE-NO.: 9069934596; MOD: 1223,1223L;SA505031/25	8 PK 1190 TM
				HYD-P	OE-NO.: 9069934596; MOD: 1223,1223L;SA505065/03	8 PK 1190 TM

#### 1225

6374 ccm	180 kW	OM 906.919;OM 906.939	01.98 - 10.04	AC-C	OE-NO.: 9069971192; MOD: 1225AF;1225F;SA505079/05	8 PK 2080 TM
				ALT	OE-NO.: 9069933996; MOD: 1225AF;1225F;SA505031/77	8 PK 1365 TM
				ALT	OE-NO.: 9069934096; MOD: 1225AF;1225F;SA505031/78	8 PK 1940 TM
				ALT	OE-NO.: 9069970792; MOD: 1225AF;1225F;SA505031/02	8 PK 1480 TM
				ALT	OE-NO.: 9069970992; MOD: 1225AF;1225F;SA505031/07	8 PK 2605 TM
				ALT	OE-NO.: 9069971192; MOD: 1225AF;1225F;SA505031/04	8 PK 2080 TM
				ALT	OE-NO.: 9069971292; MOD: 1225AF;1225F;SA505031/06	8 PK 2000 TM
				ALT	OE-NO.: 9069972392; MOD: 1225AF;1225F;SA505031/05	8 PK 2045 TM
				ALT	OE-NO.: 9069972492; MOD: 1225AF;1225F;SA505031/03	8 PK 1420 TM
				ALT	OE-NO.: 9069973592; MOD: 1225AF;1225F;SA505031/21	8 PK 1940 TM
				ALT	OE-NO.: 9069973692; MOD: 1225AF;1225F;SA505031/22	8 PK 2560 TM
				FAN	OE-NO.: 9069932896; MOD: 1225AF;1225F;SA505031/56	10 PK 1240 TM
				FAN	OE-NO.: 9069973392; MOD: 1225AF;1225F;SA505031/16	10 PK 1240 TM



## MERCEDES-BENZ

### ATEGO

#### 1225

6374 ccm	180 kW	OM 906.919;OM 906.939	01.98 - 10.04	HYD-P	OE-NO.: 9069934496; MOD: 1225AF;1225F;SA505031/96	8 PK 1175 TM
				HYD-P	OE-NO.: 9069971392; MOD: 1225AF;1225F;SA505031/25	8 PK 1190 TM
				HYD-P	OE-NO.: 9069971392; MOD: 1225AF;1225F;SA505065/03	8 PK 1190 TM

#### 1228

6374 ccm	205 kW	OM 906.911;OM 906.916	01.98 - 10.04	AC-C	OE-NO.: 9069971192; MOD: 1228,1228L;SA505079/05	8 PK 2080 TM
				ALT	OE-NO.: 9069933996; MOD: 1228,1228L;SA505031/77	8 PK 1365 TM
				ALT	OE-NO.: 9069934096; MOD: 1228,1228L;SA505031/78	8 PK 1940 TM
				ALT	OE-NO.: 9069970792; MOD: 1228,1228L;SA505031/02	8 PK 1480 TM
				ALT	OE-NO.: 9069970992; MOD: 1228,1228L;SA505031/07	8 PK 2605 TM
				ALT	OE-NO.: 9069971192; MOD: 1228,1228L;SA505031/04	8 PK 2080 TM
				ALT	OE-NO.: 9069971292; MOD: 1228,1228L;SA505031/06	8 PK 2000 TM
				ALT	OE-NO.: 9069972392; MOD: 1228,1228L;SA505031/05	8 PK 2045 TM
				ALT	OE-NO.: 9069972492; MOD: 1228,1228L;SA505031/03	8 PK 1420 TM
				ALT	OE-NO.: 9069973592; MOD: 1228,1228L;SA505031/21	8 PK 1940 TM
				ALT	OE-NO.: 9069973692; MOD: 1228,1228L;SA505031/22	8 PK 2560 TM
				FAN	OE-NO.: 9069932896; MOD: 1228,1228L;SA505031/56	10 PK 1240 TM
				FAN	OE-NO.: 9069973392; MOD: 1228,1228L;SA505031/16	10 PK 1240 TM
				HYD-P	OE-NO.: 9069934496; MOD: 1228,1228L;SA505031/96	8 PK 1175 TM
				HYD-P	OE-NO.: 9069971392; MOD: 1228,1228L;SA505031/25	8 PK 1190 TM
				HYD-P	OE-NO.: 9069971392; MOD: 1228,1228L;SA505065/03	8 PK 1190 TM

#### 1317

4249 ccm	125-130 kW	OM 900.913;OM 904.911;OM 904.917	01.98 - 10.04	AC-C	MOD: 1317A;1317AK	8 PK 2080 TM
				ALT	OE-NO.: 9069933996; MOD: 1317A;1317AK;SA505031/77	8 PK 1365 TM
				ALT	OE-NO.: 9069934096; MOD: 1317A;1317AK;SA505031/78	8 PK 1940 TM
				ALT	OE-NO.: 9069970792; MOD: 1317A;1317AK;SA505031/02	8 PK 1480 TM
				ALT	OE-NO.: 9069970992; MOD: 1317A;1317AK;SA505031/07	8 PK 2605 TM
				ALT	OE-NO.: 9069971192; MOD: 1317A;1317AK;SA505031/04	8 PK 2080 TM
				ALT	OE-NO.: 9069971292; MOD: 1317A;1317AK;SA505031/06	8 PK 2000 TM
				ALT	OE-NO.: 9069972392; MOD: 1317A;1317AK;SA505031/05	8 PK 2045 TM
				ALT; 1. ALT	OE-NO.: 9069973092; MOD: 1317A;1317AK;SA505031/14	8 PK 1230 TM
				HYD-P	MOD: 1317A;1317AK	8 PK 1190 TM
				AC-C	MOD: 1317A;1317AK	8 PK 2080 TM
				ALT	OE-NO.: 9069933996; MOD: 1317A;1317AK;SA505031/77	8 PK 1365 TM
				ALT	OE-NO.: 9069934096; MOD: 1317A;1317AK;SA505031/78	8 PK 1940 TM
				ALT	OE-NO.: 9069970792; MOD: 1317A;1317AK;SA505031/02	8 PK 1480 TM
				ALT	OE-NO.: 9069970992; MOD: 1317A;1317AK;SA505031/07	8 PK 2605 TM
				ALT	OE-NO.: 9069971192; MOD: 1317A;1317AK;SA505031/04	8 PK 2080 TM
				ALT	OE-NO.: 9069971292; MOD: 1317A;1317AK;SA505031/06	8 PK 2000 TM
				ALT	OE-NO.: 9069972392; MOD: 1317A;1317AK;SA505031/05	8 PK 2045 TM

125 kW OM 904.911;OM 904.917



## MERCEDES-BENZ

### ATEGO

#### 1317

4249 ccm	125 kW	OM 904.911;OM 904.917	01.98 - 10.04	ALT; 1. ALT	OE-NO.: 9069973092; MOD: 1317A;1317AK;SA505031/14	8 PK 1230 TM
				HYD-P	MOD: 1317A;1317AK	8 PK 1190 TM

#### 1317; 1318

4249 ccm	125-130 kW	OM 900.913;OM 904.911;OM 904.917	01.98 - 10.04	AC-C	MTR-CODE: OM904.911; MOD: 1317A;1317AK	8 PK 2080 TM
				ALT	MTR-CODE: OM904.911; OE-NO.: 9069933996; MOD: 1317A;1317AK;SA505031/77	8 PK 1365 TM
				ALT	MTR-CODE: OM904.911; OE-NO.: 9069934096; MOD: 1317A;1317AK;SA505031/78	8 PK 1940 TM
				ALT	MTR-CODE: OM904.911; OE-NO.: 9069970792; MOD: 1317A;1317AK;SA505031/02	8 PK 1480 TM
				ALT	MTR-CODE: OM904.911; OE-NO.: 9069970992; MOD: 1317A;1317AK;SA505031/07	8 PK 2605 TM
				ALT	MTR-CODE: OM904.911; OE-NO.: 9069971192; MOD: 1317A;1317AK;SA505031/04	8 PK 2080 TM
				ALT	MTR-CODE: OM904.911; OE-NO.: 9069971292; MOD: 1317A;1317AK;SA505031/06	8 PK 2000 TM
				ALT	MTR-CODE: OM904.911; OE-NO.: 9069972392; MOD: 1317A;1317AK;SA505031/05	8 PK 2045 TM
				ALT; 1. ALT	MTR-CODE: OM904.911; OE-NO.: 9069973092; MOD: 1317A;1317AK;SA505031/14	8 PK 1230 TM
				HYD-P	MTR-CODE: OM904.911; MOD: 1317A;1317AK	8 PK 1190 TM

#### 1323

6374 ccm	170 kW	OM 906.910	01.98 - 10.04	AC-C	MOD: 1323KO;1323LS	8 PK 2080 TM
				ALT	OE-NO.: 9069933996; MOD: 1323KO;1323LS;SA505031/77	8 PK 1365 TM
				ALT	OE-NO.: 9069934096; MOD: 1323KO;1323LS;SA505031/78	8 PK 1940 TM
				ALT	OE-NO.: 9069970792; MOD: 1323KO;1323LS;SA505031/02	8 PK 1480 TM
				ALT	OE-NO.: 9069970992; MOD: 1323KO;1323LS;SA505031/07	8 PK 2605 TM
				ALT	OE-NO.: 9069971192; MOD: 1323KO;1323LS;SA505079/05	8 PK 2080 TM
				ALT	OE-NO.: 9069971292; MOD: 1323KO;1323LS;SA505031/06	8 PK 2000 TM
				ALT	OE-NO.: 9069972392; MOD: 1323KO;1323LS;SA505031/05	8 PK 2045 TM
				ALT	OE-NO.: 9069972492; MOD: 1323KO;1323LS;SA505031/03	8 PK 1420 TM
				ALT	OE-NO.: 9069973592; MOD: 1323KO;1323LS;SA505031/21	8 PK 1940 TM
				ALT	OE-NO.: 9069973692; MOD: 1323KO;1323LS;SA505031/22	8 PK 2560 TM
				FAN	OE-NO.: 9069932896; MOD: 1323KO;1323LS;SA505031/56	10 PK 1240 TM
				HYD-P	OE-NO.: 9069934496; MOD: 1323KO;1323LS;SA505031/96	8 PK 1175 TM
				HYD-P	OE-NO.: 9069934596; MOD: 1323KO;1323LS;SA505031/25	8 PK 1190 TM
				HYD-P	OE-NO.: 9069934596; MOD: 1323KO;1323LS;SA505065/03	8 PK 1190 TM
		OM 906.910;OM 906.915		AC-C	MOD: 1323KO;1323LS	8 PK 2080 TM
				ALT	OE-NO.: 9069933996; MOD: 1323KO;1323LS;SA505031/77	8 PK 1365 TM
				ALT	OE-NO.: 9069934096; MOD: 1323KO;1323LS;SA505031/78	8 PK 1940 TM
				ALT	OE-NO.: 9069970792; MOD: 1323KO;1323LS;SA505031/02	8 PK 1480 TM
				ALT	OE-NO.: 9069970992; MOD: 1323KO;1323LS;SA505031/07	8 PK 2605 TM
				ALT	OE-NO.: 9069971192; MOD: 1323KO;1323LS;SA505079/05	8 PK 2080 TM
				ALT	OE-NO.: 9069971292; MOD: 1323KO;1323LS;SA505031/06	8 PK 2000 TM
				ALT	OE-NO.: 9069972392; MOD: 1323KO;1323LS;SA505031/05	8 PK 2045 TM
				ALT	OE-NO.: 9069972492; MOD: 1323KO;1323LS;SA505031/03	8 PK 1420 TM
				ALT	OE-NO.: 9069973592; MOD: 1323KO;1323LS;SA505031/21	8 PK 1940 TM



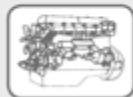

## MERCEDES-BENZ

### ATEGO

#### 1323

6374 ccm	170 kW	OM 906.910;OM 906.915	01.98 - 10.04	ALT	OE-NO.: 9069973692; MOD: 1323KO;1323LS;SA505031/22	8 PK 2560 TM
				FAN	OE-NO.: 9069932896; MOD: 1323KO;1323LS;SA505031/56	10 PK 1240 TM
				HYD-P	OE-NO.: 9069934496; MOD: 1323KO;1323LS;SA505031/96	8 PK 1175 TM
				HYD-P	OE-NO.: 9069934596; MOD: 1323KO;1323LS;SA505031/25	8 PK 1190 TM
				HYD-P	OE-NO.: 9069934596; MOD: 1323KO;1323LS;SA505065/03	8 PK 1190 TM

#### 1325

6374 ccm	180 kW	OM 906.919;OM 906.939	01.98 - 10.04	AC-C	OE-NO.: 9069971192; MOD: 1325AF;1325F;SA505079/05	8 PK 2080 TM
				ALT	OE-NO.: 9069933996; MOD: 1325AF;1325F;SA505031/77	8 PK 1365 TM
				ALT	OE-NO.: 9069934096; MOD: 1325AF;1325F;SA505031/78	8 PK 1940 TM
				ALT	OE-NO.: 9069970792; MOD: 1325AF;1325F;SA505031/02	8 PK 1480 TM
				ALT	OE-NO.: 9069970992; MOD: 1325AF;1325F;SA505031/07	8 PK 2605 TM
				ALT	OE-NO.: 9069971192; MOD: 1325AF;1325F;SA505031/04	8 PK 2080 TM
				ALT	OE-NO.: 9069971292; MOD: 1325AF;1325F;SA505031/06	8 PK 2000 TM
				ALT	OE-NO.: 9069972392; MOD: 1325AF;1325F;SA505031/05	8 PK 2045 TM
				ALT	OE-NO.: 9069972492; MOD: 1325AF;1325F;SA505031/03	8 PK 1420 TM
				ALT	OE-NO.: 9069973592; MOD: 1325AF;1325F;SA505031/21	8 PK 1940 TM
				ALT	OE-NO.: 9069973692; MOD: 1325AF;1325F;SA505031/22	8 PK 2560 TM
				FAN	OE-NO.: 9069932896; MOD: 1325AF;1325F;SA505031/56	10 PK 1240 TM
				FAN	OE-NO.: 9069973392; MOD: 1325AF;1325F;SA505031/16	10 PK 1240 TM
				HYD-P	OE-NO.: 9069934496; MOD: 1325AF;1325F;SA505031/96	8 PK 1175 TM
				HYD-P	OE-NO.: 9069971392; MOD: 1325AF;1325F;SA505031/25	8 PK 1190 TM
				HYD-P	OE-NO.: 9069971392; MOD: 1325AF;1325F;SA505065/03	8 PK 1190 TM

#### 1328

6374 ccm	205 kW	OM 906.911	01.98 - 10.04	AC-C	OE-NO.: 9069971192; MOD: 1328AF;1328F;SA505079/05	8 PK 2080 TM
				ALT	OE-NO.: 9069933996; MOD: 1328AF;1328F;SA505031/77	8 PK 1365 TM
				ALT	OE-NO.: 9069934096; MOD: 1328AF;1328F;SA505031/78	8 PK 1940 TM
				ALT	OE-NO.: 9069970792; MOD: 1328AF;1328F;SA505031/02	8 PK 1480 TM
				ALT	OE-NO.: 9069970992; MOD: 1328AF;1328F;SA505031/07	8 PK 2605 TM
				ALT	OE-NO.: 9069971192; MOD: 1328AF;1328F;SA505031/04	8 PK 2080 TM
				ALT	OE-NO.: 9069971292; MOD: 1328AF;1328F;SA505031/06	8 PK 2000 TM
				ALT	OE-NO.: 9069972392; MOD: 1328AF;1328F;SA505031/05	8 PK 2045 TM
				ALT	OE-NO.: 9069972492; MOD: 1328AF;1328F;SA505031/03	8 PK 1420 TM
				ALT	OE-NO.: 9069973592; MOD: 1328AF;1328F;SA505031/21	8 PK 1940 TM
				ALT	OE-NO.: 9069973692; MOD: 1328AF;1328F;SA505031/22	8 PK 2560 TM
				FAN	OE-NO.: 9069932896; MOD: 1328AF;1328F;SA505031/56	10 PK 1240 TM
				FAN	OE-NO.: 9069973392; MOD: 1328AF;1328F;SA505031/16	10 PK 1240 TM
				HYD-P	OE-NO.: 9069934496; MOD: 1328AF;1328F;SA505031/96	8 PK 1175 TM
				HYD-P	OE-NO.: 9069971392; MOD: 1328AF;1328F;SA505031/25	8 PK 1190 TM



## MERCEDES-BENZ

### ATEGO

#### 1328

6374 ccm	205 kW	OM 906.911	01.98 - 10.04	HYD-P	OE-NO.: 9069971392; MOD: 1328AF;1328F;SA505065/03	8 PK 1190 TM
		OM 906.911;OM 906.916		AC-C	OE-NO.: 9069971192; MOD: 1328AF;1328F;SA505079/05	8 PK 2080 TM
				ALT	OE-NO.: 9069933996; MOD: 1328AF;1328F;SA505031/77	8 PK 1365 TM
				ALT	OE-NO.: 9069934096; MOD: 1328AF;1328F;SA505031/78	8 PK 1940 TM
				ALT	OE-NO.: 9069970792; MOD: 1328AF;1328F;SA505031/02	8 PK 1480 TM
				ALT	OE-NO.: 9069970992; MOD: 1328AF;1328F;SA505031/07	8 PK 2605 TM
				ALT	OE-NO.: 9069971192; MOD: 1328AF;1328F;SA505031/04	8 PK 2080 TM
				ALT	OE-NO.: 9069971292; MOD: 1328AF;1328F;SA505031/06	8 PK 2000 TM
				ALT	OE-NO.: 9069972392; MOD: 1328AF;1328F;SA505031/05	8 PK 2045 TM
				ALT	OE-NO.: 9069972492; MOD: 1328AF;1328F;SA505031/03	8 PK 1420 TM
				ALT	OE-NO.: 9069973592; MOD: 1328AF;1328F;SA505031/21	8 PK 1940 TM
				ALT	OE-NO.: 9069973692; MOD: 1328AF;1328F;SA505031/22	8 PK 2560 TM
				FAN	OE-NO.: 9069932896; MOD: 1328AF;1328F;SA505031/56	10 PK 1240 TM
				FAN	OE-NO.: 9069973392; MOD: 1328AF;1328F;SA505031/16	10 PK 1240 TM
				HYD-P	OE-NO.: 9069934496; MOD: 1328AF;1328F;SA505031/96	8 PK 1175 TM
				HYD-P	OE-NO.: 9069971392; MOD: 1328AF;1328F;SA505031/25	8 PK 1190 TM
				HYD-P	OE-NO.: 9069971392; MOD: 1328AF;1328F;SA505065/03	8 PK 1190 TM

#### 1517

4249 ccm	125 kW	OM 904.911	01.98 - 10.04	AC-C	MOD: 1517A;1517K	8 PK 2080 TM
				AC-C	OE-NO.: 9069971192; MOD: 1517A;1517K;SA505031/04	8 PK 2080 TM
				ALT	OE-NO.: 9069933996; MOD: 1517A;1517K;SA505031/77	8 PK 1365 TM
				ALT	OE-NO.: 9069934096; MOD: 1517A;1517K;SA505031/78	8 PK 1940 TM
				ALT	OE-NO.: 9069970792; MOD: 1517A;1517K;SA505031/02	8 PK 1480 TM
				ALT	OE-NO.: 9069970992; MOD: 1517A;1517K;SA505031/07	8 PK 2605 TM
				ALT	OE-NO.: 9069971292; MOD: 1517A;1517K;SA505031/06	8 PK 2000 TM
				ALT	OE-NO.: 9069972392; MOD: 1517A;1517K;SA505031/05	8 PK 2045 TM
				ALT; 1. ALT	OE-NO.: 9069973092; MOD: 1517A;1517K;SA505031/14	8 PK 1230 TM
				HYD-P	MOD: 1517A;1517K	8 PK 1190 TM
		OM 904.911;OM 904.917		AC-C	MOD: 1517A;1517K	8 PK 2080 TM
				ALT	OE-NO.: 9069933996; MOD: 1517A;1517K;SA505031/77	8 PK 1365 TM
				ALT	OE-NO.: 9069934096; MOD: 1517A;1517K;SA505031/78	8 PK 1940 TM
				ALT	OE-NO.: 9069970792; MOD: 1517A;1517K;SA505031/02	8 PK 1480 TM
				ALT	OE-NO.: 9069970992; MOD: 1517A;1517K;SA505031/07	8 PK 2605 TM
				ALT	OE-NO.: 9069971192; MOD: 1517A;1517K;SA505031/04	8 PK 2080 TM
				ALT	OE-NO.: 9069971292; MOD: 1517A;1517K;SA505031/06	8 PK 2000 TM
				ALT	OE-NO.: 9069972392; MOD: 1517A;1517K;SA505031/05	8 PK 2045 TM
				ALT; 1. ALT	OE-NO.: 9069973092; MOD: 1517A;1517K;SA505031/14	8 PK 1230 TM
				HYD-P	MOD: 1517A;1517K	8 PK 1190 TM

#### 1523

6374 ccm	170 kW	OM 906.910;OM 906.915	01.98 - 10.04	AC-C	MOD: 1523A;1523AK	8 PK 2080 TM
----------	--------	-----------------------	---------------	------	-------------------	--------------



## MERCEDES-BENZ

### ATEGO

#### 1523

6374 ccm	170 kW	OM 906.910;OM 906.915	01.98 - 10.04	AC-C	OE-NO.: 9069971192; MOD: 1523A;1523AK;SA505079/05	8 PK 2080 TM
				ALT	OE-NO.: 9069933996; MOD: 1523A;1523AK;SA505031/77	8 PK 1365 TM
				ALT	OE-NO.: 9069934096; MOD: 1523A;1523AK;SA505031/78	8 PK 1940 TM
				ALT	OE-NO.: 9069970792; MOD: 1523A;1523AK;SA505031/02	8 PK 1480 TM
				ALT	OE-NO.: 9069970992; MOD: 1523A;1523AK;SA505031/07	8 PK 2605 TM
				ALT	OE-NO.: 9069971292; MOD: 1523A;1523AK;SA505031/06	8 PK 2000 TM
				ALT	OE-NO.: 9069972392; MOD: 1523A;1523AK;SA505031/05	8 PK 2045 TM
				ALT	OE-NO.: 9069972492; MOD: 1523A;1523AK;SA505031/03	8 PK 1420 TM
				ALT	OE-NO.: 9069973592; MOD: 1523A;1523AK;SA505031/21	8 PK 1940 TM
				ALT	OE-NO.: 9069973692; MOD: 1523A;1523AK;SA505031/22	8 PK 2560 TM
				FAN	OE-NO.: 9069932896; MOD: 1523A;1523AK;SA505031/56	10 PK 1240 TM
				HYD-P	OE-NO.: 9069934496; MOD: 1523A;1523AK;SA505031/96	8 PK 1175 TM
				HYD-P	OE-NO.: 9069934596; MOD: 1523A;1523AK;SA505031/25	8 PK 1190 TM
				HYD-P	OE-NO.: 9069934596; MOD: 1523A;1523AK;SA505065/03	8 PK 1190 TM

#### 1525

6374 ccm	180 kW	OM 906.919;OM 906.939	01.98 - 10.04	AC-C	OE-NO.: 9069971192; MOD: 1525AF;SA505031/04	8 PK 2080 TM
				AC-C	OE-NO.: 9069971192; MOD: 1525AF;SA505079/05	8 PK 2080 TM
				ALT	OE-NO.: 9069933996; MOD: 1525AF;SA505031/77	8 PK 1365 TM
				ALT	OE-NO.: 9069934096; MOD: 1525AF;SA505031/78	8 PK 1940 TM
				ALT	OE-NO.: 9069970792; MOD: 1525AF;SA505031/02	8 PK 1480 TM
				ALT	OE-NO.: 9069970992; MOD: 1525AF;SA505031/07	8 PK 2605 TM
				ALT	OE-NO.: 9069971292; MOD: 1525AF;SA505031/06	8 PK 2000 TM
				ALT	OE-NO.: 9069972392; MOD: 1525AF;SA505031/05	8 PK 2045 TM
				ALT	OE-NO.: 9069972492; MOD: 1525AF;SA505031/03	8 PK 1420 TM
				ALT	OE-NO.: 9069973592; MOD: 1525AF;SA505031/21	8 PK 1940 TM
				ALT	OE-NO.: 9069973692; MOD: 1525AF;SA505031/22	8 PK 2560 TM
				FAN	OE-NO.: 9069932896; MOD: 1525AF;SA505031/56	10 PK 1240 TM
				FAN	OE-NO.: 9069973392; MOD: 1525AF;SA505031/16	10 PK 1240 TM
				HYD-P	OE-NO.: 9069934496; MOD: 1525AF;SA505031/96	8 PK 1175 TM
				HYD-P	OE-NO.: 9069971392; MOD: 1525AF;SA505031/25	8 PK 1190 TM
				HYD-P	OE-NO.: 9069971392; MOD: 1525AF;SA505065/03	8 PK 1190 TM

#### 1528

6374 ccm	205 kW	OM 906.911;OM 906.916	01.98 - 10.04	AC-C	OE-NO.: 9069971192; MOD: 1528AF;1528F;SA505031/04	8 PK 2080 TM
				AC-C	OE-NO.: 9069971192; MOD: 1528AF;1528F;SA505079/05	8 PK 2080 TM
				ALT	OE-NO.: 9069933996; MOD: 1528AF;1528F;SA505031/77	8 PK 1365 TM
				ALT	OE-NO.: 9069934096; MOD: 1528AF;1528F;SA505031/78	8 PK 1940 TM
				ALT	OE-NO.: 9069970792; MOD: 1528AF;1528F;SA505031/02	8 PK 1480 TM
				ALT	OE-NO.: 9069970992; MOD: 1528AF;1528F;SA505031/07	8 PK 2605 TM

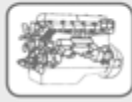

## MERCEDES-BENZ

### ATEGO

#### 1528

6374 ccm	205 kW	OM 906.911;OM 906.916	01.98 - 10.04	ALT	OE-NO.: 9069971292; MOD: 1528AF;1528F;SA505031/06	8 PK 2000 TM
				ALT	OE-NO.: 9069972392; MOD: 1528AF;1528F;SA505031/05	8 PK 2045 TM
				ALT	OE-NO.: 9069972492; MOD: 1528AF;1528F;SA505031/03	8 PK 1420 TM
				ALT	OE-NO.: 9069973592; MOD: 1528AF;1528F;SA505031/21	8 PK 1940 TM
				ALT	OE-NO.: 9069973692; MOD: 1528AF;1528F;SA505031/22	8 PK 2560 TM
				FAN	OE-NO.: 9069932896; MOD: 1528AF;1528F;SA505031/56	10 PK 1240 TM
				FAN	OE-NO.: 9069973392; MOD: 1528AF;1528F;SA505031/16	10 PK 1240 TM
				HYD-P	OE-NO.: 9069934496; MOD: 1528AF;1528F;SA505031/96	8 PK 1175 TM
				HYD-P	OE-NO.: 9069971392; MOD: 1528AF;1528F;SA505031/25	8 PK 1190 TM
				HYD-P	OE-NO.: 9069971392; MOD: 1528AF;1528F;SA505065/03	8 PK 1190 TM

#### 1823

6374 ccm	170 kW	OM 906.920	01.98 - 10.04	AC-C	OE-NO.: 9069971192; MOD: 1823AK;1823K;SA505031/04	8 PK 2080 TM
				AC-C	OE-NO.: 9069971192; MOD: 1823AK;1823K;SA505079/05	8 PK 2080 TM
				ALT	OE-NO.: 9069933996; MOD: 1823AK;1823K;SA505031/77	8 PK 1365 TM
				ALT	OE-NO.: 9069970792; MOD: 1823AK;1823K;SA505031/02	8 PK 1480 TM
				ALT	OE-NO.: 9069970992; MOD: 1823AK;1823K;SA505031/07	8 PK 2605 TM
				ALT	OE-NO.: 9069971292; MOD: 1823AK;1823K;SA505031/06	8 PK 2000 TM
				ALT	OE-NO.: 9069972392; MOD: 1823AK;1823K;SA505031/05	8 PK 2045 TM
				ALT	OE-NO.: 9069972492; MOD: 1823AK;1823K;SA505031/03	8 PK 1420 TM
				ALT	OE-NO.: 9069973592; MOD: 1823AK;1823K;SA505031/21/78	8 PK 1940 TM
				ALT	OE-NO.: 9069973692; MOD: 1823AK;1823K;SA505031/22	8 PK 2560 TM
				FAN	OE-NO.: 9069973392; MOD: 1823AK;1823K;SA505031/16/56	10 PK 1240 TM
				HYD-P	OE-NO.: 9069934496; MOD: 1823AK;1823K;SA505031/96	8 PK 1175 TM
				HYD-P	OE-NO.: 9069971392; MOD: 1823AK;1823K;SA505031/25	8 PK 1190 TM
				HYD-P	OE-NO.: 9069971392; MOD: 1823AK;1823K;SA505065/03	8 PK 1190 TM
		OM 906.920;OM 906.925		AC-C	MTR-CODE: OM906.920; OE-NO.: 9069971192; MOD: 1823AK;1823K;SA505031/04	8 PK 2080 TM
				AC-C	MTR-CODE: OM906.920; OE-NO.: 9069971192; MOD: 1823AK;1823K;SA505079/05	8 PK 2080 TM
				ALT	MTR-CODE: OM906.920; OE-NO.: 9069933996; MOD: 1823AK;1823K;SA505031/77	8 PK 1365 TM
				ALT	MTR-CODE: OM906.920; OE-NO.: 9069970792; MOD: 1823AK;1823K;SA505031/02	8 PK 1480 TM
				ALT	MTR-CODE: OM906.920; OE-NO.: 9069970992; MOD: 1823AK;1823K;SA505031/07	8 PK 2605 TM
				ALT	MTR-CODE: OM906.920; OE-NO.: 9069971292; MOD: 1823AK;1823K;SA505031/06	8 PK 2000 TM
				ALT	MTR-CODE: OM906.920; OE-NO.: 9069972392; MOD: 1823AK;1823K;SA505031/05	8 PK 2045 TM
				ALT	MTR-CODE: OM906.920; OE-NO.: 9069972492; MOD: 1823AK;1823K;SA505031/03	8 PK 1420 TM
				ALT	MTR-CODE: OM906.920; OE-NO.: 9069973592; MOD: 1823AK;1823K;SA505031/21/78	8 PK 1940 TM
				ALT	MTR-CODE: OM906.920; OE-NO.: 9069973692; MOD: 1823AK;1823K;SA505031/22	8 PK 2560 TM
				FAN	MTR-CODE: OM906.920; OE-NO.: 9069973392; MOD: 1823AK;1823K;SA505031/16/56	10 PK 1240 TM
				HYD-P	MTR-CODE: OM906.920; OE-NO.: 9069934496; MOD: 1823AK;1823K;SA505031/96	8 PK 1175 TM

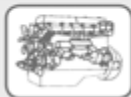

## MERCEDES-BENZ

### ATEGO

#### 1823

6374 ccm	170 kW	OM 906.920;OM 906.925	01.98 - 10.04	HYD-P	MTR-CODE: OM906.920; OE-NO.: 9069971392; MOD: 1823AK;1823K;SA505031/25	8 PK 1190 TM
				HYD-P	MTR-CODE: OM906.920; OE-NO.: 9069971392; MOD: 1823AK;1823K;SA505065/03	8 PK 1190 TM
		OM 906.922		AC-C	MTR-CODE: OM906.920; OE-NO.: 9069971192; MOD: 1823AK;1823K;SA505031/04	8 PK 2080 TM
				AC-C	MTR-CODE: OM906.920; OE-NO.: 9069971192; MOD: 1823AK;1823K;SA505079/05	8 PK 2080 TM
				ALT	MTR-CODE: OM906.920; OE-NO.: 9069933996; MOD: 1823AK;1823K;SA505031/77	8 PK 1365 TM
				ALT	MTR-CODE: OM906.920; OE-NO.: 9069970792; MOD: 1823AK;1823K;SA505031/02	8 PK 1480 TM
				ALT	MTR-CODE: OM906.920; OE-NO.: 9069970992; MOD: 1823AK;1823K;SA505031/07	8 PK 2605 TM
				ALT	MTR-CODE: OM906.920; OE-NO.: 9069971292; MOD: 1823AK;1823K;SA505031/06	8 PK 2000 TM
				ALT	MTR-CODE: OM906.920; OE-NO.: 9069972392; MOD: 1823AK;1823K;SA505031/05	8 PK 2045 TM
				ALT	MTR-CODE: OM906.920; OE-NO.: 9069972492; MOD: 1823AK;1823K;SA505031/03	8 PK 1420 TM
				ALT	MTR-CODE: OM906.920; OE-NO.: 9069973592; MOD: 1823AK;1823K;SA505031/21/78	8 PK 1940 TM
				ALT	MTR-CODE: OM906.920; OE-NO.: 9069973692; MOD: 1823AK;1823K;SA505031/22	8 PK 2560 TM
				FAN	MTR-CODE: OM906.920; OE-NO.: 9069973392; MOD: 1823AK;1823K;SA505031/16/56	10 PK 1240 TM
				HYD-P	MTR-CODE: OM906.920; OE-NO.: 9069934496; MOD: 1823AK;1823K;SA505031/96	8 PK 1175 TM
				HYD-P	MTR-CODE: OM906.920; OE-NO.: 9069971392; MOD: 1823AK;1823K;SA505031/25	8 PK 1190 TM
				HYD-P	MTR-CODE: OM906.920; OE-NO.: 9069971392; MOD: 1823AK;1823K;SA505065/03	8 PK 1190 TM

#### 1828

6374 ccm	205 kW	OM 906.921	04.98 - 10.04	AC-C	OE-NO.: 9069971192; MOD: 1828A;1828AK;SA505031/04	8 PK 2080 TM
				AC-C	OE-NO.: 9069971192; MOD: 1828A;1828AK;SA505079/05	8 PK 2080 TM
				ALT	OE-NO.: 9069933996; MOD: 1828A;1828AK;SA505031/77	8 PK 1365 TM
				ALT	OE-NO.: 9069970792; MOD: 1828A;1828AK;SA505031/02	8 PK 1480 TM
				ALT	OE-NO.: 9069970992; MOD: 1828A;1828AK;SA505031/07	8 PK 2605 TM
				ALT	OE-NO.: 9069971292; MOD: 1828A;1828AK;SA505031/06	8 PK 2000 TM
				ALT	OE-NO.: 9069972392; MOD: 1828A;1828AK;SA505031/05	8 PK 2045 TM
				ALT	OE-NO.: 9069972492; MOD: 1828A;1828AK;SA505031/03	8 PK 1420 TM
				ALT	OE-NO.: 9069973592; MOD: 1828A;1828AK;SA505031/21/78	8 PK 1940 TM
				ALT	OE-NO.: 9069973692; MOD: 1828A;1828AK;SA505031/22	8 PK 2560 TM
				FAN	OE-NO.: 9069973392; MOD: 1828A;1828AK;SA505031/16/56	10 PK 1240 TM
				HYD-P	OE-NO.: 9069934496; MOD: 1828A;1828AK;SA505031/96	8 PK 1175 TM
				HYD-P	OE-NO.: 9069971392; MOD: 1828A;1828AK;SA505031/25	8 PK 1190 TM
				HYD-P	OE-NO.: 9069971392; MOD: 1828A;1828AK;SA505065/03	8 PK 1190 TM
		OM 906.921;OM 906.926		AC-C	MTR-CODE: OM906.921; OE-NO.: 9069971192; MOD: 1828A;1828AK;SA505031/04	8 PK 2080 TM
				AC-C	MTR-CODE: OM906.921; OE-NO.: 9069971192; MOD: 1828A;1828AK;SA505079/05	8 PK 2080 TM
				ALT	MTR-CODE: OM906.921; OE-NO.: 9069933996; MOD: 1828A;1828AK;SA505031/77	8 PK 1365 TM
				ALT	MTR-CODE: OM906.921; OE-NO.: 9069970792; MOD: 1828A;1828AK;SA505031/02	8 PK 1480 TM
				ALT	MTR-CODE: OM906.921; OE-NO.: 9069970992; MOD: 1828A;1828AK;SA505031/07	8 PK 2605 TM
				ALT	MTR-CODE: OM906.921; OE-NO.: 9069971292; MOD: 1828A;1828AK;SA505031/06	8 PK 2000 TM



## MERCEDES-BENZ

### ATEGO

#### 1828

6374 ccm	205 kW	OM 906.921;OM 906.926	04.98 - 10.04	ALT	MTR-CODE: OM906.921; OE-NO.: 9069972392; MOD: 1828A;1828AK;SA505031/05	8 PK 2045 TM
				ALT	MTR-CODE: OM906.921; OE-NO.: 9069972492; MOD: 1828A;1828AK;SA505031/03	8 PK 1420 TM
				ALT	MTR-CODE: OM906.921; OE-NO.: 9069973592; MOD: 1828A;1828AK;SA505031/21/78	8 PK 1940 TM
				ALT	MTR-CODE: OM906.921; OE-NO.: 9069973692; MOD: 1828A;1828AK;SA505031/22	8 PK 2560 TM
				FAN	MTR-CODE: OM906.921; OE-NO.: 9069973392; MOD: 1828A;1828AK;SA505031/16/56	10 PK 1240 TM
				HYD-P	MTR-CODE: OM906.921; OE-NO.: 9069934496; MOD: 1828A;1828AK;SA505031/96	8 PK 1175 TM
				HYD-P	MTR-CODE: OM906.921; OE-NO.: 9069971392; MOD: 1828A;1828AK;SA505031/25	8 PK 1190 TM
				HYD-P	MTR-CODE: OM906.921; OE-NO.: 9069971392; MOD: 1828A;1828AK;SA505065/03	8 PK 1190 TM
		OM 906.923		AC-C	MTR-CODE: OM906.921; OE-NO.: 9069971192; MOD: 1828A;1828AK;SA505031/04	8 PK 2080 TM
				AC-C	MTR-CODE: OM906.921; OE-NO.: 9069971192; MOD: 1828A;1828AK;SA505079/05	8 PK 2080 TM
				ALT	MTR-CODE: OM906.921; OE-NO.: 9069933996; MOD: 1828A;1828AK;SA505031/77	8 PK 1365 TM
				ALT	MTR-CODE: OM906.921; OE-NO.: 9069970792; MOD: 1828A;1828AK;SA505031/02	8 PK 1480 TM
				ALT	MTR-CODE: OM906.921; OE-NO.: 9069970992; MOD: 1828A;1828AK;SA505031/07	8 PK 2605 TM
				ALT	MTR-CODE: OM906.921; OE-NO.: 9069971292; MOD: 1828A;1828AK;SA505031/06	8 PK 2000 TM
				ALT	MTR-CODE: OM906.921; OE-NO.: 9069972392; MOD: 1828A;1828AK;SA505031/05	8 PK 2045 TM
				ALT	MTR-CODE: OM906.921; OE-NO.: 9069972492; MOD: 1828A;1828AK;SA505031/03	8 PK 1420 TM
				ALT	MTR-CODE: OM906.921; OE-NO.: 9069973592; MOD: 1828A;1828AK;SA505031/21/78	8 PK 1940 TM
				ALT	MTR-CODE: OM906.921; OE-NO.: 9069973692; MOD: 1828A;1828AK;SA505031/22	8 PK 2560 TM
				FAN	MTR-CODE: OM906.921; OE-NO.: 9069973392; MOD: 1828A;1828AK;SA505031/16/56	10 PK 1240 TM
				HYD-P	MTR-CODE: OM906.921; OE-NO.: 9069934496; MOD: 1828A;1828AK;SA505031/96	8 PK 1175 TM
				HYD-P	MTR-CODE: OM906.921; OE-NO.: 9069971392; MOD: 1828A;1828AK;SA505031/25	8 PK 1190 TM
				HYD-P	MTR-CODE: OM906.921; OE-NO.: 9069971392; MOD: 1828A;1828AK;SA505065/03	8 PK 1190 TM

#### 2523

6374 ccm	170 kW	OM 906.920	04.98 - 10.04	AC-C	OE-NO.: 9069971192; MOD: 2523L;SA505031/04	8 PK 2080 TM
				AC-C	OE-NO.: 9069971192; MOD: 2523L;SA505079/05	8 PK 2080 TM
				ALT	OE-NO.: 9069933996; MOD: 2523L;SA505031/77	8 PK 1365 TM
				ALT	OE-NO.: 9069970792; MOD: 2523L;SA505031/02	8 PK 1480 TM
				ALT	OE-NO.: 9069970992; MOD: 2523L;SA505031/07	8 PK 2605 TM
				ALT	OE-NO.: 9069971292; MOD: 2523L;SA505031/06	8 PK 2000 TM
				ALT	OE-NO.: 9069972392; MOD: 2523L;SA505031/05	8 PK 2045 TM
				ALT	OE-NO.: 9069972492; MOD: 2523L;SA505031/03	8 PK 1420 TM
				ALT	OE-NO.: 9069973592; MOD: 2523L;SA505031/21/78	8 PK 1940 TM
				ALT	OE-NO.: 9069973692; MOD: 2523L;SA505031/22	8 PK 2560 TM
				FAN	OE-NO.: 9069973392; MOD: 2523L;SA505031/16/56	10 PK 1240 TM
				HYD-P	OE-NO.: 9069934496; MOD: 2523L;SA505031/96	8 PK 1175 TM
				HYD-P	OE-NO.: 9069971392; MOD: 2523L;SA505031/25	8 PK 1190 TM
				HYD-P	OE-NO.: 9069971392; MOD: 2523L;SA505065/03	8 PK 1190 TM

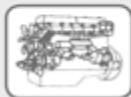

## MERCEDES-BENZ

### ATEGO

#### 2528

6374 ccm	205 kW	OM 906.921;OM 906.926	04.98 - 10.04	AC-C	MTR-CODE: OM906.921; OE-NO.: 9069971192; MOD: 2528L;SA505031/04	8 PK 2080 TM
				AC-C	MTR-CODE: OM906.921; OE-NO.: 9069971192; MOD: 2528L;SA505079/05	8 PK 2080 TM
				ALT	MTR-CODE: OM906.921; OE-NO.: 9069933996; MOD: 2528L;SA505031/77	8 PK 1365 TM
				ALT	MTR-CODE: OM906.921; OE-NO.: 9069970792; MOD: 2528L;SA505031/02	8 PK 1480 TM
				ALT	MTR-CODE: OM906.921; OE-NO.: 9069970992; MOD: 2528L;SA505031/07	8 PK 2605 TM
				ALT	MTR-CODE: OM906.921; OE-NO.: 9069971292; MOD: 2528L;SA505031/06	8 PK 2000 TM
				ALT	MTR-CODE: OM906.921; OE-NO.: 9069972392; MOD: 2528L;SA505031/05	8 PK 2045 TM
				ALT	MTR-CODE: OM906.921; OE-NO.: 9069972492; MOD: 2528L;SA505031/03	8 PK 1420 TM
				ALT	MTR-CODE: OM906.921; OE-NO.: 9069973592; MOD: 2528L;SA505031/21/78	8 PK 1940 TM
				ALT	MTR-CODE: OM906.921; OE-NO.: 9069973692; MOD: 2528L;SA505031/22	8 PK 2560 TM
				FAN	MTR-CODE: OM906.921; OE-NO.: 9069973392; MOD: 2528L;SA505031/16/56	10 PK 1240 TM
				HYD-P	MTR-CODE: OM906.921; OE-NO.: 9069934496; MOD: 2528L;SA505031/96	8 PK 1175 TM
				HYD-P	MTR-CODE: OM906.921; OE-NO.: 9069971392; MOD: 2528L;SA505031/25	8 PK 1190 TM
				HYD-P	MTR-CODE: OM906.921; OE-NO.: 9069971392; MOD: 2528L;SA505065/03	8 PK 1190 TM

#### 2628

6374 ccm	205 kW	OM 906.921	04.98 - 10.04	AC-C	OE-NO.: 9069971192; MOD: 2628;2628B;2628K;SA505031/04	8 PK 2080 TM
				AC-C	OE-NO.: 9069971192; MOD: 2628;2628B;2628K;SA505079/05	8 PK 2080 TM
				ALT	OE-NO.: 9069933996; MOD: 2628;2628B;2628K;SA505031/77	8 PK 1365 TM
				ALT	OE-NO.: 9069970792; MOD: 2628;2628B;2628K;SA505031/02	8 PK 1480 TM
				ALT	OE-NO.: 9069970992; MOD: 2628;2628B;2628K;SA505031/07	8 PK 2605 TM
				ALT	OE-NO.: 9069971292; MOD: 2628;2628B;2628K;SA505031/06	8 PK 2000 TM
				ALT	OE-NO.: 9069972392; MOD: 2628;2628B;2628K;SA505031/05	8 PK 2045 TM
				ALT	OE-NO.: 9069972492; MOD: 2628;2628B;2628K;SA505031/03	8 PK 1420 TM
				ALT	OE-NO.: 9069973592; MOD: 2628;2628B;2628K;SA505031/21/78	8 PK 1940 TM
				ALT	OE-NO.: 9069973692; MOD: 2628;2628B;2628K;SA505031/22	8 PK 2560 TM
				FAN	OE-NO.: 9069973392; MOD: 2628;2628B;2628K;SA505031/16/56	10 PK 1240 TM
				HYD-P	OE-NO.: 9069934496; MOD: 2628;2628B;2628K;SA505031/96	8 PK 1175 TM
				HYD-P	OE-NO.: 9069971392; MOD: 2628;2628B;2628K;SA505031/25	8 PK 1190 TM
				HYD-P	OE-NO.: 9069971392; MOD: 2628;2628B;2628K;SA505065/03	8 PK 1190 TM

#### 712

4249 ccm	90 kW	OM 904.909	01.98 - 10.04	AC-C	MTR-CODE: OM904.916; MOD: 714	8 PK 2080 TM
				ALT	MTR-CODE: OM904.909; OE-NO.: 9069933996; MOD: 712;715,715L;SA505031/77	8 PK 1365 TM
				ALT	MTR-CODE: OM904.909; OE-NO.: 9069934096; MOD: 712;715,715L;SA505031/78	8 PK 1940 TM
				ALT	MTR-CODE: OM904.909; OE-NO.: 9069970792; MOD: 712;715,715L;SA505031/02	8 PK 1480 TM
				ALT	MTR-CODE: OM904.909; OE-NO.: 9069970992; MOD: 712;715,715L;SA505031/07	8 PK 2605 TM
				ALT	MTR-CODE: OM904.909; OE-NO.: 9069971192; MOD: 712;715,715L;SA505031/04	8 PK 2080 TM
				ALT	MTR-CODE: OM904.909; OE-NO.: 9069971292; MOD: 712;715,715L;SA505031/06	8 PK 2000 TM
				ALT	MTR-CODE: OM904.909; OE-NO.: 9069972392; MOD: 712;715,715L;SA505031/05	8 PK 2045 TM



## MERCEDES-BENZ

### ATEGO

#### 712

4249 ccm	90 kW	OM 904.909	01.98 - 10.04	ALT	MTR-CODE: OM904.916; OE-NO.: 9069933996; MOD: 714;SA505031/77	<b>8 PK 1365 TM</b>
				ALT	MTR-CODE: OM904.916; OE-NO.: 9069934096; MOD: 714;SA505031/78	<b>8 PK 1940 TM</b>
				ALT	MTR-CODE: OM904.916; OE-NO.: 9069970792; MOD: 714;SA505031/02	<b>8 PK 1480 TM</b>
				ALT	MTR-CODE: OM904.916; OE-NO.: 9069970992; MOD: 714;SA505031/07	<b>8 PK 2605 TM</b>
				ALT	MTR-CODE: OM904.916; OE-NO.: 9069971192; MOD: 714;SA505031/04	<b>8 PK 2080 TM</b>
				ALT	MTR-CODE: OM904.916; OE-NO.: 9069971292; MOD: 714;SA505031/06	<b>8 PK 2000 TM</b>
				ALT	MTR-CODE: OM904.916; OE-NO.: 9069972392; MOD: 714;SA505031/05	<b>8 PK 2045 TM</b>
				ALT	MTR-CODE: OM904.916; OE-NO.: 9069973092; MOD: 714;SA505031/14	<b>8 PK 1230 TM</b>
				ALT; 1. ALT	MTR-CODE: OM904.909; OE-NO.: 9069973092; MOD: 712;715,715L;SA505031/14	<b>8 PK 1230 TM</b>
				HYD-P	MTR-CODE: OM904.909; OE-NO.: 9069971492; MOD: 712;715,715L;SA505031/24	<b>8 PK 1175 TM</b>
				HYD-P	MTR-CODE: OM904.909; OE-NO.: 9069971492; MOD: 712;715,715L;SA505065/01	<b>8 PK 1175 TM</b>
				HYD-P	MTR-CODE: OM904.916; MOD: 714;SA505031/24	<b>8 PK 1175 TM</b>
				HYD-P	MTR-CODE: OM904.916; MOD: 714;SA505065/01	<b>8 PK 1175 TM</b>

#### 715

4249 ccm	112 kW	OM 904.922	01.98 - 10.04	AC-C	MTR-CODE: OM904.916; MOD: 714	<b>8 PK 2080 TM</b>
				AC-C	MTR-CODE: OM904.916; OE-NO.: 9069971192; MOD: 714;SA505031/04	<b>8 PK 2080 TM</b>
				ALT	MTR-CODE: OM904.909; OE-NO.: 9069933996; MOD: 712;715,715L;SA505031/77	<b>8 PK 1365 TM</b>
				ALT	MTR-CODE: OM904.909; OE-NO.: 9069934096; MOD: 712;715,715L;SA505031/78	<b>8 PK 1940 TM</b>
				ALT	MTR-CODE: OM904.909; OE-NO.: 9069970792; MOD: 712;715,715L;SA505031/02	<b>8 PK 1480 TM</b>
				ALT	MTR-CODE: OM904.909; OE-NO.: 9069970992; MOD: 712;715,715L;SA505031/07	<b>8 PK 2605 TM</b>
				ALT	MTR-CODE: OM904.909; OE-NO.: 9069971192; MOD: 712;715,715L;SA505031/04	<b>8 PK 2080 TM</b>
				ALT	MTR-CODE: OM904.909; OE-NO.: 9069971292; MOD: 712;715,715L;SA505031/06	<b>8 PK 2000 TM</b>
				ALT	MTR-CODE: OM904.909; OE-NO.: 9069972392; MOD: 712;715,715L;SA505031/05	<b>8 PK 2045 TM</b>
				ALT	MTR-CODE: OM904.916; OE-NO.: 9069933996; MOD: 714;SA505031/77	<b>8 PK 1365 TM</b>
				ALT	MTR-CODE: OM904.916; OE-NO.: 9069934096; MOD: 714;SA505031/78	<b>8 PK 1940 TM</b>
				ALT	MTR-CODE: OM904.916; OE-NO.: 9069970792; MOD: 714;SA505031/02	<b>8 PK 1480 TM</b>
				ALT	MTR-CODE: OM904.916; OE-NO.: 9069970992; MOD: 714;SA505031/07	<b>8 PK 2605 TM</b>
				ALT	MTR-CODE: OM904.916; OE-NO.: 9069971292; MOD: 714;SA505031/06	<b>8 PK 2000 TM</b>
				ALT	MTR-CODE: OM904.916; OE-NO.: 9069972392; MOD: 714;SA505031/05	<b>8 PK 2045 TM</b>
				ALT	MTR-CODE: OM904.916; OE-NO.: 9069973092; MOD: 714;SA505031/14	<b>8 PK 1230 TM</b>
				ALT; 1. ALT	MTR-CODE: OM904.909; OE-NO.: 9069973092; MOD: 712;715,715L;SA505031/14	<b>8 PK 1230 TM</b>
				HYD-P	MTR-CODE: OM904.909; OE-NO.: 9069971492; MOD: 712;715,715L;SA505031/24	<b>8 PK 1175 TM</b>
				HYD-P	MTR-CODE: OM904.909; OE-NO.: 9069971492; MOD: 712;715,715L;SA505065/01	<b>8 PK 1175 TM</b>
				HYD-P	MTR-CODE: OM904.916; MOD: 714;SA505031/24	<b>8 PK 1175 TM</b>
				HYD-P	MTR-CODE: OM904.916; MOD: 714;SA505065/01	<b>8 PK 1175 TM</b>

#### 812

4249 ccm	90 kW	OM 904.909	01.98 - 10.04	AC-C	MOD: 812;815F;815K	<b>8 PK 2080 TM</b>
				ALT	OE-NO.: 9069933996; MOD: 812;815F;815K;SA505031/77	<b>8 PK 1365 TM</b>
				ALT	OE-NO.: 9069934096; MOD: 812;815F;815K;SA505031/78	<b>8 PK 1940 TM</b>



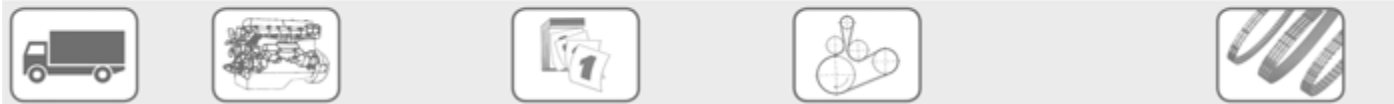

## MERCEDES-BENZ

### ATEGO

#### 812

4249 ccm	90 kW	OM 904.909	01.98 - 10.04	ALT	OE-NO.: 9069970792; MOD: 812;815F;815K;SA505031/02	8 PK 1480 TM
				ALT	OE-NO.: 9069970992; MOD: 812;815F;815K;SA505031/07	8 PK 2605 TM
				ALT	OE-NO.: 9069971192; MOD: 812;815F;815K;SA505031/04	8 PK 2080 TM
				ALT	OE-NO.: 9069971292; MOD: 812;815F;815K;SA505031/06	8 PK 2000 TM
				ALT	OE-NO.: 9069972392; MOD: 812;815F;815K;SA505031/05	8 PK 2045 TM
				ALT; 1. ALT	OE-NO.: 9069973092; MOD: 812;815F;815K;SA505031/14	8 PK 1230 TM
				HYD-P	MOD: 812;815F;815K;SA505031/24	8 PK 1175 TM
				HYD-P	MOD: 812;815F;815K;SA505065/01	8 PK 1175 TM

#### 815

4249 ccm	112-115 kW	OM 900.912;OM 904.922	01.98 - 10.04	AC-C	MTR-CODE: OM904.909; MOD: 812;815F;815K	8 PK 2080 TM
				ALT	MTR-CODE: OM904.909; OE-NO.: 9069933996; MOD: 812;815F;815K;SA505031/77	8 PK 1365 TM
				ALT	MTR-CODE: OM904.909; OE-NO.: 9069934096; MOD: 812;815F;815K;SA505031/78	8 PK 1940 TM
				ALT	MTR-CODE: OM904.909; OE-NO.: 9069970792; MOD: 812;815F;815K;SA505031/02	8 PK 1480 TM
				ALT	MTR-CODE: OM904.909; OE-NO.: 9069970992; MOD: 812;815F;815K;SA505031/07	8 PK 2605 TM
				ALT	MTR-CODE: OM904.909; OE-NO.: 9069971192; MOD: 812;815F;815K;SA505031/04	8 PK 2080 TM
				ALT	MTR-CODE: OM904.909; OE-NO.: 9069971292; MOD: 812;815F;815K;SA505031/06	8 PK 2000 TM
				ALT	MTR-CODE: OM904.909; OE-NO.: 9069972392; MOD: 812;815F;815K;SA505031/05	8 PK 2045 TM
				ALT; 1. ALT	MTR-CODE: OM904.909; OE-NO.: 9069973092; MOD: 812;815F;815K;SA505031/14	8 PK 1230 TM
				HYD-P	MTR-CODE: OM904.909; MOD: 812;815F;815K;SA505031/24	8 PK 1175 TM
				HYD-P	MTR-CODE: OM904.909; MOD: 812;815F;815K;SA505065/01	8 PK 1175 TM
	112 kW	OM 904.922		AC-C	MTR-CODE: OM904.909; MOD: 812;815F;815K	8 PK 2080 TM
				ALT	MTR-CODE: OM904.909; OE-NO.: 9069933996; MOD: 812;815F;815K;SA505031/77	8 PK 1365 TM
				ALT	MTR-CODE: OM904.909; OE-NO.: 9069934096; MOD: 812;815F;815K;SA505031/78	8 PK 1940 TM
				ALT	MTR-CODE: OM904.909; OE-NO.: 9069970792; MOD: 812;815F;815K;SA505031/02	8 PK 1480 TM
				ALT	MTR-CODE: OM904.909; OE-NO.: 9069970992; MOD: 812;815F;815K;SA505031/07	8 PK 2605 TM
				ALT	MTR-CODE: OM904.909; OE-NO.: 9069971192; MOD: 812;815F;815K;SA505031/04	8 PK 2080 TM
				ALT	MTR-CODE: OM904.909; OE-NO.: 9069971292; MOD: 812;815F;815K;SA505031/06	8 PK 2000 TM
				ALT	MTR-CODE: OM904.909; OE-NO.: 9069972392; MOD: 812;815F;815K;SA505031/05	8 PK 2045 TM
				ALT; 1. ALT	MTR-CODE: OM904.909; OE-NO.: 9069973092; MOD: 812;815F;815K;SA505031/14	8 PK 1230 TM
				HYD-P	MTR-CODE: OM904.909; MOD: 812;815F;815K;SA505031/24	8 PK 1175 TM
				HYD-P	MTR-CODE: OM904.909; MOD: 812;815F;815K;SA505065/01	8 PK 1175 TM

#### 817

4249 ccm	125 kW	OM 904.911	01.98 - 10.04	AC-C	MTR-CODE: OM904.909; MOD: 812;815F;815K	8 PK 2080 TM
				ALT	MTR-CODE: OM904.909; OE-NO.: 9069933996; MOD: 812;815F;815K;SA505031/77	8 PK 1365 TM
				ALT	MTR-CODE: OM904.909; OE-NO.: 9069934096; MOD: 812;815F;815K;SA505031/78	8 PK 1940 TM
				ALT	MTR-CODE: OM904.909; OE-NO.: 9069970792; MOD: 812;815F;815K;SA505031/02	8 PK 1480 TM
				ALT	MTR-CODE: OM904.909; OE-NO.: 9069970992; MOD: 812;815F;815K;SA505031/07	8 PK 2605 TM
				ALT	MTR-CODE: OM904.909; OE-NO.: 9069971192; MOD: 812;815F;815K;SA505031/04	8 PK 2080 TM
				ALT	MTR-CODE: OM904.909; OE-NO.: 9069971292; MOD: 812;815F;815K;SA505031/06	8 PK 2000 TM
				ALT	MTR-CODE: OM904.909; OE-NO.: 9069972392; MOD: 812;815F;815K;SA505031/05	8 PK 2045 TM



## MERCEDES-BENZ

### ATEGO

#### 817

4249 ccm	125 kW	OM 904.911	01.98 - 10.04	ALT; 1. ALT	MTR-CODE: OM904.909; OE-NO.: 9069973092; MOD: 812;815F;815K;SA505031/14	<b>8 PK 1230 TM</b>
				HYD-P	MTR-CODE: OM904.909; MOD: 812;815F;815K;SA505031/24	<b>8 PK 1175 TM</b>
				HYD-P	MTR-CODE: OM904.909; MOD: 812;815F;815K;SA505065/01	<b>8 PK 1175 TM</b>
		OM 904.911;OM 904.917		AC-C	MTR-CODE: OM904.909; MOD: 812;815F;815K	<b>8 PK 2080 TM</b>
				ALT	MTR-CODE: OM904.909; OE-NO.: 9069933996; MOD: 812;815F;815K;SA505031/77	<b>8 PK 1365 TM</b>
				ALT	MTR-CODE: OM904.909; OE-NO.: 9069934096; MOD: 812;815F;815K;SA505031/78	<b>8 PK 1940 TM</b>
				ALT	MTR-CODE: OM904.909; OE-NO.: 9069970792; MOD: 812;815F;815K;SA505031/02	<b>8 PK 1480 TM</b>
				ALT	MTR-CODE: OM904.909; OE-NO.: 9069970992; MOD: 812;815F;815K;SA505031/07	<b>8 PK 2605 TM</b>
				ALT	MTR-CODE: OM904.909; OE-NO.: 9069971192; MOD: 812;815F;815K;SA505031/04	<b>8 PK 2080 TM</b>
				ALT	MTR-CODE: OM904.909; OE-NO.: 9069971292; MOD: 812;815F;815K;SA505031/06	<b>8 PK 2000 TM</b>
				ALT	MTR-CODE: OM904.909; OE-NO.: 9069972392; MOD: 812;815F;815K;SA505031/05	<b>8 PK 2045 TM</b>
				ALT; 1. ALT	MTR-CODE: OM904.909; OE-NO.: 9069973092; MOD: 812;815F;815K;SA505031/14	<b>8 PK 1230 TM</b>
				HYD-P	MTR-CODE: OM904.909; MOD: 812;815F;815K;SA505031/24	<b>8 PK 1175 TM</b>
				HYD-P	MTR-CODE: OM904.909; MOD: 812;815F;815K;SA505065/01	<b>8 PK 1175 TM</b>

#### 823

6374 ccm	170 kW	OM 906.910;OM 906.915	01.98 - 10.04	AC-C	MOD: 823K;823,823L	<b>8 PK 2080 TM</b>
				ALT	OE-NO.: 9069933996; MOD: 823K;823,823L;SA505031/77	<b>8 PK 1365 TM</b>
				ALT	OE-NO.: 9069934096; MOD: 823K;823,823L;SA505031/78	<b>8 PK 1940 TM</b>
				ALT	OE-NO.: 9069970792; MOD: 823K;823,823L;SA505031/02	<b>8 PK 1480 TM</b>
				ALT	OE-NO.: 9069970992; MOD: 823K;823,823L;SA505031/07	<b>8 PK 2605 TM</b>
				ALT	OE-NO.: 9069971192; MOD: 823K;823,823L;SA505079/05	<b>8 PK 2080 TM</b>
				ALT	OE-NO.: 9069971292; MOD: 823K;823,823L;SA505031/06	<b>8 PK 2000 TM</b>
				ALT	OE-NO.: 9069972392; MOD: 823K;823,823L;SA505031/05	<b>8 PK 2045 TM</b>
				ALT	OE-NO.: 9069972492; MOD: 823K;823,823L;SA505031/03	<b>8 PK 1420 TM</b>
				ALT	OE-NO.: 9069973592; MOD: 823K;823,823L;SA505031/21	<b>8 PK 1940 TM</b>
				ALT	OE-NO.: 9069973692; MOD: 823K;823,823L;SA505031/22	<b>8 PK 2560 TM</b>
				FAN	OE-NO.: 9069932896; MOD: 823K;823,823L;SA505031/56	<b>10 PK 1240 TM</b>
				HYD-P	OE-NO.: 9069934496; MOD: 823K;823,823L;SA505031/96	<b>8 PK 1175 TM</b>
				HYD-P	OE-NO.: 9069934596; MOD: 823K;823,823L;SA505031/25	<b>8 PK 1190 TM</b>
				HYD-P	OE-NO.: 9069934596; MOD: 823K;823,823L;SA505065/03	<b>8 PK 1190 TM</b>

#### 917

4249 ccm	125 kW	OM 904.911;OM 904.917	01.98 - 10.04	AC-C	MOD: 917AF;917K	<b>8 PK 2080 TM</b>
				ALT	OE-NO.: 9069933996; MOD: 917AF;917K;SA505031/77	<b>8 PK 1365 TM</b>
				ALT	OE-NO.: 9069934096; MOD: 917AF;917K;SA505031/78	<b>8 PK 1940 TM</b>
				ALT	OE-NO.: 9069970792; MOD: 917AF;917K;SA505031/02	<b>8 PK 1480 TM</b>
				ALT	OE-NO.: 9069970992; MOD: 917AF;917K;SA505031/07	<b>8 PK 2605 TM</b>
				ALT	OE-NO.: 9069971192; MOD: 917AF;917K;SA505031/04	<b>8 PK 2080 TM</b>
				ALT	OE-NO.: 9069971292; MOD: 917AF;917K;SA505031/06	<b>8 PK 2000 TM</b>
				ALT	OE-NO.: 9069972392; MOD: 917AF;917K;SA505031/05	<b>8 PK 2045 TM</b>



## MERCEDES-BENZ

### ATEGO

#### 917

4249 ccm	125 kW	OM 904.911;OM 904.917	01.98 - 10.04	ALT; 1. ALT	OE-NO.: 9069973092; MOD: 917AF;917K;SA505031/14	8 PK 1230 TM
				HYD-P	MOD: 917AF;917K;SA505031/24	8 PK 1175 TM
				HYD-P	MOD: 917AF;917K;SA505065/01	8 PK 1175 TM
	125-128 kW	OM 904.911;OM 904.917;OM 904.949		AC-C	MTR-CODE: OM904.911; MOD: 917AF;917K	8 PK 2080 TM
				ALT	MTR-CODE: OM904.911; OE-NO.: 9069933996; MOD: 917AF;917K;SA505031/77	8 PK 1365 TM
				ALT	MTR-CODE: OM904.911; OE-NO.: 9069934096; MOD: 917AF;917K;SA505031/78	8 PK 1940 TM
				ALT	MTR-CODE: OM904.911; OE-NO.: 9069970792; MOD: 917AF;917K;SA505031/02	8 PK 1480 TM
				ALT	MTR-CODE: OM904.911; OE-NO.: 9069970992; MOD: 917AF;917K;SA505031/07	8 PK 2605 TM
				ALT	MTR-CODE: OM904.911; OE-NO.: 9069971192; MOD: 917AF;917K;SA505031/04	8 PK 2080 TM
				ALT	MTR-CODE: OM904.911; OE-NO.: 9069971292; MOD: 917AF;917K;SA505031/06	8 PK 2000 TM
				ALT	MTR-CODE: OM904.911; OE-NO.: 9069972392; MOD: 917AF;917K;SA505031/05	8 PK 2045 TM
				ALT; 1. ALT	MTR-CODE: OM904.911; OE-NO.: 9069973092; MOD: 917AF;917K;SA505031/14	8 PK 1230 TM
				HYD-P	MTR-CODE: OM904.911; MOD: 917AF;917K;SA505031/24	8 PK 1175 TM
				HYD-P	MTR-CODE: OM904.911; MOD: 917AF;917K;SA505065/01	8 PK 1175 TM

#### 923

6374 ccm	170 kW	OM 906.910	01.98 - 10.04	AC-C	MOD: 923,923L	8 PK 2080 TM
				ALT	OE-NO.: 9069933996; MOD: 923,923L;SA505031/77	8 PK 1365 TM
				ALT	OE-NO.: 9069934096; MOD: 923,923L;SA505031/78	8 PK 1940 TM
				ALT	OE-NO.: 9069970792; MOD: 923,923L;SA505031/02	8 PK 1480 TM
				ALT	OE-NO.: 9069970992; MOD: 923,923L;SA505031/07	8 PK 2605 TM
				ALT	OE-NO.: 9069971192; MOD: 923,923L;SA505079/05	8 PK 2080 TM
				ALT	OE-NO.: 9069971292; MOD: 923,923L;SA505031/06	8 PK 2000 TM
				ALT	OE-NO.: 9069972392; MOD: 923,923L;SA505031/05	8 PK 2045 TM
				ALT	OE-NO.: 9069972492; MOD: 923,923L;SA505031/03	8 PK 1420 TM
				ALT	OE-NO.: 9069973592; MOD: 923,923L;SA505031/21	8 PK 1940 TM
				ALT	OE-NO.: 9069973692; MOD: 923,923L;SA505031/22	8 PK 2560 TM
				FAN	OE-NO.: 9069932896; MOD: 923,923L;SA505031/56	10 PK 1240 TM
				HYD-P	OE-NO.: 9069934496; MOD: 923,923L;SA505031/96	8 PK 1175 TM
				HYD-P	OE-NO.: 9069934596; MOD: 923,923L;SA505031/25	8 PK 1190 TM
				HYD-P	OE-NO.: 9069934596; MOD: 923,923L;SA505065/03	8 PK 1190 TM

#### 925

6374 ccm	180 kW	OM 906.919;OM 906.939	01.98 - 10.04	AC-C	OE-NO.: 9069971192; MOD: 925AF;SA505079/05	8 PK 2080 TM
				ALT	OE-NO.: 9069933996; MOD: 925AF;SA505031/77	8 PK 1365 TM
				ALT	OE-NO.: 9069934096; MOD: 925AF;SA505031/78	8 PK 1940 TM
				ALT	OE-NO.: 9069970792; MOD: 925AF;SA505031/02	8 PK 1480 TM
				ALT	OE-NO.: 9069970992; MOD: 925AF;SA505031/07	8 PK 2605 TM
				ALT	OE-NO.: 9069971192; MOD: 925AF;SA505031/04	8 PK 2080 TM
				ALT	OE-NO.: 9069971292; MOD: 925AF;SA505031/06	8 PK 2000 TM
				ALT	OE-NO.: 9069972392; MOD: 925AF;SA505031/05	8 PK 2045 TM



## MERCEDES-BENZ

### ATEGO

#### 925

6374 ccm	180 kW	OM 906.919;OM 906.939	01.98 - 10.04	ALT	OE-NO.: 9069972492; MOD: 925AF;SA505031/03	8 PK 1420 TM
				ALT	OE-NO.: 9069973592; MOD: 925AF;SA505031/21	8 PK 1940 TM
				ALT	OE-NO.: 9069973692; MOD: 925AF;SA505031/22	8 PK 2560 TM
				FAN	OE-NO.: 9069932896; MOD: 925AF;SA505031/56	10 PK 1240 TM
				FAN	OE-NO.: 9069973392; MOD: 925AF;SA505031/16	10 PK 1240 TM
				HYD-P	OE-NO.: 9069934496; MOD: 925AF;SA505031/96	8 PK 1175 TM
				HYD-P	OE-NO.: 9069971392; MOD: 925AF;SA505031/25	8 PK 1190 TM
				HYD-P	OE-NO.: 9069971392; MOD: 925AF;SA505065/03	8 PK 1190 TM

### AXOR

#### 1823

6374 ccm	170 kW	OM 906.920	01.02 - 10.04	ALT	OE-NO.: 9069933996; MOD: 1823;1823K;SA50503177	8 PK 1365 TM
				ALT	OE-NO.: 9069934096; MOD: 1823;1823K;SA50503178	8 PK 1940 TM
				ALT	OE-NO.: 9069970792; MOD: 1823;1823K;SA50503102	8 PK 1480 TM
				ALT	OE-NO.: 9069970992; MOD: 1823;1823K;SA50503107	8 PK 2605 TM
				ALT	OE-NO.: 9069971192; MOD: 1823;1823K;SA50507905	8 PK 2080 TM
				ALT	OE-NO.: 9069971292; MOD: 1823;1823K;SA50503106	8 PK 2000 TM
				ALT	OE-NO.: 9069972392; MOD: 1823;1823K;SA50503105	8 PK 2045 TM
				ALT	OE-NO.: 9069972492; MOD: 1823;1823K;SA50503103	8 PK 1420 TM
				ALT	OE-NO.: 9069973592; MOD: 1823;1823K;SA50503121	8 PK 1940 TM
				ALT	OE-NO.: 9069973692; MOD: 1823;1823K;SA50503122	8 PK 2560 TM
				FAN	OE-NO.: 9069932896; MOD: 1823;1823K;SA50503156	10 PK 1240 TM
				FAN	OE-NO.: 9069973392; MOD: 1823;1823K;SA50503116	10 PK 1240 TM
				HYD-P	OE-NO.: 9069934496; MOD: 1823;1823K;SA505031/96	8 PK 1175 TM
				HYD-P	OE-NO.: 9069971392; MOD: 1823;1823K;SA505031/25	8 PK 1190 TM
				HYD-P	OE-NO.: 9069971392; MOD: 1823;1823K;SA505065/03	8 PK 1190 TM

#### 1835

11967 ccm	260 kW	OM 457.937	01.02 - 10.04	AIR-C	OE-NO.: 0139978292; MOD: 1835 LS;1840 LS; UP; + DYN	AVX 13 x 950 TM
				ALT	FROM MTR-NO: 002988; OE-NO.: 0149977892; MOD: 1835LS;1840LS;SA52205610	8 PK 1610 TM
				ALT	FROM MTR-NO: 002988; OE-NO.: 0149977892; MOD: 1835LS;1840LS;SA53273602	8 PK 1610 TM
				ALT	OE-NO.: 0019932596; MOD: 1835LS;1840LS;SA53273608	8 PK 1610 TM
				ALT	OE-NO.: 0159973292; MOD: 1835LS;1840LS;SA53273602	8 PK 1610 TM
				FAN	MOD: AXOR, 1835LS/ 1840LS;SA532736 01; FROM MTR-NO: 002988; OE-NO.: 0149975292; MTR-CODE: OM 457.937	12 PK 1400 TM
				FAN	MTR-CODE: OM 457.937; MOD: SA 522056 10;AXOR;1835 LS/1840 LS; OE-NO.: 0159971192	9 PK 1610 TM
				FAN	OE-NO.: 0159972192; MOD: 1835LS;1840LS; UP	9 PK 1780 TM
				W-P	FROM MTR-NO: 002988; OE-NO.: 0019932796; MOD: 1835LS;1840LS;SA53273606	9 PK 2140 TM
				W-P	FROM MTR-NO: 002988; OE-NO.: 0149976092; MOD: 1835LS;1840LS;SA52205617	9 PK 2100 TM
				W-P	FROM MTR-NO: 002988; OE-NO.: 0149976092; MOD: 1835LS;1840LS;SA53273603	9 PK 2100 TM



## MERCEDES-BENZ

### AXOR

#### 1835

11967 ccm	260 kW	OM 457.937	01.02 - 10.04	W-P	FROM MTR-NO: 002988; OE-NO.: 0149976892; MOD: 1835LS;1840LS;SA52205622	<b>9 PK 2295 TM</b>
				W-P	OE-NO.: 0149976892; MOD: 1835LS;1840LS;SA53273604	<b>9 PK 2295 TM</b>
				W-P	OE-NO.: 0159971792; MOD: 1835LS;1840LS	<b>9 PK 2010 TM</b>
				W-P	UNTIL MTR-NO: 002987; OE-NO.: 0139976192; MOD: 1835LS;1840LS;SA52205617	<b>9 PK 2060 TM</b>

#### 1840

11967 ccm	295 kW	OM 457.937	01.02 - 10.04	AIR-C	OE-NO.: 0139978292; MOD: 1835 LS;1840 LS; UP	<b>AVX 13 x 950 TM</b>
				ALT	FROM MTR-NO: 002988; OE-NO.: 0149977892; MOD: 1835LS;1840LS;SA52205610	<b>8 PK 1610 TM</b>
				ALT	FROM MTR-NO: 002988; OE-NO.: 0149977892; MOD: 1835LS;1840LS;SA53273602	<b>8 PK 1610 TM</b>
				ALT	OE-NO.: 0019932596; MOD: 1835LS;1840LS;SA53273608	<b>8 PK 1610 TM</b>
				ALT	OE-NO.: 0159973292; MOD: 1835LS;1840LS;SA53273602	<b>8 PK 1610 TM</b>
				FAN	MTR-CODE: OM 457.937; MOD: AXOR, 1835LS/ 1840LS;SA532736 01; FROM MTR-NO: 002988; OE-NO.: 0149975292	<b>12 PK 1400 TM</b>
				FAN	MTR-CODE: OM 457.937; MOD: SA 522056 10;AXOR;1835 LS/1840 LS; OE-NO.: 0159971192	<b>9 PK 1610 TM</b>
				FAN	OE-NO.: 0159972192; MOD: 1835LS;1840LS; UP	<b>9 PK 1780 TM</b>
				W-P	FROM MTR-NO: 002988; OE-NO.: 0019932796; MOD: 1835LS;1840LS;SA53273606	<b>9 PK 2140 TM</b>
				W-P	FROM MTR-NO: 002988; OE-NO.: 0149976092; MOD: 1835LS;1840LS;SA52205617	<b>9 PK 2100 TM</b>
				W-P	FROM MTR-NO: 002988; OE-NO.: 0149976092; MOD: 1835LS;1840LS;SA53273603	<b>9 PK 2100 TM</b>
				W-P	FROM MTR-NO: 002988; OE-NO.: 0149976892; MOD: 1835LS;1840LS;SA52205622	<b>9 PK 2295 TM</b>
				W-P	OE-NO.: 0149976892; MOD: 1835LS;1840LS;SA53273604	<b>9 PK 2295 TM</b>
				W-P	OE-NO.: 0159971792; MOD: 1835LS;1840LS	<b>9 PK 2010 TM</b>
				W-P	UNTIL MTR-NO: 002987; OE-NO.: 0139976192; MOD: 1835LS;1840LS;SA52205617	<b>9 PK 2060 TM</b>

#### 1843

11967 ccm	315 kW	OM 457.937	01.02 - 10.04	AIR-C	OE-NO.: 0139978292; MOD: 1835 LS;1840 LS; UP	<b>AVX 13 x 950 TM</b>
				ALT	FROM MTR-NO: 002988; OE-NO.: 0149977892; MOD: 1835LS;1840LS;SA52205610	<b>8 PK 1610 TM</b>
				ALT	FROM MTR-NO: 002988; OE-NO.: 0149977892; MOD: 1835LS;1840LS;SA53273602	<b>8 PK 1610 TM</b>
				ALT	OE-NO.: 0019932596; MOD: 1835LS;1840LS;SA53273608	<b>8 PK 1610 TM</b>
				ALT	OE-NO.: 0159973292; MOD: 1835LS;1840LS;SA53273602	<b>8 PK 1610 TM</b>
				FAN	MOD: Kerax;370.18; OE-NO.: 5010477838; MTR-CODE: dCi 11E	<b>9 PK 1690 TM</b>
				FAN	MTR-CODE: OM 457.937; MOD: AXOR, 1835LS/ 1840LS;SA532736 01; FROM MTR-NO: 002988; OE-NO.: 0149975292	<b>12 PK 1400 TM</b>
				FAN	MTR-CODE: OM 457.937; MOD: AXOR;1835 LS/1840 LS;SA522056 10; OE-NO.: 0159971192	<b>9 PK 1610 TM</b>
				FAN	OE-NO.: 0159972192; MOD: 1835LS;1840LS; UP	<b>9 PK 1780 TM</b>
				W-P	FROM MTR-NO: 002988; OE-NO.: 0019932796; MOD: 1835LS;1840LS;SA53273606	<b>9 PK 2140 TM</b>
				W-P	FROM MTR-NO: 002988; OE-NO.: 0149976092; MOD: 1835LS;1840LS;SA52205617	<b>9 PK 2100 TM</b>
				W-P	FROM MTR-NO: 002988; OE-NO.: 0149976092; MOD: 1835LS;1840LS;SA53273603	<b>9 PK 2100 TM</b>
				W-P	FROM MTR-NO: 002988; OE-NO.: 0149976892; MOD: 1835LS;1840LS;SA52205622	<b>9 PK 2295 TM</b>
				W-P	OE-NO.: 0149976892; MOD: 1835LS;1840LS;SA53273604	<b>9 PK 2295 TM</b>
				W-P	OE-NO.: 0159971792; MOD: 1835LS;1840LS	<b>9 PK 2010 TM</b>
				W-P	UNTIL MTR-NO: 002987; OE-NO.: 0139976192; MOD: 1835LS;1840LS;SA52205617	<b>9 PK 2060 TM</b>



## MERCEDES-BENZ

### AXOR

#### 2523

6374 ccm	170 kW	OM 906.920	01.02 - 10.04	ALT	OE-NO.: 9069933996; MOD: 2523;2523K;SA50503177	8 PK 1365 TM
				ALT	OE-NO.: 9069934096; MOD: 2523;2523K;SA50503178	8 PK 1940 TM
				ALT	OE-NO.: 9069970792; MOD: 2523;2523K;SA50503102	8 PK 1480 TM
				ALT	OE-NO.: 9069970992; MOD: 2523;2523K;SA50503107	8 PK 2605 TM
				ALT	OE-NO.: 9069971192; MOD: 2523;2523K;SA50507905	8 PK 2080 TM
				ALT	OE-NO.: 9069971292; MOD: 2523;2523K;SA50503106	8 PK 2000 TM
				ALT	OE-NO.: 9069972392; MOD: 2523;2523K;SA50503105	8 PK 2045 TM
				ALT	OE-NO.: 9069972492; MOD: 2523;2523K;SA50503103	8 PK 1420 TM
				ALT	OE-NO.: 9069973592; MOD: 2523;2523K;SA50503121	8 PK 1940 TM
				ALT	OE-NO.: 9069973692; MOD: 2523;2523K;SA50503122	8 PK 2560 TM
				FAN	OE-NO.: 9069932896; MOD: 2523;2523K;SA50503156	10 PK 1240 TM
				FAN	OE-NO.: 9069973392; MOD: 2523;2523K;SA50503116	10 PK 1240 TM
				HYD-P	OE-NO.: 9069934496; MOD: 2523;2523K;SA50503196	8 PK 1175 TM
				HYD-P	OE-NO.: 9069971392; MOD: 2523;2523K;SA505031/25	8 PK 1190 TM
				HYD-P	OE-NO.: 9069971392; MOD: 2523;2523K;SA505065/03	8 PK 1190 TM

#### 2528

6374 ccm	205 kW	OM 906.921	01.02 - 10.04	ALT	OE-NO.: 9069933996; MOD: 2528;SA50503177	8 PK 1365 TM
				ALT	OE-NO.: 9069934096; MOD: 2528;SA50503178	8 PK 1940 TM
				ALT	OE-NO.: 9069970792; MOD: 2528;SA50503102	8 PK 1480 TM
				ALT	OE-NO.: 9069970992; MOD: 2528;SA50503107	8 PK 2605 TM
				ALT	OE-NO.: 9069971192; MOD: 2528;SA50507905	8 PK 2080 TM
				ALT	OE-NO.: 9069971292; MOD: 2528;SA50503106	8 PK 2000 TM
				ALT	OE-NO.: 9069972392; MOD: 2528;SA50503105	8 PK 2045 TM
				ALT	OE-NO.: 9069972492; MOD: 2528;SA50503103	8 PK 1420 TM
				ALT	OE-NO.: 9069973592; MOD: 2528;SA50503121	8 PK 1940 TM
				ALT	OE-NO.: 9069973692; MOD: 2528;SA50503122	8 PK 2560 TM
				FAN	OE-NO.: 9069932896; MOD: 2528;SA50503156	10 PK 1240 TM
				FAN	OE-NO.: 9069973392; MOD: 2528;SA50503116	10 PK 1240 TM
				HYD-P	OE-NO.: 9069934496; MOD: 2528;SA50503196	8 PK 1175 TM
				HYD-P	OE-NO.: 9069971392; MOD: 2528;SA505031/25	8 PK 1190 TM
				HYD-P	OE-NO.: 9069971392; MOD: 2528;SA505065/03	8 PK 1190 TM

#### 2623

6374 ccm	170 kW	OM 906.920	01.02 - 10.04	ALT	OE-NO.: 9069933996; MOD: 2623L;SA50503177	8 PK 1365 TM
				ALT	OE-NO.: 9069934096; MOD: 2623L;SA50503178	8 PK 1940 TM
				ALT	OE-NO.: 9069970792; MOD: 2623L;SA50503102	8 PK 1480 TM
				ALT	OE-NO.: 9069970992; MOD: 2623L;SA50503107	8 PK 2605 TM
				ALT	OE-NO.: 9069971192; MOD: 2623L;SA50507905	8 PK 2080 TM
				ALT	OE-NO.: 9069971292; MOD: 2623L;SA50503106	8 PK 2000 TM
				ALT	OE-NO.: 9069972392; MOD: 2623L;SA50503105	8 PK 2045 TM
				ALT	OE-NO.: 9069972492; MOD: 2623L;SA50503103	8 PK 1420 TM
				ALT	OE-NO.: 9069973592; MOD: 2623L;SA50503121	8 PK 1940 TM
				ALT	OE-NO.: 9069973692; MOD: 2623L;SA50503122	8 PK 2560 TM
				FAN	OE-NO.: 9069932896; MOD: 2623L;SA50503156	10 PK 1240 TM
				FAN	OE-NO.: 9069973392; MOD: 2623L;SA50503116	10 PK 1240 TM
				HYD-P	OE-NO.: 9069934496; MOD: 2623L;SA50503196	8 PK 1175 TM
				HYD-P	OE-NO.: 9069971392; MOD: 2623L;SA505031/25	8 PK 1190 TM
				HYD-P	OE-NO.: 9069971392; MOD: 2623L;SA505065/03	8 PK 1190 TM

#### 2628

6374 ccm	205 kW	OM 906.921	01.02 - 10.04	ALT	OE-NO.: 9069933996; MOD: 2628B;2628K;2628L;SA50503177	8 PK 1365 TM
				ALT	OE-NO.: 9069934096; MOD: 2628B;2628K;2628L;SA50503178	8 PK 1940 TM

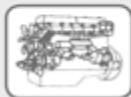

## MERCEDES-BENZ

### AXOR

#### 2628

6374 ccm	205 kW	OM 906.921	01.02 - 10.04	ALT	OE-NO.: 9069970792; MOD: 2628B;2628K;2628L;SA50503102	8 PK 1480 TM
				ALT	OE-NO.: 9069970992; MOD: 2628B;2628K;2628L;SA50503107	8 PK 2605 TM
				ALT	OE-NO.: 9069971192; MOD: 2628B;2628K;2628L;SA50507905	8 PK 2080 TM
				ALT	OE-NO.: 9069971292; MOD: 2628B;2628K;2628L;SA50503106	8 PK 2000 TM
				ALT	OE-NO.: 9069972392; MOD: 2628B;2628K;2628L;SA50503105	8 PK 2045 TM
				ALT	OE-NO.: 9069972492; MOD: 2628B;2628K;2628L;SA50503103	8 PK 1420 TM
				ALT	OE-NO.: 9069973592; MOD: 2628B;2628K;2628L;SA50503121	8 PK 1940 TM
				ALT	OE-NO.: 9069973692; MOD: 2628B;2628K;2628L;SA50503122	8 PK 2560 TM
				FAN	OE-NO.: 9069932896; MOD: 2628B;2628K;2628L;SA50503156	10 PK 1240 TM
				FAN	OE-NO.: 9069973392; MOD: 2628B;2628K;2628L;SA50503116	10 PK 1240 TM
				HYD-P	OE-NO.: 9069934496; MOD: 2628B;2628K;2628L;SA505031/96	8 PK 1175 TM
				HYD-P	OE-NO.: 9069971392; MOD: 2628B;2628K;2628L;SA505031/25	8 PK 1190 TM
				HYD-P	OE-NO.: 9069971392; MOD: 2628B;2628K;2628L;SA505065/03	8 PK 1190 TM

### CITARO (O 530)

#### Citaro.N

6374 ccm	170 kW	OM 906.931;OM 909.900;OM 909.911	01.98 -	ALT	MTR-CODE: OM906.931; OE-NO.: 0129972192; MOD: CitaroN;SA505031/11	11 PK 2055 TM
				ALT	MTR-CODE: OM906.931; OE-NO.: 0139972992; MOD: CitaroN;SA505031/09	10 PK 1845 TM
				ALT	MTR-CODE: OM906.931; OE-NO.: 9069974092; MOD: CitaroN;SA505031/27	10 PK 1620 TM
				ALT	MTR-CODE: OM909.900; OE-NO.: 0129972192; MOD: CitaroN;SA505031/11	11 PK 2055 TM
				ALT	MTR-CODE: OM909.900; OE-NO.: 0139972992; MOD: CitaroN;SA505031/09	10 PK 1845 TM
				ALT	MTR-CODE: OM909.900; OE-NO.: 9069974092; MOD: CitaroN;SA505031/27	10 PK 1620 TM
				ALT	MTR-CODE: OM909.900; OE-NO.: 9069974592; MOD: CitaroN;SA505031/28	10 PK 1400 TM
				ALT	MTR-CODE: OM909.900; OE-NO.: 9069974692; MOD: CitaroN;SA505031/29	10 PK 1670 TM
				ALT	MTR-CODE: OM909.900; OE-NO.: 9069974792; MOD: CitaroN;SA505031/30	10 PK 1815 TM
				ALT	MTR-CODE: OM909.911; OE-NO.: 9069970792; MOD: CitaroN;SA505031/02	8 PK 1480 TM
				ALT	MTR-CODE: OM909.911; OE-NO.: 9069971192; MOD: CitaroN;SA505031/04	8 PK 2080 TM
				ALT	MTR-CODE: OM909.911; OE-NO.: 9069971192; MOD: CitaroN;SA505079/05	8 PK 2080 TM
				ALT	MTR-CODE: OM909.911; OE-NO.: 9069972392; MOD: CitaroN;SA505031/05	8 PK 2045 TM
				ALT	MTR-CODE: OM909.911; OE-NO.: 9069972492; MOD: CitaroN;SA505031/03	8 PK 1420 TM
				ALT	MTR-CODE: OM909.911; OE-NO.: 9069972992; MOD: CitaroN;SA505031/09	8 PK 2523 TM
				ALT	MTR-CODE: OM909.911; OE-NO.: 9069973192; MOD: CitaroN;SA505031/17	8 PK 1850 TM
				ALT	MTR-CODE: OM909.911; OE-NO.: 9069973692; MOD: CitaroN;SA505031/22	8 PK 2560 TM
				ALT	MTR-CODE: OM909.911; OE-NO.: 9069973892; MOD: CitaroN;SA505031/23	10 PK 2240 TM
				ALT	MTR-CODE: OM909.911; OE-NO.: 9069974192; MOD: CitaroN;SA505031/26	8 PK 1515 TM
				ALT	MTR-CODE: OM909.911; OE-NO.: 9069974592; MOD: CitaroN;SA505031/28	10 PK 1400 TM
				ALT	OE-NO.: 9069934196; MOD: CitaroN;SA505031/83	8 PK 1915 TM
				ALT	OE-NO.: 9069972892; MOD: CitaroN;SA505031/08	8 PK 1915 TM

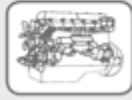

## MERCEDES-BENZ

### CITARO (O 530)

#### Citaro.N

6374 ccm	170 kW	OM 906.931;OM 909.900;OM 909.911	01.98 -	ALT	OE-NO.: 9069972892; MOD: CitaroN;SA505031/08/83	8 PK 1915 TM
				FAN	MTR-CODE: OM906.931; OE-NO.: 9069972692; MOD: CitaroN;SA505031/10	10 PK 1350 TM
				FAN	MTR-CODE: OM909.900; OE-NO.: 9069972692; MOD: CitaroN;SA505031/10	10 PK 1350 TM
	205 kW	OM 906.930;OM 906.960;OM 906.961;OM 909.901;OM 909.921		ALT	FROM: 11.01; MTR-CODE: OM457.942; OE-NO.: 0129976392; MOD: CONECTO;SA522056/05	11 PK 2040 TM
				ALT	FROM: 11.01; MTR-CODE: OM457.942; OE-NO.: 0139972992; MOD: CONECTO;SA522056/13	10 PK 1845 TM
				ALT	FROM: 11.01; MTR-CODE: OM457.942; OE-NO.: 0139973092; MOD: CONECTO	11 PK 2020 TM
				ALT	FROM: 11.01; MTR-CODE: OM457.942; OE-NO.: 0139973192; MOD: CONECTO;SA522056/15	10 PK 1860 TM
				ALT	MTR-CODE: OM457.942; OE-NO.: 0129976392; MOD: CitaroN;SA522056/05	11 PK 2040 TM
				ALT	MTR-CODE: OM457.942; OE-NO.: 0139972992; MOD: CitaroN;SA522056/13	10 PK 1845 TM
				ALT	MTR-CODE: OM457.942; OE-NO.: 0139973092; MOD: CitaroN	11 PK 2020 TM
				ALT	MTR-CODE: OM457.942; OE-NO.: 0139973192; MOD: CitaroN;SA522056/15	10 PK 1860 TM
				ALT	MTR-CODE: OM906.930; OE-NO.: 9069972192; MOD: CitaroN;SA505031/11	10 PK 1768 TM
				ALT	MTR-CODE: OM906.930; OE-NO.: 9069972992; MOD: CitaroN;SA505031/09	8 PK 2523 TM
				ALT	MTR-CODE: OM906.930; OE-NO.: 9069974092; MOD: CitaroN;SA505031/27	10 PK 1620 TM
				ALT	MTR-CODE: OM906.960; OE-NO.: 9069972992; MOD: CitaroN;SA505031/09	8 PK 2523 TM
				ALT	MTR-CODE: OM906.960; OE-NO.: 9069974092; MOD: CitaroN;SA505031/27	10 PK 1620 TM
				ALT	MTR-CODE: OM906.960; OE-NO.: 9069974592; MOD: CitaroN;SA505031/28	10 PK 1400 TM
				ALT	MTR-CODE: OM906.960; OE-NO.: 9069974692; MOD: CitaroN;SA505031/29	10 PK 1670 TM
				ALT	MTR-CODE: OM906.960; OE-NO.: 9069974792; MOD: CitaroN;SA505031/30	10 PK 1815 TM
				ALT	MTR-CODE: OM906.961; OE-NO.: 9069933996; MOD: CitaroN;SA505031/77	8 PK 1365 TM
				ALT	MTR-CODE: OM906.961; OE-NO.: 9069934096; MOD: CitaroN;SA505031/78	8 PK 1940 TM
				ALT	MTR-CODE: OM906.961; OE-NO.: 9069972392; MOD: CitaroN;SA505031/05	8 PK 2045 TM
				ALT	MTR-CODE: OM906.961; OE-NO.: 9069972492; MOD: CitaroN;SA505031/03	8 PK 1420 TM
				ALT	MTR-CODE: OM906.961; OE-NO.: 9069973192; MOD: CitaroN;SA505031/17	8 PK 1850 TM
				ALT	MTR-CODE: OM906.961; OE-NO.: 9069973892; MOD: CitaroN;SA505031/23	10 PK 2240 TM
				ALT	MTR-CODE: OM906.961; OE-NO.: 9069974192; MOD: CitaroN;SA505031/26	8 PK 1515 TM
				ALT	MTR-CODE: OM906.961; OE-NO.: 9069974592; MOD: CitaroN;SA505031/28	10 PK 1400 TM
				ALT	MTR-CODE: OM909.901; OE-NO.: 9069972192; MOD: CitaroN;SA505031/11	10 PK 1768 TM
				ALT	MTR-CODE: OM909.901; OE-NO.: 9069972992; MOD: CitaroN;SA505031/09	8 PK 2523 TM
				ALT	MTR-CODE: OM909.901; OE-NO.: 9069974092; MOD: CitaroN;SA505031/27	10 PK 1620 TM
				ALT	MTR-CODE: OM909.901; OE-NO.: 9069974592; MOD: CitaroN;SA505031/28	10 PK 1400 TM
				ALT	MTR-CODE: OM909.901; OE-NO.: 9069974692; MOD: CitaroN;SA505031/29	10 PK 1670 TM
				ALT	MTR-CODE: OM909.901; OE-NO.: 9069974792; MOD: CitaroN;SA505031/30	10 PK 1815 TM
				ALT	MTR-CODE: OM909.921; OE-NO.: 9069970792; MOD: CitaroN;SA505031/02	8 PK 1480 TM
				ALT	MTR-CODE: OM909.921; OE-NO.: 9069971192; MOD: CitaroN;SA505031/04	8 PK 2080 TM
				ALT	MTR-CODE: OM909.921; OE-NO.: 9069971192; MOD: CitaroN;SA505079/05	8 PK 2080 TM



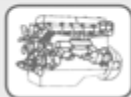

## MERCEDES-BENZ

### CITARO (O 530)

#### Citaro.N

6374 ccm	205 kW	OM 906.930;OM 906.960;OM 906.961;OM 909.901;OM 909.921	01.98 -	ALT	MTR-CODE: OM909.921; OE-NO.: 9069972392; MOD: CitaroN;SA505031/05	<b>8 PK 2045 TM</b>
				ALT	MTR-CODE: OM909.921; OE-NO.: 9069972492; MOD: CitaroN;SA505031/03	<b>8 PK 1420 TM</b>
				ALT	MTR-CODE: OM909.921; OE-NO.: 9069972992; MOD: CitaroN;SA505031/09	<b>8 PK 2523 TM</b>
				ALT	MTR-CODE: OM909.921; OE-NO.: 9069973192; MOD: CitaroN;SA505031/17	<b>8 PK 1850 TM</b>
				ALT	MTR-CODE: OM909.921; OE-NO.: 9069973692; MOD: CitaroN;SA505031/22	<b>8 PK 2560 TM</b>
				ALT	MTR-CODE: OM909.921; OE-NO.: 9069973892; MOD: CitaroN;SA505031/23	<b>10 PK 2240 TM</b>
				ALT	MTR-CODE: OM909.921; OE-NO.: 9069974592; MOD: CitaroN;SA505031/28	<b>10 PK 1400 TM</b>
				ALT	OE-NO.: 9069934196; MOD: CitaroN;SA505031/83	<b>8 PK 1915 TM</b>
				ALT	OE-NO.: 9069972892; MOD: CitaroN;SA505031/08	<b>8 PK 1915 TM</b>
				FAN	FROM: 11.01; MTR-CODE: OM457.942; OE-NO.: 0129976092; MOD: CONECTO	<b>9 PK 1725 TM</b>
				FAN	MTR-CODE: OM457.942; OE-NO.: 0129976092; MOD: CitaroN	<b>9 PK 1725 TM</b>
				FAN	MTR-CODE: OM906.930; OE-NO.: 9069972692; MOD: CitaroN;SA505031/10	<b>10 PK 1350 TM</b>
				FAN	MTR-CODE: OM909.901; OE-NO.: 9069972692; MOD: CitaroN;SA505031/10	<b>10 PK 1350 TM</b>
				FAN	MTR-CODE: OM909.921; OE-NO.: 9069972692; MOD: CitaroN;SA505031/10	<b>10 PK 1350 TM</b>
				HYD-P	MTR-CODE: OM909.921; OE-NO.: 9069974192; MOD: CitaroN;SA505031/26	<b>8 PK 1515 TM</b>
				W-P	FROM: 11.01; MTR-CODE: OM457.942; OE-NO.: 0129972092; MOD: CONECTO;SA522056/02	<b>9 PK 2125 TM</b>
				W-P	MTR-CODE: OM457.942; OE-NO.: 0129972092; MOD: CitaroN;SA522056/02	<b>9 PK 2125 TM</b>

### LK/LN2

#### 1114

5958 ccm	95-100 kW	OM 356.903;OM 366.918;OM 366.931	01.84 - 12.98	AIR-C	MTR-CODE: OM 356.903; MOD: 1114 AK;1114 K; REQ: 2	<b>AVX 13 x 1025 TM</b>
				ALT	MTR-CODE: OM 356;OM 356.903; MOD: 1114 AK;1114 K; REQ: 2	<b>AVX 13 x 1375 TM</b>
				ALT	UNTIL MTR-NO: 937628; MTR-CODE: OM 356.903; MOD: 1114 AK;1114 K; REQ: 2; - MTR-CODE: OM 356	<b>AVX 13 x 1325 TM</b>
				HYD-P	FROM MTR-NO: 937629; MTR-CODE: OM 356.903; MOD: 1114 AK;1114 K; REQ: 2; - MTR-CODE: OM 356	<b>AVX 13 x 1375 TM</b>
				PS	MTR-CODE: OM 356.903; MOD: 1114 AK;1114 K	<b>AVX 13 x 925 TM</b>
		OM 356.904;OM 366.907;OM 366.914		AIR-C	MTR-CODE: OM 356.903; MOD: 1114 AK;1114 K; REQ: 2	<b>AVX 13 x 1025 TM</b>
				ALT	MTR-CODE: OM 356;OM 356.903; MOD: 1114 AK;1114 K; REQ: 2	<b>AVX 13 x 1375 TM</b>
				ALT	UNTIL MTR-NO: 937628; MTR-CODE: OM 356.903; MOD: 1114 AK;1114 K; REQ: 2; - MTR-CODE: OM 356	<b>AVX 13 x 1325 TM</b>
				HYD-P	FROM MTR-NO: 937629; MTR-CODE: OM 356.903; MOD: 1114 AK;1114 K; REQ: 2; - MTR-CODE: OM 356	<b>AVX 13 x 1375 TM</b>
				PS	MTR-CODE: OM 356.903; MOD: 1114 AK;1114 K	<b>AVX 13 x 925 TM</b>
		OM 356.904;OM 366.907;OM 366.914;OM 366.930		AIR-C	MTR-CODE: OM 356.903; MOD: 1114 AK;1114 K; REQ: 2	<b>AVX 13 x 1025 TM</b>
				ALT	MTR-CODE: OM 356;OM 356.903; MOD: 1114 AK;1114 K; REQ: 2	<b>AVX 13 x 1375 TM</b>
				ALT	UNTIL MTR-NO: 937628; MTR-CODE: OM 356.903; MOD: 1114 AK;1114 K; REQ: 2; - MTR-CODE: OM 356	<b>AVX 13 x 1325 TM</b>
				HYD-P	FROM MTR-NO: 937629; MTR-CODE: OM 356.903; MOD: 1114 AK;1114 K; REQ: 2; - MTR-CODE: OM 356	<b>AVX 13 x 1375 TM</b>
				PS	MTR-CODE: OM 356.903; MOD: 1114 AK;1114 K	<b>AVX 13 x 925 TM</b>



## MERCEDES-BENZ

### LK/LN2

**1117**

5958 ccm	116-125 kW	OM 356.947;OM 356.959;OM 357.906;OM 366.966;OM 366.975;OM 366.976	01.84 - 12.98	AC-C	FROM MTR-NO: 937629; MTR-CODE: OM 356.947;OM 366.953; MOD: 1117 A;1117 K; REQ: 2	<b>AVX 13 x 1350 TM</b>
				AC-C	FROM MTR-NO: 937629; MTR-CODE: OM 356.947;OM 366.966; MOD: 1117 A;1117 K; REQ: 2	<b>AVX 13 x 1350 TM</b>
				AC-C	MTR-CODE: OM 356.947;OM 366.941; MOD: 1117 A;1117 K; REQ: 2	<b>AVX 13 x 1350 TM</b>
				AC-C	UNTIL MTR-NO: 937628; MTR-CODE: OM 356.947;OM 366.962; MOD: 1117 A;1117 K; REQ: 2	<b>AVX 13 x 1300 TM</b>
				AIR-C	MTR-CODE: OM 356.947; MOD: 1117 A;1117 K; REQ: 2	<b>AVX 13 x 1025 TM</b>
				ALT	MTR-CODE: BM357;OM 356.947; MOD: 1117 A;1117 K; REQ: 2	<b>AVX 13 x 1350 TM</b>
				ALT	UNTIL MTR-NO: 937628; MTR-CODE: OM 356.947;OM 366.953; MOD: 1117 A;1117 K; REQ: 2	<b>AVX 13 x 1300 TM</b>
				PS	MTR-CODE: OM 356.947; MOD: 1117 A;1117 K	<b>AVX 13 x 925 TM</b>
				AIR-C	MTR-CODE: OM 356.947;OM 357.901; MOD: LK/LN2;1117 A/1117 K; OE-NO.: 0139971692	<b>10 PK 1005 TM</b>
		OM 357.901;OM 357.918;OM 366.941;OM 366.953;OM 366.962		AC-C	FROM MTR-NO: 937629; MTR-CODE: OM 356.947;OM 366.953; MOD: 1117 A;1117 K; REQ: 2	<b>AVX 13 x 1350 TM</b>
				AC-C	FROM MTR-NO: 937629; MTR-CODE: OM 356.947;OM 366.966; MOD: 1117 A;1117 K; REQ: 2	<b>AVX 13 x 1350 TM</b>
				AC-C	MTR-CODE: OM 356.947;OM 366.941; MOD: 1117 A;1117 K; REQ: 2	<b>AVX 13 x 1350 TM</b>
				AC-C	UNTIL MTR-NO: 937628; MTR-CODE: OM 356.947;OM 366.962; MOD: 1117 A;1117 K; REQ: 2	<b>AVX 13 x 1300 TM</b>
				AIR-C	MTR-CODE: OM 356.947; MOD: 1117 A;1117 K; REQ: 2	<b>AVX 13 x 1025 TM</b>
				ALT	MTR-CODE: BM357;OM 356.947; MOD: 1117 A;1117 K; REQ: 2	<b>AVX 13 x 1350 TM</b>
				ALT	UNTIL MTR-NO: 937628; MTR-CODE: OM 356.947;OM 366.953; MOD: 1117 A;1117 K; REQ: 2	<b>AVX 13 x 1300 TM</b>
				PS	MTR-CODE: OM 356.947; MOD: 1117 A;1117 K	<b>AVX 13 x 925 TM</b>
				AIR-C	MTR-CODE: OM 356.947;OM 357.901; MOD: LK/LN2;1117A/1117K; OE-NO.: 0139971692	<b>10 PK 1005 TM</b>
		OM 357.901;OM 357.918;OM 366.941;OM 366.953;OM 366.962;OM 366.970		AC-C	FROM MTR-NO: 937629; MTR-CODE: OM 356.947;OM 366.953; MOD: 1117 A;1117 K; REQ: 2	<b>AVX 13 x 1350 TM</b>
				AC-C	FROM MTR-NO: 937629; MTR-CODE: OM 356.947;OM 366.966; MOD: 1117 A;1117 K; REQ: 2	<b>AVX 13 x 1350 TM</b>
				AC-C	MTR-CODE: OM 356.947;OM 366.941; MOD: 1117 A;1117 K; REQ: 2	<b>AVX 13 x 1350 TM</b>
				AC-C	UNTIL MTR-NO: 937628; MTR-CODE: OM 356.947;OM 366.962; MOD: 1117 A;1117 K; REQ: 2	<b>AVX 13 x 1300 TM</b>
				AIR-C	MTR-CODE: OM 356.947; MOD: 1117 A;1117 K; REQ: 2	<b>AVX 13 x 1025 TM</b>
				ALT	MTR-CODE: BM357;OM 356.947; MOD: 1117 A;1117 K; REQ: 2	<b>AVX 13 x 1350 TM</b>
				ALT	UNTIL MTR-NO: 937628; MTR-CODE: OM 356.947;OM 366.953; MOD: 1117 A;1117 K; REQ: 2	<b>AVX 13 x 1300 TM</b>
				PS	MTR-CODE: OM 356.947; MOD: 1117 A;1117 K	<b>AVX 13 x 925 TM</b>
				AIR-C	MTR-CODE: OM 356.947;OM 35.901; MOD: LK/LN2;1117 A,1117K; OE-NO.: 0139971692	<b>10 PK 1005 TM</b>
		OM 357.901;OM 366.941;OM 366.953;OM 366.962		AC-C	FROM MTR-NO: 937629; MTR-CODE: OM 356.947;OM 366.953; MOD: 1117 A;1117 K; REQ: 2	<b>AVX 13 x 1350 TM</b>
				AC-C	FROM MTR-NO: 937629; MTR-CODE: OM 356.947;OM 366.966; MOD: 1117 A;1117 K; REQ: 2	<b>AVX 13 x 1350 TM</b>
				AC-C	MTR-CODE: OM 356.947;OM 366.941; MOD: 1117 A;1117 K; REQ: 2	<b>AVX 13 x 1350 TM</b>
				AC-C	UNTIL MTR-NO: 937628; MTR-CODE: OM 356.947;OM 366.962; MOD: 1117 A;1117 K; REQ: 2	<b>AVX 13 x 1300 TM</b>
				AIR-C	MTR-CODE: OM 356.947; MOD: 1117 A;1117 K; REQ: 2	<b>AVX 13 x 1025 TM</b>



## MERCEDES-BENZ

### LK/LN2

#### 1117

5958 ccm	116-125 kW	OM 357.901;OM 366.941;OM 366.953;OM 366.962	01.84 - 12.98	ALT	MTR-CODE: BM357;OM 356.947; MOD: 1117 A;1117 K; REQ: 2	<b>AVX 13 x 1350 TM</b>
				ALT	UNTIL MTR-NO: 937628; MTR-CODE: OM 356.947;OM 366.953; MOD: 1117 A;1117 K; REQ: 2	<b>AVX 13 x 1300 TM</b>
	125 kW	OM 357.902;OM 357.906;OM 357.907		PS	MTR-CODE: OM 356.947; MOD: 1117 A;1117 K	<b>AVX 13 x 925 TM</b>
				AIR-C	MTR-CODE: OM 356.947;OM 357.901; MOD: LK/N2;1117 A/1117 K; OE-NO.: 0139971692	<b>10 PK 1005 TM</b>
4249 ccm		OM 904.907		AIR-C	MTR-CODE: OM 357.902; MOD: 1117 AK; REQ: 2	<b>AVX 13 x 1025 TM</b>
				ALT	MTR-CODE: OM 357.902; MOD: 1117 AK; REQ: 2	<b>AVX 13 x 1350 TM</b>
				PS	MTR-CODE: OM 357.902; MOD: 1117 AK	<b>AVX 13 x 925 TM</b>
				ALT	OE-NO.: 9069933996; MOD: 1117K;1117S;SA505031/77	<b>8 PK 1365 TM</b>
				ALT	OE-NO.: 9069934096; MOD: 1117K;1117S;SA505031/78	<b>8 PK 1940 TM</b>
				ALT	OE-NO.: 9069970792; MOD: 1117K;1117S;SA505031/02	<b>8 PK 1480 TM</b>
				ALT	OE-NO.: 9069971292; MOD: 1117K;1117S;SA505031/06	<b>8 PK 2000 TM</b>
				ALT	OE-NO.: 9069973092; MOD: 1117K;1117S;SA599023/01	<b>8 PK 1230 TM</b>
			HYD-P	MOD: 1117K;1117S	<b>8 PK 1175 TM</b>	

#### 1120

5958 ccm	125 kW	OM 366.962	01.84 - 12.98	AIR-C	OE-NO.: 0099976992; MOD: 1120 L; REQ: 2	<b>AVX 13 x 1025 TM</b>				
				ALT	FROM MTR-NO: 937629; MOD: 1120 L; REQ: 2	<b>AVX 13 x 1350 TM</b>				
	148-155 kW	OM 356.986;OM 356.992;OM 357.920;OM 357.927;OM 357.932;OM 366.988		ALT	UNTIL MTR-NO: 937628; MOD: 1120 L; REQ: 2	<b>AVX 13 x 1300 TM</b>				
				AC-C	FROM MTR-NO: 937629; MTR-CODE: OM 356.986;OM366988; MOD: 1120 S;1120 LS; REQ: 2	<b>AVX 13 x 1350 TM</b>				
				AIR-C	MTR-CODE: OM 356.986; OE-NO.: 0099976992; MOD: 1120 S;1120 LS; REQ: 2	<b>AVX 13 x 1025 TM</b>				
				ALT	MTR-CODE: BM356; BM357;OM 356.986; MOD: 1120 S;1120 LS; REQ: 2	<b>AVX 13 x 1350 TM</b>				
				ALT	UNTIL MTR-NO: 937628; MTR-CODE: OM 356.986;OM366988; MOD: 1120 S;1120 LS; REQ: 2	<b>AVX 13 x 1300 TM</b>				
				PS	MTR-CODE: OM 356.986; MOD: 1120 S;1120 LS	<b>AVX 13 x 925 TM</b>				
				AIR-C	MTR-CODE: OM 356.986; MOD: LK/LN2;1120 S;1120 LS; OE-NO.: 0139971692	<b>10 PK 1005 TM</b>				
				AC-C	FROM MTR-NO: 937629; MTR-CODE: OM 356.986;OM366988; MOD: 1120 S;1120 LS; REQ: 2	<b>AVX 13 x 1350 TM</b>				
				AIR-C	MTR-CODE: OM 356.986; OE-NO.: 0099976992; MOD: 1120 S;1120 LS; REQ: 2	<b>AVX 13 x 1025 TM</b>				
				ALT	MTR-CODE: BM356; BM357;OM 356.986; MOD: 1120 S;1120 LS; REQ: 2	<b>AVX 13 x 1350 TM</b>				
				ALT	UNTIL MTR-NO: 937628; MTR-CODE: OM 356.986;OM366988; MOD: 1120 S;1120 LS; REQ: 2	<b>AVX 13 x 1300 TM</b>				
				PS	MTR-CODE: OM 356.986; MOD: 1120 S;1120 LS	<b>AVX 13 x 925 TM</b>				
				AIR-C	MTR-CODE: OM 356.986; MOD: LK/LN2;1120 S;1120 LS; OE-NO.: 0139971692	<b>10 PK 1005 TM</b>				
				150-155 kW	OM 356.994;OM 356.995;OM 366.992;OM 366.994			AC-C	FROM MTR-NO: 937629; MTR-CODE: OM 356.994;OM366992; MOD: 1120 AF;1120 F; REQ: 2	<b>AVX 13 x 1350 TM</b>
								AC-C	UNTIL MTR-NO: 937628; MTR-CODE: OM 356.994;OM366994; MOD: 1120 AF;1120 F; REQ: 2	<b>AVX 13 x 1300 TM</b>
								AIR-C	MTR-CODE: OM 356.994; OE-NO.: 0099976992; MOD: 1120 AF;1120 F; REQ: 2	<b>AVX 13 x 1025 TM</b>
ALT	MTR-CODE: BM356; BM357;OM 356.994; MOD: 1120 AF;1120 F; REQ: 2	<b>AVX 13 x 1350 TM</b>								
ALT	UNTIL MTR-NO: 937628; MTR-CODE: OM 356.994;OM366992; MOD: 1120 AF;1120 F; REQ: 2	<b>AVX 13 x 1300 TM</b>								
PS	MTR-CODE: OM 356.994; MOD: 1120 AF;1120 F	<b>AVX 13 x 925 TM</b>								
AIR-C	MTR-CODE: OM 356.994; MOD: LK/LN2;1120 AF;1120 F; OE-NO.: 0139971692	<b>10 PK 1005 TM</b>								
AC-C	FROM MTR-NO: 937629; MTR-CODE: OM 356.994;OM366992; MOD: 1120 AF;1120 F; REQ: 2	<b>AVX 13 x 1350 TM</b>								

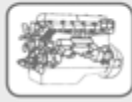

## MERCEDES-BENZ

### LK/LN2

#### 1120

5958 ccm	150-155 kW	OM 356.996;OM 366.992	01.84 - 12.98	AC-C	UNTIL MTR-NO: 937628; MTR-CODE: OM 356.994;OM366994; MOD: 1120 AF;1120 F; REQ: 2	<b>AVX 13 x 1300 TM</b>
				AIR-C	MTR-CODE: OM 356.994; OE-NO.: 0099976992; MOD: 1120 AF;1120 F; REQ: 2	<b>AVX 13 x 1025 TM</b>
				ALT	MTR-CODE: BM356; BM357;OM 356.994; MOD: 1120 AF;1120 F; REQ: 2	<b>AVX 13 x 1350 TM</b>
				ALT	UNTIL MTR-NO: 937628; MTR-CODE: OM 356.994;OM366992; MOD: 1120 AF;1120 F; REQ: 2	<b>AVX 13 x 1300 TM</b>
				PS	MTR-CODE: OM 356.994; MOD: 1120 AF;1120 F	<b>AVX 13 x 925 TM</b>
				AIR-C	MTR-CODE: OM 356.994; MOD: LK/LN2;1120 AF/1120F; OE-NO.: 0139971692	<b>10 PK 1005 TM</b>

#### 1124

5958 ccm	155-177 kW	OM 356.979;OM 356.983;OM 357.933;OM 357.942	03.92 - 12.98	AIR-C	MTR-CODE: OM 356.979; MOD: 1124 AF;1124 F; REQ: 2	<b>AVX 13 x 1025 TM</b>
				ALT	MTR-CODE: OM 356.979; MOD: 1124 AF;1124 F; REQ: 2	<b>AVX 13 x 1350 TM</b>
	177 kW	OM 356.983;OM 356.989;OM 356.991;OM 357.943;OM 357.944		PS	MTR-CODE: OM 356.979; MOD: 1124 AF;1124 F	<b>AVX 13 x 925 TM</b>
				AIR-C	MTR-CODE: OM 356.979; MOD: 1124 AF;1124 F; REQ: 2	<b>AVX 13 x 1025 TM</b>
				ALT	MTR-CODE: OM 356.979; MOD: 1124 AF;1124 F; REQ: 2	<b>AVX 13 x 1350 TM</b>
				PS	MTR-CODE: OM 356.979; MOD: 1124 AF;1124 F	<b>AVX 13 x 925 TM</b>

#### 1217

5958 ccm	125 kW	OM 357.901;OM 357.918	03.94 - 12.98	AIR-C	MTR-CODE: OM 357.901; MOD: 1217 KO; REQ: 2	<b>AVX 13 x 1025 TM</b>
				ALT	MTR-CODE: OM 357.901; MOD: 1217 KO; REQ: 2	<b>AVX 13 x 1350 TM</b>
				PS	MTR-CODE: OM 357.901; MOD: 1217 KO	<b>AVX 13 x 925 TM</b>

#### 1314

5958 ccm	95-100 kW	OM 356.908;OM 366.936	07.84 - 12.98	AIR-C	MTR-CODE: OM 356.908; MOD: 1314;1314 AK;1314 K; REQ: 2	<b>AVX 13 x 1025 TM</b>
				ALT	MTR-CODE: OM 356;OM 356.908; MOD: 1314;1314 AK;1314 K; REQ: 2	<b>AVX 13 x 1375 TM</b>
				ALT	UNTIL MTR-NO: 937628; MTR-CODE: OM 356.908; MOD: 1314;1314 AK;1314 K; REQ: 2; - MTR-CODE: OM 356	<b>AVX 13 x 1325 TM</b>
				HYD-P	FROM MTR-NO: 937629; MTR-CODE: OM 356.908; MOD: 1314;1314 AK;1314 K; REQ: 2; - MTR-CODE: OM 356	<b>AVX 13 x 1375 TM</b>
				PS	MTR-CODE: OM 356.908; MOD: 1314;1314 AK;1314 K	<b>AVX 13 x 925 TM</b>
		OM 356.909;OM 366.907;OM 366.914		AIR-C	MTR-CODE: OM 356.908; MOD: 1314;1314 AK;1314 K; REQ: 2	<b>AVX 13 x 1025 TM</b>
				ALT	MTR-CODE: OM 356;OM 356.908; MOD: 1314;1314 AK;1314 K; REQ: 2	<b>AVX 13 x 1375 TM</b>
				ALT	UNTIL MTR-NO: 937628; MTR-CODE: OM 356.908; MOD: 1314;1314 AK;1314 K; REQ: 2; - MTR-CODE: OM 356	<b>AVX 13 x 1325 TM</b>
				HYD-P	FROM MTR-NO: 937629; MTR-CODE: OM 356.908; MOD: 1314;1314 AK;1314 K; REQ: 2; - MTR-CODE: OM 356	<b>AVX 13 x 1375 TM</b>
				PS	MTR-CODE: OM 356.908; MOD: 1314;1314 AK;1314 K	<b>AVX 13 x 925 TM</b>
		OM 356.909;OM 366.918;OM 366.937		AIR-C	MTR-CODE: OM 356.908; MOD: 1314;1314 AK;1314 K; REQ: 2	<b>AVX 13 x 1025 TM</b>
				ALT	MTR-CODE: OM 356;OM 356.908; MOD: 1314;1314 AK;1314 K; REQ: 2	<b>AVX 13 x 1375 TM</b>
				ALT	UNTIL MTR-NO: 937628; MTR-CODE: OM 356.908; MOD: 1314;1314 AK;1314 K; REQ: 2; - MTR-CODE: OM 356	<b>AVX 13 x 1325 TM</b>
				HYD-P	FROM MTR-NO: 937629; MTR-CODE: OM 356.908; MOD: 1314;1314 AK;1314 K; REQ: 2; - MTR-CODE: OM 356	<b>AVX 13 x 1375 TM</b>
				PS	MTR-CODE: OM 356.908; MOD: 1314;1314 AK;1314 K	<b>AVX 13 x 925 TM</b>
		OM 356.910;OM 366.907;OM 366.914		AIR-C	MTR-CODE: OM 356.908; MOD: 1314;1314 AK;1314 K; REQ: 2	<b>AVX 13 x 1025 TM</b>
				ALT	MTR-CODE: OM 356;OM 356.908; MOD: 1314;1314 AK;1314 K; REQ: 2	<b>AVX 13 x 1375 TM</b>

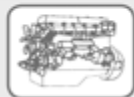

## MERCEDES-BENZ

### LK/LN2

#### 1314

5958 ccm	95-100 kW	OM 356.910;OM 366.907;OM 366.914	07.84 - 12.98	ALT	UNTIL MTR-NO: 937628; MTR-CODE: OM 356.908; MOD: 1314;1314 AK;1314 K; REQ: 2; - MTR-CODE: OM 356	AVX 13 x 1325 TM
				HYD-P	FROM MTR-NO: 937629; MTR-CODE: OM 356.908; MOD: 1314;1314 AK;1314 K; REQ: 2; - MTR-CODE: OM 356	AVX 13 x 1375 TM
				PS	MTR-CODE: OM 356.908; MOD: 1314;1314 AK;1314 K	AVX 13 x 925 TM

#### 1317

5958 ccm	116-125 kW	OM 356.944;OM 357.902;OM 357.961;OM 366.946;OM 366.953;OM 366.962	01.84 - 12.98	AC-C	FROM MTR-NO: 937629; MTR-CODE: OM 356.944;OM 366.953; MOD: 1317 AK; REQ: 2	AVX 13 x 1350 TM
				AC-C	FROM MTR-NO: 937629; MTR-CODE: OM 356.944;OM 366.962; MOD: 1317 AK; REQ: 2	AVX 13 x 1350 TM
				AC-C	MTR-CODE: OM 356.944;OM 366.946; MOD: 1317 AK; REQ: 2	AVX 13 x 1350 TM
				AC-C	UNTIL MTR-NO: 937628; MTR-CODE: OM 356.944;OM 366.962; MOD: 1317 AK; REQ: 2	AVX 13 x 1300 TM
				AIR-C	MTR-CODE: OM 356.944; MOD: 1317 AK; REQ: 2	AVX 13 x 1025 TM
				ALT	MTR-CODE: BM356; BM357;OM 356.944; MOD: 1317 AK; REQ: 2	AVX 13 x 1350 TM
				ALT	UNTIL MTR-NO: 937628; MTR-CODE: OM 356.944;OM 366.953; MOD: 1317 AK; REQ: 2	AVX 13 x 1300 TM
				PS	MTR-CODE: OM 356.944; MOD: 1317 AK	AVX 13 x 925 TM
		OM 356.944;OM 357.903;OM 357.962		AC-C	FROM MTR-NO: 937629; MTR-CODE: OM 357.902;OM 366.962; MOD: 1317 K;1317 KO; REQ: 2	AVX 13 x 1350 TM
				AIR-C	MTR-CODE: OM 357.902; MOD: 1317 K;1317 KO; REQ: 2	AVX 13 x 1025 TM
				ALT	MTR-CODE: BM357;OM 357.902; MOD: 1317 K;1317 KO; REQ: 2	AVX 13 x 1350 TM
				ALT	UNTIL MTR-NO: 937628; MTR-CODE: OM 357.902;OM 366.962; MOD: 1317 K;1317 KO; REQ: 2	AVX 13 x 1300 TM
				PS	MTR-CODE: OM 357.902; MOD: 1317 K;1317 KO	AVX 13 x 925 TM
		OM 356.945;OM 357.907;OM 366.944;OM 366.966		AC-C	FROM MTR-NO: 937629; MTR-CODE: OM 356.944;OM 366.953; MOD: 1317 AK; REQ: 2	AVX 13 x 1350 TM
				AC-C	FROM MTR-NO: 937629; MTR-CODE: OM 356.944;OM 366.962; MOD: 1317 AK; REQ: 2	AVX 13 x 1350 TM
				AC-C	MTR-CODE: OM 356.944;OM 366.946; MOD: 1317 AK; REQ: 2	AVX 13 x 1350 TM
				AC-C	UNTIL MTR-NO: 937628; MTR-CODE: OM 356.944;OM 366.962; MOD: 1317 AK; REQ: 2	AVX 13 x 1300 TM
				AIR-C	MTR-CODE: OM 356.944; MOD: 1317 AK; REQ: 2	AVX 13 x 1025 TM
				ALT	MTR-CODE: BM356; BM357;OM 356.944; MOD: 1317 AK; REQ: 2	AVX 13 x 1350 TM
				ALT	UNTIL MTR-NO: 937628; MTR-CODE: OM 356.944;OM 366.953; MOD: 1317 AK; REQ: 2	AVX 13 x 1300 TM
	125 kW	OM 357.902;OM 357.961;OM 366.962		PS	MTR-CODE: OM 356.944; MOD: 1317 AK	AVX 13 x 925 TM
				AC-C	FROM MTR-NO: 937629; MTR-CODE: OM 357.902;OM 366.962; MOD: 1317 K;1317 KO; REQ: 2	AVX 13 x 1350 TM
				AIR-C	MTR-CODE: OM 357.902; MOD: 1317 K;1317 KO; REQ: 2	AVX 13 x 1025 TM
				ALT	MTR-CODE: BM357;OM 357.902; MOD: 1317 K;1317 KO; REQ: 2	AVX 13 x 1350 TM
				ALT	UNTIL MTR-NO: 937628; MTR-CODE: OM 357.902;OM 366.962; MOD: 1317 K;1317 KO; REQ: 2	AVX 13 x 1300 TM
				PS	MTR-CODE: OM 357.902; MOD: 1317 K;1317 KO	AVX 13 x 925 TM
	155 kW	OM 356.995		AIR-C	MOD: 1317 AK; REQ: 2	AVX 13 x 1025 TM
				ALT	MOD: 1317 AK; REQ: 2	AVX 13 x 1350 TM
				PS	MOD: 1317 AK	AVX 13 x 925 TM

#### 1320

5958 ccm	125 kW	OM 366.962;OM 366.966	01.84 - 12.98	AC-C	FROM MTR-NO: 937629; MTR-CODE: OM 366.962;OM366966; MOD: 1320;1320 L; REQ: 2	AVX 13 x 1350 TM
				AC-C	UNTIL MTR-NO: 937628; MTR-CODE: OM 366.962;OM366966; MOD: 1320;1320 L; REQ: 2	AVX 13 x 1300 TM
				AIR-C	MTR-CODE: OM 366.962; OE-NO.: 0099976992; MOD: 1320;1320 L; REQ: 2	AVX 13 x 1025 TM

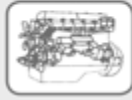

## MERCEDES-BENZ

### LK/LN2

#### 1320

5958 ccm	125 kW	OM 366.962;OM 366.966	01.84 - 12.98	ALT	FROM MTR-NO: 937629; MTR-CODE: OM 366.962;OM366962; MOD: 1320;1320 L; REQ: 2	AVX 13 x 1350 TM
				ALT	UNTIL MTR-NO: 937628; MTR-CODE: OM 366.962;OM366962; MOD: 1320;1320 L; REQ: 2	AVX 13 x 1300 TM
	148-155 kW	OM 356.992;OM 357.921;OM 357.932;OM 366.980;OM 366.988;OM 366.992;OM 366.997		AC-C	FROM MTR-NO: 937629; MTR-CODE: OM 356.992;OM366988; MOD: 1320 S;1320 LS; REQ: 2	AVX 13 x 1350 TM
				AC-C	FROM MTR-NO: 937629; MTR-CODE: OM 356.992;OM366992; MOD: 1320 S;1320 LS; REQ: 2	AVX 13 x 1350 TM
				AC-C	MTR-CODE: OM 356.992;OM366997; MOD: 1320 S;1320 LS; REQ: 2	AVX 13 x 1350 TM
				AC-C	UNTIL MTR-NO: 937628; MTR-CODE: OM 356.992;OM366988; MOD: 1320 S;1320 LS; REQ: 2	AVX 13 x 1300 TM
				AC-C	UNTIL MTR-NO: 937628; MTR-CODE: OM 356.992;OM366992; MOD: 1320 S;1320 LS	AVX 13 x 1300 TM
				AC-C	UNTIL MTR-NO: 937628; MTR-CODE: OM 356.992;OM366992; MOD: 1320 S;1320 LS; REQ: 2	AVX 13 x 1300 TM
				AIR-C	MTR-CODE: OM 356.992; OE-NO.: 0099976992; MOD: 1320 S;1320 LS; REQ: 2	AVX 13 x 1025 TM
				ALT	MTR-CODE: BM356; BM357;OM 356.992; MOD: 1320 S;1320 LS; REQ: 2	AVX 13 x 1350 TM
				ALT	MTR-CODE: OM 356.992;OM366980; MOD: 1320 S;1320 LS; REQ: 2	AVX 13 x 1300 TM
				PS	MTR-CODE: OM 356.992; MOD: 1320 S;1320 LS	AVX 13 x 925 TM
				AIR-C	MOD: LK/LN2;1320 S;1320 LS; OE-NO.: 0139971692; MTR-CODE: OM 356.992	10 PK 1005 TM
				AIR-C	MTR-CODE: OM 356.992; MOD: LK/LN2;1320 S;1320 LS; OE-NO.: 0139971692	10 PK 1005 TM
	177 kW	OM 356.983		AIR-C	OE-NO.: 0099976992; MOD: 1320 L; REQ: 2	AVX 13 x 1025 TM
				ALT	MOD: 1320 L; REQ: 2	AVX 13 x 1350 TM
				PS	MOD: 1320 L	AVX 13 x 925 TM

#### 1324

5958 ccm	150 kW	OM 366.997	01.84 - 12.98	AIR-C	MOD: 1324 L; REQ: 2	AVX 13 x 1025 TM
				ALT	MOD: 1324 L; REQ: 2	AVX 13 x 1350 TM
				PS	MOD: 1324 L	AVX 13 x 925 TM
	170-177 kW	OM 356.983;OM 357.940;OM 357.948;OM 366.999		AIR-C	MTR-CODE: OM 356.983;OM366999; MOD: 1324 S;1324 LS; REQ: 2	AVX 13 x 1025 TM
				ALT	MTR-CODE: OM 356.983;OM366999; MOD: 1324 S;1324 LS; REQ: 2	AVX 13 x 1350 TM
				PS	MTR-CODE: OM 356.983;OM366999; MOD: 1324 S;1324 LS	AVX 13 x 925 TM
				AIR-C	MOD: LK/LN2;1324 S;1324 LS; OE-NO.: 0139971692; MTR-CODE: OM 356.983	10 PK 1005 TM
				AIR-C	MTR-CODE: OM 356.983; MOD: LK/LN2;1324 S;1324 LS; OE-NO.: 0139971692	10 PK 1005 TM

#### 1514

5958 ccm	95-100 kW	OM 356.908;OM 366.936	01.84 - 12.98	AIR-C	MTR-CODE: OM 356.908; MOD: 1514 K;1514;1514 L; REQ: 2	AVX 13 x 1025 TM
				ALT	MTR-CODE: OM 356;OM 356.908; MOD: 1514 K;1514;1514 L; REQ: 2	AVX 13 x 1375 TM
				ALT	UNTIL MTR-NO: 937628; MTR-CODE: OM 356.908; MOD: 1514 K;1514;1514 L; REQ: 2; - MTR-CODE: OM 356	AVX 13 x 1325 TM
				HYD-P	FROM MTR-NO: 937629; MTR-CODE: OM 356.908; MOD: 1514 K;1514;1514 L; REQ: 2; - MTR-CODE: OM 356	AVX 13 x 1375 TM
				PS	MTR-CODE: OM 356.908; MOD: 1514 K;1514;1514 L	AVX 13 x 925 TM

#### 1517

5958 ccm	116-125 kW	OM 356.946;OM 356.953;OM 357.903;OM 357.962;OM 357.963;OM 366.945;OM 366.979	01.84 - 12.98	AC-C	MTR-CODE: OM 356.946;OM366945; MOD: 1517 K;1517;1517 L; REQ: 2	AVX 13 x 1350 TM
				AIR-C	MTR-CODE: OM 356.946; MOD: 1517 K;1517;1517 L; REQ: 2	AVX 13 x 1025 TM
				ALT	FROM MTR-NO: 937629; MTR-CODE: OM 356.946;OM366979; MOD: 1517 K;1517;1517 L; REQ: 2	AVX 13 x 1250 TM
				ALT	MTR-CODE: BM356; BM357;OM 356.946; MOD: 1517 K;1517;1517 L; REQ: 2	AVX 13 x 1350 TM

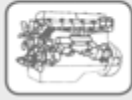

## MERCEDES-BENZ

### LK/LN2

#### 1517

5958 ccm	116-125 kW	OM 356.946;OM 356.953;OM 357.903;OM 357.962;OM 357.963;OM 366.945;OM 366.979	01.84 - 12.98	ALT	UNTIL MTR-NO: 937628; MTR-CODE: OM 356.946;OM366979; MOD: 1517 K;1517;1517 L; REQ: 2	AVX 13 x 1300 TM
				PS	MTR-CODE: OM 356.946; MOD: 1517 K;1517;1517 L	AVX 13 x 925 TM
		OM 356.946;OM 356.953;OM 357.903;OM 357.963;OM 366.945;OM 366.979		AC-C	MTR-CODE: OM 356.946;OM366945; MOD: 1517 K;1517;1517 L; REQ: 2	AVX 13 x 1350 TM
				AIR-C	MTR-CODE: OM 356.946; MOD: 1517 K;1517;1517 L; REQ: 2	AVX 13 x 1025 TM
				ALT	FROM MTR-NO: 937629; MTR-CODE: OM 356.946;OM366979; MOD: 1517 K;1517;1517 L; REQ: 2	AVX 13 x 1250 TM
				ALT	MTR-CODE: BM356; BM357;OM 356.946; MOD: 1517 K;1517;1517 L; REQ: 2	AVX 13 x 1350 TM
				ALT	UNTIL MTR-NO: 937628; MTR-CODE: OM 356.946;OM366979; MOD: 1517 K;1517;1517 L; REQ: 2	AVX 13 x 1300 TM
				PS	MTR-CODE: OM 356.946; MOD: 1517 K;1517;1517 L	AVX 13 x 925 TM

#### 1520

5958 ccm	150-155 kW	OM 356.990;OM 357.922;OM 357.930;OM 366.995	01.84 - 12.98	AC-C	FROM MTR-NO: 937629; MTR-CODE: OM 356.990;OM366995; MOD: 1520;1520 L; REQ: 2	AVX 13 x 1350 TM
				AIR-C	MTR-CODE: OM 356.990; OE-NO.: 0099976992; MOD: 1520;1520 L; REQ: 2	AVX 13 x 1025 TM
				ALT	MTR-CODE: BM356; BM357;OM 356.990; MOD: 1520;1520 L; REQ: 2	AVX 13 x 1350 TM
				ALT	UNTIL MTR-NO: 937628; MTR-CODE: OM 356.990;OM366995; MOD: 1520;1520 L; REQ: 2	AVX 13 x 1300 TM
				PS	MTR-CODE: OM 356.990; MOD: 1520;1520 L	AVX 13 x 925 TM
				AIR-C	MTR-CODE: OM 356.990; MOD: LK/LN2;1520;1520 L; OE-NO.: 0139971692	10 PK 1005 TM

#### 1524

5958 ccm	170-177 kW	OM 356.999;OM 357.941;OM 357.947;OM 366.999	01.84 - 12.98	AIR-C	MTR-CODE: OM 356.999;OM 366.999; MOD: 1524;1524 L; REQ: 2	AVX 13 x 1025 TM
				ALT	MTR-CODE: OM 356.999;OM 366.999; MOD: 1524;1524 L; REQ: 2	AVX 13 x 1350 TM
				PS	MTR-CODE: OM 356.999;OM 366.999; MOD: 1524;1524 L	AVX 13 x 925 TM
				AIR-C	OE-NO.: 0139971692; MOD: LK/LN2;1524;1524 L; MTR-CODE: OM 356.999	10 PK 1005 TM

#### 709

3970 ccm	63-66 kW	OM 364.907;OM 364.918	03.84 - 12.98	AIR-C	MTR-CODE: OM 364.907; MOD: 709;709 K; REQ: 2	AVX 13 x 1025 TM
				ALT	MTR-CODE: OM 364.907; MOD: 709;709 K; REQ: 2	AVX 13 x 1300 TM
				PS	MTR-CODE: OM 364.907; MOD: 709;709 K	AVX 13 x 925 TM
				PS	MTR-CODE: OM 364.907;OM 364.918; MOD: 709;709 K	AVX 13 x 950 TM

#### 711

3972 ccm	77 kW	OM 354.900	03.94 - 12.98	AIR-C	MOD: 711; REQ: 2	AVX 13 x 1025 TM
				ALT	MOD: 711; REQ: 2	AVX 13 x 1300 TM
				PS	MOD: 711	AVX 13 x 925 TM

#### 811

3972 ccm	77 kW	OM 354.900	03.94 - 12.98	AIR-C	MOD: 811;811 K; REQ: 2	AVX 13 x 1025 TM
				ALT	MOD: 811;811 K; REQ: 2	AVX 13 x 1300 TM
				PS	MOD: 811;811 K	AVX 13 x 925 TM

#### 814

5958 ccm	95-100 kW	OM 356.901;OM 356.902;OM 366.905;OM 366.906;OM 366.907;OM 366.910	01.84 - 12.98	AIR-C	MTR-CODE: OM 356.901; MOD: 814 F;814 K;814 S; REQ: 2	AVX 13 x 1025 TM
				ALT	MTR-CODE: OM 356.901; MOD: 814 F;814 K;814 S; REQ: 2; - MTR-CODE: OM 366.905	AVX 13 x 1375 TM
				ALT	UNTIL MTR-NO: 937628; MTR-CODE: OM 356.901;OM 366.905; MOD: 814 F;814 K;814 S; REQ: 2	AVX 13 x 1325 TM
				HYD-P	FROM MTR-NO: 937629; MTR-CODE: OM 356.901;OM 366.905; MOD: 814 F;814 K;814 S; REQ: 2	AVX 13 x 1375 TM
				PS	MTR-CODE: OM 356.901; MOD: 814 F;814 K;814 S	AVX 13 x 925 TM



## MERCEDES-BENZ

### LK/LN2

814						
5958 ccm	95-100 kW	OM 356.905;OM 356.911;OM 366.905	01.84 - 12.98	AIR-C	MTR-CODE: OM 356.901; MOD: 814 F;814 K;814 S; REQ: 2	AVX 13 x 1025 TM
				ALT	MTR-CODE: OM 356.901; MOD: 814 F;814 K;814 S; REQ: 2; - MTR-CODE: OM 366.905	AVX 13 x 1375 TM
				ALT	UNTIL MTR-NO: 937628; MTR-CODE: OM 356.901;OM 366.905; MOD: 814 F;814 K;814 S; REQ: 2	AVX 13 x 1325 TM
				HYD-P	FROM MTR-NO: 937629; MTR-CODE: OM 356.901;OM 366.905; MOD: 814 F;814 K;814 S; REQ: 2	AVX 13 x 1375 TM
				PS	MTR-CODE: OM 356.901; MOD: 814 F;814 K;814 S	AVX 13 x 925 TM

### 814; 814L

5958 ccm	95-100 kW	OM 356.901;OM 356.902;OM 366.905;OM 366.906;OM 366.907;OM 366.910	01.84 - 12.98	AIR-C	MTR-CODE: OM 356.901; MOD: 814 F;814 K;814 S; REQ: 2	AVX 13 x 1025 TM
				ALT	MTR-CODE: OM 356.901; MOD: 814 F;814 K;814 S; REQ: 2; - MTR-CODE: OM 366.905	AVX 13 x 1375 TM
				ALT	UNTIL MTR-NO: 937628; MTR-CODE: OM 356.901;OM 366.905; MOD: 814 F;814 K;814 S; REQ: 2	AVX 13 x 1325 TM
				HYD-P	FROM MTR-NO: 937629; MTR-CODE: OM 356.901;OM 366.905; MOD: 814 F;814 K;814 S; REQ: 2	AVX 13 x 1375 TM
				PS	MTR-CODE: OM 356.901; MOD: 814 F;814 K;814 S	AVX 13 x 925 TM

### 817

5958 ccm	116-125 kW	OM 356.951;OM 357.908;OM 366.967;OM 366.973	01.84 - 12.98	AC-C	FROM MTR-NO: 937629; MTR-CODE: OM 356.951;OM 366; MOD: 817 F;817 K; REQ: 2	AVX 13 x 1350 TM
				AC-C	MTR-CODE: OM 356.951;OM 356; OM 357; MOD: 817 F;817 K; REQ: 2	AVX 13 x 1350 TM
				AIR-C	MTR-CODE: OM 356.951; MOD: 817 F;817 K; REQ: 2	AVX 13 x 1025 TM
				ALT	UNTIL MTR-NO: 937628; MTR-CODE: OM 356.951;OM 366; MOD: 817 F;817 K; REQ: 2	AVX 13 x 1300 TM
				PS	MTR-CODE: OM 356.951; MOD: 817 F;817 K	AVX 13 x 925 TM
		OM 357.900;OM 357.916;OM 366.942;OM 366.943;OM 366.967;OM 366.968		AC-C	FROM MTR-NO: 937629; MTR-CODE: OM 356.951;OM 366; MOD: 817 F;817 K; REQ: 2	AVX 13 x 1350 TM
				AC-C	MTR-CODE: OM 356.951;OM 356; OM 357; MOD: 817 F;817 K; REQ: 2	AVX 13 x 1350 TM
				AIR-C	MTR-CODE: OM 356.951; MOD: 817 F;817 K; REQ: 2	AVX 13 x 1025 TM
				ALT	UNTIL MTR-NO: 937628; MTR-CODE: OM 356.951;OM 366; MOD: 817 F;817 K; REQ: 2	AVX 13 x 1300 TM
				PS	MTR-CODE: OM 356.951; MOD: 817 F;817 K	AVX 13 x 925 TM
		OM 357.900;OM 366.942;OM 366.943;OM 366.967;OM 366.968		AC-C	FROM MTR-NO: 937629; MTR-CODE: OM 356.951;OM 366; MOD: 817 F;817 K; REQ: 2	AVX 13 x 1350 TM
				AC-C	MTR-CODE: OM 356.951;OM 356; OM 357; MOD: 817 F;817 K; REQ: 2	AVX 13 x 1350 TM
				AIR-C	MTR-CODE: OM 356.951; MOD: 817 F;817 K; REQ: 2	AVX 13 x 1025 TM
				ALT	UNTIL MTR-NO: 937628; MTR-CODE: OM 356.951;OM 366; MOD: 817 F;817 K; REQ: 2	AVX 13 x 1300 TM
				PS	MTR-CODE: OM 356.951; MOD: 817 F;817 K	AVX 13 x 925 TM
		OM 357.900;OM 366.943;OM 366.967		AC-C	FROM MTR-NO: 937629; MTR-CODE: OM 356.951;OM 366; MOD: 817 F;817 K; REQ: 2	AVX 13 x 1350 TM
				AC-C	MTR-CODE: OM 356.951;OM 356; OM 357; MOD: 817 F;817 K; REQ: 2	AVX 13 x 1350 TM
				AIR-C	MTR-CODE: OM 356.951; MOD: 817 F;817 K; REQ: 2	AVX 13 x 1025 TM
				ALT	UNTIL MTR-NO: 937628; MTR-CODE: OM 356.951;OM 366; MOD: 817 F;817 K; REQ: 2	AVX 13 x 1300 TM
				PS	MTR-CODE: OM 356.951; MOD: 817 F;817 K	AVX 13 x 925 TM

### 914

5958 ccm	95-100 kW	OM 356.901;OM 356.911;OM 366.905;OM 366.940	03.84 - 12.98	AIR-C	MTR-CODE: OM 356.901; MOD: 914;914 AK;914 K; REQ: 2	AVX 13 x 1025 TM
				ALT	MTR-CODE: OM 356;OM 356.901; MOD: 914;914 AK;914 K; REQ: 2	AVX 13 x 1375 TM
				ALT	UNTIL MTR-NO: 937628; MTR-CODE: OM 356.901;OM 366; MOD: 914;914 AK;914 K; REQ: 2	AVX 13 x 1325 TM



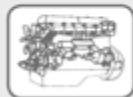

## MERCEDES-BENZ

### LK/LN2

#### 914

5958 ccm	95-100 kW	OM 356.901;OM 356.911;OM 366.905;OM 366.940	03.84 - 12.98	HYD-P	FROM MTR-NO: 937629; MTR-CODE: OM 356.901;OM 366; MOD: 914;914 AK;914 K; REQ: 2	AVX 13 x 1375 TM
				PS	MTR-CODE: OM 356.901; MOD: 914;914 AK;914 K	AVX 13 x 925 TM
		OM 356.901;OM 366.905;OM 366.907		AIR-C	MTR-CODE: OM 356.901; MOD: 914;914 AK;914 K; REQ: 2	AVX 13 x 1025 TM
				ALT	MTR-CODE: OM 356;OM 356.901; MOD: 914;914 AK;914 K; REQ: 2	AVX 13 x 1375 TM
				ALT	UNTIL MTR-NO: 937628; MTR-CODE: OM 356.901;OM 366; MOD: 914;914 AK;914 K; REQ: 2	AVX 13 x 1325 TM
				HYD-P	FROM MTR-NO: 937629; MTR-CODE: OM 356.901;OM 366; MOD: 914;914 AK;914 K; REQ: 2	AVX 13 x 1375 TM
				PS	MTR-CODE: OM 356.901; MOD: 914;914 AK;914 K	AVX 13 x 925 TM
		OM 356.901;OM 366.905;OM 366.907;OM 366.930		AIR-C	MTR-CODE: OM 356.901; MOD: 914;914 AK;914 K; REQ: 2	AVX 13 x 1025 TM
				ALT	MTR-CODE: OM 356;OM 356.901; MOD: 914;914 AK;914 K; REQ: 2	AVX 13 x 1375 TM
				ALT	UNTIL MTR-NO: 937628; MTR-CODE: OM 356.901;OM 366; MOD: 914;914 AK;914 K; REQ: 2	AVX 13 x 1325 TM
				HYD-P	FROM MTR-NO: 937629; MTR-CODE: OM 356.901;OM 366; MOD: 914;914 AK;914 K; REQ: 2	AVX 13 x 1375 TM
				PS	MTR-CODE: OM 356.901; MOD: 914;914 AK;914 K	AVX 13 x 925 TM
		OM 356.903;OM 366.918		AIR-C	MTR-CODE: OM 356.901; MOD: 914;914 AK;914 K; REQ: 2	AVX 13 x 1025 TM
				ALT	MTR-CODE: OM 356;OM 356.901; MOD: 914;914 AK;914 K; REQ: 2	AVX 13 x 1375 TM
				ALT	UNTIL MTR-NO: 937628; MTR-CODE: OM 356.901;OM 366; MOD: 914;914 AK;914 K; REQ: 2	AVX 13 x 1325 TM
				HYD-P	FROM MTR-NO: 937629; MTR-CODE: OM 356.901;OM 366; MOD: 914;914 AK;914 K; REQ: 2	AVX 13 x 1375 TM
				PS	MTR-CODE: OM 356.901; MOD: 914;914 AK;914 K	AVX 13 x 925 TM

#### 917

5958 ccm	116-125 kW	OM 356.941;OM 357.909;OM 357.910;OM 366.966;OM 366.974;OM 366.978	02.87 - 12.98	AC-C	FROM MTR-NO: 937629; MTR-CODE: OM 356.941;OM 366; MOD: 917 AF; REQ: 2	AVX 13 x 1350 TM
				AIR-C	MTR-CODE: OM 356.941; MOD: 917 AF; REQ: 2	AVX 13 x 1025 TM
				ALT	MTR-CODE: OM 356.941;OM 356; OM 357; MOD: 917 AF; REQ: 2	AVX 13 x 1350 TM
				ALT	UNTIL MTR-NO: 937628; MTR-CODE: OM 356.941;OM 366; MOD: 917 AF; REQ: 2	AVX 13 x 1300 TM
	125 kW	OM 357.900		PS	MTR-CODE: OM 356.941; MOD: 917 AF	AVX 13 x 925 TM
				AIR-C	MOD: 917;917 AK;917 K; REQ: 2	AVX 13 x 1025 TM
				ALT	MOD: 917;917 AK;917 K; REQ: 2	AVX 13 x 1350 TM
				PS	MOD: 917;917 AK;917 K	AVX 13 x 925 TM
		OM 357.901;OM 357.918		AIR-C	MTR-CODE: OM 357.900; MOD: 917;917 AK;917 K; REQ: 2	AVX 13 x 1025 TM
				ALT	MTR-CODE: OM 357.900; MOD: 917;917 AK;917 K; REQ: 2	AVX 13 x 1350 TM
				PS	MTR-CODE: OM 357.900; MOD: 917;917 AK;917 K	AVX 13 x 925 TM
		OM 357.906		AIR-C	MTR-CODE: OM 357.900; MOD: 917;917 AK;917 K; REQ: 2	AVX 13 x 1025 TM
				ALT	MTR-CODE: OM 357.900; MOD: 917;917 AK;917 K; REQ: 2	AVX 13 x 1350 TM
				PS	MTR-CODE: OM 357.900; MOD: 917;917 AK;917 K	AVX 13 x 925 TM

### MK

#### 1222

10964 ccm	160-165 kW	OM 441.905;OM 441.913;OM 441.923;OM 441.925	07.89 - 08.94	ALT	FROM MTR-NO: 632565; UNTIL MTR-NO: 712353; MTR-CODE: OM 441.905; MOD: 1222;1222 A;1222 AF	AVX 13 x 1525 TM
				ALT	UNTIL MTR-NO: 632564; MTR-CODE: OM 441.905; MOD: 1222;1222 A;1222 AF	AVX 13 x 1550 TM

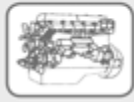

## MERCEDES-BENZ

### MK

#### 1222

10964 ccm	160-165 kW	OM 441.905;OM 441.913;OM 441.923;OM 441.925 OM 441.914;OM 441.926	07.89 - 08.94	FAN	FROM MTR-NO: 712354; MTR-CODE: OM 441.905; MOD: 1222;1222 A;1222 AF	AVX 13 x 1550 TM
				ALT	FROM MTR-NO: 632565; UNTIL MTR-NO: 712353; MTR-CODE: OM 441.905; MOD: 1222;1222 A;1222 AF	AVX 13 x 1525 TM
				ALT	UNTIL MTR-NO: 632564; MTR-CODE: OM 441.905; MOD: 1222;1222 A;1222 AF	AVX 13 x 1550 TM
				FAN	FROM MTR-NO: 712354; MTR-CODE: OM 441.905; MOD: 1222;1222 A;1222 AF	AVX 13 x 1550 TM
		OM 441.915;OM 441.917;OM 441.923		ALT	FROM MTR-NO: 632565; UNTIL MTR-NO: 712353; MTR-CODE: OM 441.905; MOD: 1222;1222 A;1222 AF	AVX 13 x 1525 TM
				ALT	UNTIL MTR-NO: 632564; MTR-CODE: OM 441.905; MOD: 1222;1222 A;1222 AF	AVX 13 x 1550 TM
				FAN	FROM MTR-NO: 712354; MTR-CODE: OM 441.905; MOD: 1222;1222 A;1222 AF	AVX 13 x 1550 TM

#### 1224

5958 ccm	170-177 kW	OM 356.999;OM 357.946;OM 366.999	07.89 - 09.96	AIR-C	MTR-CODE: OM 356.999; MOD: 1224 AF; REQ: 2	AVX 13 x 1025 TM
				ALT	MTR-CODE: OM 356.999; MOD: 1224 AF; REQ: 2	AVX 13 x 1350 TM
				PS	MTR-CODE: OM 356.999; MOD: 1224 AF	AVX 13 x 925 TM
				AIR-C	MTR-CODE: OM 356.999; MOD: MK;1224 AF; OE-NO.: 0139971692	10 PK 1005 TM
9572 ccm	180 kW	OM 401.984		ALT	FROM MTR-NO: 632565; UNTIL MTR-NO: 712353; MOD: 1224 AF	AVX 13 x 1525 TM
				ALT	FROM MTR-NO: 712354; MTR-CODE: OM 401.984; MOD: 1224 AF	AVX 13 x 1575 TM
				ALT	UNTIL MTR-NO: 632564; MTR-CODE: OM 401.984; MOD: 1224 AF	AVX 13 x 1575 TM

#### 1226

9572 ccm	180-200 kW	OM 401.973;OM 401.978;OM 401.984;OM 401.989	02.90 - 09.96	ALT	FROM MTR-NO: 632565; UNTIL MTR-NO: 712353; MTR-CODE: OM 401.973; MOD: 1226 AF	AVX 13 x 1525 TM
				ALT	FROM MTR-NO: 712354; MTR-CODE: OM 401.973; MOD: 1226 AF	AVX 13 x 1575 TM
				ALT	UNTIL MTR-NO: 632564; MTR-CODE: OM 401.973; MOD: 1226 AF	AVX 13 x 1575 TM
15080 ccm	195-218 kW	OM 442.907;OM 442.914;OM 442.920;OM 442.926;OM 442.932;OM 442.933		ALT	FROM MTR-NO: 712354; MTR-CODE: OM 442.907; MOD: 1226 AF	AVX 13 x 1550 TM
				ALT	UNTIL MTR-NO: 712353; MTR-CODE: OM 442.907; MOD: 1226 AF	AVX 13 x 1525 TM
10964 ccm	250 kW	OM 441.989		ALT	FROM MTR-NO: 632565; UNTIL MTR-NO: 712353; MOD: 1226 AF	AVX 13 x 1525 TM
				ALT	FROM MTR-NO: 712354; MTR-CODE: OM 441.989; MOD: 1226 AF	AVX 13 x 1575 TM
				ALT	UNTIL MTR-NO: 632564; MTR-CODE: OM 441.989; MOD: 1226 AF	AVX 13 x 1575 TM

#### 1227

9572 ccm	200 kW	OM 401.973;OM 401.989	01.92 - 07.92	ALT	FROM MTR-NO: 632565; UNTIL MTR-NO: 632564; MTR-CODE: OM 401.973; MOD: 1227 A	AVX 13 x 1575 TM
				ALT	FROM MTR-NO: 712354; MTR-CODE: OM 401.973; MOD: 1227 A	AVX 13 x 1575 TM
				ALT	UNTIL MTR-NO: 712353; MTR-CODE: OM 401.973; MOD: 1227 A	AVX 13 x 1525 TM

#### 1234

10964 ccm	250 kW	OM 441.989;OM 441.993;OM 445.923	01.92 - 09.96	ALT	FROM MTR-NO: 632565; UNTIL MTR-NO: 712353; MTR-CODE: OM 441.989; MOD: 1234 AF; - MTR-CODE: OM 445.923	AVX 13 x 1525 TM
				ALT	FROM MTR-NO: 712354; MTR-CODE: OM 441.989; MOD: 1234 AF; - MTR-CODE: OM 445.923	AVX 13 x 1350 TM
				ALT	UNTIL MTR-NO: 632564; MTR-CODE: OM 441.989; MOD: 1234 AF; - MTR-CODE: OM 445.923	AVX 13 x 1550 TM

#### 1417

5958 ccm	121-129 kW	OM 356.940;OM 356.943;OM 357.915;OM 366.952	07.89 - 09.96	AC-C	FROM MTR-NO: 937629; MTR-CODE: OM 356.940;OM 366.952; MOD: 1417;1417 A;1417 AK; REQ: 2	AVX 13 x 1350 TM
				AIR-C	MTR-CODE: OM 356.940; MOD: 1417;1417 A;1417 AK; REQ: 2	AVX 13 x 1025 TM
				ALT	MTR-CODE: BM356; BM357;OM 356.940; MOD: 1417;1417 A;1417 AK; REQ: 2	AVX 13 x 1350 TM

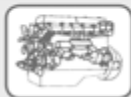

## MERCEDES-BENZ

### MK

#### 1417

5958 ccm	121-129 kW	OM 356.940;OM 356.943;OM 357.915;OM 366.952	07.89 - 09.96	ALT	UNTIL MTR-NO: 937628; MTR-CODE: OM 356.940;OM 366.952; MOD: 1417;1417 A;1417 AK; REQ: 2	AVX 13 x 1300 TM
				PS	MTR-CODE: OM 356.940; MOD: 1417;1417 A;1417 AK	AVX 13 x 925 TM
		OM 356.943;OM 357.915;OM 366.952		AC-C	FROM MTR-NO: 937629; MTR-CODE: OM 356.940;OM 366.952; MOD: 1417;1417 A;1417 AK; REQ: 2	AVX 13 x 1350 TM
	121-125 kW			AC-C	FROM MTR-NO: 937629; MTR-CODE: OM 356.940;OM 366.952; MOD: 1417;1417 A;1417 AK; REQ: 2	AVX 13 x 1350 TM
	121-129 kW			AIR-C	MTR-CODE: OM 356.940; MOD: 1417;1417 A;1417 AK; REQ: 2	AVX 13 x 1025 TM
	121-125 kW			AIR-C	MTR-CODE: OM 356.940; MOD: 1417;1417 A;1417 AK; REQ: 2	AVX 13 x 1025 TM
				ALT	MTR-CODE: BM356; BM357;OM 356.940; MOD: 1417;1417 A;1417 AK; REQ: 2	AVX 13 x 1350 TM
	121-129 kW			ALT	MTR-CODE: BM356; BM357;OM 356.940; MOD: 1417;1417 A;1417 AK; REQ: 2	AVX 13 x 1350 TM
				ALT	UNTIL MTR-NO: 937628; MTR-CODE: OM 356.940;OM 366.952; MOD: 1417;1417 A;1417 AK; REQ: 2	AVX 13 x 1300 TM
	121-125 kW			ALT	UNTIL MTR-NO: 937628; MTR-CODE: OM 356.940;OM 366.952; MOD: 1417;1417 A;1417 AK; REQ: 2	AVX 13 x 1300 TM
				PS	MTR-CODE: OM 356.940; MOD: 1417;1417 A;1417 AK	AVX 13 x 925 TM
	121-129 kW			PS	MTR-CODE: OM 356.940; MOD: 1417;1417 A;1417 AK	AVX 13 x 925 TM

#### 1420

5958 ccm	155 kW	OM 356.984;OM 356.987	12.87 - 09.96	AIR-C	MTR-CODE: OM 356.984; OE-NO.: 0099976992; MOD: 1420 LS;1420;1420 L; REQ: 2	AVX 13 x 1025 TM
				ALT	MTR-CODE: OM 356.984; MOD: 1420 LS;1420;1420 L; REQ: 2	AVX 13 x 1350 TM
				PS	MTR-CODE: OM 356.984; MOD: 1420 LS;1420;1420 L	AVX 13 x 925 TM
				AIR-C	MOD: MK;1420 LS/1420;1420 L; OE-NO.: 0139971692; MTR-CODE: OM 356.984	10 PK 1005 TM
				AIR-C	MOD: MK;1420 LS;1420 L; OE-NO.: 0139971692; MTR-CODE: OM 356.984	10 PK 1005 TM

#### 1422

11310 ccm	160-165 kW	OM 441.905;OM 441.923	12.87 - 09.96	ALT	FROM MTR-NO: 632565; UNTIL MTR-NO: 712353; MTR-CODE: OM 441.905; MOD: 1422 F	AVX 13 x 1525 TM
				ALT	UNTIL MTR-NO: 632564; MTR-CODE: OM 441.905; MOD: 1422 F	AVX 13 x 1550 TM
				FAN	FROM MTR-NO: 712354; MTR-CODE: OM 441.905; MOD: 1422 F	AVX 13 x 1550 TM
		OM 441.913;OM 441.925		ALT	FROM MTR-NO: 632565; UNTIL MTR-NO: 712353; MTR-CODE: OM 441.905; MOD: 1422 F	AVX 13 x 1525 TM
				ALT	UNTIL MTR-NO: 632564; MTR-CODE: OM 441.905; MOD: 1422 F	AVX 13 x 1550 TM
				FAN	FROM MTR-NO: 712354; MTR-CODE: OM 441.905; MOD: 1422 F	AVX 13 x 1550 TM
9572 ccm	180-230 kW	OM 401.973;OM 401.975;OM 401.978;OM 401.979		AIR-C	MTR-CODE: OM 401.973; MOD: 1422 F	AVX 13 x 1350 TM
				ALT	FROM MTR-NO: 632565; UNTIL MTR-NO: 712353; MTR-CODE: OM 401.973; MOD: 1422 F	AVX 13 x 1525 TM
				ALT	FROM MTR-NO: 712354; MTR-CODE: OM 401.973; MOD: 1422 F	AVX 13 x 1575 TM
				ALT	UNTIL MTR-NO: 632564; MTR-CODE: OM 401.973; MOD: 1422 F	AVX 13 x 1575 TM
	200 kW	OM 401.973;OM 401.977		HYD-P	MTR-CODE: OM 401.973; MOD: 1422 F; REQ: 3	AVX 13 x 1375 TM
				AIR-C	MTR-CODE: OM 401.973; MOD: 1422 LS	AVX 13 x 1350 TM
				ALT	FROM MTR-NO: 632565; UNTIL MTR-NO: 712353; MTR-CODE: OM 401.973; MOD: 1422 LS	AVX 13 x 1525 TM
				ALT	FROM MTR-NO: 712354; MTR-CODE: OM 401.973; MOD: 1422 LS	AVX 13 x 1575 TM
				ALT	UNTIL MTR-NO: 632564; MTR-CODE: OM 401.973; MOD: 1422 LS	AVX 13 x 1575 TM
				HYD-P	MTR-CODE: OM 401.973; MOD: 1422 LS; REQ: 3	AVX 13 x 1375 TM
	230 kW	OM 401.979		AIR-C	MOD: 1422	AVX 13 x 1350 TM



## MERCEDES-BENZ

MK						
<b>1422</b>						
9572 ccm	230 kW	OM 401.979	12.87 - 09.96	ALT	FROM MTR-NO: 632565; UNTIL MTR-NO: 712353; MOD: 1422	AVX 13 x 1525 TM
				ALT	FROM MTR-NO: 712354; MTR-CODE: OM 401.979; MOD: 1422	AVX 13 x 1575 TM
				ALT	UNTIL MTR-NO: 632564; MTR-CODE: OM 401.979; MOD: 1422	AVX 13 x 1575 TM
				HYD-P	MOD: 1422; REQ: 3	AVX 13 x 1375 TM
<b>1424</b>						
9600 ccm	180-200 kW	OM 401.973;OM 401.975;OM 401.977;OM 401.994	12.87 - 09.96	ALT	FROM MTR-NO: 632565; UNTIL MTR-NO: 712353; MTR-CODE: OM 401.973; MOD: 1424 S;1424 LS	AVX 13 x 1525 TM
				ALT	UNTIL MTR-NO: 632564; MTR-CODE: OM 401.973; MOD: 1424 S;1424 LS	AVX 13 x 1575 TM
				ALT	UNTIL MTR-NO: 712354; MTR-CODE: OM 401.973; MOD: 1424 S;1424 LS	AVX 13 x 1575 TM
		OM 401.973;OM 401.975;OM 401.994		ALT	FROM MTR-NO: 632565; UNTIL MTR-NO: 712353; MTR-CODE: OM 401.973; MOD: 1424 S;1424 LS	AVX 13 x 1525 TM
				ALT	UNTIL MTR-NO: 632564; MTR-CODE: OM 401.973; MOD: 1424 S;1424 LS	AVX 13 x 1575 TM
				ALT	UNTIL MTR-NO: 712354; MTR-CODE: OM 401.973; MOD: 1424 S;1424 LS	AVX 13 x 1575 TM
<b>1426</b>						
15080 ccm	191-195 kW	OM 442.914;OM 442.932	12.87 - 09.96	ALT	FROM MTR-NO: 712354; MTR-CODE: OM 442.914; MOD: 1426 S;1426 LS	AVX 13 x 1550 TM
				ALT	UNTIL MTR-NO: 712353; MTR-CODE: OM 442.914; MOD: 1426 S;1426 LS	AVX 13 x 1525 TM
<b>1427</b>						
9600 ccm	200 kW	OM 401.985;OM 401.991	12.87 - 09.96	ALT	FROM MTR-NO: 632565; UNTIL MTR-NO: 632564; MTR-CODE: OM 401.985; MOD: 1427 F; - MTR-CODE: OM 445.936	AVX 13 x 1575 TM
				ALT	FROM MTR-NO: 712354; MTR-CODE: OM 401.985; MOD: 1427 F; - MTR-CODE: OM 445.936	AVX 13 x 1575 TM
				ALT	UNTIL MTR-NO: 712353; MTR-CODE: OM 401.985; MOD: 1427 F; - MTR-CODE: OM 445.936	AVX 13 x 1525 TM
<b>1717</b>						
5958 ccm	129 kW	OM 356.940;OM 366.952	12.87 - 09.96	AIR-C	MTR-CODE: BM356;OM 356.940; MOD: 1717 AK;1717 K; REQ: 2	AVX 13 x 1350 TM
				AIR-C	MTR-CODE: OM 356.940; MOD: 1717 AK;1717 K; REQ: 2	AVX 13 x 1025 TM
				ALT	FROM MTR-NO: 937629; MTR-CODE: OM 356.940;OM366952; MOD: 1717 AK;1717 K; REQ: 2	AVX 13 x 1250 TM
				ALT	UNTIL MTR-NO: 937628; MTR-CODE: OM 356.940;OM366952; MOD: 1717 AK;1717 K	AVX 13 x 1300 TM
				ALT	UNTIL MTR-NO: 937628; MTR-CODE: OM 356.940;OM366952; MOD: 1717 AK;1717 K; REQ: 2	AVX 13 x 1300 TM
				PS	MTR-CODE: OM 356.940; MOD: 1717 AK;1717 K	AVX 13 x 925 TM
<b>1720</b>						
5958 ccm	150-155 kW	OM 356.984;OM 356.985;OM 366.983	12.87 - 09.96	AIR-C	MTR-CODE: OM 356.984; OE-NO.: 0099976992; MOD: 1720 S;1720 L; REQ: 2	AVX 13 x 1025 TM
				ALT	MTR-CODE: OM 356.984; MOD: 1720 S;1720 L; REQ: 2	AVX 13 x 1350 TM
				PS	MTR-CODE: OM 356.984; MOD: 1720 S;1720 L	AVX 13 x 925 TM
				AIR-C	MTR-CODE: OM 356.984; MOD: MK;1720 S/1720 L; OE-NO.: 0139971692	10 PK 1005 TM
	155 kW	OM 356.984		AIR-C	OE-NO.: 0099976992; MOD: 1720 S;1720 L; REQ: 2	AVX 13 x 1025 TM
				ALT	MOD: 1720 S;1720 L; REQ: 2	AVX 13 x 1350 TM
				PS	MOD: 1720 S;1720 L	AVX 13 x 925 TM
				AIR-C	MTR-CODE: OM 356.984; MOD: MK;1720S/1720 L; OE-NO.: 0139971692	10 PK 1005 TM
<b>1722</b>						
5958 ccm	150 kW	OM 366.983	12.87 - 09.96	AIR-C	OE-NO.: 0099976992; MOD: 1722 L; REQ: 2	AVX 13 x 1025 TM
				ALT	FROM MTR-NO: 937629; MOD: 1722 L; REQ: 2	AVX 13 x 1350 TM
				ALT	UNTIL MTR-NO: 937628; MOD: 1722 L; REQ: 2	AVX 13 x 1300 TM
				PS	MOD: 1722 L	AVX 13 x 925 TM



## MERCEDES-BENZ

### MK

#### 1722

5958 ccm	150 kW	OM 366.983	12.87 - 09.96	AIR-C	MTR-CODE: OM 366.983; MOD: MK;1722 L; OE-NO.: 0139971692	<b>10 PK 1005 TM</b>	
11309 ccm	151-165 kW	OM 441.905;OM 441.913;OM 441.914;OM 441.916;OM 441.920;OM 441.923;OM 441.932		ALT	FROM MTR-NO: 632565; UNTIL MTR-NO: 712353; MTR-CODE: OM 441.905; MOD: 1722 AK;1722 K	<b>AVX 13 x 1525 TM</b>	
				ALT	UNTIL MTR-NO: 632564; MTR-CODE: OM 441.905; MOD: 1722 AK;1722 K	<b>AVX 13 x 1550 TM</b>	
				FAN	FROM MTR-NO: 712354; MTR-CODE: OM 441.905; MOD: 1722 AK;1722 K	<b>AVX 13 x 1550 TM</b>	
				ALT	FROM MTR-NO: 632565; UNTIL MTR-NO: 712353; MTR-CODE: OM 441.905; MOD: 1722 AK;1722 K	<b>AVX 13 x 1525 TM</b>	
				ALT	UNTIL MTR-NO: 632564; MTR-CODE: OM 441.905; MOD: 1722 AK;1722 K	<b>AVX 13 x 1550 TM</b>	
				FAN	FROM MTR-NO: 712354; MTR-CODE: OM 441.905; MOD: 1722 AK;1722 K	<b>AVX 13 x 1550 TM</b>	
	153-165 kW	OM 441.905;OM 441.913;OM 441.914;OM 441.916;OM 441.920;OM 441.923			ALT	FROM MTR-NO: 632565; UNTIL MTR-NO: 712353; MTR-CODE: OM 441.905; MOD: 1722 AK;1722 K	<b>AVX 13 x 1525 TM</b>
					ALT	UNTIL MTR-NO: 632564; MTR-CODE: OM 441.905; MOD: 1722 AK;1722 K	<b>AVX 13 x 1550 TM</b>
					FAN	FROM MTR-NO: 712354; MTR-CODE: OM 441.905; MOD: 1722 AK;1722 K	<b>AVX 13 x 1550 TM</b>
					ALT	UNTIL MTR-NO: 632564; MTR-CODE: OM 441.905; MOD: 1722 AK;1722 K	<b>AVX 13 x 1525 TM</b>
					ALT	UNTIL MTR-NO: 632564; MTR-CODE: OM 441.905; MOD: 1722 AK;1722 K	<b>AVX 13 x 1550 TM</b>
					FAN	FROM MTR-NO: 712354; MTR-CODE: OM 441.905; MOD: 1722 AK;1722 K	<b>AVX 13 x 1550 TM</b>
9572 ccm	200 kW	OM 401.973;OM 401.978		AIR-C	MTR-CODE: OM 401.973; MOD: 1722 AK	<b>AVX 13 x 1350 TM</b>	
				ALT	FROM MTR-NO: 632565; UNTIL MTR-NO: 712353; MTR-CODE: OM 401.973; MOD: 1722 AK	<b>AVX 13 x 1525 TM</b>	
				ALT	FROM MTR-NO: 712354; MTR-CODE: OM 401.973; MOD: 1722 AK	<b>AVX 13 x 1575 TM</b>	
				ALT	UNTIL MTR-NO: 632564; MTR-CODE: OM 401.973; MOD: 1722 AK	<b>AVX 13 x 1575 TM</b>	
				HYD-P	MTR-CODE: OM 401.973; MOD: 1722 AK; REQ: 3	<b>AVX 13 x 1375 TM</b>	
				ALT	OE-NO.: 0039973092; MOD: 1722	<b>AVX 13 x 1525 TM</b>	
15080 ccm	218 kW	OM 442.907		ALT	OE-NO.: 0039973092; MOD: 1722	<b>AVX 13 x 1525 TM</b>	
				ALT	OE-NO.: 0059972792; MOD: 1722	<b>AVX 13 x 1550 TM</b>	

#### 1726

15080 ccm	195 kW	OM 440.909;OM 442.914;OM 442.922;OM 442.932	12.87 - 09.96	ALT	FROM MTR-NO: 712354; MTR-CODE: OM 440.909; MOD: 1726 AK;1726 K	<b>AVX 13 x 1550 TM</b>	
				ALT	UNTIL MTR-NO: 712353; MTR-CODE: OM 440.909; MOD: 1726 AK;1726 K	<b>AVX 13 x 1525 TM</b>	
				ALT	FROM MTR-NO: 712354; MTR-CODE: OM 440.909; MOD: 1726 AK;1726 K	<b>AVX 13 x 1550 TM</b>	
				ALT	UNTIL MTR-NO: 712353; MTR-CODE: OM 440.909; MOD: 1726 AK;1726 K	<b>AVX 13 x 1525 TM</b>	
				ALT	FROM MTR-NO: 712354; MTR-CODE: OM 440.909; MOD: 1726 AK;1726 K	<b>AVX 13 x 1550 TM</b>	
				ALT	UNTIL MTR-NO: 712353; MTR-CODE: OM 440.909; MOD: 1726 AK;1726 K	<b>AVX 13 x 1525 TM</b>	
	195 kW	OM 442.922;OM 442.935			ALT	FROM MTR-NO: 712354; MTR-CODE: OM 440.909; MOD: 1726 AK;1726 K	<b>AVX 13 x 1550 TM</b>
					ALT	UNTIL MTR-NO: 712353; MTR-CODE: OM 440.909; MOD: 1726 AK;1726 K	<b>AVX 13 x 1525 TM</b>
					ALT	FROM MTR-NO: 712354; MTR-CODE: OM 440.909; MOD: 1726 AK;1726 K	<b>AVX 13 x 1550 TM</b>
					ALT	UNTIL MTR-NO: 712353; MTR-CODE: OM 440.909; MOD: 1726 AK;1726 K	<b>AVX 13 x 1525 TM</b>
					ALT	FROM MTR-NO: 712354; MTR-CODE: OM 440.909; MOD: 1726 AK;1726 K	<b>AVX 13 x 1550 TM</b>
					ALT	UNTIL MTR-NO: 712353; MTR-CODE: OM 440.909; MOD: 1726 AK;1726 K	<b>AVX 13 x 1525 TM</b>
10964 ccm	250 kW	OM 441.960		ALT	FROM MTR-NO: 632565; UNTIL MTR-NO: 712353; MOD: 1726 L	<b>AVX 13 x 1525 TM</b>	
				ALT	FROM MTR-NO: 712354; MTR-CODE: OM 441.960; MOD: 1726 L	<b>AVX 13 x 1575 TM</b>	
				ALT	UNTIL MTR-NO: 632564; MTR-CODE: OM 441.960; MOD: 1726 L	<b>AVX 13 x 1575 TM</b>	
				ALT	FROM MTR-NO: 712354; MTR-CODE: OM 441.960; MOD: 1726 L	<b>AVX 13 x 1575 TM</b>	
				ALT	UNTIL MTR-NO: 632564; MTR-CODE: OM 441.960; MOD: 1726 L	<b>AVX 13 x 1575 TM</b>	
				ALT	FROM MTR-NO: 712354; MTR-CODE: OM 441.960; MOD: 1726 L	<b>AVX 13 x 1575 TM</b>	

#### 1727

9572 ccm	200 kW	OM 401.973;OM 401.978	12.88 - 08.94	ALT	FROM MTR-NO: 632565; UNTIL MTR-NO: 712353; MTR-CODE: OM 401.973; MOD: 1726 L	<b>AVX 13 x 1525 TM</b>
				ALT	FROM MTR-NO: 712354; MTR-CODE: OM 401.973; MOD: 1726 L	<b>AVX 13 x 1575 TM</b>
				ALT	UNTIL MTR-NO: 632564; MTR-CODE: OM 401.973; MOD: 1726 L	<b>AVX 13 x 1575 TM</b>

#### 1733

10964 ccm	243-249 kW	OM 441.960;OM 441.962;OM 441.981;OM 441.983	12.87 - 09.96	AIR-C	MTR-CODE: OM 441.960; MOD: 1733 S;1733 LS	<b>AVX 13 x 1350 TM</b>
				ALT	FROM MTR-NO: 632565; UNTIL MTR-NO: 712353; MTR-CODE: OM 441.960; MOD: 1733 S;1733 LS	<b>AVX 13 x 1525 TM</b>



## MERCEDES-BENZ

### MK

#### 1733

10964 ccm	243-249 kW	OM 441.960;OM 441.962;OM 441.981;OM 441.983	12.87 - 09.96	ALT	FROM MTR-NO: 712354; MTR-CODE: OM 441.960; MOD: 1733 S;1733 LS; REQ: 2	AVX 13 x 1575 TM
				ALT	UNTIL MTR-NO: 632564; MTR-CODE: OM 441.960; MOD: 1733 S;1733 LS	AVX 13 x 1575 TM
				HYD-P	MTR-CODE: OM 441.960; MOD: 1733 S;1733 LS; REQ: 3	AVX 13 x 1375 TM

#### 1733; 1734

10964 ccm	243-250 kW	OM 441.960;OM 441.962;OM 441.981;OM 441.983;OM 441.986;OM 441.989;OM 445.920;OM 445.939	12.87 - 09.96	AIR-C	MTR-CODE: OM 441.960; MOD: 1733 S;1733 LS	AVX 13 x 1350 TM
				ALT	FROM MTR-NO: 632565; UNTIL MTR-NO: 712353; MTR-CODE: OM 441.960; MOD: 1733 S;1733 LS	AVX 13 x 1525 TM
				ALT	FROM MTR-NO: 712354; MTR-CODE: OM 441.960; MOD: 1733 S;1733 LS; REQ: 2	AVX 13 x 1575 TM
				ALT	UNTIL MTR-NO: 632564; MTR-CODE: OM 441.960; MOD: 1733 S;1733 LS	AVX 13 x 1575 TM
				HYD-P	MTR-CODE: OM 441.960; MOD: 1733 S;1733 LS; REQ: 3	AVX 13 x 1375 TM

#### 1820

5958 ccm	155 kW	OM 356.984;OM 356.987;OM 357.925  OM 356.987;OM 357.925	12.87 - 09.96	AIR-C	MTR-CODE: OM 356.984; OE-NO.: 0099976992; MOD: 1820 AK;1820 K; REQ: 2	AVX 13 x 1025 TM
				ALT	MTR-CODE: OM 356.984; MOD: 1820 AK;1820 K; REQ: 2	AVX 13 x 1350 TM
				PS	MTR-CODE: OM 356.984; MOD: 1820 AK;1820 K	AVX 13 x 925 TM
				AIR-C	MOD: MK;1820 AK/1820 K; OE-NO.: 0139971692	10 PK 1005 TM
				AC-C	MTR-CODE: OM 356.984; OE-NO.: 0099976992; MOD: 1820 AK;1820 K; REQ: 2	AVX 13 x 1025 TM
				AIR-C	MTR-CODE: OM 356.984; OE-NO.: 0099976992; MOD: 1820 AK;1820 K; REQ: 2	AVX 13 x 1025 TM
				ALT	MTR-CODE: OM 356.984; MOD: 1820 AK;1820 K; REQ: 2	AVX 13 x 1350 TM
				PS	MTR-CODE: OM 356.984; MOD: 1820 AK;1820 K	AVX 13 x 925 TM
				AIR-C	MOD: MK;1820 AK/1820K; OE-NO.: 0139971692; MTR-CODE: OM 356.984	10 PK 1005 TM
				AIR-C	MTR-CODE: OM 356.984; MOD: MK;1820 AK/1820 K; OE-NO.: 0139971692	10 PK 1005 TM

#### 1824

9572 ccm	180 kW	OM 401.975  OM 401.984;OM 401.990	12.87 - 09.96	ALT	FROM MTR-NO: 632565; UNTIL MTR-NO: 712353; MOD: 1824 AK;1824 K	AVX 13 x 1525 TM
				ALT	FROM MTR-NO: 712354; MTR-CODE: OM 401.975; MOD: 1824 AK;1824 K	AVX 13 x 1575 TM
				ALT	UNTIL MTR-NO: 632564; MTR-CODE: OM 401.975; MOD: 1824 AK;1824 K	AVX 13 x 1575 TM
				ALT	FROM MTR-NO: 632565; UNTIL MTR-NO: 712353; MTR-CODE: OM 401.975; MOD: 1824 AK;1824 K	AVX 13 x 1525 TM
				ALT	FROM MTR-NO: 712354; MTR-CODE: OM 401.975; MOD: 1824 AK;1824 K	AVX 13 x 1575 TM
				ALT	UNTIL MTR-NO: 632564; MTR-CODE: OM 401.975; MOD: 1824 AK;1824 K	AVX 13 x 1575 TM

#### 1827

9572 ccm	200 kW	OM 401.973;OM 401.977;OM 401.991	12.87 - 09.96	ALT	FROM MTR-NO: 632565; UNTIL MTR-NO: 632564; MTR-CODE: OM 401.973; MOD: 1827 S;1827 LS; - MTR-CODE: OM 445.936	AVX 13 x 1575 TM
				ALT	FROM MTR-NO: 712354; MTR-CODE: OM 401.973; MOD: 1827 S;1827 LS; - MTR-CODE: OM 445.936	AVX 13 x 1575 TM
				ALT	UNTIL MTR-NO: 712353; MTR-CODE: OM 401.973; MOD: 1827 S;1827 LS; - MTR-CODE: OM 445.936	AVX 13 x 1525 TM

#### 2420

5958 ccm	150-155 kW	OM 356.984;OM 366.983	12.87 - 09.96	AC-C	FROM MTR-NO: 937629; MTR-CODE: OM 356.984;OM366983; MOD: 2420;2420 L; REQ: 2	AVX 13 x 1350 TM
				AIR-C	MTR-CODE: OM 356.984; OE-NO.: 0099976992; MOD: 2420;2420 L; REQ: 2	AVX 13 x 1025 TM
				ALT	MTR-CODE: OM 356.984;OM356984; MOD: 2420;2420 L; REQ: 2	AVX 13 x 1350 TM
				ALT	UNTIL MTR-NO: 937628; MTR-CODE: OM 356.984;OM366983; MOD: 2420;2420 L; REQ: 2	AVX 13 x 1300 TM



## MERCEDES-BENZ

### MK

#### 2420

5958 ccm	150-155 kW	OM 356.984;OM 366.983	12.87 - 09.96	PS AIR-C	MTR-CODE: OM 356.984; MOD: 2420;2420 L MOD: MK;2420;2420 L; MTR-CODE: OM 356.984	<b>AVX 13 x 925 TM</b> <b>10 PK 1005 TM</b>
----------	------------	-----------------------	---------------	-------------	---	--

#### 2422

11309 ccm	153-165 kW	OM 441.905;OM 441.920;OM 441.923;OM 441.924	12.87 - 09.96	ALT	FROM MTR-NO: 632565; UNTIL MTR-NO: 712353; MTR-CODE: OM 441.905; MOD: 2422;2422 B;2422 K	<b>AVX 13 x 1525 TM</b>
-----------	------------	---	---------------	-----	--	-------------------------

				ALT	UNTIL MTR-NO: 632564; MTR-CODE: OM 441.905; MOD: 2422;2422 B;2422 K	<b>AVX 13 x 1550 TM</b>
--	--	--	--	-----	---	-------------------------

				FAN	FROM MTR-NO: 712354; MTR-CODE: OM 441.905; MOD: 2422;2422 B;2422 K	<b>AVX 13 x 1550 TM</b>
--	--	--	--	-----	--	-------------------------

	160-165 kW	OM 441.905;OM 441.912;OM 441.923;OM 441.924		ALT	FROM MTR-NO: 632565; UNTIL MTR-NO: 712353; MTR-CODE: OM 441.905; MOD: 2422;2422 B;2422 K	<b>AVX 13 x 1525 TM</b>
--	------------	---	--	-----	--	-------------------------

				ALT	UNTIL MTR-NO: 632564; MTR-CODE: OM 441.905; MOD: 2422;2422 B;2422 K	<b>AVX 13 x 1550 TM</b>
--	--	--	--	-----	---	-------------------------

				FAN	FROM MTR-NO: 712354; MTR-CODE: OM 441.905; MOD: 2422;2422 B;2422 K	<b>AVX 13 x 1550 TM</b>
--	--	--	--	-----	--	-------------------------

		OM 441.912;OM 441.924		ALT	FROM MTR-NO: 632565; UNTIL MTR-NO: 712353; MTR-CODE: OM 441.905; MOD: 2422;2422 B;2422 K	<b>AVX 13 x 1525 TM</b>
--	--	-----------------------	--	-----	--	-------------------------

				ALT	UNTIL MTR-NO: 632564; MTR-CODE: OM 441.905; MOD: 2422;2422 B;2422 K	<b>AVX 13 x 1550 TM</b>
--	--	--	--	-----	---	-------------------------

				FAN	FROM MTR-NO: 712354; MTR-CODE: OM 441.905; MOD: 2422;2422 B;2422 K	<b>AVX 13 x 1550 TM</b>
--	--	--	--	-----	--	-------------------------

10964 ccm	160 kW	OM 441.923		ALT	FROM MTR-NO: 632565; UNTIL MTR-NO: 712353; MTR-CODE: OM 441.905; MOD: 2422;2422 B;2422 K	<b>AVX 13 x 1525 TM</b>
-----------	--------	------------	--	-----	--	-------------------------

				ALT	UNTIL MTR-NO: 632564; MTR-CODE: OM 441.905; MOD: 2422;2422 B;2422 K	<b>AVX 13 x 1550 TM</b>
--	--	--	--	-----	---	-------------------------

				FAN	FROM MTR-NO: 712354; MTR-CODE: OM 441.905; MOD: 2422;2422 B;2422 K	<b>AVX 13 x 1550 TM</b>
--	--	--	--	-----	--	-------------------------

#### 2426

15080 ccm	195 kW	OM 442.914;OM 442.921;OM 442.932;OM 442.934	12.87 - 09.96	ALT	FROM MTR-NO: 712354; MTR-CODE: OM 442.914; MOD: 2426;2426 B;2426 L	<b>AVX 13 x 1550 TM</b>
-----------	--------	---	---------------	-----	--	-------------------------

				ALT	UNTIL MTR-NO: 712353; MTR-CODE: OM 442.914; MOD: 2426;2426 B;2426 L	<b>AVX 13 x 1525 TM</b>
--	--	--	--	-----	---	-------------------------

		OM 442.914;OM 442.922;OM 442.932		ALT	FROM MTR-NO: 712354; MTR-CODE: OM 442.914; MOD: 2426;2426 B;2426 L	<b>AVX 13 x 1550 TM</b>
--	--	----------------------------------	--	-----	--	-------------------------

				ALT	UNTIL MTR-NO: 712353; MTR-CODE: OM 442.914; MOD: 2426;2426 B;2426 L	<b>AVX 13 x 1525 TM</b>
--	--	--	--	-----	---	-------------------------

		OM 442.921		ALT	FROM MTR-NO: 712354; MTR-CODE: OM 442.914; MOD: 2426;2426 B;2426 L	<b>AVX 13 x 1550 TM</b>
--	--	------------	--	-----	--	-------------------------

				ALT	UNTIL MTR-NO: 712353; MTR-CODE: OM 442.914; MOD: 2426;2426 B;2426 L	<b>AVX 13 x 1525 TM</b>
--	--	--	--	-----	---	-------------------------

#### 2433

10964 ccm	243-249 kW	OM 441.960;OM 441.962;OM 441.981;OM 441.983	12.87 - 09.96	AIR-C	MTR-CODE: OM 441.960; MOD: 2433 K	<b>AVX 13 x 1350 TM</b>
-----------	------------	---	---------------	-------	-----------------------------------	-------------------------

				ALT	FROM MTR-NO: 712353; UNTIL MTR-NO: 632565; MTR-CODE: OM 441.960; MOD: 2433 K	<b>AVX 13 x 1525 TM</b>
--	--	--	--	-----	--	-------------------------

				ALT	FROM MTR-NO: 712354; MTR-CODE: OM 441.960; MOD: 2433 K; REQ: 2	<b>AVX 13 x 1575 TM</b>
--	--	--	--	-----	--	-------------------------

				ALT	UNTIL MTR-NO: 632564; MTR-CODE: OM 441.960; MOD: 2433 K	<b>AVX 13 x 1575 TM</b>
--	--	--	--	-----	---	-------------------------

	249 kW	OM 441.960;OM 441.981		HYD-P	MTR-CODE: OM 441.960; MOD: 2433 K; REQ: 3	<b>AVX 13 x 1375 TM</b>
--	--------	-----------------------	--	-------	---	-------------------------

				AIR-C	MTR-CODE: OM 441.960; MOD: 2433 K	<b>AVX 13 x 1350 TM</b>
--	--	--	--	-------	-----------------------------------	-------------------------

				ALT	FROM MTR-NO: 712353; UNTIL MTR-NO: 632565; MTR-CODE: OM 441.960; MOD: 2433 K	<b>AVX 13 x 1525 TM</b>
--	--	--	--	-----	--	-------------------------

				ALT	FROM MTR-NO: 712354; MTR-CODE: OM 441.960; MOD: 2433 K; REQ: 2	<b>AVX 13 x 1575 TM</b>
--	--	--	--	-----	--	-------------------------

				ALT	UNTIL MTR-NO: 632564; MTR-CODE: OM 441.960; MOD: 2433 K	<b>AVX 13 x 1575 TM</b>
--	--	--	--	-----	---	-------------------------

				HYD-P	MTR-CODE: OM 441.960; MOD: 2433 K; REQ: 3	<b>AVX 13 x 1375 TM</b>
--	--	--	--	-------	---	-------------------------

#### 2433; 2434

10964 ccm	243-250 kW	OM 441.960;OM 441.962;OM 441.981;OM 441.983;OM 441.986;OM 441.989;OM 445.920;OM 445.939	12.87 - 09.96	AIR-C	MTR-CODE: OM 441.960; MOD: 2433 K	<b>AVX 13 x 1350 TM</b>
-----------	------------	---	---------------	-------	-----------------------------------	-------------------------

				ALT	FROM MTR-NO: 712353; UNTIL MTR-NO: 632565; MTR-CODE: OM 441.960; MOD: 2433 K	<b>AVX 13 x 1525 TM</b>
--	--	--	--	-----	--	-------------------------

				ALT	FROM MTR-NO: 712354; MTR-CODE: OM 441.960; MOD: 2433 K; REQ: 2	<b>AVX 13 x 1575 TM</b>
--	--	--	--	-----	--	-------------------------

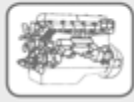

## MERCEDES-BENZ

### MK

#### 2433; 2434

10964 ccm	243-250 kW	OM 441.960;OM 441.962;OM 441.981;OM 441.983;OM 441.986;OM 441.989;OM 445.920;OM 445.939	12.87 - 09.96	ALT	UNTIL MTR-NO: 632564; MTR-CODE: OM 441.960; MOD: 2433 K	<b>AVX 13 x 1575 TM</b>
				HYD-P	MTR-CODE: OM 441.960; MOD: 2433 K; REQ: 3	<b>AVX 13 x 1375 TM</b>

#### 2524

9600 ccm	180-200 kW	OM 401.973;OM 401.975	12.87 - 09.96	ALT	FROM MTR-NO: 632565; UNTIL MTR-NO: 712353; MTR-CODE: OM 401.973; MOD: 2524;2524 K	<b>AVX 13 x 1525 TM</b>
				ALT	FROM MTR-NO: 712354; MTR-CODE: OM 401.973; MOD: 2524;2524 K	<b>AVX 13 x 1575 TM</b>
				ALT	UNTIL MTR-NO: 632564; MTR-CODE: OM 401.973; MOD: 2524;2524 K	<b>AVX 13 x 1575 TM</b>
180 kW		OM 401.975		ALT	FROM MTR-NO: 632565; UNTIL MTR-NO: 712353; MTR-CODE: OM 401.973; MOD: 2524;2524 K	<b>AVX 13 x 1525 TM</b>
				ALT	FROM MTR-NO: 712354; MTR-CODE: OM 401.973; MOD: 2524;2524 K	<b>AVX 13 x 1575 TM</b>
				ALT	UNTIL MTR-NO: 632564; MTR-CODE: OM 401.973; MOD: 2524;2524 K	<b>AVX 13 x 1575 TM</b>

#### 2527

9572 ccm	200 kW	OM 401.973	12.87 - 09.96	ALT	FROM MTR-NO: 632565; UNTIL MTR-NO: 632564; MTR-CODE: OM 401.973; MOD: 2527;2527 B;2527 K; - MTR-CODE: OM 445.936	<b>AVX 13 x 1575 TM</b>
				ALT	FROM MTR-NO: 712354; MTR-CODE: OM 401.973; MOD: 2527;2527 B;2527 K; - MTR-CODE: OM 445.936	<b>AVX 13 x 1575 TM</b>
				ALT	UNTIL MTR-NO: 712353; MOD: 2527;2527 B;2527 K; - MTR-CODE: OM 445.936	<b>AVX 13 x 1525 TM</b>
200-230 kW		OM 401.973;OM 401.977;OM 401.979		ALT	FROM MTR-NO: 632565; UNTIL MTR-NO: 632564; MTR-CODE: OM 401.973; MOD: 2527;2527 B;2527 K; - MTR-CODE: OM 445.936	<b>AVX 13 x 1575 TM</b>
				ALT	FROM MTR-NO: 712354; MTR-CODE: OM 401.973; MOD: 2527;2527 B;2527 K; - MTR-CODE: OM 445.936	<b>AVX 13 x 1575 TM</b>
				ALT	UNTIL MTR-NO: 712353; MTR-CODE: OM 401.973; MOD: 2527;2527 B;2527 K; - MTR-CODE: OM 445.936	<b>AVX 13 x 1525 TM</b>
200 kW		OM 401.973;OM 401.978;OM 401.980		ALT	FROM MTR-NO: 632565; UNTIL MTR-NO: 632564; MTR-CODE: OM 401.973; MOD: 2527;2527 B;2527 K; - MTR-CODE: OM 445.936	<b>AVX 13 x 1575 TM</b>
				ALT	FROM MTR-NO: 712354; MTR-CODE: OM 401.973; MOD: 2527;2527 B;2527 K; - MTR-CODE: OM 445.936	<b>AVX 13 x 1575 TM</b>
				ALT	UNTIL MTR-NO: 712353; MTR-CODE: OM 401.973; MOD: 2527;2527 B;2527 K; - MTR-CODE: OM 445.936	<b>AVX 13 x 1525 TM</b>

#### 2534

10964 ccm	250 kW	OM 441.986;OM 441.987;OM 441.989;OM 441.991;OM 445.920;OM 445.921;OM 445.922	12.87 - 09.96	AIR-C	FROM MTR-NO: 712354; MTR-CODE: OM 441.986; MOD: 2534 K; - MTR-CODE: OM 445.920	<b>AVX 13 x 1350 TM</b>
				ALT	FROM MTR-NO: 632565; UNTIL MTR-NO: 712353; MTR-CODE: OM 441.986; MOD: 2534 K; - MTR-CODE: OM 445.920	<b>AVX 13 x 1525 TM</b>
				ALT	UNTIL MTR-NO: 632564; MTR-CODE: OM 441.986; MOD: 2534 K; - MTR-CODE: OM 445.920	<b>AVX 13 x 1550 TM</b>
		OM 441.986;OM 441.987;OM 445.920;OM 445.921;OM 445.922		AIR-C	FROM MTR-NO: 712354; MTR-CODE: OM 441.986; MOD: 2534 K; - MTR-CODE: OM 445.920	<b>AVX 13 x 1350 TM</b>
				ALT	FROM MTR-NO: 632565; UNTIL MTR-NO: 712353; MTR-CODE: OM 441.986; MOD: 2534 K; - MTR-CODE: OM 445.920	<b>AVX 13 x 1525 TM</b>
				ALT	UNTIL MTR-NO: 632564; MTR-CODE: OM 441.986; MOD: 2534 K; - MTR-CODE: OM 445.920	<b>AVX 13 x 1550 TM</b>
		OM 441.986;OM 441.989;OM 445.920		AIR-C	FROM MTR-NO: 712354; MTR-CODE: OM 441.986; MOD: 2534 K; - MTR-CODE: OM 445.920	<b>AVX 13 x 1350 TM</b>
				ALT	FROM MTR-NO: 632565; UNTIL MTR-NO: 712353; MTR-CODE: OM 441.986; MOD: 2534 K; - MTR-CODE: OM 445.920	<b>AVX 13 x 1525 TM</b>
				ALT	UNTIL MTR-NO: 632564; MTR-CODE: OM 441.986; MOD: 2534 K; - MTR-CODE: OM 445.920	<b>AVX 13 x 1550 TM</b>



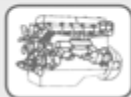

## MERCEDES-BENZ

### NG

#### 1217

5700 ccm	124 kW	OM 353.950;OM 353.951	08.73 - 09.96	AC-C	MTR-CODE: OM 353.950;OM 353.953; OE-NO.: 0099976592; MOD: 1217 A;1217 AK; REQ: 2	AVX 13 x 1350 TM
				AC-C	MTR-CODE: OM 353.950;OM 353.970; OE-NO.: 0099976592; MOD: 1217 A;1217 AK; REQ: 2	AVX 13 x 1350 TM
				AIR-C	MTR-CODE: OM 353.950; MOD: 1217 A;1217 AK; REQ: 2; - MTR-CODE: OM 353.970	AVX 13 x 1325 TM
				AIR-C	MTR-CODE: OM 353.950;OM 353.970; MOD: 1217 A;1217 AK	AVX 13 x 1025 TM
				ALT	MTR-CODE: OM 353.950; MOD: 1217 A;1217 AK; REQ: 2	AVX 13 x 1350 TM
				ALT	MTR-CODE: OM 353.950;OM 353.970; OE-NO.: 0099977692; MOD: 1217 A;1217 AK; REQ: 2	AVX 13 x 1300 TM
				ALT	UNTIL MTR-NO: 837405; MTR-CODE: OM 353.950; MOD: 1217 A;1217 AK; REQ: 2	AVX 13 x 1000 TM
				S-PUL	FROM MTR-NO: 837406; MTR-CODE: OM 353.950; MOD: 1217 A;1217 AK; REQ: 2	AVX 13 x 1125 TM
				W-P	MTR-CODE: OM 353.950; MOD: 1217 A;1217 AK; REQ: 2; - MTR-CODE: OM 353.970	AVX 13 x 1325 TM
		OM 353.950;OM 353.951;OM 353.952;OM 353.953		AC-C	MTR-CODE: OM 353.950;OM 353.953; OE-NO.: 0099976592; MOD: 1217 A;1217 AK; REQ: 2	AVX 13 x 1350 TM
				AC-C	MTR-CODE: OM 353.950;OM 353.970; OE-NO.: 0099976592; MOD: 1217 A;1217 AK; REQ: 2	AVX 13 x 1350 TM
				AIR-C	MTR-CODE: OM 353.950; MOD: 1217 A;1217 AK; REQ: 2; - MTR-CODE: OM 353.970	AVX 13 x 1325 TM
				AIR-C	MTR-CODE: OM 353.950;OM 353.970; MOD: 1217 A;1217 AK	AVX 13 x 1025 TM
				ALT	MTR-CODE: OM 353.950; MOD: 1217 A;1217 AK; REQ: 2	AVX 13 x 1350 TM
				ALT	MTR-CODE: OM 353.950;OM 353.970; OE-NO.: 0099977692; MOD: 1217 A;1217 AK; REQ: 2	AVX 13 x 1300 TM
				ALT	UNTIL MTR-NO: 837405; MTR-CODE: OM 353.950; MOD: 1217 A;1217 AK; REQ: 2	AVX 13 x 1000 TM
				S-PUL	FROM MTR-NO: 837406; MTR-CODE: OM 353.950; MOD: 1217 A;1217 AK; REQ: 2	AVX 13 x 1125 TM
				W-P	MTR-CODE: OM 353.950; MOD: 1217 A;1217 AK; REQ: 2; - MTR-CODE: OM 353.970	AVX 13 x 1325 TM
		OM 353.950;OM 353.951;OM 353.952;OM 353.953;OM 353.970;OM 353.971		AC-C	MTR-CODE: OM 353.950;OM 353.953; OE-NO.: 0099976592; MOD: 1217 A;1217 AK; REQ: 2	AVX 13 x 1350 TM
				AC-C	MTR-CODE: OM 353.950;OM 353.970; OE-NO.: 0099976592; MOD: 1217 A;1217 AK; REQ: 2	AVX 13 x 1350 TM
				AIR-C	MTR-CODE: OM 353.950; MOD: 1217 A;1217 AK; REQ: 2; - MTR-CODE: OM 353.970	AVX 13 x 1325 TM
				AIR-C	MTR-CODE: OM 353.950;OM 353.970; MOD: 1217 A;1217 AK	AVX 13 x 1025 TM
				ALT	MTR-CODE: OM 353.950; MOD: 1217 A;1217 AK; REQ: 2	AVX 13 x 1350 TM
				ALT	MTR-CODE: OM 353.950;OM 353.970; OE-NO.: 0099977692; MOD: 1217 A;1217 AK; REQ: 2	AVX 13 x 1300 TM
				ALT	UNTIL MTR-NO: 837405; MTR-CODE: OM 353.950; MOD: 1217 A;1217 AK; REQ: 2	AVX 13 x 1000 TM
				S-PUL	FROM MTR-NO: 837406; MTR-CODE: OM 353.950; MOD: 1217 A;1217 AK; REQ: 2	AVX 13 x 1125 TM
				W-P	MTR-CODE: OM 353.950; MOD: 1217 A;1217 AK; REQ: 2; - MTR-CODE: OM 353.970	AVX 13 x 1325 TM
		OM 353.950;OM 353.951;OM 353.953		AC-C	MTR-CODE: OM 353.950;OM 353.953; OE-NO.: 0099976592; MOD: 1217 A;1217 AK; REQ: 2	AVX 13 x 1350 TM
				AC-C	MTR-CODE: OM 353.950;OM 353.970; OE-NO.: 0099976592; MOD: 1217 A;1217 AK; REQ: 2	AVX 13 x 1350 TM
				AIR-C	MTR-CODE: OM 353.950; MOD: 1217 A;1217 AK; REQ: 2; - MTR-CODE: OM 353.970	AVX 13 x 1325 TM
				AIR-C	MTR-CODE: OM 353.950;OM 353.970; MOD: 1217 A;1217 AK	AVX 13 x 1025 TM
				ALT	MTR-CODE: OM 353.950; MOD: 1217 A;1217 AK; REQ: 2	AVX 13 x 1350 TM
				ALT	MTR-CODE: OM 353.950;OM 353.970; OE-NO.: 0099977692; MOD: 1217 A;1217 AK; REQ: 2	AVX 13 x 1300 TM
				ALT	UNTIL MTR-NO: 837405; MTR-CODE: OM 353.950; MOD: 1217 A;1217 AK; REQ: 2	AVX 13 x 1000 TM
				S-PUL	FROM MTR-NO: 837406; MTR-CODE: OM 353.950; MOD: 1217 A;1217 AK; REQ: 2	AVX 13 x 1125 TM
				W-P	MTR-CODE: OM 353.950; MOD: 1217 A;1217 AK; REQ: 2; - MTR-CODE: OM 353.970	AVX 13 x 1325 TM



## MERCEDES-BENZ

### NG

#### 1219

9570 ccm	141 kW	OM 401.905	09.75 - 12.84	ALT	MOD: 1219;1219 A;1219 AK	AVX 13 x 1475 TM
		OM 401.905;OM 401.906		ALT	MTR-CODE: OM 401.905; MOD: 1219;1219 A;1219 AK	AVX 13 x 1475 TM
		OM 401.914;OM 401.915		ALT	MTR-CODE: OM 401.905; MOD: 1219;1219 A;1219 AK	AVX 13 x 1475 TM
		OM 401.918		ALT	MOD: 1219 AF;1219 F; REQ: 2	AVX 13 x 1525 TM
		OM 401.919		ALT	MTR-CODE: OM 401.918; MOD: 1219 AF;1219 F; REQ: 2	AVX 13 x 1525 TM

#### 1222

10964 ccm	159 kW	OM 421.905	05.82 - 12.91	AIR-C	MOD: 1222;1222 A;1222 AF	AVX 13 x 1350 TM
				ALT	FROM MTR-NO: 130033; MOD: 1222;1222 A;1222 AF	AVX 13 x 1575 TM
				ALT	UNTIL MTR-NO: 130032; MOD: 1222;1222 A;1222 AF	AVX 13 x 1525 TM
		OM 421.905;OM 421.909		HYD-P	MOD: 1222;1222 A;1222 AF; REQ: 3	AVX 13 x 1375 TM
				AIR-C	MTR-CODE: OM 421.905; MOD: 1222;1222 A;1222 AF	AVX 13 x 1350 TM
		OM 421.906		ALT	FROM MTR-NO: 130033; MTR-CODE: OM 421.905; MOD: 1222;1222 A;1222 AF	AVX 13 x 1575 TM
				ALT	UNTIL MTR-NO: 130032; MTR-CODE: OM 421.905; MOD: 1222;1222 A;1222 AF	AVX 13 x 1525 TM
				HYD-P	MTR-CODE: OM 421.905; MOD: 1222;1222 A;1222 AF; REQ: 3	AVX 13 x 1375 TM
				AIR-C	MTR-CODE: OM 421.905; MOD: 1222;1222 A;1222 AF	AVX 13 x 1350 TM
				ALT	FROM MTR-NO: 130033; MTR-CODE: OM 421.905; MOD: 1222;1222 A;1222 AF	AVX 13 x 1575 TM
				ALT	UNTIL MTR-NO: 130032; MTR-CODE: OM 421.905; MOD: 1222;1222 A;1222 AF	AVX 13 x 1525 TM
				HYD-P	MTR-CODE: OM 421.905; MOD: 1222;1222 A;1222 AF; REQ: 3	AVX 13 x 1375 TM
				HYD-P	MTR-CODE: OM 421.905; MOD: 1222;1222 A;1222 AF; REQ: 3	AVX 13 x 1375 TM

#### 1414

5960 ccm	100 kW	OM 366.906;OM 366.909	04.84 - 03.91	AIR-C	MTR-CODE: OM 366.906; MOD: 1414;1414 K; REQ: 2	AVX 13 x 1025 TM
				HYD-P	FROM MTR-NO: 937629; MTR-CODE: OM 366.906; MOD: 1414;1414 K; REQ: 2	AVX 13 x 1375 TM
				PS	MTR-CODE: OM 366.906; MOD: 1414;1414 K	AVX 13 x 925 TM
				W-P	UNTIL MTR-NO: 937628; MTR-CODE: OM 366.906; MOD: 1414;1414 K; REQ: 2	AVX 13 x 1325 TM

#### 1417

5960 ccm	125 kW	OM 366.951;OM 366.952	05.75 - 03.91	AIR-C	FROM MTR-NO: 937629; MTR-CODE: OM 366.951; MOD: 1417 C;1417 CA; REQ: 2	AVX 13 x 1350 TM
				AIR-C	MTR-CODE: OM 366.951; MOD: 1417 C;1417 CA; REQ: 2	AVX 13 x 1025 TM
				ALT	UNTIL MTR-NO: 937628; MTR-CODE: OM 366.951; MOD: 1417 C;1417 CA; REQ: 2	AVX 13 x 1300 TM
				PS	MTR-CODE: OM 366.951; MOD: 1417 C;1417 CA	AVX 13 x 925 TM

#### 1419

5700 ccm	141 kW	OM 362.906;OM 362.909	08.73 - 09.96	AIR-C	MTR-CODE: OM 362.906; MOD: 1419 C;1419 CL; REQ: 2	AVX 13 x 1025 TM
				ALT	MTR-CODE: OM 362.906; MOD: 1419 C;1419 CL; REQ: 2	AVX 13 x 1300 TM
9570 ccm		OM 401.905		PS	MTR-CODE: OM 362.906; MOD: 1419 C;1419 CL	AVX 13 x 925 TM
				ALT	MOD: 1419 AK;1419 AS	AVX 13 x 1475 TM
		ALT		MTR-CODE: OM 401.905;OM401919; MOD: 1419 AK;1419 AS; REQ: 2	AVX 13 x 1525 TM	
		OM 401.914		ALT	MTR-CODE: OM 401.905; MOD: 1419 AK;1419 AS	AVX 13 x 1475 TM
				ALT	MTR-CODE: OM 401.905;OM401919; MOD: 1419 AK;1419 AS; REQ: 2	AVX 13 x 1525 TM
		OM 401.914;OM 401.919		ALT	MTR-CODE: OM 401.905; MOD: 1419 AK;1419 AS	AVX 13 x 1475 TM
ALT	MTR-CODE: OM 401.905;OM401919; MOD: 1419 AK;1419 AS; REQ: 2	AVX 13 x 1525 TM				

#### 1420

5958 ccm	150 kW	OM 366.983	08.73 - 09.96	AIR-C	OE-NO.: 0099976992; MOD: 1420;1420 L; REQ: 2	AVX 13 x 1025 TM
				ALT	FROM MTR-NO: 937629; MOD: 1420;1420 L; REQ: 2	AVX 13 x 1350 TM
				ALT	UNTIL MTR-NO: 937628; MOD: 1420;1420 L; REQ: 2	AVX 13 x 1300 TM

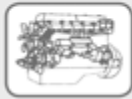

## MERCEDES-BENZ

### NG

#### 1420

5958 ccm	150 kW	OM 366.983	08.73 - 09.96	PS AIR-C	MOD: 1420;1420 L MTR-CODE: OM 366.983; MOD: NG;1420;1420 L; OE-NO.: 0139971692	AVX 13 x 925 TM 10 PK 1005 TM
----------	--------	------------	---------------	-------------	---	----------------------------------

#### 1422

10964 ccm	159 kW	OM 421.905	08.73 - 09.96	AIR-C	MOD: 1422 F	AVX 13 x 1350 TM
10900 ccm				AIR-C	MTR-CODE: OM 401.905; MOD: 1422 F	AVX 13 x 1350 TM
10964 ccm				ALT	FROM MTR-NO: 632565; UNTIL MTR-NO: 712353; MOD: 1422 F	AVX 13 x 1525 TM
10900 ccm				ALT	FROM MTR-NO: 632565; UNTIL MTR-NO: 712353; MTR-CODE: OM 401.905; MOD: 1422 F	AVX 13 x 1525 TM
				ALT	FROM MTR-NO: 712354; MTR-CODE: OM 401.905; MOD: 1422 F	AVX 13 x 1575 TM
10964 ccm				ALT	FROM MTR-NO: 712354; MTR-CODE: OM 401.905; MOD: 1422 F	AVX 13 x 1575 TM
				ALT	UNTIL MTR-NO: 632564; MTR-CODE: OM 401.905; MOD: 1422 F	AVX 13 x 1575 TM
10900 ccm				ALT	UNTIL MTR-NO: 632564; MTR-CODE: OM 401.905; MOD: 1422 F	AVX 13 x 1575 TM
10964 ccm				HYD-P	MOD: 1422 F; REQ: 3	AVX 13 x 1375 TM
10900 ccm				HYD-P	MTR-CODE: OM 401.905; MOD: 1422 F; REQ: 3	AVX 13 x 1375 TM
		OM 421.906		AIR-C	MTR-CODE: OM 401.905; MOD: 1422 F	AVX 13 x 1350 TM
				ALT	FROM MTR-NO: 632565; UNTIL MTR-NO: 712353; MTR-CODE: OM 401.905; MOD: 1422 F	AVX 13 x 1525 TM
				ALT	FROM MTR-NO: 712354; MTR-CODE: OM 401.905; MOD: 1422 F	AVX 13 x 1575 TM
				ALT	UNTIL MTR-NO: 632564; MTR-CODE: OM 401.905; MOD: 1422 F	AVX 13 x 1575 TM
				HYD-P	MTR-CODE: OM 401.905; MOD: 1422 F; REQ: 3	AVX 13 x 1375 TM

#### 1424

12800 ccm	176 kW	OM 402.910;OM 402.911	08.73 - 09.96	ALT	FROM MTR-NO: 191534; MTR-CODE: OM 402.910; MOD: 1424 F;1424 K	AVX 13 x 1525 TM
				ALT	UNTIL MTR-NO: 191533; MTR-CODE: OM 402.910; MOD: 1424 F;1424 K	AVX 13 x 1475 TM
		OM 402.919		ALT	FROM MTR-NO: 191534; MTR-CODE: OM 402.910; MOD: 1424 F;1424 K	AVX 13 x 1525 TM
				ALT	UNTIL MTR-NO: 191533; MTR-CODE: OM 402.910; MOD: 1424 F;1424 K	AVX 13 x 1475 TM

#### 1425

14600 ccm	184 kW	OM 422.909	08.73 - 09.96	ALT	OE-NO.: 0039973092; MOD: 1425 S;1425 LS	AVX 13 x 1525 TM
				ALT	OE-NO.: 0059972792; MOD: 1425 S;1425 LS	AVX 13 x 1550 TM

#### 1614

5960 ccm	100 kW	OM 366.906	04.84 - 03.91	AIR-C	MOD: 1614;1614 K; REQ: 2	AVX 13 x 1025 TM
				ALT	FROM MTR-NO: 937629; MOD: 1614;1614 K; REQ: 2	AVX 13 x 1375 TM
				ALT	UNTIL MTR-NO: 937628; MOD: 1614;1614 K; REQ: 2	AVX 13 x 1325 TM
				PS	MOD: 1614;1614 K	AVX 13 x 925 TM
		OM 366.909		AIR-C	MTR-CODE: OM 366.906; MOD: 1614;1614 K; REQ: 2	AVX 13 x 1025 TM
				ALT	FROM MTR-NO: 937629; MTR-CODE: OM 366.906; MOD: 1614;1614 K; REQ: 2	AVX 13 x 1375 TM
				ALT	UNTIL MTR-NO: 937628; MTR-CODE: OM 366.906; MOD: 1614;1614 K; REQ: 2	AVX 13 x 1325 TM
				PS	MTR-CODE: OM 366.906; MOD: 1614;1614 K	AVX 13 x 925 TM

#### 1617

5960 ccm	125 kW	OM 366.951	08.73 - 09.96	AIR-C	MOD: 1617 C;1617 CL; REQ: 2	AVX 13 x 1025 TM
				ALT	FROM MTR-NO: 937629; MOD: 1617 C;1617 CL; REQ: 2	AVX 13 x 1250 TM
				ALT	UNTIL MTR-NO: 937628; MOD: 1617 C;1617 CL; REQ: 2	AVX 13 x 1300 TM
				PS	MOD: 1617 C;1617 CL	AVX 13 x 925 TM
		OM 366.951;OM 366.952		AIR-C	MTR-CODE: OM 366.951; MOD: 1617 C;1617 CL; REQ: 2	AVX 13 x 1025 TM
				ALT	FROM MTR-NO: 937629; MTR-CODE: OM 366.951; MOD: 1617 C;1617 CL; REQ: 2	AVX 13 x 1250 TM
				ALT	UNTIL MTR-NO: 937628; MTR-CODE: OM 366.951; MOD: 1617 C;1617 CL; REQ: 2	AVX 13 x 1300 TM
				PS	MTR-CODE: OM 366.951; MOD: 1617 C;1617 CL	AVX 13 x 925 TM

#### 1619

5700 ccm	141 kW	OM 362.906;OM 362.909	08.73 - 09.96	AIR-C	MTR-CODE: OM 362.906; MOD: 1619 C;1619 CL; REQ: 2	AVX 13 x 1025 TM
----------	--------	-----------------------	---------------	-------	---	------------------

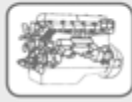

## MERCEDES-BENZ

NG						
<b>1619</b>						
5700 ccm	141 kW	OM 362.906;OM 362.909	08.73 - 09.96	ALT	MTR-CODE: OM 362.906; MOD: 1619 C;1619 CL; REQ: 2	AVX 13 x 1300 TM
9570 ccm		OM 401.905 OM 401.905;OM 401.914		PS ALT ALT	MTR-CODE: OM 362.906; MOD: 1619 C;1619 CL MOD: 1619 AK;1619 K MTR-CODE: OM 401.905; MOD: 1619 AK;1619 K	AVX 13 x 925 TM AVX 13 x 1475 TM AVX 13 x 1475 TM
<b>1620</b>						
5958 ccm	150 kW	OM 366.983	08.73 - 09.96	AIR-C ALT ALT PS AIR-C	OE-NO.: 0099976992; MOD: 1620;1620 L; REQ: 2 FROM MTR-NO: 937629; MOD: 1620;1620 L; REQ: 2 UNTIL MTR-NO: 937628; MOD: 1620;1620 L; REQ: 2 MOD: 1620;1620 L MOD: NG;1620;1620 L; OE-NO.: 0139971692	AVX 13 x 1025 TM AVX 13 x 1350 TM AVX 13 x 1300 TM AVX 13 x 925 TM 10 PK 1005 TM
<b>1622</b>						
10964 ccm	150-159 kW	OM 421.905;OM 441.906;OM 441.907	08.73 - 09.96	AIR-C ALT ALT HYD-P AIR-C ALT ALT HYD-P	MTR-CODE: OM 421.905; MOD: 1622 AK;1622 K FROM MTR-NO: 130033; MTR-CODE: OM 421.905; MOD: 1622 AK;1622 K UNTIL MTR-NO: 130032; MTR-CODE: OM 421.905; MOD: 1622 AK;1622 K MTR-CODE: OM 421.905; MOD: 1622 AK;1622 K; REQ: 3 MOD: 1622 AK;1622 K FROM MTR-NO: 130033; MOD: 1622 AK;1622 K UNTIL MTR-NO: 130032; MOD: 1622 AK;1622 K MOD: 1622 AK;1622 K; REQ: 3	AVX 13 x 1350 TM AVX 13 x 1575 TM AVX 13 x 1525 TM AVX 13 x 1375 TM AVX 13 x 1350 TM AVX 13 x 1575 TM AVX 13 x 1525 TM AVX 13 x 1375 TM
	159 kW	OM 421.905		AIR-C ALT ALT HYD-P	MOD: 1622 AK;1622 K FROM MTR-NO: 130033; MOD: 1622 AK;1622 K UNTIL MTR-NO: 130032; MOD: 1622 AK;1622 K MOD: 1622 AK;1622 K; REQ: 3	AVX 13 x 1350 TM AVX 13 x 1575 TM AVX 13 x 1525 TM AVX 13 x 1375 TM
<b>1624</b>						
12800 ccm	176 kW	OM 402.910	08.73 - 09.96	ALT ALT ALT ALT ALT ALT	FROM MTR-NO: 191534; MOD: 1624 K UNTIL MTR-NO: 191533; MOD: 1624 K FROM MTR-NO: 191534; MTR-CODE: OM 402.910; MOD: 1624 K UNTIL MTR-NO: 191533; MTR-CODE: OM 402.910; MOD: 1624 K FROM MTR-NO: 191534; MTR-CODE: OM 402.910; MOD: 1624 K UNTIL MTR-NO: 191533; MTR-CODE: OM 402.910; MOD: 1624 K	AVX 13 x 1525 TM AVX 13 x 1475 TM AVX 13 x 1525 TM AVX 13 x 1475 TM AVX 13 x 1525 TM AVX 13 x 1475 TM
		OM 402.911		ALT ALT ALT ALT	FROM MTR-NO: 191534; MTR-CODE: OM 402.910; MOD: 1624 K UNTIL MTR-NO: 191533; MTR-CODE: OM 402.910; MOD: 1624 K FROM MTR-NO: 191534; MTR-CODE: OM 402.910; MOD: 1624 K UNTIL MTR-NO: 191533; MTR-CODE: OM 402.910; MOD: 1624 K	AVX 13 x 1525 TM AVX 13 x 1475 TM AVX 13 x 1525 TM AVX 13 x 1475 TM
		OM 402.911;OM 402.923		ALT ALT	FROM MTR-NO: 191534; MTR-CODE: OM 402.910; MOD: 1624 K UNTIL MTR-NO: 191533; MTR-CODE: OM 402.910; MOD: 1624 K	AVX 13 x 1525 TM AVX 13 x 1475 TM
<b>1625</b>						
14600 ccm	184 kW	OM 422.909	08.73 - 09.96	ALT ALT	OE-NO.: 0039973092; MOD: 1625 AK;1625 K OE-NO.: 0059972792; MOD: 1625 AK;1625 K	AVX 13 x 1525 TM AVX 13 x 1550 TM
<b>1626</b>						
12800 ccm	188 kW	OM 402.906 OM 402.906;OM 402.912	08.73 - 09.96	ALT ALT ALT ALT	MOD: 1626 AK;1626 AS MTR-CODE: OM 402.906; MOD: 1626 AK;1626 AS MTR-CODE: OM 402.906; MOD: 1626 AK;1626 AS MTR-CODE: OM 402.906; MOD: 1626 AK;1626 AS	AVX 13 x 1475 TM AVX 13 x 1475 TM AVX 13 x 1475 TM AVX 13 x 1475 TM
		OM 402.906;OM 402.912;OM 402.916 OM 402.912		ALT ALT	MTR-CODE: OM 402.906; MOD: 1626 AK;1626 AS MTR-CODE: OM 402.906; MOD: 1626 AK;1626 AS	AVX 13 x 1475 TM AVX 13 x 1475 TM
<b>1628</b>						
14618 ccm	206 kW	OM 422.905;OM 422.906;OM 422.911	08.73 - 09.96	AIR-C ALT ALT HYD-P AIR-C ALT ALT HYD-P	MTR-CODE: OM 422.905; MOD: 1628 A FROM MTR-NO: 130031; MTR-CODE: OM 422.905; MOD: 1628 A UNTIL MTR-NO: 130030; MTR-CODE: OM 422.905; MOD: 1628 A MTR-CODE: OM 422.905; MOD: 1628 A; REQ: 3 MTR-CODE: OM 422.905; MOD: 1628 A FROM MTR-NO: 130031; MTR-CODE: OM 422.905; MOD: 1628 A UNTIL MTR-NO: 130030; MTR-CODE: OM 422.905; MOD: 1628 A MTR-CODE: OM 422.905; MOD: 1628 A; REQ: 3	AVX 13 x 1350 TM AVX 13 x 1575 TM AVX 13 x 1525 TM AVX 13 x 1375 TM AVX 13 x 1350 TM AVX 13 x 1575 TM AVX 13 x 1525 TM AVX 13 x 1375 TM
		OM 422.905;OM 422.906;OM 422.911;OM 422.913		ALT ALT HYD-P	FROM MTR-NO: 130031; MTR-CODE: OM 422.905; MOD: 1628 A UNTIL MTR-NO: 130030; MTR-CODE: OM 422.905; MOD: 1628 A MTR-CODE: OM 422.905; MOD: 1628 A; REQ: 3	AVX 13 x 1575 TM AVX 13 x 1525 TM AVX 13 x 1375 TM
<b>1633</b>						
14600 ccm	243 kW	OM 422.952;OM 422.954;OM 422.956;OM 422.957;OM 422.958	08.73 - 09.96	AIR-C ALT	MTR-CODE: OM 422.952; MOD: 1633 S;1633 LS FROM MTR-NO: 130033; MTR-CODE: OM 422.952; MOD: 1633 S;1633 LS	AVX 13 x 1350 TM AVX 13 x 1575 TM

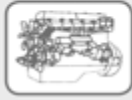

## MERCEDES-BENZ

### NG

#### 1633

14600 ccm	243 kW	OM 422.952;OM 422.954;OM 422.956;OM 422.957;OM 422.958	08.73 - 09.96	ALT	UNTIL MTR-NO: 130032; MTR-CODE: OM 422.952; MOD: 1633 S;1633 LS	AVX 13 x 1525 TM
				FAN	MTR-CODE: OM 422.952; MOD: 1633 S;1633 LS; REQ: 2	AVX 13 x 1200 TM
				HYD-P	MTR-CODE: OM 422.952; MOD: 1633 S;1633 LS; REQ: 3	AVX 13 x 1375 TM

#### 1636

18273 ccm	261 kW	OM 423.905;OM 423.908	08.73 - 09.96	AIR-C	MTR-CODE: OM 423.905; MOD: 1636 S;1636 LS	AVX 13 x 1350 TM
				ALT	FROM MTR-NO: 130033; MTR-CODE: OM 423.905; MOD: 1636 S;1636 LS	AVX 13 x 1575 TM
				ALT	UNTIL MTR-NO: 130032; MTR-CODE: OM 423.905; MOD: 1636 S;1636 LS	AVX 13 x 1525 TM
				HYD-P	MTR-CODE: OM 423.905; MOD: 1636 S;1636 LS	AVX 13 x 1375 TM

#### 1638

14620 ccm	276 kW	OM 422.953;OM 422.955;OM 422.959	08.73 - 09.96	ALT	FROM MTR-NO: 130033; MTR-CODE: OM 422.953; MOD: 1638;1638 S;1638 LS	AVX 13 x 1550 TM
				ALT	UNTIL MTR-NO: 130032; MTR-CODE: OM 422.953; MOD: 1638;1638 S;1638 LS	AVX 13 x 1525 TM
				FAN	MTR-CODE: OM 422.953; MOD: 1638;1638 S;1638 LS; REQ: 2	AVX 13 x 1200 TM

#### 1644

14618 ccm	320 kW	OM 442.951;OM 442.953;OM 442.980	08.73 - 09.96	ALT	FROM MTR-NO: 632565; UNTIL MTR-NO: 712353; MTR-CODE: OM 442.951; MOD: 1644;1644 S;1644 LS	AVX 13 x 1525 TM
				ALT	FROM MTR-NO: 712354; MTR-CODE: OM 442.951; MOD: 1644;1644 S;1644 LS	AVX 13 x 1575 TM
				ALT	UNTIL MTR-NO: 632564; MTR-CODE: OM 442.951; MOD: 1644;1644 S;1644 LS	AVX 13 x 1575 TM

#### 1719

9570 ccm	141 kW	OM 401.909	09.73 - 08.82	ALT	MTR-CODE: OM 401.909;OM401916; MOD: 1719;1719 AK;1719 K	AVX 13 x 1475 TM
		OM 401.909;OM 401.916		ALT	MTR-CODE: OM 401.909;OM401916; MOD: 1719;1719 AK;1719 K	AVX 13 x 1475 TM

#### 1919

9570 ccm	141 kW	OM 401.909	05.74 - 08.82	ALT	MTR-CODE: OM 401.909;OM401916; MOD: 1919;1919 AK;1919 K	AVX 13 x 1475 TM
		OM 401.909;OM 401.916		ALT	MTR-CODE: OM 401.909;OM401916; MOD: 1919;1919 AK;1919 K	AVX 13 x 1475 TM

#### 1922

10964 ccm	159 kW	OM 421.905	10.81 - 03.91	AIR-C	MOD: 1922;1922 AK;1922 K	AVX 13 x 1350 TM
				ALT	FROM MTR-NO: 130033; MOD: 1922;1922 AK;1922 K	AVX 13 x 1575 TM
				ALT	UNTIL MTR-NO: 130032; MOD: 1922;1922 AK;1922 K	AVX 13 x 1525 TM
				HYD-P	MOD: 1922;1922 AK;1922 K; REQ: 3	AVX 13 x 1375 TM

#### 1928

14620 ccm	206 kW	OM 422.905;OM 422.906;OM 422.907;OM 422.911;OM 422.913	08.73 - 09.96	AIR-C	MTR-CODE: OM 422.905; MOD: 1928 A;1928 AK	AVX 13 x 1350 TM
				ALT	FROM MTR-NO: 130031; MTR-CODE: OM 422.905; MOD: 1928 A;1928 AK	AVX 13 x 1575 TM
				ALT	UNTIL MTR-NO: 130030; MTR-CODE: OM 422.905; MOD: 1928 A;1928 AK	AVX 13 x 1525 TM
				HYD-P	MTR-CODE: OM 422.905; MOD: 1928 A;1928 AK; REQ: 3	AVX 13 x 1375 TM
		OM 422.905;OM 422.907;OM 422.911;OM 422.913		AIR-C	MTR-CODE: OM 422.905; MOD: 1928 A;1928 AK	AVX 13 x 1350 TM
				ALT	FROM MTR-NO: 130031; MTR-CODE: OM 422.905; MOD: 1928 A;1928 AK	AVX 13 x 1575 TM
				ALT	UNTIL MTR-NO: 130030; MTR-CODE: OM 422.905; MOD: 1928 A;1928 AK	AVX 13 x 1525 TM
				HYD-P	MTR-CODE: OM 422.905; MOD: 1928 A;1928 AK; REQ: 3	AVX 13 x 1375 TM
		OM 422.906;OM 422.911		AIR-C	MTR-CODE: OM 422.905; MOD: 1928 A;1928 AK	AVX 13 x 1350 TM
				ALT	FROM MTR-NO: 130031; MTR-CODE: OM 422.905; MOD: 1928 A;1928 AK	AVX 13 x 1575 TM
				ALT	UNTIL MTR-NO: 130030; MTR-CODE: OM 422.905; MOD: 1928 A;1928 AK	AVX 13 x 1525 TM
				HYD-P	MTR-CODE: OM 422.905; MOD: 1928 A;1928 AK; REQ: 3	AVX 13 x 1375 TM



## MERCEDES-BENZ

### NG

#### 1928

14620 ccm	206 kW	OM 422.913	08.73 - 09.96	AIR-C	MTR-CODE: OM 422.905; MOD: 1928 A;1928 AK	AVX 13 x 1350 TM
				ALT	FROM MTR-NO: 130031; MTR-CODE: OM 422.905; MOD: 1928 A;1928 AK	AVX 13 x 1575 TM
				ALT	UNTIL MTR-NO: 130030; MTR-CODE: OM 422.905; MOD: 1928 A;1928 AK	AVX 13 x 1525 TM
				HYD-P	MTR-CODE: OM 422.905; MOD: 1928 A;1928 AK; REQ: 3	AVX 13 x 1375 TM

#### 1933

14620 ccm	243 kW	OM 422.952;OM 422.954;OM 422.956;OM 422.957;OM 422.958	08.73 - 09.96	AIR-C	MTR-CODE: OM 422.952; MOD: 1933;1933 S;1933 LS	AVX 13 x 1350 TM
				ALT	FROM MTR-NO: 130033; MTR-CODE: OM 422.952; MOD: 1933;1933 S;1933 LS	AVX 13 x 1575 TM
				ALT	UNTIL MTR-NO: 130032; MTR-CODE: OM 422.952; MOD: 1933;1933 S;1933 LS	AVX 13 x 1525 TM
				FAN	MTR-CODE: OM 422.952; MOD: 1933;1933 S;1933 LS; REQ: 2	AVX 13 x 1200 TM
				HYD-P	MTR-CODE: OM 422.952; MOD: 1933;1933 S;1933 LS; REQ: 3	AVX 13 x 1375 TM

#### 1935

14618 ccm	260 kW	OM 442.950;OM 442.952	08.73 - 09.96	ALT	FROM MTR-NO: 632565; UNTIL MTR-NO: 712353; MTR-CODE: OM 442.950; MOD: 1935;1935 AK	AVX 13 x 1525 TM
				ALT	UNTIL MTR-NO: 632564; MTR-CODE: OM 442.950; MOD: 1935;1935 AK	AVX 13 x 1550 TM
				FAN	FROM MTR-NO: 712354; MTR-CODE: OM 442.950; MOD: 1935;1935 AK	AVX 13 x 1550 TM
	260-269 kW	OM 442.962		ALT	FROM MTR-NO: 632565; UNTIL MTR-NO: 712353; MTR-CODE: OM 442.950; MOD: 1935;1935 AK	AVX 13 x 1525 TM
				ALT	UNTIL MTR-NO: 632564; MTR-CODE: OM 442.950; MOD: 1935;1935 AK	AVX 13 x 1550 TM
				FAN	FROM MTR-NO: 712354; MTR-CODE: OM 442.950; MOD: 1935;1935 AK	AVX 13 x 1550 TM

#### 1936

18273 ccm	261 kW	OM 423.905	08.73 - 09.96	AIR-C	MOD: 1936;1936 AK	AVX 13 x 1350 TM
				ALT	FROM MTR-NO: 130033; MOD: 1936;1936 AK	AVX 13 x 1575 TM
				ALT	UNTIL MTR-NO: 130032; MOD: 1936;1936 AK	AVX 13 x 1525 TM
				HYD-P	MOD: 1936;1936 AK	AVX 13 x 1375 TM
		OM 423.905;OM 423.906;OM 423.907		AIR-C	MTR-CODE: OM 423.905; MOD: 1936;1936 AK	AVX 13 x 1350 TM
				ALT	FROM MTR-NO: 130033; MTR-CODE: OM 423.905; MOD: 1936;1936 AK	AVX 13 x 1575 TM
				ALT	UNTIL MTR-NO: 130032; MTR-CODE: OM 423.905; MOD: 1936;1936 AK	AVX 13 x 1525 TM
				HYD-P	MTR-CODE: OM 423.905; MOD: 1936;1936 AK	AVX 13 x 1375 TM
		OM 423.905;OM 423.906;OM 423.908		AIR-C	MTR-CODE: OM 423.905; MOD: 1936;1936 AK	AVX 13 x 1350 TM
				ALT	FROM MTR-NO: 130033; MTR-CODE: OM 423.905; MOD: 1936;1936 AK	AVX 13 x 1575 TM
				ALT	UNTIL MTR-NO: 130032; MTR-CODE: OM 423.905; MOD: 1936;1936 AK	AVX 13 x 1525 TM
				HYD-P	MTR-CODE: OM 423.905; MOD: 1936;1936 AK	AVX 13 x 1375 TM
		OM 423.908		AIR-C	MTR-CODE: OM 423.905; MOD: 1936;1936 AK	AVX 13 x 1350 TM
				ALT	FROM MTR-NO: 130033; MTR-CODE: OM 423.905; MOD: 1936;1936 AK	AVX 13 x 1575 TM
				ALT	UNTIL MTR-NO: 130032; MTR-CODE: OM 423.905; MOD: 1936;1936 AK	AVX 13 x 1525 TM
				HYD-P	MTR-CODE: OM 423.905; MOD: 1936;1936 AK	AVX 13 x 1375 TM

#### 1938

14618 ccm	276 kW	OM 422.953;OM 422.955;OM 422.959	08.73 - 09.96	ALT	FROM MTR-NO: 130033; MTR-CODE: OM 422.906; MOD: 1938;1938 S;1938 LS	AVX 13 x 1550 TM
				ALT	UNTIL MTR-NO: 130032; MTR-CODE: OM 422.906; MOD: 1938;1938 S;1938 LS	AVX 13 x 1525 TM
				FAN	MTR-CODE: OM 422.906; MOD: 1938;1938 S;1938 LS; REQ: 2	AVX 13 x 1200 TM
14600 ccm		OM 422.953;OM 422.959		ALT	FROM MTR-NO: 130033; MTR-CODE: OM 422.906; MOD: 1938;1938 S;1938 LS	AVX 13 x 1550 TM
				ALT	UNTIL MTR-NO: 130032; MTR-CODE: OM 422.906; MOD: 1938;1938 S;1938 LS	AVX 13 x 1525 TM
				FAN	MTR-CODE: OM 422.906; MOD: 1938;1938 S;1938 LS; REQ: 2	AVX 13 x 1200 TM



## MERCEDES-BENZ

### NG

#### 1944

14618 ccm	320 kW	OM 442.951	08.73 - 09.96	ALT	FROM MTR-NO: 632565; UNTIL MTR-NO: 712353; MOD: 1944;1944 S;1944 LS	AVX 13 x 1525 TM
				ALT	FROM MTR-NO: 712354; MTR-CODE: OM 442.951; MOD: 1944;1944 S;1944 LS	AVX 13 x 1575 TM
				ALT	UNTIL MTR-NO: 632564; MTR-CODE: OM 442.951; MOD: 1944;1944 S;1944 LS	AVX 13 x 1575 TM

#### 2025

14600 ccm	184 kW	OM 422.909	08.83 - 03.91	ALT	OE-NO.: 0039973092; MOD: 2025 S	AVX 13 x 1525 TM
				ALT	OE-NO.: 0059972792; MOD: 2025 S	AVX 13 x 1550 TM

#### 2028

14618 ccm	206 kW	OM 422.905;OM 422.906;OM 422.910;OM 422.911	01.80 - 06.89	AIR-C	MTR-CODE: OM 422.905; MOD: 2028 LS	AVX 13 x 1350 TM
				ALT	FROM MTR-NO: 130031; MTR-CODE: OM 422.905; MOD: 2028 LS	AVX 13 x 1575 TM
				ALT	UNTIL MTR-NO: 130030; MTR-CODE: OM 422.905; MOD: 2028 LS	AVX 13 x 1525 TM
				HYD-P	MTR-CODE: OM 422.905; MOD: 2028 LS; REQ: 3	AVX 13 x 1375 TM

#### 2033

14600 ccm	243 kW	OM 422.952;OM 422.956	12.81 - 05.87	AIR-C	MTR-CODE: OM 422.952; MOD: 2033 LS	AVX 13 x 1350 TM
				ALT	FROM MTR-NO: 130033; MTR-CODE: OM 422.952; MOD: 2033 LS	AVX 13 x 1575 TM
				ALT	UNTIL MTR-NO: 130032; MTR-CODE: OM 422.952; MOD: 2033 LS	AVX 13 x 1525 TM
				FAN	MTR-CODE: OM 422.952; MOD: 2033 LS; REQ: 2	AVX 13 x 1200 TM
				HYD-P	MTR-CODE: OM 422.952; MOD: 2033 LS; REQ: 3	AVX 13 x 1375 TM

#### 2036

18300 ccm	261 kW	OM 423.905;OM 423.908	01.80 - 03.91	AIR-C	MTR-CODE: OM 423.905; MOD: 2036 LS	AVX 13 x 1350 TM
				ALT	FROM MTR-NO: 130033; MTR-CODE: OM 423.905; MOD: 2036 LS	AVX 13 x 1575 TM
				ALT	UNTIL MTR-NO: 130032; MTR-CODE: OM 423.905; MOD: 2036 LS	AVX 13 x 1525 TM
				HYD-P	MTR-CODE: OM 423.905; MOD: 2036 LS	AVX 13 x 1375 TM

#### 2219

5700 ccm	141 kW	OM 362.906;OM 362.909	08.73 - 09.96	ALT	MTR-CODE: OM 362.906; MOD: 2219 C;2219 CL	AVX 13 x 1475 TM
9570 ccm		OM 401.914;OM 401.926		ALT	MTR-CODE: OM 401.914; MOD: 2219;2219 K;2219 KO	AVX 13 x 1475 TM
		OM 401.923;OM 401.926;OM 401.927		ALT	MTR-CODE: OM 401.914; MOD: 2219;2219 K;2219 KO	AVX 13 x 1475 TM
		OM 401.925		ALT	MTR-CODE: OM 401.914; MOD: 2219;2219 K;2219 KO	AVX 13 x 1475 TM
		OM 401.926		ALT	MTR-CODE: OM 401.914; MOD: 2219;2219 K;2219 KO	AVX 13 x 1475 TM

#### 2220

5958 ccm	150 kW	OM 366.983	08.73 - 09.96	AIR-C	OE-NO.: 0099976992; MOD: 2220;2220 L; REQ: 2	AVX 13 x 1025 TM
				ALT	FROM MTR-NO: 937629; MOD: 2220;2220 L; REQ: 2	AVX 13 x 1350 TM
				ALT	UNTIL MTR-NO: 937628; MOD: 2220;2220 L; REQ: 2	AVX 13 x 1300 TM
				PS	MOD: 2220;2220 L	AVX 13 x 925 TM
				AIR-C	MOD: NG;2220;2220 L; OE-NO.: 0139971692	10 PK 1005 TM

#### 2222

10964 ccm	150-159 kW	OM 421.905;OM 421.907;OM 441.906	08.73 - 09.96	ALT	FROM MTR-NO: 130033; MTR-CODE: OM 421.905;OM421905;OM421907; MOD: 2222;2222 B;2222 K	AVX 13 x 1575 TM
				ALT	MTR-CODE: OM 421.905;OM421905;OM421907; MOD: 2222;2222 B;2222 K	AVX 13 x 1350 TM
				ALT	MTR-CODE: OM 421.905;OM441906; MOD: 2222;2222 B;2222 K	AVX 13 x 1550 TM
				ALT	UNTIL MTR-NO: 130032; MTR-CODE: OM 421.905;OM421905;OM421907; MOD: 2222;2222 B;2222 K	AVX 13 x 1525 TM
				HYD-P	MTR-CODE: OM 421.905;OM421905;OM421907; MOD: 2222;2222 B;2222 K; REQ: 3	AVX 13 x 1375 TM
	159 kW	OM 421.905		ALT	FROM MTR-NO: 130033; MTR-CODE: OM 421.905;OM421905;OM421907; MOD: 2222;2222 B;2222 K	AVX 13 x 1575 TM



## MERCEDES-BENZ

### NG

#### 2222

10964 ccm	159 kW	OM 421.905	08.73 - 09.96	ALT	MTR-CODE: OM 421.905;OM421905;OM421907; MOD: 2222;2222 B;2222 K	AVX 13 x 1350 TM
				ALT	MTR-CODE: OM 421.905;OM441906; MOD: 2222;2222 B;2222 K	AVX 13 x 1550 TM
				ALT	UNTIL MTR-NO: 130032; MTR-CODE: OM 421.905;OM421905;OM421907; MOD: 2222;2222 B;2222 K	AVX 13 x 1525 TM
				HYD-P	MTR-CODE: OM 421.905;OM421905;OM421907; MOD: 2222;2222 B;2222 K; REQ: 3	AVX 13 x 1375 TM

#### 2224

12800 ccm	176 kW	OM 402.910;OM 402.927	05.75 - 03.84	ALT	FROM MTR-NO: 191534; MTR-CODE: OM 402.910; MOD: 1624 K	AVX 13 x 1525 TM
				ALT	UNTIL MTR-NO: 191533; MTR-CODE: OM 402.910; MOD: 1624 K	AVX 13 x 1475 TM
		OM 402.911;OM 402.928		ALT	FROM MTR-NO: 191534; MTR-CODE: OM 402.910; MOD: 1624 K	AVX 13 x 1525 TM
				ALT	UNTIL MTR-NO: 191533; MTR-CODE: OM 402.910; MOD: 1624 K	AVX 13 x 1475 TM
		OM 402.914		ALT	FROM MTR-NO: 191534; MTR-CODE: OM 402.910; MOD: 1624 K	AVX 13 x 1525 TM
				ALT	UNTIL MTR-NO: 191533; MTR-CODE: OM 402.910; MOD: 1624 K	AVX 13 x 1475 TM

#### 2225

14618 ccm	184 kW	OM 422.909	08.73 - 09.96	ALT	OE-NO.: 0039973092; MOD: 2225;2225 B	AVX 13 x 1525 TM
				ALT	OE-NO.: 0059972792; MOD: 2225;2225 B	AVX 13 x 1550 TM
		OM 422.912		ALT	MTR-CODE: OM 422.909; OE-NO.: 0039973092; MOD: 2225;2225 B	AVX 13 x 1525 TM
				ALT	MTR-CODE: OM 422.909; OE-NO.: 0059972792; MOD: 2225;2225 B	AVX 13 x 1550 TM

#### 2228

14618 ccm	206 kW	OM 422.905;OM 422.906;OM 422.911	08.73 - 09.96	AIR-C	MTR-CODE: OM 422.905; MOD: 2228;2228 S	AVX 13 x 1350 TM
				ALT	FROM MTR-NO: 130031; MTR-CODE: OM 422.905; MOD: 2228;2228 S	AVX 13 x 1575 TM
				ALT	UNTIL MTR-NO: 130030; MTR-CODE: OM 422.905; MOD: 2228;2228 S	AVX 13 x 1525 TM
				HYD-P	MTR-CODE: OM 422.905; MOD: 2228;2228 S; REQ: 3	AVX 13 x 1375 TM
		OM 422.905;OM 422.911		AIR-C	MTR-CODE: OM 422.905; MOD: 2228;2228 S	AVX 13 x 1350 TM
				ALT	FROM MTR-NO: 130031; MTR-CODE: OM 422.905; MOD: 2228;2228 S	AVX 13 x 1575 TM
				ALT	UNTIL MTR-NO: 130030; MTR-CODE: OM 422.905; MOD: 2228;2228 S	AVX 13 x 1525 TM
				HYD-P	MTR-CODE: OM 422.905; MOD: 2228;2228 S; REQ: 3	AVX 13 x 1375 TM

#### 2233

14618 ccm	243 kW	OM 422.952;OM 422.954;OM 422.957	08.73 - 09.96	AIR-C	MTR-CODE: OM 422.952; MOD: 2233;2233 S	AVX 13 x 1350 TM
				ALT	FROM MTR-NO: 130033; MTR-CODE: OM 422.952; MOD: 2233;2233 S	AVX 13 x 1575 TM
				ALT	UNTIL MTR-NO: 130032; MTR-CODE: OM 422.952; MOD: 2233;2233 S	AVX 13 x 1525 TM
				FAN	MTR-CODE: OM 422.952; MOD: 2233;2233 S; REQ: 2	AVX 13 x 1200 TM
				HYD-P	MTR-CODE: OM 422.952; MOD: 2233;2233 S; REQ: 3	AVX 13 x 1375 TM
		OM 422.952;OM 422.954;OM 422.957;OM 422.958		AIR-C	MTR-CODE: OM 422.952; MOD: 2233;2233 S	AVX 13 x 1350 TM
				ALT	FROM MTR-NO: 130033; MTR-CODE: OM 422.952; MOD: 2233;2233 S	AVX 13 x 1575 TM
				ALT	UNTIL MTR-NO: 130032; MTR-CODE: OM 422.952; MOD: 2233;2233 S	AVX 13 x 1525 TM
				FAN	MTR-CODE: OM 422.952; MOD: 2233;2233 S; REQ: 2	AVX 13 x 1200 TM
				HYD-P	MTR-CODE: OM 422.952; MOD: 2233;2233 S; REQ: 3	AVX 13 x 1375 TM
		OM 422.957;OM 422.958		AIR-C	MTR-CODE: OM 422.952; MOD: 2233;2233 S	AVX 13 x 1350 TM
				ALT	FROM MTR-NO: 130033; MTR-CODE: OM 422.952; MOD: 2233;2233 S	AVX 13 x 1575 TM
				ALT	UNTIL MTR-NO: 130032; MTR-CODE: OM 422.952; MOD: 2233;2233 S	AVX 13 x 1525 TM



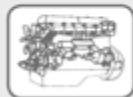

## MERCEDES-BENZ

### NG

#### 2233

14618 ccm	243 kW	OM 422.957;OM 422.958	08.73 - 09.96	FAN	MTR-CODE: OM 422.952; MOD: 2233;2233 S; REQ: 2	AVX 13 x 1200 TM
				HYD-P	MTR-CODE: OM 422.952; MOD: 2233;2233 S; REQ: 3	AVX 13 x 1375 TM

#### 2236

18273 ccm	261 kW	OM 423.905;OM 423.908	09.82 - 03.91	AIR-C	MTR-CODE: OM 423.905; MOD: 2236;2236 S	AVX 13 x 1350 TM
				ALT	FROM MTR-NO: 130033; MTR-CODE: OM 423.905; MOD: 2236;2236 S	AVX 13 x 1575 TM
				ALT	UNTIL MTR-NO: 130032; MTR-CODE: OM 423.905; MOD: 2236;2236 S	AVX 13 x 1525 TM
				HYD-P	MTR-CODE: OM 423.905; MOD: 2236;2236 S	AVX 13 x 1375 TM

#### 2238

14618 ccm	276 kW	OM 422.953;OM 422.955;OM 422.959	08.73 - 09.96	ALT	FROM MTR-NO: 130033; MTR-CODE: OM 422.953; MOD: 2238 S;2238;2238 L	AVX 13 x 1550 TM
				ALT	UNTIL MTR-NO: 130032; MTR-CODE: OM 422.953; MOD: 2238 S;2238;2238 L	AVX 13 x 1525 TM
				FAN	MTR-CODE: OM 422.953; MOD: 2238 S;2238;2238 L; REQ: 2	AVX 13 x 1200 TM

#### 2244

14618 ccm	320 kW	OM 442.951	08.73 - 09.96	ALT	FROM MTR-NO: 632565; UNTIL MTR-NO: 712353; MOD: 2244 S;2244;2244 L	AVX 13 x 1525 TM
				ALT	FROM MTR-NO: 712354; MTR-CODE: OM 442.951; MOD: 2244 S;2244;2244 L	AVX 13 x 1575 TM
				ALT	UNTIL MTR-NO: 632564; MTR-CODE: OM 442.951; MOD: 2244 S;2244;2244 L	AVX 13 x 1575 TM
		OM 442.951;OM 442.953;OM 442.980		ALT	FROM MTR-NO: 632565; UNTIL MTR-NO: 712353; MTR-CODE: OM 442.951; MOD: 2244 S;2244;2244 L	AVX 13 x 1525 TM
				ALT	FROM MTR-NO: 712354; MTR-CODE: OM 442.951; MOD: 2244 S;2244;2244 L	AVX 13 x 1575 TM
				ALT	UNTIL MTR-NO: 632564; MTR-CODE: OM 442.951; MOD: 2244 S;2244;2244 L	AVX 13 x 1575 TM

#### 2628

14618 ccm	206 kW	OM 422.905;OM 422.911	02.80 - 03.91	AIR-C	MTR-CODE: OM 422.905; MOD: 2628;2628 A;2628 AK	AVX 13 x 1350 TM
				ALT	FROM MTR-NO: 130031; MTR-CODE: OM 422.905; MOD: 2628;2628 A;2628 AK	AVX 13 x 1575 TM
				ALT	UNTIL MTR-NO: 130030; MTR-CODE: OM 422.905; MOD: 2628;2628 A;2628 AK	AVX 13 x 1525 TM
				HYD-P	MTR-CODE: OM 422.905; MOD: 2628;2628 A;2628 AK; REQ: 3	AVX 13 x 1375 TM
		OM 422.907;OM 422.913		AIR-C	MTR-CODE: OM 422.905; MOD: 2628;2628 A;2628 AK	AVX 13 x 1350 TM
				ALT	FROM MTR-NO: 130031; MTR-CODE: OM 422.905; MOD: 2628;2628 A;2628 AK	AVX 13 x 1575 TM
				ALT	UNTIL MTR-NO: 130030; MTR-CODE: OM 422.905; MOD: 2628;2628 A;2628 AK	AVX 13 x 1525 TM
				HYD-P	MTR-CODE: OM 422.905; MOD: 2628;2628 A;2628 AK; REQ: 3	AVX 13 x 1375 TM
		OM 422.907;OM 422.913;OM 422.916		AIR-C	MTR-CODE: OM 422.905; MOD: 2628;2628 A;2628 AK	AVX 13 x 1350 TM
				ALT	FROM MTR-NO: 130031; MTR-CODE: OM 422.905; MOD: 2628;2628 A;2628 AK	AVX 13 x 1575 TM
				ALT	UNTIL MTR-NO: 130030; MTR-CODE: OM 422.905; MOD: 2628;2628 A;2628 AK	AVX 13 x 1525 TM
				HYD-P	MTR-CODE: OM 422.905; MOD: 2628;2628 A;2628 AK; REQ: 3	AVX 13 x 1375 TM
		OM 422.913		AIR-C	MTR-CODE: OM 422.905; MOD: 2628;2628 A;2628 AK	AVX 13 x 1350 TM
				ALT	FROM MTR-NO: 130031; MTR-CODE: OM 422.905; MOD: 2628;2628 A;2628 AK	AVX 13 x 1575 TM
				ALT	UNTIL MTR-NO: 130030; MTR-CODE: OM 422.905; MOD: 2628;2628 A;2628 AK	AVX 13 x 1525 TM
				HYD-P	MTR-CODE: OM 422.905; MOD: 2628;2628 A;2628 AK; REQ: 3	AVX 13 x 1375 TM
18270 ccm	331 kW	OM 443.940		ALT	FROM MTR-NO: 632565; MOD: 2628 A	AVX 13 x 1525 TM
				ALT	UNTIL MTR-NO: 632564; MOD: 2628 A	AVX 13 x 1550 TM

#### 2633

14620 ccm	243 kW	OM 422.952;OM 422.954;OM 422.956	05.82 - 05.87	AIR-C	MTR-CODE: OM 422.952; MOD: 2633;2633 S	AVX 13 x 1350 TM
				ALT	FROM MTR-NO: 130033; MTR-CODE: OM 422.952; MOD: 2633;2633 S	AVX 13 x 1575 TM



## MERCEDES-BENZ

### NG

#### 2633

14620 ccm	243 kW	OM 422.952;OM 422.954;OM 422.956	05.82 - 05.87	ALT	UNTIL MTR-NO: 130032; MTR-CODE: OM 422.952; MOD: 2633;2633 S	AVX 13 x 1525 TM
				FAN	MTR-CODE: OM 422.952; MOD: 2633;2633 S; REQ: 2	AVX 13 x 1200 TM
				HYD-P	MTR-CODE: OM 422.952; MOD: 2633;2633 S; REQ: 3	AVX 13 x 1375 TM
		OM 422.952;OM 422.954;OM 422.957		AIR-C	MTR-CODE: OM 422.952; MOD: 2633;2633 S	AVX 13 x 1350 TM
				ALT	FROM MTR-NO: 130033; MTR-CODE: OM 422.952; MOD: 2633;2633 S	AVX 13 x 1575 TM
				ALT	UNTIL MTR-NO: 130032; MTR-CODE: OM 422.952; MOD: 2633;2633 S	AVX 13 x 1525 TM
				FAN	MTR-CODE: OM 422.952; MOD: 2633;2633 S; REQ: 2	AVX 13 x 1200 TM
				HYD-P	MTR-CODE: OM 422.952; MOD: 2633;2633 S; REQ: 3	AVX 13 x 1375 TM

#### 2636

18273 ccm	261 kW	OM 423.905	11.81 - 03.91	AIR-C	MOD: 2636;2636 A;2636 AK	AVX 13 x 1350 TM
				ALT	FROM MTR-NO: 130033; MOD: 2636;2636 A;2636 AK	AVX 13 x 1575 TM
				ALT	UNTIL MTR-NO: 130032; MOD: 2636;2636 A;2636 AK	AVX 13 x 1525 TM
				HYD-P	MOD: 2636;2636 A;2636 AK	AVX 13 x 1375 TM
		OM 423.907		AIR-C	MTR-CODE: OM 423.905; MOD: 2636;2636 A;2636 AK	AVX 13 x 1350 TM
				ALT	FROM MTR-NO: 130033; MTR-CODE: OM 423.905; MOD: 2636;2636 A;2636 AK	AVX 13 x 1575 TM
				ALT	UNTIL MTR-NO: 130032; MTR-CODE: OM 423.905; MOD: 2636;2636 A;2636 AK	AVX 13 x 1525 TM
				HYD-P	MTR-CODE: OM 423.905; MOD: 2636;2636 A;2636 AK	AVX 13 x 1375 TM

#### 2638

14600 ccm	276 kW	OM 422.953;OM 422.955	01.81 - 12.86	ALT	FROM MTR-NO: 130033; MTR-CODE: OM 422.953; MOD: 2638 S	AVX 13 x 1550 TM
				ALT	UNTIL MTR-NO: 130032; MTR-CODE: OM 422.953; MOD: 2638 S	AVX 13 x 1525 TM
				FAN	MTR-CODE: OM 422.953; MOD: 2638 S; REQ: 2	AVX 13 x 1200 TM

#### 2644

14618 ccm	320 kW	OM 442.953;OM 442.980	08.73 - 09.96	ALT	FROM MTR-NO: 632565; UNTIL MTR-NO: 712353; MTR-CODE: OM 442.953; MOD: 2644 S	AVX 13 x 1525 TM
				ALT	FROM MTR-NO: 712354; MTR-CODE: OM 442.953; MOD: 2644 S	AVX 13 x 1575 TM
				ALT	UNTIL MTR-NO: 632564; MTR-CODE: OM 442.953; MOD: 2644 S	AVX 13 x 1575 TM

#### 3025

14618 ccm	184-206 kW	OM 422.919;OM 422.920	08.83 - 03.91	ALT	MTR-CODE: OM 422.919;OM 422.920; OE-NO.: 0039973092; MOD: 3025 B;3025 K	AVX 13 x 1525 TM
				ALT	MTR-CODE: OM 422.919;OM 422.920; OE-NO.: 0059972792; MOD: 3025 B;3025 K	AVX 13 x 1550 TM
	184 kW	OM 422.920		ALT	MTR-CODE: OM 422.919;OM 422.920; OE-NO.: 0039973092; MOD: 3025 B;3025 K	AVX 13 x 1525 TM
				ALT	MTR-CODE: OM 422.919;OM 422.920; OE-NO.: 0059972792; MOD: 3025 B;3025 K	AVX 13 x 1550 TM

#### 3028

14618 ccm	206 kW	OM 422.905;OM 422.911	02.80 - 03.91	AIR-C	MTR-CODE: OM 422.905; MOD: 3028;3028 B;3028 K	AVX 13 x 1350 TM
				ALT	FROM MTR-NO: 130031; MTR-CODE: OM 422.905; MOD: 3028;3028 B;3028 K	AVX 13 x 1575 TM
				ALT	UNTIL MTR-NO: 130030; MTR-CODE: OM 422.905; MOD: 3028;3028 B;3028 K	AVX 13 x 1525 TM
				HYD-P	MTR-CODE: OM 422.905; MOD: 3028;3028 B;3028 K; REQ: 3	AVX 13 x 1375 TM
		OM 422.919		AIR-C	MTR-CODE: OM 422.905; MOD: 3028;3028 B;3028 K	AVX 13 x 1350 TM
				ALT	FROM MTR-NO: 130031; MTR-CODE: OM 422.905; MOD: 3028;3028 B;3028 K	AVX 13 x 1575 TM
				ALT	UNTIL MTR-NO: 130030; MTR-CODE: OM 422.905; MOD: 3028;3028 B;3028 K	AVX 13 x 1525 TM
				HYD-P	MTR-CODE: OM 422.905; MOD: 3028;3028 B;3028 K; REQ: 3	AVX 13 x 1375 TM

#### 3036

18273 ccm	261 kW	OM 423.905;OM 423.908	11.81 - 03.91	AIR-C	MTR-CODE: OM 423.905; MOD: 3036	AVX 13 x 1350 TM
-----------	--------	-----------------------	---------------	-------	---------------------------------	------------------



## MERCEDES-BENZ

### NG

#### 3036

18273 ccm	261 kW	OM 423.905;OM 423.908	11.81 - 03.91	ALT	FROM MTR-NO: 130033; MTR-CODE: OM 423.905; MOD: 3036	AVX 13 x 1575 TM
				ALT	UNTIL MTR-NO: 130032; MTR-CODE: OM 423.905; MOD: 3036	AVX 13 x 1525 TM
				HYD-P	MTR-CODE: OM 423.905; MOD: 3036	AVX 13 x 1375 TM

#### 3228

14618 ccm	206 kW	OM 422.919;OM 422.921	07.87 - 03.91	AIR-C	MTR-CODE: OM 422.919; MOD: 3228 B;3228 K	AVX 13 x 1350 TM
				ALT	FROM MTR-NO: 130031; MTR-CODE: OM 422.919; MOD: 3228 B;3228 K	AVX 13 x 1575 TM
				ALT	UNTIL MTR-NO: 130030; MTR-CODE: OM 422.919; MOD: 3228 B;3228 K	AVX 13 x 1525 TM
				HYD-P	MTR-CODE: OM 422.919; MOD: 3228 B;3228 K; REQ: 3	AVX 13 x 1375 TM

#### 3250

18273 ccm	368 kW	OM 423.950;OM 423.951	09.85 - 08.94	ALT	MTR-CODE: OM 423.908; MOD: 3250 A;3250 AF	AVX 13 x 1400 TM
-----------	--------	-----------------------	---------------	-----	---	------------------

#### 3328

14600 ccm	206 kW	OM 422.914;OM 422.919	02.80 - 03.91	AIR-C	MTR-CODE: OM 422.914; MOD: 3328 B;3328 K	AVX 13 x 1350 TM
				ALT	FROM MTR-NO: 130031; MTR-CODE: OM 422.914; MOD: 3328 B;3328 K	AVX 13 x 1575 TM
				ALT	UNTIL MTR-NO: 130030; MTR-CODE: OM 422.914; MOD: 3328 B;3328 K	AVX 13 x 1525 TM
				HYD-P	MTR-CODE: OM 422.914; MOD: 3328 B;3328 K; REQ: 3	AVX 13 x 1375 TM

#### 3333

14618 ccm	243 kW	OM 422.954	12.82 - 11.91	AIR-C	MOD: 3333;3333 B;3333 K	AVX 13 x 1350 TM
				ALT	FROM MTR-NO: 130033; MOD: 3333;3333 B;3333 K	AVX 13 x 1575 TM
				ALT	UNTIL MTR-NO: 130032; MOD: 3333;3333 B;3333 K	AVX 13 x 1525 TM
				FAN	FROM MTR-NO: 712354; MOD: 3333;3333 B;3333 K; REQ: 2	AVX 13 x 1200 TM
				HYD-P	MOD: 3333;3333 B;3333 K; REQ: 3	AVX 13 x 1375 TM

#### 3336

18373 ccm	261 kW	OM 423.905	11.81 - 11.91	AIR-C	MOD: 3336 K	AVX 13 x 1350 TM
18273 ccm				AIR-C	MOD: 3336;3336 AK;3336 S	AVX 13 x 1350 TM
18373 ccm				ALT	FROM MTR-NO: 130033; MOD: 3336 K	AVX 13 x 1575 TM
18273 ccm				ALT	FROM MTR-NO: 130033; MOD: 3336;3336 AK;3336 S	AVX 13 x 1575 TM
18373 ccm				ALT	UNTIL MTR-NO: 130032; MOD: 3336 K	AVX 13 x 1525 TM
18273 ccm				ALT	UNTIL MTR-NO: 130032; MOD: 3336;3336 AK;3336 S	AVX 13 x 1525 TM
18373 ccm				HYD-P	MOD: 3336 K	AVX 13 x 1375 TM
18273 ccm				HYD-P	MOD: 3336;3336 AK;3336 S	AVX 13 x 1375 TM
		OM 423.905;OM 423.907		AIR-C	MTR-CODE: OM 423.905; MOD: 3336;3336 AK;3336 S	AVX 13 x 1350 TM
				ALT	FROM MTR-NO: 130033; MTR-CODE: OM 423.905; MOD: 3336;3336 AK;3336 S	AVX 13 x 1575 TM
				ALT	UNTIL MTR-NO: 130032; MTR-CODE: OM 423.905; MOD: 3336;3336 AK;3336 S	AVX 13 x 1525 TM
				HYD-P	MTR-CODE: OM 423.905; MOD: 3336;3336 AK;3336 S	AVX 13 x 1375 TM
		OM 423.907		AIR-C	MTR-CODE: OM 423.905; MOD: 3336;3336 AK;3336 S	AVX 13 x 1350 TM
				ALT	FROM MTR-NO: 130033; MTR-CODE: OM 423.905; MOD: 3336;3336 AK;3336 S	AVX 13 x 1575 TM
				ALT	UNTIL MTR-NO: 130032; MTR-CODE: OM 423.905; MOD: 3336;3336 AK;3336 S	AVX 13 x 1525 TM
				HYD-P	MTR-CODE: OM 423.905; MOD: 3336;3336 AK;3336 S	AVX 13 x 1375 TM

#### 3528

14618 ccm	206 kW	OM 422.919	07.82 - 09.89	AIR-C	MOD: 3528 B;3528 K	AVX 13 x 1350 TM
				ALT	FROM MTR-NO: 130031; MOD: 3528 B;3528 K	AVX 13 x 1575 TM
				ALT	UNTIL MTR-NO: 130030; MOD: 3528 B;3528 K	AVX 13 x 1525 TM
				HYD-P	MOD: 3528 B;3528 K; REQ: 3	AVX 13 x 1375 TM

#### 3850

18273 ccm	368 kW	OM 423.950	09.85 - 08.94	ALT	MOD: 3850 A	AVX 13 x 1400 TM
-----------	--------	------------	---------------	-----	-------------	------------------

### O 100

#### City

2874 ccm	72 kW	OM 602.940	01.94 -	ALT	FROM MTR-NO: 253308; MOD: City; + AC; - PS	6 PK 2030
----------	-------	------------	---------	-----	--	-----------



## MERCEDES-BENZ

### O 100

City						
2874 ccm	72 kW	OM 602.940	01.94 -	ALT	FROM MTR-NO: 253308; UNTIL MTR-NO: 340125; MOD: City; - AC; - PS	6 PK 995
				ALT	FROM MTR-NO: 253308; UNTIL MTR-NO: 340125; MOD: City; + PS; - AC	6 PK 1980
				ALT	FROM MTR-NO: 340126; MOD: City; + AC; - PS	6 PK 2050
				ALT	FROM MTR-NO: 340126; MOD: City; + AC; + PS	6 PK 2100
				ALT	FROM MTR-NO: 340126; MOD: City; + PS; - AC	6 PK 2040
				ALT	UNTIL MTR-NO: 253307; MOD: City; + AC; - PS	6 PK 2030
				ALT	UNTIL MTR-NO: 253307; MOD: City; + PS; - AC	6 PK 2000
				ALT	UNTIL MTR-NO: 253307; MTR-CODE: OM602.940; MOD: City; - AC; - PS	6 PK 1015 TM
				ALT	UNTIL MTR-NO: 340125; MOD: City; + AC; - PS	6 PK 2030
				ALT	UNTIL MTR-NO: 340125; MOD: City; + AC; + PS	6 PK 2080
				W-P	FROM MTR-NO: 340126; MTR-CODE: OM602.940; MOD: City; - AC; - PS	6 PK 1015 TM

### O 340

#### Tourismo

12763 ccm	280 kW	OM 402.984;OM 402.995	08.92 - 08.95	ALT	MTR-CODE: OM 402.984; MOD: Turismo	AVX 13 x 950 TM
				ALT	MTR-CODE: OM402.984; MOD: Turismo	9 PK 4100 TM

### O 404

#### 404

11300 ccm	151 kW	OM 441.922	09.91 - 10.99	2. ALT	MTR-CODE: OM 401.970; MOD: O 404	AVX 13 x 950 TM
				AC-C		2-SPB 2100 TM
				AC-C		3-SPB 2100 TM
				ALT	MTR-CODE: OM401.970; OE-NO.: 0089977792; MOD: O404	9 PK 4100 TM
				ALT	MTR-CODE: OM401.970; OE-NO.: 0109970992; MOD: O404	9 PK 4145 TM
				ALT	MTR-CODE: OM401.970; OE-NO.: 4768010000; MOD: O404	9 PK 4145 TM
				ALT	MTR-CODE: OM401.970; OE-NO.: 4768017000; MOD: O404	9 PK 4100 TM
	165 kW	OM 441.921		2. ALT	MTR-CODE: OM 401.970; MOD: O 404	AVX 13 x 950 TM
				AC-C		2-SPB 2100 TM
				AC-C		3-SPB 2100 TM
				ALT	MTR-CODE: OM401.970; OE-NO.: 0089977792; MOD: O404	9 PK 4100 TM
				ALT	MTR-CODE: OM401.970; OE-NO.: 0109970992; MOD: O404	9 PK 4145 TM
				ALT	MTR-CODE: OM401.970; OE-NO.: 4768010000; MOD: O404	9 PK 4145 TM
				ALT	MTR-CODE: OM401.970; OE-NO.: 4768017000; MOD: O404	9 PK 4100 TM
15100 ccm	195 kW	OM 442.931		2. ALT	MTR-CODE: OM 401.970; MOD: O 404	AVX 13 x 950 TM
				AC-C		2-SPB 2100 TM
				AC-C		3-SPB 2100 TM
				ALT	MTR-CODE: OM401.970; OE-NO.: 0089977792; MOD: O404	9 PK 4100 TM
				ALT	MTR-CODE: OM401.970; OE-NO.: 0109970992; MOD: O404	9 PK 4145 TM
				ALT	MTR-CODE: OM401.970; OE-NO.: 4768010000; MOD: O404	9 PK 4145 TM
				ALT	MTR-CODE: OM401.970; OE-NO.: 4768017000; MOD: O404	9 PK 4100 TM
9800 ccm	200 kW	OM 401.974		2. ALT	MTR-CODE: OM 401.970; MOD: O 404	AVX 13 x 950 TM
9572 ccm				2. ALT	MTR-CODE: OM 401.970; MOD: O 404	AVX 13 x 950 TM
				AC-C		2-SPB 2100 TM
9800 ccm				AC-C		2-SPB 2100 TM
9572 ccm				AC-C		3-SPB 2100 TM
9800 ccm				AC-C		3-SPB 2100 TM
9572 ccm				ALT	MTR-CODE: OM401.970; OE-NO.: 0089977792; MOD: O404	9 PK 4100 TM
				ALT	MTR-CODE: OM401.970; OE-NO.: 0109970992; MOD: O404	9 PK 4145 TM
9800 ccm				ALT	MTR-CODE: OM401.970; OE-NO.: 0109970992; MOD: O404	9 PK 4145 TM
9572 ccm				ALT	MTR-CODE: OM401.970; OE-NO.: 4768010000; MOD: O404	9 PK 4145 TM
9800 ccm				ALT	MTR-CODE: OM401.970; OE-NO.: 4768010000; MOD: O404	9 PK 4145 TM

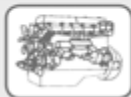

## MERCEDES-BENZ

### O 404

ccm	kW	OM	Year	Code	MTR-CODE	OE-NO.	Accessories
9800	200	OM 401.974	09.91 - 10.99	ALT	MTR-CODE: OM401.970; MOD: O404	4768017000;	9 PK 4100 TM
9572				ALT	MTR-CODE: OM401.970; MOD: O404	4768017000;	9 PK 4100 TM
9800				W-P	MTR-CODE: OM401.970; MOD: O404	0089977792;	9 PK 4100 TM
9572	213	OM 401.970		2. ALT	MOD: O 404		AVX 13 x 950 TM
				AC-C			2-SPB 2100 TM
				AC-C			3-SPB 2100 TM
				ALT	OE-NO.: 0089977792; MOD: O404		9 PK 4100 TM
				ALT	OE-NO.: 0109970992; MOD: O404		9 PK 4145 TM
				ALT	OE-NO.: 4768010000; MOD: O404		9 PK 4145 TM
				ALT	OE-NO.: 4768017000; MOD: O404		9 PK 4100 TM
15100		OM 442.930		2. ALT	MTR-CODE: OM 401.970; MOD: O 404		AVX 13 x 950 TM
				AC-C			2-SPB 2100 TM
				AC-C			3-SPB 2100 TM
				ALT	MTR-CODE: OM401.970; OE-NO.: 0089977792; MOD: O404		9 PK 4100 TM
				ALT	MTR-CODE: OM401.970; OE-NO.: 0109970992; MOD: O404		9 PK 4145 TM
				ALT	MTR-CODE: OM401.970; OE-NO.: 4768010000; MOD: O404		9 PK 4145 TM
				ALT	MTR-CODE: OM401.970; OE-NO.: 4768017000; MOD: O404		9 PK 4100 TM
10964		OM 445.935		AC-C			2-SPB 2100 TM
				AC-C			3-SPB 2100 TM
	250	OM 441.980;OM 445.934		2. ALT	MTR-CODE: OM 401.970; MOD: O 404		AVX 13 x 950 TM
				AC-C			2-SPB 2100 TM
				AC-C			3-SPB 2100 TM
				ALT	MTR-CODE: OM401.970; OE-NO.: 0089977792; MOD: O404		9 PK 4100 TM
				ALT	MTR-CODE: OM401.970; OE-NO.: 0109970992; MOD: O404		9 PK 4145 TM
				ALT	MTR-CODE: OM401.970; OE-NO.: 4768010000; MOD: O404		9 PK 4145 TM
				ALT	MTR-CODE: OM401.970; OE-NO.: 4768017000; MOD: O404		9 PK 4100 TM
12763	280	OM 402.970		2. ALT	MTR-CODE: OM 401.970; MOD: O 404		AVX 13 x 950 TM
				AC-C			2-SPB 2100 TM
				AC-C			3-SPB 2100 TM
				ALT	MTR-CODE: OM401.970; OE-NO.: 0089977792; MOD: O404		9 PK 4100 TM
				ALT	MTR-CODE: OM401.970; OE-NO.: 0109970992; MOD: O404		9 PK 4145 TM
				ALT	MTR-CODE: OM401.970; OE-NO.: 4768010000; MOD: O404		9 PK 4145 TM
				ALT	MTR-CODE: OM401.970; OE-NO.: 4768017000; MOD: O404		9 PK 4100 TM
14618		OM 446.934;OM 446.938		AC-C			2-SPB 2100 TM
				AC-C			3-SPB 2100 TM
		OM 446.938		AC-C			2-SPB 2100 TM
				AC-C			3-SPB 2100 TM

### O 405

#### 405

11967	150-157	OM 427.905;OM 447.905;OM 447.911;OM 447.913;OM 447.914;OM 447.970;OM 447.973	12.84 -	AIR-C	MTR-CODE: OM 427.905; MOD: O 405 ST		AVX 13 x 1550 TM
				ALT	MTR-CODE: OM 427.905; MOD: O 405 ST		AVX 13 x 1325 TM
				ALT	MTR-CODE: OM 427.905;OM 447; MOD: O 405 ST		AVX 13 x 1125 TM
				FAN	MTR-CODE: OM 427.905; MOD: O 405 ST; REQ: 2		AVX 13 x 1150 TM
				G-PUL	MTR-CODE: OM 427.905; OE-NO.: 0059973092; MOD: O 405 ST		AVX 13 x 1700 TM
				G-PUL	MTR-CODE: OM 427.905; OE-NO.: 0059974192; MOD: O 405 ST		AVX 13 x 1750 TM
				W-P	MTR-CODE: OM 427.905;OM 447; MOD: O 405 ST		AVX 13 x 1200 TM
				W-P	MTR-CODE: OM 427.905;OM 447; MOD: O 405 ST; REQ: 2		AVX 13 x 1250 TM



## MERCEDES-BENZ

### O 405

405						
11967 ccm	177-184 kW	OM 427.910;OM 427.911;OM 447.907;OM 447.908;OM 447.910;OM 447.956;OM 447.957;OM 447.971;OM 447.974	12.84 -	AIR-C	MTR-CODE: OM 427.905; MOD: O 405 ST	AVX 13 x 1550 TM
				ALT	MTR-CODE: OM 427.905; MOD: O 405 ST	AVX 13 x 1325 TM
				ALT	MTR-CODE: OM 427.905;OM 447; MOD: O 405 ST	AVX 13 x 1125 TM
				FAN	MTR-CODE: OM 427.905; MOD: O 405 ST; REQ: 2	AVX 13 x 1150 TM
				G-PUL	MTR-CODE: OM 427.905; OE-NO.: 0059973092; MOD: O 405 ST	AVX 13 x 1700 TM
				G-PUL	MTR-CODE: OM 427.905; OE-NO.: 0059974192; MOD: O 405 ST	AVX 13 x 1750 TM
				W-P	MTR-CODE: OM 427.905;OM 447; MOD: O 405 ST	AVX 13 x 1200 TM
				W-P	MTR-CODE: OM 427.905;OM 447; MOD: O 405 ST; REQ: 2	AVX 13 x 1250 TM
		OM 427.911;OM 447.907;OM 447.955;OM 447.959;OM 447.976;OM 447.978		ALT	MTR-CODE: OM 427.911; REQ: 2	AVX 13 x 1200 TM
				ALT	MTR-CODE: OM 427.911;OM 447.959; REQ: 2	AVX 13 x 1200 TM
				FAN	MTR-CODE: OM 427.911; REQ: 2	AVX 13 x 1150 TM
				FAN	MTR-CODE: OM 427.911;OM 447.959; REQ: 2	AVX 13 x 1450 TM
				G-PUL	MTR-CODE: OM 427.911; REQ: 2	AVX 13 x 1750 TM
				G-PUL	MTR-CODE: OM 427.911;OM 447.959; REQ: 2	AVP 13 x 2450 TM
				W-P	MTR-CODE: OM 427.911	AVX 13 x 1250 TM
				W-P	MTR-CODE: OM 427.911;OM 447.907; REQ: 2	AVX 13 x 1250 TM
				W-P	MTR-CODE: OM 427.911;OM 447.959; REQ: 2	AVX 13 x 1250 TM
206 kW		OM 427.950;OM 447.950		ALT	MTR-CODE: OM 427.950; MOD: O 405 G;O 405 GTD; REQ: 2	AVX 13 x 1200 TM
				ALT	MTR-CODE: OM 427.950;OM 447.950; MOD: O 405 G;O 405 GTD	AVX 13 x 1200 TM
				FAN	MTR-CODE: OM 427.950; MOD: O 405 G;O 405 GTD; REQ: 2	AVX 13 x 1150 TM
				G-PUL	MTR-CODE: OM 427.950; MOD: O 405 G;O 405 GTD	AVX 13 x 1700 TM
				W-P	MTR-CODE: OM 427.950; MOD: O 405 G;O 405 GTD	AVX 13 x 1250 TM
		OM 427.950;OM 447.950;OM 447.951		AIR-C	MTR-CODE: OM 427.905; MOD: O 405 ST	AVX 13 x 1550 TM
				ALT	MTR-CODE: OM 427.905; MOD: O 405 ST	AVX 13 x 1325 TM
				ALT	MTR-CODE: OM 427.905;OM 447; MOD: O 405 ST	AVX 13 x 1125 TM
				FAN	MTR-CODE: OM 427.905; MOD: O 405 ST; REQ: 2	AVX 13 x 1150 TM
				G-PUL	MTR-CODE: OM 427.905; OE-NO.: 0059973092; MOD: O 405 ST	AVX 13 x 1700 TM
				G-PUL	MTR-CODE: OM 427.905; OE-NO.: 0059974192; MOD: O 405 ST	AVX 13 x 1750 TM
				W-P	MTR-CODE: OM 427.905;OM 447; MOD: O 405 ST	AVX 13 x 1200 TM
				W-P	MTR-CODE: OM 427.905;OM 447; MOD: O 405 ST; REQ: 2	AVX 13 x 1250 TM
220 kW		OM 447.972;OM 447.975;OM 447.981;OM 447.986		AIR-C	MTR-CODE: OM 427.905; MOD: O 405 ST	AVX 13 x 1550 TM
				ALT	MTR-CODE: OM 427.905; MOD: O 405 ST	AVX 13 x 1325 TM
				ALT	MTR-CODE: OM 427.905;OM 447; MOD: O 405 ST	AVX 13 x 1125 TM
				FAN	MTR-CODE: OM 427.905; MOD: O 405 ST; REQ: 2	AVX 13 x 1150 TM
				G-PUL	MTR-CODE: OM 427.905; OE-NO.: 0059973092; MOD: O 405 ST	AVX 13 x 1700 TM
				G-PUL	MTR-CODE: OM 427.905; OE-NO.: 0059974192; MOD: O 405 ST	AVX 13 x 1750 TM
				W-P	MTR-CODE: OM 427.905;OM 447; MOD: O 405 ST	AVX 13 x 1200 TM
				W-P	MTR-CODE: OM 427.905;OM 447; MOD: O 405 ST; REQ: 2	AVX 13 x 1250 TM

### O 407

407						
11967 ccm	177-184 kW	OM 447.906;OM 447.908;OM 447.954;OM 447.990	03.87 - 11.01	ALT	MTR-CODE: OM 447.906; MOD: O 407	AVX 13 x 1200 TM



## MERCEDES-BENZ

### O 407

#### 407

11967 ccm	177-184 kW	OM 447.906;OM 447.908;OM 447.954;OM 447.990	03.87 - 11.01	FAN	MTR-CODE: OM 447.906; MOD: O 407	<b>AVX 13 x 1125 TM</b>
	220 kW	OM 447.985;OM 447.991		W-P	MTR-CODE: OM 447.906; MOD: O 407; REQ: 2	<b>AVX 13 x 1250 TM</b>
				ALT	MTR-CODE: OM 447.906; MOD: O 407	<b>AVX 13 x 1200 TM</b>
				FAN	MTR-CODE: OM 447.906; MOD: O 407	<b>AVX 13 x 1125 TM</b>
				W-P	MTR-CODE: OM 447.906; MOD: O 407; REQ: 2	<b>AVX 13 x 1250 TM</b>

### O 408

#### 408

11967 ccm	184 kW	OM 447.912;OM 447.958;OM 447.992	01.91 - 12.98	ALT	MTR-CODE: OM 447.912; MOD: O 408	<b>AVX 13 x 1200 TM</b>
	220 kW	OM 447.987;OM 447.993		FAN	MTR-CODE: OM 447.912; MOD: O 408	<b>AVX 13 x 1125 TM</b>
				W-P	MTR-CODE: OM 447.912; MOD: O 408; REQ: 2	<b>AVX 13 x 1250 TM</b>
				ALT	MTR-CODE: OM 447.912; MOD: O 408	<b>AVX 13 x 1200 TM</b>
				FAN	MTR-CODE: OM 447.912; MOD: O 408	<b>AVX 13 x 1125 TM</b>
				W-P	MTR-CODE: OM 447.912; MOD: O 408; REQ: 2	<b>AVX 13 x 1250 TM</b>

### SK

#### 1728; 1729

15080 ccm	210-218 kW	OM 442.906;OM 442.907;OM 442.908;OM 442.923;OM 442.925	07.87 - 09.96	AIR-C	MTR-CODE: OM 442.906; MOD: 1729 AK;1729 K	<b>AVX 13 x 1350 TM</b>
				ALT	FROM MTR-NO: 632565; UNTIL MTR-NO: 712353; MTR-CODE: OM 442.906; MOD: 1729 AK;1729 K	<b>AVX 13 x 1525 TM</b>
				ALT	FROM MTR-NO: 712354; MTR-CODE: OM 442.906; MOD: 1729 AK;1729 K	<b>AVX 13 x 1575 TM</b>
				ALT	UNTIL MTR-NO: 632564; MTR-CODE: OM 442.906; MOD: 1729 AK;1729 K	<b>AVX 13 x 1575 TM</b>
				HYD-P	MTR-CODE: OM 442.906; MOD: 1729 AK;1729 K; REQ: 3	<b>AVX 13 x 1375 TM</b>

#### 1729

15080 ccm	210-218 kW	OM 442.906;OM 442.907;OM 442.923;OM 442.925	07.87 - 09.96	AIR-C	MTR-CODE: OM 442.906; MOD: 1729 AK;1729 K	<b>AVX 13 x 1350 TM</b>
				ALT	FROM MTR-NO: 632565; UNTIL MTR-NO: 712353; MTR-CODE: OM 442.906; MOD: 1729 AK;1729 K	<b>AVX 13 x 1525 TM</b>
				ALT	FROM MTR-NO: 712354; MTR-CODE: OM 442.906; MOD: 1729 AK;1729 K	<b>AVX 13 x 1575 TM</b>
				ALT	UNTIL MTR-NO: 632564; MTR-CODE: OM 442.906; MOD: 1729 AK;1729 K	<b>AVX 13 x 1575 TM</b>
				HYD-P	MTR-CODE: OM 442.906; MOD: 1729 AK;1729 K; REQ: 3	<b>AVX 13 x 1375 TM</b>
	213-218 kW	OM 442.906;OM 442.907;OM 442.925		AIR-C	MTR-CODE: OM 442.906; MOD: 1729 AK;1729 K	<b>AVX 13 x 1350 TM</b>
				ALT	FROM MTR-NO: 632565; UNTIL MTR-NO: 712353; MTR-CODE: OM 442.906; MOD: 1729 AK;1729 K	<b>AVX 13 x 1525 TM</b>
				ALT	FROM MTR-NO: 712354; MTR-CODE: OM 442.906; MOD: 1729 AK;1729 K	<b>AVX 13 x 1575 TM</b>
				ALT	UNTIL MTR-NO: 632564; MTR-CODE: OM 442.906; MOD: 1729 AK;1729 K	<b>AVX 13 x 1575 TM</b>
				HYD-P	MTR-CODE: OM 442.906; MOD: 1729 AK;1729 K; REQ: 3	<b>AVX 13 x 1375 TM</b>
	213 kW	OM 442.907;OM 442.926		AIR-C	MTR-CODE: OM 442.906; MOD: 1729 AK;1729 K	<b>AVX 13 x 1350 TM</b>
				ALT	FROM MTR-NO: 632565; UNTIL MTR-NO: 712353; MTR-CODE: OM 442.906; MOD: 1729 AK;1729 K	<b>AVX 13 x 1525 TM</b>
				ALT	FROM MTR-NO: 712354; MTR-CODE: OM 442.906; MOD: 1729 AK;1729 K	<b>AVX 13 x 1575 TM</b>
				ALT	UNTIL MTR-NO: 632564; MTR-CODE: OM 442.906; MOD: 1729 AK;1729 K	<b>AVX 13 x 1575 TM</b>
				HYD-P	MTR-CODE: OM 442.906; MOD: 1729 AK;1729 K; REQ: 3	<b>AVX 13 x 1375 TM</b>

#### 1735

14618 ccm	218 kW	OM 442.906	07.87 - 09.96	ALT	FROM MTR-NO: 632565; UNTIL MTR-NO: 712353; MOD: 1735 AK;1735 L	<b>AVX 13 x 1525 TM</b>
				ALT	UNTIL MTR-NO: 632564; MTR-CODE: OM 442.906; MOD: 1735 AK;1735 L	<b>AVX 13 x 1550 TM</b>
				FAN	FROM MTR-NO: 712354; MTR-CODE: OM 442.906; MOD: 1735 AK;1735 L	<b>AVX 13 x 1550 TM</b>



## MERCEDES-BENZ

### SK

#### 1735

14618 ccm	250-269 kW	OM 440.940;OM 442.944;OM 442.963;OM 442.964;OM 442.976	07.87 - 09.96	AIR-C	MTR-CODE: OM 440;OM 440.940; MOD: 1735 K	AVX 13 x 1350 TM
				ALT	FROM MTR-NO: 712354; MTR-CODE: OM 440;OM 440.940; MOD: 1735 K	AVX 13 x 1575 TM
				ALT	UNTIL MTR-NO: 712353; MTR-CODE: OM 440;OM 440.940; MOD: 1735 K	AVX 13 x 1525 TM
	260-269 kW	OM 442.942;OM 442.966		HYD-P	MTR-CODE: OM 440.940; MOD: 1735 K; REQ: 3	AVX 13 x 1375 TM
				ALT	FROM MTR-NO: 632565; UNTIL MTR-NO: 712353; MTR-CODE: OM 442.906; MOD: 1735 AK;1735 L	AVX 13 x 1525 TM
				ALT	UNTIL MTR-NO: 632564; MTR-CODE: OM 442.906; MOD: 1735 AK;1735 L	AVX 13 x 1550 TM
				FAN	FROM MTR-NO: 712354; MTR-CODE: OM 442.906; MOD: 1735 AK;1735 L	AVX 13 x 1550 TM
		OM 442.944;OM 442.963;OM 442.964;OM 442.976		ALT	FROM MTR-NO: 632565; UNTIL MTR-NO: 712353; MTR-CODE: OM 442.906; MOD: 1735 AK;1735 L	AVX 13 x 1525 TM
				ALT	UNTIL MTR-NO: 632564; MTR-CODE: OM 442.906; MOD: 1735 AK;1735 L	AVX 13 x 1550 TM
				FAN	FROM MTR-NO: 712354; MTR-CODE: OM 442.906; MOD: 1735 AK;1735 L	AVX 13 x 1550 TM

#### 1748

14618 ccm	353-362 kW	OM 442.985;OM 442.989	07.87 - 09.96	AIR-C	MTR-CODE: OM 442.985; MOD: 1748 S;1748 LS	AVX 13 x 1350 TM
				ALT	FROM MTR-NO: 632565; UNTIL MTR-NO: 712353; MTR-CODE: OM 442.985; MOD: 1748 S;1748 LS	AVX 13 x 1525 TM
				ALT	FROM MTR-NO: 712354; MTR-CODE: OM 442.985; MOD: 1748 S;1748 LS	AVX 13 x 1575 TM
				ALT	UNTIL MTR-NO: 632564; MTR-CODE: OM 442.985; MOD: 1748 S;1748 LS	AVX 13 x 1575 TM
				HYD-P	MTR-CODE: OM 442.985; MOD: 1748 S;1748 LS; REQ: 3	AVX 13 x 1375 TM

#### 1831

9572 ccm	230 kW	OM 401.972;OM 401.979;OM 401.993	07.87 - 09.96	ALT	FROM MTR-NO: 632565; UNTIL MTR-NO: 712353; MTR-CODE: OM 401.972; MOD: 1831 AK;1831 K	AVX 13 x 1525 TM
				ALT	FROM MTR-NO: 712354; MTR-CODE: OM 401.972; MOD: 1831 AK;1831 K	AVX 13 x 1575 TM
				ALT	UNTIL MTR-NO: 632564; MTR-CODE: OM 401.972; MOD: 1831 AK;1831 K	AVX 13 x 1575 TM
		OM 401.986		ALT	FROM MTR-NO: 632565; UNTIL MTR-NO: 712353; MTR-CODE: OM 401.972; MOD: 1831 AK;1831 K	AVX 13 x 1525 TM
				ALT	FROM MTR-NO: 712354; MTR-CODE: OM 401.972; MOD: 1831 AK;1831 K	AVX 13 x 1575 TM
				ALT	UNTIL MTR-NO: 632564; MTR-CODE: OM 401.972; MOD: 1831 AK;1831 K	AVX 13 x 1575 TM

#### 1834

10964 ccm	250 kW	OM 441.986;OM 441.996;OM 445.920;OM 445.939	07.87 - 09.96	AIR-C	FROM MTR-NO: 712354; MTR-CODE: OM 441.986; MOD: 1834 S;1834 LS; - MTR-CODE: OM 445	AVX 13 x 1350 TM
				ALT	FROM MTR-NO: 632565; UNTIL MTR-NO: 712353; MTR-CODE: OM 441.986; MOD: 1834 S;1834 LS; - MTR-CODE: OM 445	AVX 13 x 1525 TM
				ALT	UNTIL MTR-NO: 632564; MTR-CODE: OM 441.986; MOD: 1834 S;1834 LS; - MTR-CODE: OM 445	AVX 13 x 1550 TM

#### 1838

14618 ccm	280 kW	OM 446.924	07.87 - 09.96	ALT	FROM MTR-NO: 712354; MTR-CODE: OM 440.978; MOD: 1838 AK;1838 K	AVX 13 x 1575 TM
				ALT	UNTIL MTR-NO: 712353; MTR-CODE: OM 440.978; MOD: 1838 AK;1838 K	AVX 13 x 1525 TM
		OM 446.924;OM 446.925		ALT	MTR-CODE: OM 446.924; MOD: 1838 AK	AVX 13 x 1575 TM
		OM 446.927		ALT	MTR-CODE: OM 446.924; MOD: 1838 AK	AVX 13 x 1575 TM
	320 kW	OM 440.978;OM 440.991		ALT	FROM MTR-NO: 712354; MTR-CODE: OM 440.978; MOD: 1838 AK;1838 K	AVX 13 x 1575 TM
				ALT	UNTIL MTR-NO: 712353; MTR-CODE: OM 440.978; MOD: 1838 AK;1838 K	AVX 13 x 1525 TM
		OM 440.978;OM 440.991;OM 446.943		ALT	FROM MTR-NO: 712354; MTR-CODE: OM 440.978; MOD: 1838 AK;1838 K	AVX 13 x 1575 TM
				ALT	UNTIL MTR-NO: 712353; MTR-CODE: OM 440.978; MOD: 1838 AK;1838 K	AVX 13 x 1525 TM



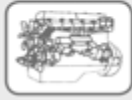

## MERCEDES-BENZ

### SK

#### 1838

14618 ccm	320 kW	OM 440.979	07.87 - 09.96	ALT	FROM MTR-NO: 712354; MTR-CODE: OM 440.978; MOD: 1838 AK;1838 K	AVX 13 x 1575 TM
				ALT	UNTIL MTR-NO: 712353; MTR-CODE: OM 440.978; MOD: 1838 AK;1838 K	AVX 13 x 1525 TM
	370 kW	OM 440.982		ALT	FROM MTR-NO: 712354; MOD: 1838 AK	AVX 13 x 1575 TM
				ALT	UNTIL MTR-NO: 712353; MOD: 1838 AK	AVX 13 x 1525 TM

#### 1844

14618 ccm	320 kW	OM 440.970;OM 440.978;OM 446.922	07.87 - 09.96	ALT	FROM MTR-NO: 712354; MTR-CODE: OM 440.970; MOD: 1844 S;1844 LS	AVX 13 x 1575 TM
				ALT	MTR-CODE: OM 440.970;OM 446.922; MOD: 1844 S;1844 LS	AVX 13 x 1575 TM
				ALT	UNTIL MTR-NO: 712353; MTR-CODE: OM 440.970; MOD: 1844 S;1844 LS	AVX 13 x 1525 TM

#### 1850

14618 ccm	362-370 kW	OM 440.973;OM 442.985;OM 442.989;OM 442.992;OM 442.997	07.87 - 09.96	ALT	FROM MTR-NO: 712354; MTR-CODE: OM 440.973; MOD: 1850 S;1850 LS	AVX 13 x 1575 TM
				ALT	UNTIL MTR-NO: 632564; MTR-CODE: OM 440.973; MOD: 1850 S;1850 LS; - MTR-CODE: OM 440.973	AVX 13 x 1575 TM
				ALT	UNTIL MTR-NO: 712353; MTR-CODE: OM 440.973; MOD: 1850 S;1850 LS	AVX 13 x 1525 TM

#### 1853

14618 ccm	390 kW	OM 446.920 OM 446.920;OM 446.946	07.87 - 09.96	AC-C	MOD: 1853 AK	AVX 13 x 1350 TM
				ALT	MOD: 1853 AK	AVX 13 x 1575 TM
				AC-C	MTR-CODE: OM 446.920; MOD: 1853 AK	AVX 13 x 1350 TM
				ALT	MTR-CODE: OM 446.920; MOD: 1853 AK	AVX 13 x 1575 TM

#### 1922

11310 ccm	160-165 kW	OM 441.905;OM 441.914;OM 441.923 OM 441.914;OM 441.926	05.89 - 08.94	ALT	FROM MTR-NO: 632565; UNTIL MTR-NO: 712353; MTR-CODE: OM 441.905; MOD: 1922;1922 AK;1922 K	AVX 13 x 1525 TM
				ALT	UNTIL MTR-NO: 632564; MTR-CODE: OM 441.905; MOD: 1922;1922 AK;1922 K	AVX 13 x 1550 TM
				FAN	FROM MTR-NO: 712354; MTR-CODE: OM 441.905; MOD: 1922;1922 AK;1922 K	AVX 13 x 1550 TM
				ALT	FROM MTR-NO: 632565; UNTIL MTR-NO: 712353; MTR-CODE: OM 441.905; MOD: 1922;1922 AK;1922 K	AVX 13 x 1525 TM
				ALT	UNTIL MTR-NO: 632564; MTR-CODE: OM 441.905; MOD: 1922;1922 AK;1922 K	AVX 13 x 1550 TM
				FAN	FROM MTR-NO: 712354; MTR-CODE: OM 441.905; MOD: 1922;1922 AK;1922 K	AVX 13 x 1550 TM

#### 1929

15080 ccm	210-218 kW	OM 442.906;OM 442.907;OM 442.908;OM 442.916;OM 442.923;OM 442.925 OM 442.906;OM 442.907;OM 442.909;OM 442.924	07.87 - 09.96	AIR-C	MTR-CODE: OM 442.906; MOD: 1929 A;1929 AK	AVX 13 x 1350 TM
				ALT	FROM MTR-NO: 632565; UNTIL MTR-NO: 712353; MTR-CODE: OM 442.906; MOD: 1929 A;1929 AK	AVX 13 x 1525 TM
				ALT	FROM MTR-NO: 712354; MTR-CODE: OM 442.906; MOD: 1929 A;1929 AK	AVX 13 x 1575 TM
				ALT	UNTIL MTR-NO: 632564; MTR-CODE: OM 442.906; MOD: 1929 A;1929 AK	AVX 13 x 1575 TM
				HYD-P	MTR-CODE: OM 442.906; MOD: 1929 A;1929 AK; REQ: 3	AVX 13 x 1375 TM
				AIR-C	MTR-CODE: OM 442.906; MOD: 1929 A;1929 AK	AVX 13 x 1350 TM
				ALT	FROM MTR-NO: 632565; UNTIL MTR-NO: 712353; MTR-CODE: OM 442.906; MOD: 1929 A;1929 AK	AVX 13 x 1525 TM
				ALT	FROM MTR-NO: 712354; MTR-CODE: OM 442.906; MOD: 1929 A;1929 AK	AVX 13 x 1575 TM
				ALT	UNTIL MTR-NO: 632564; MTR-CODE: OM 442.906; MOD: 1929 A;1929 AK	AVX 13 x 1575 TM
				HYD-P	MTR-CODE: OM 442.906; MOD: 1929 A;1929 AK; REQ: 3	AVX 13 x 1375 TM
				AIR-C	MTR-CODE: OM 442.906; MOD: 1929 A;1929 AK	AVX 13 x 1350 TM
				ALT	FROM MTR-NO: 632565; UNTIL MTR-NO: 712353; MTR-CODE: OM 442.906; MOD: 1929 A;1929 AK	AVX 13 x 1525 TM
				ALT	FROM MTR-NO: 712354; MTR-CODE: OM 442.906; MOD: 1929 A;1929 AK	AVX 13 x 1575 TM
				ALT	UNTIL MTR-NO: 632564; MTR-CODE: OM 442.906; MOD: 1929 A;1929 AK	AVX 13 x 1575 TM

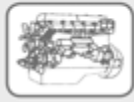

## MERCEDES-BENZ

SK						
<b>1929</b>						
15080 ccm	213-218 kW	OM 442.906;OM 442.907;OM 442.926;OM 442.929	07.87 - 09.96	ALT	UNTIL MTR-NO: 632564; MTR-CODE: OM 442.906; MOD: 1929 A;1929 AK	AVX 13 x 1575 TM
	269 kW			HYD-P	MTR-CODE: OM 442.906; MOD: 1929 A;1929 AK; REQ: 3	AVX 13 x 1375 TM
				AIR-C	MOD: 1929 A	AVX 13 x 1350 TM
				ALT	FROM MTR-NO: 632565; UNTIL MTR-NO: 712353; MOD: 1929 A	AVX 13 x 1525 TM
				ALT	FROM MTR-NO: 712354; MTR-CODE: OM 442.971; MOD: 1929 A	AVX 13 x 1575 TM
				ALT	UNTIL MTR-NO: 632564; MTR-CODE: OM 442.971; MOD: 1929 A	AVX 13 x 1575 TM
				HYD-P	MOD: 1929 A; REQ: 3	AVX 13 x 1375 TM
<b>1948</b>						
14618 ccm	353-362 kW	OM 442.982;OM 442.984;OM 442.985;OM 442.989	09.88 - 07.92	AIR-C	MTR-CODE: OM 442.982	AVX 13 x 1350 TM
				ALT	FROM MTR-NO: 632565; UNTIL MTR-NO: 712353; MTR-CODE: OM 442.982	AVX 13 x 1525 TM
				ALT	FROM MTR-NO: 712354; MTR-CODE: OM 442.982	AVX 13 x 1575 TM
				ALT	UNTIL MTR-NO: 632564; MTR-CODE: OM 442.982	AVX 13 x 1575 TM
				HYD-P	MTR-CODE: OM 442.982; REQ: 3	AVX 13 x 1375 TM
<b>2024</b>						
9600 ccm	180 kW	OM 401.975	02.93 - 09.96	ALT	FROM MTR-NO: 632565; UNTIL MTR-NO: 712353; MOD: 2024;2024 AK;2024 K	AVX 13 x 1525 TM
				ALT	FROM MTR-NO: 712354; MTR-CODE: OM 401.975; MOD: 2024;2024 AK;2024 K	AVX 13 x 1575 TM
				ALT	UNTIL MTR-NO: 632564; MTR-CODE: OM 401.975; MOD: 2024;2024 AK;2024 K	AVX 13 x 1575 TM
		OM 401.984		ALT	FROM MTR-NO: 632565; UNTIL MTR-NO: 712353; MTR-CODE: OM 401.975; MOD: 2024;2024 AK;2024 K	AVX 13 x 1525 TM
				ALT	FROM MTR-NO: 712354; MTR-CODE: OM 401.975; MOD: 2024;2024 AK;2024 K	AVX 13 x 1575 TM
				ALT	UNTIL MTR-NO: 632564; MTR-CODE: OM 401.975; MOD: 2024;2024 AK;2024 K	AVX 13 x 1575 TM
<b>2031</b>						
9572 ccm	230 kW	OM 401.972;OM 401.979;OM 401.993	03.92 - 09.96	ALT	FROM MTR-NO: 632565; UNTIL MTR-NO: 712353; MTR-CODE: OM 401.972; MOD: 2031;2031 A;2031 AS	AVX 13 x 1525 TM
				ALT	FROM MTR-NO: 712354; MTR-CODE: OM 401.972; MOD: 2031;2031 A;2031 AS	AVX 13 x 1575 TM
				ALT	UNTIL MTR-NO: 632564; MTR-CODE: OM 401.972; MOD: 2031;2031 A;2031 AS	AVX 13 x 1575 TM
		OM 401.986		ALT	FROM MTR-NO: 632565; UNTIL MTR-NO: 712353; MTR-CODE: OM 401.972; MOD: 2031;2031 A;2031 AS	AVX 13 x 1525 TM
				ALT	FROM MTR-NO: 712354; MTR-CODE: OM 401.972; MOD: 2031;2031 A;2031 AS	AVX 13 x 1575 TM
				ALT	UNTIL MTR-NO: 632564; MTR-CODE: OM 401.972; MOD: 2031;2031 A;2031 AS	AVX 13 x 1575 TM
<b>2038</b>						
12763 ccm	280 kW	OM 402.971;OM 402.972;OM 402.985;OM 402.986;OM 402.996	11.91 -	ALT	FROM MTR-NO: 632565; UNTIL MTR-NO: 712353; MTR-CODE: OM 402.971; MOD: 2038;2038 AS;2038 S	AVX 13 x 1525 TM
				ALT	FROM MTR-NO: 712354; MTR-CODE: OM 402.971; MOD: 2038;2038 AS;2038 S	AVX 13 x 1575 TM
				ALT	UNTIL MTR-NO: 632564; MTR-CODE: OM 402.971; MOD: 2038;2038 AS;2038 S	AVX 13 x 1575 TM
		OM 402.971;OM 402.985		ALT	FROM MTR-NO: 632565; UNTIL MTR-NO: 712353; MTR-CODE: OM 402.971; MOD: 2038;2038 AS;2038 S	AVX 13 x 1525 TM
				ALT	FROM MTR-NO: 712354; MTR-CODE: OM 402.971; MOD: 2038;2038 AS;2038 S	AVX 13 x 1575 TM
				ALT	UNTIL MTR-NO: 632564; MTR-CODE: OM 402.971; MOD: 2038;2038 AS;2038 S	AVX 13 x 1575 TM
		OM 402.978		ALT	FROM MTR-NO: 632565; UNTIL MTR-NO: 712353; MTR-CODE: OM 402.971; MOD: 2038;2038 AS;2038 S	AVX 13 x 1525 TM
				ALT	FROM MTR-NO: 712354; MTR-CODE: OM 402.971; MOD: 2038;2038 AS;2038 S	AVX 13 x 1575 TM
				ALT	UNTIL MTR-NO: 632564; MTR-CODE: OM 402.971; MOD: 2038;2038 AS;2038 S	AVX 13 x 1575 TM



## MERCEDES-BENZ

### SK

#### 2038

14618 ccm	280 kW	OM 446.927	11.91 -	ALT	FROM MTR-NO: 712354; MOD: 2038 AS	AVX 13 x 1575 TM
				ALT	UNTIL MTR-NO: 712353; MOD: 2038 AS	AVX 13 x 1525 TM
	320 kW	OM 440.970;OM 440.979		ALT	MTR-CODE: OM 440.970; MOD: 2038 AS	AVX 13 x 1575 TM

#### 2044

14618 ccm	320 kW	OM 440.970;OM 440.978;OM 446.922	01.92 - 09.96	ALT	FROM MTR-NO: 712354; MTR-CODE: OM 440.970; MOD: 2044;2044 S	AVX 13 x 1575 TM
				ALT	MTR-CODE: OM 440.970;OM 446.922; MOD: 2044;2044 S	AVX 13 x 1575 TM
				ALT	UNTIL MTR-NO: 712353; MTR-CODE: OM 440.970; MOD: 2044;2044 S	AVX 13 x 1525 TM
		OM 440.970;OM 446.922		ALT	FROM MTR-NO: 712354; MTR-CODE: OM 440.970; MOD: 2044;2044 S	AVX 13 x 1575 TM
				ALT	MTR-CODE: OM 440.970;OM 446.922; MOD: 2044;2044 S	AVX 13 x 1575 TM
				ALT	UNTIL MTR-NO: 712353; MTR-CODE: OM 440.970; MOD: 2044;2044 S	AVX 13 x 1525 TM

#### 2050

14618 ccm	362-390 kW	OM 440.976;OM 442.985;OM 442.989;OM 442.992;OM 442.997;OM 446.920	01.91 - 09.96	ALT	FROM MTR-NO: 632565; UNTIL MTR-NO: 712353; MTR-CODE: OM 440.976; MOD: 2050;2050 S; - MTR-CODE: OM 446.920	AVX 13 x 1525 TM
				ALT	FROM MTR-NO: 712354; MTR-CODE: OM 440.976; MOD: 2050;2050 S; - MTR-CODE: OM 446.920	AVX 13 x 1575 TM
				ALT	MTR-CODE: OM 440.976;OM 446.920; MOD: 2050;2050 S	AVX 13 x 1575 TM
				ALT	UNTIL MTR-NO: 632564; MTR-CODE: OM 440.976; MOD: 2050;2050 S; - MTR-CODE: OM 446.920	AVX 13 x 1575 TM
		OM 442.985;OM 442.989;OM 442.992;OM 442.997;OM 446.920		ALT	FROM MTR-NO: 632565; UNTIL MTR-NO: 712353; MTR-CODE: OM 440.976; MOD: 2050;2050 S; - MTR-CODE: OM 446.920	AVX 13 x 1525 TM
				ALT	FROM MTR-NO: 712354; MTR-CODE: OM 440.976; MOD: 2050;2050 S; - MTR-CODE: OM 446.920	AVX 13 x 1575 TM
				ALT	MTR-CODE: OM 440.976;OM 446.920; MOD: 2050;2050 S	AVX 13 x 1575 TM
				ALT	UNTIL MTR-NO: 632564; MTR-CODE: OM 440.976; MOD: 2050;2050 S; - MTR-CODE: OM 446.920	AVX 13 x 1575 TM

#### 2429

15080 ccm	210-218 kW	OM 442.906;OM 442.907;OM 442.923;OM 442.925	07.87 - 09.96	AIR-C	MTR-CODE: OM 442.906; MOD: 2429;2429 K;2429 S	AVX 13 x 1350 TM
				ALT	FROM MTR-NO: 632565; UNTIL MTR-NO: 712353; MTR-CODE: OM 442.906; MOD: 2429;2429 K;2429 S	AVX 13 x 1525 TM
				ALT	FROM MTR-NO: 712354; MTR-CODE: OM 442.906; MOD: 2429;2429 K;2429 S	AVX 13 x 1575 TM
				ALT	UNTIL MTR-NO: 632564; MTR-CODE: OM 442.906; MOD: 2429;2429 K;2429 S	AVX 13 x 1575 TM
				HYD-P	MTR-CODE: OM 442.906; MOD: 2429;2429 K;2429 S; REQ: 3	AVX 13 x 1375 TM
	213-218 kW	OM 442.906;OM 442.907;OM 442.925		AIR-C	MTR-CODE: OM 442.906; MOD: 2429;2429 K;2429 S	AVX 13 x 1350 TM
				ALT	FROM MTR-NO: 632565; UNTIL MTR-NO: 712353; MTR-CODE: OM 442.906; MOD: 2429;2429 K;2429 S	AVX 13 x 1525 TM
				ALT	FROM MTR-NO: 712354; MTR-CODE: OM 442.906; MOD: 2429;2429 K;2429 S	AVX 13 x 1575 TM
				ALT	UNTIL MTR-NO: 632564; MTR-CODE: OM 442.906; MOD: 2429;2429 K;2429 S	AVX 13 x 1575 TM
				HYD-P	MTR-CODE: OM 442.906; MOD: 2429;2429 K;2429 S; REQ: 3	AVX 13 x 1375 TM

#### 2448

14618 ccm	353-362 kW	OM 442.984;OM 442.985;OM 442.989	07.87 - 09.96	AIR-C	MTR-CODE: OM 442.984; MOD: 2448 LS;2448 S	AVX 13 x 1350 TM
				ALT	FROM MTR-NO: 632565; UNTIL MTR-NO: 712353; MTR-CODE: OM 442.984; MOD: 2448 LS;2448 S	AVX 13 x 1525 TM
				ALT	FROM MTR-NO: 712354; MTR-CODE: OM 442.984; MOD: 2448 LS;2448 S	AVX 13 x 1575 TM
				ALT	UNTIL MTR-NO: 632564; MTR-CODE: OM 442.984; MOD: 2448 LS;2448 S	AVX 13 x 1575 TM
				HYD-P	MTR-CODE: OM 442.984; MOD: 2448 LS;2448 S; REQ: 3	AVX 13 x 1375 TM



## MERCEDES-BENZ

SK						
<b>2448</b>						
14618 ccm	353-362 kW	OM 442.985;OM 442.989;OM 442.992	07.87 - 09.96	AIR-C	MTR-CODE: OM 442.984; MOD: 2448 LS;2448 S	AVX 13 x 1350 TM
				ALT	FROM MTR-NO: 632565; UNTIL MTR-NO: 712353; MTR-CODE: OM 442.984; MOD: 2448 LS;2448 S	AVX 13 x 1525 TM
				ALT	FROM MTR-NO: 712354; MTR-CODE: OM 442.984; MOD: 2448 LS;2448 S	AVX 13 x 1575 TM
				ALT	UNTIL MTR-NO: 632564; MTR-CODE: OM 442.984; MOD: 2448 LS;2448 S	AVX 13 x 1575 TM
				HYD-P	MTR-CODE: OM 442.984; MOD: 2448 LS;2448 S; REQ: 3	AVX 13 x 1375 TM
<b>2538</b>						
12763 ccm	280 kW	OM 402.971;OM 402.972;OM 402.975;OM 402.985;OM 402.986;OM 402.989	07.87 - 09.96	ALT	FROM MTR-NO: 632565; UNTIL MTR-NO: 712353; MTR-CODE: OM 402.971; MOD: 2538	AVX 13 x 1525 TM
				ALT	FROM MTR-NO: 712354; MTR-CODE: OM 402.971; MOD: 2538	AVX 13 x 1575 TM
				ALT	UNTIL MTR-NO: 632564; MTR-CODE: OM 402.971; MOD: 2538	AVX 13 x 1575 TM
		OM 402.971;OM 402.972;OM 402.975;OM 402.985;OM 402.986;OM 402.989;OM 402.990		ALT	FROM MTR-NO: 632565; UNTIL MTR-NO: 712353; MTR-CODE: OM 402.971; MOD: 2538	AVX 13 x 1525 TM
				ALT	FROM MTR-NO: 712354; MTR-CODE: OM 402.971; MOD: 2538	AVX 13 x 1575 TM
				ALT	UNTIL MTR-NO: 632564; MTR-CODE: OM 402.971; MOD: 2538	AVX 13 x 1575 TM
14618 ccm		OM 446.924;OM 446.925		ALT	MTR-CODE: OM 446.924; MOD: 2538	AVX 13 x 1575 TM
		OM 446.924;OM 446.925;OM 446.928;OM 446.929		ALT	MTR-CODE: OM 446.924; MOD: 2538	AVX 13 x 1575 TM
	320 kW	OM 440.970;OM 440.978;OM 440.980		ALT	FROM MTR-NO: 712354; MTR-CODE: OM 440;OM 440.970; MOD: 2538 K; 2538 LK	AVX 13 x 1575 TM
				ALT	MTR-CODE: OM 440.970;OM 446; MOD: 2538 K; 2538 LK	AVX 13 x 1575 TM
				ALT	UNTIL MTR-NO: 712353; MTR-CODE: OM 440;OM 440.970; MOD: 2538 K; 2538 LK	AVX 13 x 1525 TM
		OM 440.970;OM 440.978;OM 440.980;OM 446.942;OM 446.948		ALT	FROM MTR-NO: 712354; MTR-CODE: OM 440;OM 440.970; MOD: 2538 K; 2538 LK	AVX 13 x 1575 TM
				ALT	MTR-CODE: OM 440.970;OM 446; MOD: 2538 K; 2538 LK	AVX 13 x 1575 TM
				ALT	UNTIL MTR-NO: 712353; MTR-CODE: OM 440;OM 440.970; MOD: 2538 K; 2538 LK	AVX 13 x 1525 TM
	362-370 kW	OM 440.971;OM 440.981;OM 442.989;OM 442.997		ALT	FROM MTR-NO: 712354; MTR-CODE: OM 440.971; MOD: 2538 K; 2538 LK	AVX 13 x 1575 TM
				ALT	UNTIL MTR-NO: 712353; MTR-CODE: OM 440.971; MOD: 2538 K; 2538 LK	AVX 13 x 1525 TM
	370 kW	OM 440.971;OM 440.981		ALT	FROM MTR-NO: 712354; MTR-CODE: OM 440.971; MOD: 2538;2538 S	AVX 13 x 1575 TM
				ALT	UNTIL MTR-NO: 712353; MTR-CODE: OM 440.971; MOD: 2538;2538 S	AVX 13 x 1525 TM
		OM 440.971;OM 440.981;OM 442.997		ALT	FROM MTR-NO: 712354; MTR-CODE: OM 440.971; MOD: 2538;2538 S	AVX 13 x 1575 TM
				ALT	UNTIL MTR-NO: 712353; MTR-CODE: OM 440.971; MOD: 2538;2538 S	AVX 13 x 1525 TM
<b>2544</b>						
14618 ccm	320 kW	OM 440.970;OM 440.972;OM 446.922	07.87 - 09.96	ALT	FROM MTR-NO: 712354; MTR-CODE: OM 440.970; MOD: 2544 S;2544;2544 L; - MTR-CODE: OM 446.922	AVX 13 x 1575 TM
				ALT	MTR-CODE: OM 440.970;OM 446.922; MOD: 2544 S;2544;2544 L	AVX 13 x 1575 TM
				ALT	UNTIL MTR-NO: 712353; MTR-CODE: OM 440.970; MOD: 2544 S;2544;2544 L; - MTR-CODE: OM 446.922	AVX 13 x 1525 TM
		OM 440.970;OM 440.978;OM 446.922		ALT	FROM MTR-NO: 712354; MTR-CODE: OM 440.970; MOD: 2544 S;2544;2544 L; - MTR-CODE: OM 446.922	AVX 13 x 1575 TM
				ALT	MTR-CODE: OM 440.970;OM 446.922; MOD: 2544 S;2544;2544 L	AVX 13 x 1575 TM
				ALT	UNTIL MTR-NO: 712353; MTR-CODE: OM 440.970; MOD: 2544 S;2544;2544 L; - MTR-CODE: OM 446.922	AVX 13 x 1525 TM



## MERCEDES-BENZ

### SK

#### 2550

14618 ccm	370-390 kW	OM 440.971;OM 440.973;OM 442.997;OM 442.998;OM 446.920	07.87 - 09.96	ALT	FROM MTR-NO: 712354; MTR-CODE: OM 440.971; MOD: 2550 S; 2550 LS	<b>AVX 13 x 1575 TM</b>
				ALT	MTR-CODE: OM 440.971; MOD: 2550 S; 2550 LS; - MTR-CODE: OM 446.920	<b>AVX 13 x 1575 TM</b>
				ALT	UNTIL MTR-NO: 632564; MTR-CODE: OM 440.971; MOD: 2550 S; 2550 LS; - MTR-CODE: OM 440	<b>AVX 13 x 1575 TM</b>
				ALT	UNTIL MTR-NO: 712353; MTR-CODE: OM 440.971; MOD: 2550 S; 2550 LS	<b>AVX 13 x 1525 TM</b>

#### 2553

14618 ccm	390 kW	OM 446.920	07.87 - 09.96	AC-C	MTR-CODE: OM 446.920; MOD: 2553 S; 2553 LS	<b>AVX 13 x 1350 TM</b>
				AC-C	MTR-CODE: OM 446; MOD: 3553	<b>AVX 13 x 1350 TM</b>
				AIR-C	FROM: 01.94; MTR-CODE: OM 446; MOD: 3553	<b>AVX 13 x 1350 TM</b>
				ALT	FROM: 01.94; MTR-CODE: OM 446; MOD: 3553	<b>AVX 13 x 1575 TM</b>
				ALT	MTR-CODE: OM 446.920; MOD: 2553 S; 2553 LS	<b>AVX 13 x 1575 TM</b>
				ALT	MTR-CODE: OM 446; MOD: 3553	<b>AVX 13 x 1575 TM</b>

#### 2629

15080 ccm	213-218 kW	OM 442.906;OM 442.907;OM 442.917;OM 442.925;OM 442.926;OM 442.929	07.88 - 08.94	AIR-C	MTR-CODE: OM 442.906; MOD: 2629;2629 A;2629 AK	<b>AVX 13 x 1350 TM</b>
				ALT	FROM MTR-NO: 632565; UNTIL MTR-NO: 712353; MTR-CODE: OM 442.906; MOD: 2629;2629 A;2629 AK	<b>AVX 13 x 1525 TM</b>
				ALT	FROM MTR-NO: 712354; MTR-CODE: OM 442.906; MOD: 2629;2629 A;2629 AK	<b>AVX 13 x 1575 TM</b>
				ALT	UNTIL MTR-NO: 632564; MTR-CODE: OM 442.906; MOD: 2629;2629 A;2629 AK	<b>AVX 13 x 1575 TM</b>
				HYD-P	MTR-CODE: OM 442.906; MOD: 2629;2629 A;2629 AK; REQ: 3	<b>AVX 13 x 1375 TM</b>
		OM 442.907;OM 442.926		AIR-C	MTR-CODE: OM 442.906; MOD: 2629;2629 A;2629 AK	<b>AVX 13 x 1350 TM</b>
				ALT	FROM MTR-NO: 632565; UNTIL MTR-NO: 712353; MTR-CODE: OM 442.906; MOD: 2629;2629 A;2629 AK	<b>AVX 13 x 1525 TM</b>
				ALT	FROM MTR-NO: 712354; MTR-CODE: OM 442.906; MOD: 2629;2629 A;2629 AK	<b>AVX 13 x 1575 TM</b>
				ALT	UNTIL MTR-NO: 632564; MTR-CODE: OM 442.906; MOD: 2629;2629 A;2629 AK	<b>AVX 13 x 1575 TM</b>
				HYD-P	MTR-CODE: OM 442.906; MOD: 2629;2629 A;2629 AK; REQ: 3	<b>AVX 13 x 1375 TM</b>

#### 2631

9572 ccm	230 kW	OM 401.972;OM 401.979;OM 401.981;OM 401.987;OM 401.993	07.88 - 09.96	ALT	FROM MTR-NO: 632565; UNTIL MTR-NO: 712353; MTR-CODE: OM 401.972; MOD: 2631;2631 A;2631 AK	<b>AVX 13 x 1525 TM</b>
				ALT	FROM MTR-NO: 712354; MTR-CODE: OM 401.972; MOD: 2631;2631 A;2631 AK	<b>AVX 13 x 1575 TM</b>
				ALT	UNTIL MTR-NO: 632564; MTR-CODE: OM 401.972; MOD: 2631;2631 A;2631 AK	<b>AVX 13 x 1575 TM</b>
		OM 401.986		ALT	FROM MTR-NO: 632565; UNTIL MTR-NO: 712353; MTR-CODE: OM 401.972; MOD: 2631;2631 A;2631 AK	<b>AVX 13 x 1525 TM</b>
				ALT	FROM MTR-NO: 712354; MTR-CODE: OM 401.972; MOD: 2631;2631 A;2631 AK	<b>AVX 13 x 1575 TM</b>
				ALT	UNTIL MTR-NO: 632564; MTR-CODE: OM 401.972; MOD: 2631;2631 A;2631 AK	<b>AVX 13 x 1575 TM</b>
10964 ccm	230-250 kW	OM 441.998;OM 445.920;OM 445.929;OM 445.930;OM 445.931		ALT	FROM MTR-NO: 632565; UNTIL MTR-NO: 712353; MTR-CODE: OM 441.998; MOD: 2631;2631 A;2631 AK	<b>AVX 13 x 1525 TM</b>
				ALT	FROM MTR-NO: 712354; MTR-CODE: OM 441.998; MOD: 2631;2631 A;2631 AK	<b>AVX 13 x 1575 TM</b>
				ALT	UNTIL MTR-NO: 632564; MTR-CODE: OM 441.998; MOD: 2631;2631 A;2631 AK	<b>AVX 13 x 1575 TM</b>
	230 kW	OM 441.998;OM 445.929;OM 445.930;OM 445.931		ALT	FROM MTR-NO: 632565; UNTIL MTR-NO: 712353; MTR-CODE: OM 441.998; MOD: 2631;2631 A;2631 AK	<b>AVX 13 x 1525 TM</b>
				ALT	FROM MTR-NO: 712354; MTR-CODE: OM 441.998; MOD: 2631;2631 A;2631 AK	<b>AVX 13 x 1575 TM</b>
				ALT	UNTIL MTR-NO: 632564; MTR-CODE: OM 441.998; MOD: 2631;2631 A;2631 AK	<b>AVX 13 x 1575 TM</b>

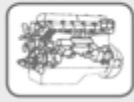

## MERCEDES-BENZ

SK						
<b>2631</b>						
10964 ccm	230 kW	OM 445.930	07.88 - 09.96	ALT	FROM MTR-NO: 632565; UNTIL MTR-NO: 712353; MTR-CODE: OM 441.998; MOD: 2631;2631 A;2631 AK	AVX 13 x 1525 TM
				ALT	FROM MTR-NO: 712354; MTR-CODE: OM 441.998; MOD: 2631;2631 A;2631 AK	AVX 13 x 1575 TM
				ALT	UNTIL MTR-NO: 632564; MTR-CODE: OM 441.998; MOD: 2631;2631 A;2631 AK	AVX 13 x 1575 TM
<b>2631; 2634</b>						
9572 ccm	230 kW	OM 401.986	06.92 - 09.96	ALT	FROM MTR-NO: 632565; UNTIL MTR-NO: 712353; MTR-CODE: OM 401.972; MOD: 2631;2631 A;2631 AK	AVX 13 x 1525 TM
				ALT	FROM MTR-NO: 712354; MTR-CODE: OM 401.972; MOD: 2631;2631 A;2631 AK	AVX 13 x 1575 TM
				ALT	UNTIL MTR-NO: 632564; MTR-CODE: OM 401.972; MOD: 2631;2631 A;2631 AK	AVX 13 x 1575 TM
10964 ccm		OM 445.930		ALT	FROM MTR-NO: 632565; UNTIL MTR-NO: 712353; MTR-CODE: OM 441.998; MOD: 2631;2631 A;2631 AK	AVX 13 x 1525 TM
				ALT	FROM MTR-NO: 712354; MTR-CODE: OM 441.998; MOD: 2631;2631 A;2631 AK	AVX 13 x 1575 TM
				ALT	UNTIL MTR-NO: 632564; MTR-CODE: OM 441.998; MOD: 2631;2631 A;2631 AK	AVX 13 x 1575 TM
<b>2638</b>						
12763 ccm	280 kW	OM 402.971;OM 402.972;OM 402.975;OM 402.985;OM 402.986	09.91 - 09.96	ALT	FROM MTR-NO: 632565; UNTIL MTR-NO: 712353; MTR-CODE: OM 402.971; MOD: 2638 AK;2638 AS	AVX 13 x 1525 TM
				ALT	FROM MTR-NO: 712354; MTR-CODE: OM 402.971; MOD: 2638 AK;2638 AS	AVX 13 x 1575 TM
				ALT	UNTIL MTR-NO: 632564; MTR-CODE: OM 402.971; MOD: 2638 AK;2638 AS	AVX 13 x 1575 TM
		OM 402.975;OM 402.978;OM 402.996		ALT	FROM MTR-NO: 632565; UNTIL MTR-NO: 712353; MTR-CODE: OM 402.971; MOD: 2638 AK;2638 AS	AVX 13 x 1525 TM
				ALT	FROM MTR-NO: 712354; MTR-CODE: OM 402.971; MOD: 2638 AK;2638 AS	AVX 13 x 1575 TM
				ALT	UNTIL MTR-NO: 632564; MTR-CODE: OM 402.971; MOD: 2638 AK;2638 AS	AVX 13 x 1575 TM
14618 ccm		OM 440.990;OM 446.924;OM 446.925;OM 446.926		ALT	FROM MTR-NO: 712354; MTR-CODE: OM 440;OM 440.990; MOD: 2638 AK;2638 AS	AVX 13 x 1575 TM
				ALT	MTR-CODE: OM 440.990;OM 446; MOD: 2638 AK;2638 AS	AVX 13 x 1575 TM
				ALT	UNTIL MTR-NO: 712353; MTR-CODE: OM 440;OM 440.990; MOD: 2638 AK;2638 AS	AVX 13 x 1525 TM
		OM 446.927		ALT	FROM MTR-NO: 712354; MTR-CODE: OM 440;OM 440.990; MOD: 2638 AK;2638 AS	AVX 13 x 1575 TM
				ALT	MTR-CODE: OM 440.990;OM 446; MOD: 2638 AK;2638 AS	AVX 13 x 1575 TM
				ALT	UNTIL MTR-NO: 712353; MTR-CODE: OM 440;OM 440.990; MOD: 2638 AK;2638 AS	AVX 13 x 1525 TM
320 kW		OM 440.970;OM 440.978		ALT	FROM MTR-NO: 712354; MTR-CODE: OM 440;OM 440.970; MOD: 2638 AK;2638 AS	AVX 13 x 1575 TM
				ALT	MTR-CODE: OM 440.970;OM 446; MOD: 2638 AK;2638 AS	AVX 13 x 1575 TM
				ALT	UNTIL MTR-NO: 712353; MTR-CODE: OM 440;OM 440.970; MOD: 2638 AK;2638 AS	AVX 13 x 1525 TM
		OM 440.970;OM 440.979;OM 446.936		ALT	FROM MTR-NO: 712354; MTR-CODE: OM 440;OM 440.970; MOD: 2638 AK;2638 AS	AVX 13 x 1575 TM
				ALT	MTR-CODE: OM 440.970;OM 446; MOD: 2638 AK;2638 AS	AVX 13 x 1575 TM
				ALT	UNTIL MTR-NO: 712353; MTR-CODE: OM 440;OM 440.970; MOD: 2638 AK;2638 AS	AVX 13 x 1525 TM
362 kW		OM 442.989		ALT	FROM MTR-NO: 712354; MOD: 2638 K	AVX 13 x 1575 TM
				ALT	UNTIL MTR-NO: 712353; MOD: 2638 K	AVX 13 x 1525 TM
370 kW		OM 440.981		ALT	FROM MTR-NO: 712354; MOD: 2638 AK;2638 AS	AVX 13 x 1575 TM
				ALT	UNTIL MTR-NO: 712353; MOD: 2638 AK;2638 AS	AVX 13 x 1525 TM
		OM 440.981;OM 442.997		ALT	FROM MTR-NO: 712354; MTR-CODE: OM 440.981; MOD: 2638 AK;2638 AS	AVX 13 x 1575 TM
				ALT	UNTIL MTR-NO: 712353; MTR-CODE: OM 440.981; MOD: 2638 AK;2638 AS	AVX 13 x 1525 TM
		OM 440.982		ALT	FROM MTR-NO: 712354; MTR-CODE: OM 440.981; MOD: 2638 AK;2638 AS	AVX 13 x 1575 TM

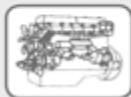

## MERCEDES-BENZ

### SK

#### 2638

14618 ccm	370 kW	OM 440.982	09.91 - 09.96	ALT	UNTIL MTR-NO: 712353; MTR-CODE: OM 440.981; MOD: 2638 AK;2638 AS	AVX 13 x 1525 TM
		OM 442.997		ALT	FROM MTR-NO: 712354; MTR-CODE: OM 440.981; MOD: 2638 AK;2638 AS	AVX 13 x 1575 TM
				ALT	UNTIL MTR-NO: 712353; MTR-CODE: OM 440.981; MOD: 2638 AK;2638 AS	AVX 13 x 1525 TM

#### 2644

14618 ccm	320 kW	OM 440.970;OM 440.978;OM 446.922	01.92 - 09.96	ALT	FROM MTR-NO: 712354; MTR-CODE: OM 440.970; MOD: 2644 S;2644; 2644 L; - MTR-CODE: OM 446.922	AVX 13 x 1575 TM
				ALT	MTR-CODE: OM 440.970;OM 446.922; MOD: 2644 S;2644; 2644 L	AVX 13 x 1575 TM
				ALT	UNTIL MTR-NO: 712353; MTR-CODE: OM 440.970; MOD: 2644 S;2644; 2644 L; - MTR-CODE: OM 446.922	AVX 13 x 1525 TM
		OM 440.970;OM 446.922		ALT	FROM MTR-NO: 712354; MTR-CODE: OM 440.970; MOD: 2644 S;2644; 2644 L; - MTR-CODE: OM 446.922	AVX 13 x 1575 TM
				ALT	MTR-CODE: OM 440.970;OM 446.922; MOD: 2644 S;2644; 2644 L	AVX 13 x 1575 TM
				ALT	UNTIL MTR-NO: 712353; MTR-CODE: OM 440.970; MOD: 2644 S;2644; 2644 L; - MTR-CODE: OM 446.922	AVX 13 x 1525 TM

#### 2648

14618 ccm	329 kW	OM 442.983	07.88 - 08.94	AIR-C	MOD: 2648 S	AVX 13 x 1350 TM
				ALT	FROM MTR-NO: 632565; UNTIL MTR-NO: 712353; MOD: 2648 S	AVX 13 x 1525 TM
				ALT	FROM MTR-NO: 712354; MTR-CODE: OM 442.983; MOD: 2648 S	AVX 13 x 1575 TM
				ALT	UNTIL MTR-NO: 632564; MTR-CODE: OM 442.983; MOD: 2648 S	AVX 13 x 1575 TM
				HYD-P	MOD: 2648 S; REQ: 3	AVX 13 x 1375 TM
				AIR-C	MTR-CODE: OM 442.985; MOD: 2648 S	AVX 13 x 1350 TM
				ALT	FROM MTR-NO: 632565; UNTIL MTR-NO: 712353; MTR-CODE: OM 442.985; MOD: 2648 S	AVX 13 x 1525 TM
				ALT	FROM MTR-NO: 712354; MTR-CODE: OM 442.985; MOD: 2648 S	AVX 13 x 1575 TM
				ALT	UNTIL MTR-NO: 632564; MTR-CODE: OM 442.985; MOD: 2648 S	AVX 13 x 1575 TM
				HYD-P	MTR-CODE: OM 442.985; MOD: 2648 S; REQ: 3	AVX 13 x 1375 TM

#### 2650

14618 ccm	362-370 kW	OM 440.973;OM 440.981;OM 442.989;OM 442.997	07.87 - 09.96	ALT	FROM MTR-NO: 712354; MTR-CODE: OM 440.971; MOD: 2650 S;2650; 2650 L	AVX 13 x 1575 TM
				ALT	UNTIL MTR-NO: 712353; MTR-CODE: OM 440.971; MOD: 2650 S;2650; 2650 L	AVX 13 x 1525 TM
				ALT	FROM MTR-NO: 712354; MTR-CODE: OM 440.971; MOD: 2650 S;2650; 2650 L	AVX 13 x 1575 TM
				ALT	UNTIL MTR-NO: 712353; MTR-CODE: OM 440.971; MOD: 2650 S;2650; 2650 L	AVX 13 x 1525 TM

#### 2653

14618 ccm	390 kW	OM 446.920	07.92 - 09.96	ALT	MOD: 2650	AVX 13 x 1575 TM
-----------	--------	------------	---------------	-----	-----------	------------------

#### 3229

15078 ccm	210-218 kW	OM 442.915;OM 442.916;OM 442.923;OM 442.927;OM 442.928	09.89 - 08.94	AIR-C	MTR-CODE: OM 442.915; MOD: 3229;3229 B;3229 K	AVX 13 x 1350 TM
				ALT	FROM MTR-NO: 632565; UNTIL MTR-NO: 712353; MTR-CODE: OM 442.915; MOD: 3229;3229 B;3229 K	AVX 13 x 1525 TM
				ALT	FROM MTR-NO: 712354; MTR-CODE: OM 442.915; MOD: 3229;3229 B;3229 K	AVX 13 x 1575 TM
				ALT	UNTIL MTR-NO: 632564; MTR-CODE: OM 442.915; MOD: 3229;3229 B;3229 K	AVX 13 x 1575 TM
				HYD-P	MTR-CODE: OM 442.915; MOD: 3229;3229 B;3229 K; REQ: 3	AVX 13 x 1375 TM
				AIR-C	MTR-CODE: OM 442.915; MOD: 3229;3229 B;3229 K	AVX 13 x 1350 TM
				ALT	FROM MTR-NO: 632565; UNTIL MTR-NO: 712353; MTR-CODE: OM 442.915; MOD: 3229;3229 B;3229 K	AVX 13 x 1525 TM
				ALT	FROM MTR-NO: 712354; MTR-CODE: OM 442.915; MOD: 3229;3229 B;3229 K	AVX 13 x 1575 TM



## MERCEDES-BENZ

SK						
<b>3229</b>						
15078 ccm	213-218 kW	OM 442.915;OM 442.916;OM 442.927;OM 442.928	09.89 - 08.94	ALT	UNTIL MTR-NO: 632564; MTR-CODE: OM 442.915; MOD: 3229;3229 B;3229 K	AVX 13 x 1575 TM
				HYD-P	MTR-CODE: OM 442.915; MOD: 3229;3229 B;3229 K; REQ: 3	AVX 13 x 1375 TM
<b>3233</b>						
10964 ccm	250 kW	OM 441.982	10.90 - 07.92	AIR-C	MOD: 3233 B;3233 K	AVX 13 x 1350 TM
				ALT	FROM MTR-NO: 632565; UNTIL MTR-NO: 712353; MOD: 3233 B;3233 K	AVX 13 x 1525 TM
				ALT	FROM MTR-NO: 712354; MTR-CODE: OM 441.982; MOD: 3233 B;3233 K	AVX 13 x 1575 TM
				ALT	UNTIL MTR-NO: 632564; MTR-CODE: OM 441.982; MOD: 3233 B;3233 K	AVX 13 x 1575 TM
				HYD-P	MOD: 3233 B;3233 K; REQ: 3	AVX 13 x 1375 TM
		OM 441.982;OM 441.985		AIR-C	MTR-CODE: OM 441.982; MOD: 3233 B;3233 K	AVX 13 x 1350 TM
				ALT	FROM MTR-NO: 632565; UNTIL MTR-NO: 712353; MTR-CODE: OM 441.982; MOD: 3233 B;3233 K	AVX 13 x 1525 TM
				ALT	FROM MTR-NO: 712354; MTR-CODE: OM 441.982; MOD: 3233 B;3233 K	AVX 13 x 1575 TM
				ALT	UNTIL MTR-NO: 632564; MTR-CODE: OM 441.982; MOD: 3233 B;3233 K	AVX 13 x 1575 TM
				HYD-P	MTR-CODE: OM 441.982; MOD: 3233 B;3233 K; REQ: 3	AVX 13 x 1375 TM
<b>3234</b>						
10964 ccm	250 kW	OM 441.988;OM 441.990;OM 441.992;OM 445.922	02.92 - 09.96	AIR-C	FROM MTR-NO: 712354; MTR-CODE: OM 441.988; MOD: 3234 B;3234 K; - MTR-CODE: OM 445	AVX 13 x 1350 TM
				ALT	FROM MTR-NO: 632565; UNTIL MTR-NO: 712353; MTR-CODE: OM 441.988; MOD: 3234 B;3234 K; - MTR-CODE: OM 445	AVX 13 x 1525 TM
				ALT	UNTIL MTR-NO: 632564; MTR-CODE: OM 441.988; MOD: 3234 B;3234 K; - MTR-CODE: OM 445	AVX 13 x 1550 TM
<b>3238</b>						
12763 ccm	280 kW	OM 402.971;OM 402.973;OM 402.977;OM 402.982;OM 402.987	07.87 - 09.96	ALT	FROM MTR-NO: 632565; UNTIL MTR-NO: 712353; MTR-CODE: OM 402.971; MOD: 3238	AVX 13 x 1525 TM
				ALT	FROM MTR-NO: 712354; MTR-CODE: OM 402.971; MOD: 3238	AVX 13 x 1575 TM
				ALT	UNTIL MTR-NO: 632564; MTR-CODE: OM 402.971; MOD: 3238	AVX 13 x 1575 TM
14618 ccm		OM 446.926		ALT	MOD: 3238; 3238 L	AVX 13 x 1575 TM
	320 kW	OM 440.970;OM 440.980;OM 446.939		ALT	FROM MTR-NO: 712354; MTR-CODE: OM 440;OM 440.970; MOD: 3238; 3238 L	AVX 13 x 1575 TM
				ALT	MTR-CODE: OM 440.970;OM 446; MOD: 3238; 3238 L	AVX 13 x 1575 TM
				ALT	UNTIL MTR-NO: 712353; MTR-CODE: OM 440;OM 440.970; MOD: 3238; 3238 L	AVX 13 x 1525 TM
	362-370 kW	OM 440.971;OM 442.989;OM 442.997		ALT	FROM MTR-NO: 712354; MTR-CODE: OM 440.971; MOD: 3238	AVX 13 x 1575 TM
				ALT	UNTIL MTR-NO: 712353; MTR-CODE: OM 440.971; MOD: 3238	AVX 13 x 1525 TM
<b>3253</b>						
14618 ccm	390 kW	OM 446.920;OM 446.933;OM 446.945	01.96 - 09.96	AC-C	MTR-CODE: OM 446.920; MOD: 3253; 3253 L	AVX 13 x 1350 TM
				ALT	MTR-CODE: OM 446.920; MOD: 3253; 3253 L	AVX 13 x 1575 TM
<b>3534</b>						
10964 ccm	250 kW	OM 441.988;OM 445.922	10.93 - 09.96	AC-C	FROM MTR-NO: 712354; MTR-CODE: OM 441.988; MOD: 3534 K; - MTR-CODE: OM 445	AVX 13 x 1350 TM
				ALT	FROM MTR-NO: 632565; UNTIL MTR-NO: 712353; MTR-CODE: OM 441.988; MOD: 3534 K; - MTR-CODE: OM 445	AVX 13 x 1525 TM
				ALT	UNTIL MTR-NO: 632564; MTR-CODE: OM 441.988; MOD: 3534 K; - MTR-CODE: OM 445	AVX 13 x 1550 TM
<b>3538</b>						
12763 ccm	280 kW	OM 402.973;OM 402.978;OM 402.982;OM 402.983;OM 402.987	03.91 - 09.96	ALT	FROM MTR-NO: 632565; UNTIL MTR-NO: 712353; MTR-CODE: OM 402.973; MOD: 3538 AK;3538 K	AVX 13 x 1525 TM
				ALT	FROM MTR-NO: 712354; MTR-CODE: OM 402.973; MOD: 3538 AK;3538 K	AVX 13 x 1575 TM
				ALT	UNTIL MTR-NO: 632564; MTR-CODE: OM 402.973; MOD: 3538 AK;3538 K	AVX 13 x 1575 TM



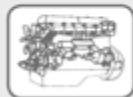

## MERCEDES-BENZ

### SK

#### 3538

14618 ccm	280 kW	OM 446.926;OM 446.930	03.91 - 09.96	ALT	MTR-CODE: OM 446.926; MOD: 3538 AK;3538 K	AVX 13 x 1575 TM
		OM 446.926;OM 446.930;OM 446.931		ALT	MTR-CODE: OM 446.926; MOD: 3538 AK;3538 K	AVX 13 x 1575 TM
	320 kW	OM 440.970;OM 440.979;OM 440.984;OM 440.985;OM 446.939;OM 446.940		ALT	FROM MTR-NO: 712354; MTR-CODE: OM 440;OM 440.970; MOD: 3538 AK;3538 K	AVX 13 x 1575 TM
				ALT	MTR-CODE: OM 440.970;OM 446; MOD: 3538 AK;3538 K	AVX 13 x 1575 TM
				ALT	UNTIL MTR-NO: 712353; MTR-CODE: OM 440;OM 440.970; MOD: 3538 AK;3538 K	AVX 13 x 1525 TM
		OM 440.970;OM 440.979;OM 440.984;OM 446.939;OM 446.940		ALT	FROM MTR-NO: 712354; MTR-CODE: OM 440;OM 440.970; MOD: 3538 AK;3538 K	AVX 13 x 1575 TM
				ALT	MTR-CODE: OM 440.970;OM 446; MOD: 3538 AK;3538 K	AVX 13 x 1575 TM
				ALT	UNTIL MTR-NO: 712353; MTR-CODE: OM 440;OM 440.970; MOD: 3538 AK;3538 K	AVX 13 x 1525 TM
	362-370 kW	OM 440.975;OM 440.982;OM 440.983;OM 442.989		ALT	FROM MTR-NO: 712354; MTR-CODE: OM 440.975; MOD: 3538 K	AVX 13 x 1575 TM
				ALT	UNTIL MTR-NO: 712353; MTR-CODE: OM 440.975; MOD: 3538 K	AVX 13 x 1525 TM
	370 kW	OM 440.975;OM 440.982;OM 440.983;OM 442.997		ALT	FROM MTR-NO: 712354; MTR-CODE: OM 440.975; MOD: 3538 AK	AVX 13 x 1575 TM
				ALT	UNTIL MTR-NO: 712353; MTR-CODE: OM 440.975; MOD: 3538 AK	AVX 13 x 1525 TM

#### 3550; 3553

14618 ccm	362-370 kW	OM 440.975;OM 442.993;OM 442.997	05.92 - 09.96	ALT	FROM MTR-NO: 712354; MTR-CODE: OM 440.975; MOD: 3550 S	AVX 13 x 1575 TM
				ALT	UNTIL MTR-NO: 712353; MTR-CODE: OM 440.975; MOD: 3550 S	AVX 13 x 1525 TM

### TOURISMO (O 350)

#### Tourismo

12763 ccm	280 kW	OM 402.970	08.95 -	ALT	MOD: Torismo	9 PK 4100 TM
14618 ccm		OM 446.938		ALT	MOD: SA510040;Tourismo	9 PK 4145 TM

## MITSUBISHI

### Canter

<b>35</b>						
2835 ccm	69 kW	4M40-A	08.96 -	AC-C	MOD: Canter 35	AVX 13 x 1000 TM
	85 kW	4M40-2AT		AC-C	MOD: Canter 35	AVX 13 x 1000 TM
<b>60</b>						
3908 ccm	100 kW	4D34-2AT4	07.86 -	ALT	MOD: Canter 60; REQ: 2	AVX 13 x 1175 TM
<b>75</b>						
3908 ccm	100 kW	4D34-2AT4	01.94 -	ALT	MOD: Canter 75; REQ: 2	AVX 13 x 1175 TM
4948 ccm	115 kW	6D31-1AT2		ALT	MOD: Canter 75; REQ: 2	AVX 13 x 1200 TM

## MULTICAR

### M26

#### 2; 8

2799 ccm	78 kW	8140.23.2585	01.96 - 12.02	CAM		ZRK 1332
----------	-------	--------------	---------------	-----	--	----------

## NEOPLAN

### Trendliner

#### 3516

11967 ccm	228 kW		09.04 -	2. ALT	MTR-CODE: D 2066 LUH01 <Euro4>; FROM: 01.06; UNTIL: 03.10	8 PK 1158 TM
	265 kW	D 2866 LUH 29		2. ALT	MTR-CODE: D 2066 LUH1 <Euro4>; FROM: 01.06; UNTIL: 03.10	8 PK 1158 TM
	301 kW			2. ALT	MTR-CODE: D 2066 LUH01 <Euro4>; FROM: 01.06; UNTIL: 03.10	8 PK 1158 TM

#### 3516/3

11967 ccm	301 kW		09.04 -	2. ALT	FROM: 01.06; UNTIL: 03.10; MTR-CODE: D 2066 LUH01 <Euro4>	8 PK 1158 TM
-----------	--------	--	---------	--------	---	--------------

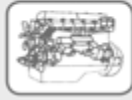

## RENAULT TRUCKS

C							
<b>210.19</b>							
8820 ccm	153 kW	MIDS 06.20.30 N	12.83 - 05.91	ALT	MOD: C 210.19;CLR 220; REQ: 2		AVX 13 x 1650 TM
<b>260.19</b>							
9839 ccm	192 kW	MIDS 06.20.45 B	10.82 - 05.91	ALT	MOD: C 260.19; REQ: 2		AVX 13 x 1650 TM
<b>260.26</b>							
9839 ccm	192 kW	MIDS 06.20.45 B	10.82 - 05.91	ALT	MOD: C 260.26; REQ: 2		AVX 13 x 1650 TM
<b>280.19</b>							
9839 ccm	202 kW	MIDS 06.20.45 B	04.86 - 03.93	ALT	MOD: C 280.19; REQ: 2		AVX 13 x 1650 TM
<b>280.19/T</b>							
12024 ccm	208 kW	MIDS 06.35.40 D	04.86 - 10.92	AC-C	FROM: 06.88; UNTIL: 06.89; MOD: CLM 280.19;T; REQ: 2; + ENG-PTO		AVX 13 x 1550 TM
				AC-C	FROM: 06.88; UNTIL: 06.89; MTR-CODE: MIDS 06.35.40 D; MOD: CLM 280.19;T; REQ: 2; - ENG-PTO		AVX 13 x 1450 TM
				AC-C	UNTIL: 05.88; MTR-CODE: MIDS 06.35.40 D; MOD: CLM 280.19;T; REQ: 2		AVX 13 x 1450 TM
<b>280.26</b>							
12024 ccm	208 kW	MIDS 06.35.40 D	04.86 - 10.92	AC-C	FROM: 06.88; UNTIL: 06.89; MTR-CODE: MIDS 06.35.40 D; MOD: CBH 280.26; REQ: 2; - ENG-PTO		AVX 13 x 1450 TM
				FAN	FROM: 06.88; UNTIL: 06.89; MOD: CBH 280.26; REQ: 2		AVX 13 x 1200 TM
				FAN	FROM: 06.88; UNTIL: 06.89; MOD: CBH 280.26; REQ: 2; + ENG-PTO		AVX 13 x 1550 TM
				FAN	UNTIL: 05.88; MOD: CBH 280.26; REQ: 2		AVX 13 x 1175 TM
				FAN	UNTIL: 05.88; MTR-CODE: MIDS 06.35.40 D; MOD: CBH 280.26; REQ: 2		AVX 13 x 1450 TM
<b>280.26/T</b>							
12024 ccm	208 kW	MIDS 06.35.40 D	04.86 - 10.92	AC-C	FROM: 06.88; UNTIL: 06.89; MTR-CODE: MIDS 06.35.40 D; MOD: CBH 280.26; REQ: 2; - ENG-PTO		AVX 13 x 1450 TM
				FAN	FROM: 06.88; UNTIL: 06.89; MOD: CBH 280.26; REQ: 2; + ENG-PTO		AVX 13 x 1550 TM
				FAN	UNTIL: 05.88; MTR-CODE: MIDS 06.35.40 D; MOD: CBH 280.26; REQ: 2		AVX 13 x 1450 TM
<b>290.19/T</b>							
9839 ccm	214 kW	MIDR 06.20.45 D	05.86 - 05.91	ALT	MOD: C 290.19;T; REQ: 2		AVX 13 x 1650 TM
<b>300.19</b>							
9839 ccm	222 kW	MIDR 06.20.45 D;MIDR 06.20.45 D3	04.87 - 10.98	ALT	UNTIL: 10.93; MTR-CODE: MIDR 06.20.45 D; MOD: C 300.19; REQ: 2; - AMP: 100		AVX 13 x 1650 TM
				ALT	FROM: 10.93; MTR-CODE: MIDR06.20.45D; MOD: C300.19		5 PK 886
<b>300.24</b>							
9839 ccm	222 kW	MIDR 06.20.45 D;MIDR 06.20.45 D3	04.87 - 10.98	ALT	UNTIL: 10.93; MTR-CODE: MIDR 06.20.45 D; MOD: C 300.24;C 300.26; REQ: 2; - AMP: 100		AVX 13 x 1650 TM
				ALT	FROM: 10.93; MTR-CODE: MIDR06.20.45D; MOD: C300.24/C300.26		5 PK 886
<b>300.26</b>							
9839 ccm	222 kW	MIDR 06.20.45 D	04.87 - 10.98	ALT	MOD: CCH 300.26; REQ: 2; - AMP: 100		AVX 13 x 1650 TM
		MIDR 06.20.45 D;MIDR 06.20.45 D3		ALT	UNTIL: 10.93; MTR-CODE: MIDR 06.20.45 D; MOD: C 300.24;C 300.26; REQ: 2; - AMP: 100		AVX 13 x 1650 TM
				ALT	FROM: 10.93; MTR-CODE: MIDR06.20.45D; MOD: C300.24/C300.26		5 PK 886
<b>300.30</b>							
9839 ccm	222 kW	MIDR 06.20.45 D	09.90 - 03.93	ALT	MOD: CCH 300.30; REQ: 2; - AMP: 100		AVX 13 x 1650 TM
<b>320.19/T</b>							
12000 ccm	236 kW	MIDR 06.35.40 M3	10.92 - 10.98	AC-C	MOD: CLM 320.19;T; REQ: 2; - ENG-PTO		AVX 13 x 1125 TM
				FAN	UNTIL: 08.95; MOD: CLM 320.19;T; REQ: 2; - AC; + ENG-PTO		AVX 13 x 1550 TM
				FAN	UNTIL: 08.95; MOD: CLM 320.19;T; REQ: 2; + AC; - ENG-PTO		AVX 13 x 1450 TM
				ALT	FROM: 09.95; MOD: CLM320.19/T		6 PK 1755 TM
				ALT	UNTIL: 08.95; MOD: CLM320.19/T; - AC; - ENG-PTO		5 PK 1540 TM
<b>320.24</b>							
12000 ccm	236 kW	MIDR 06.35.40 M3	10.92 - 10.98	AC-C	MOD: CBH 320.24; REQ: 2; - ENG-PTO		AVX 13 x 1125 TM
				FAN	UNTIL: 08.95; MOD: CBH 320.24; REQ: 2; - AC; + ENG-PTO		AVX 13 x 1550 TM
				FAN	UNTIL: 08.95; MOD: CBH 320.24; REQ: 2; + AC; - ENG-PTO		AVX 13 x 1450 TM
				ALT	FROM: 09.95; MOD: CBH320.24		6 PK 1755 TM



## RENAULT TRUCKS

C						
<b>320.24</b>						
12000 ccm	236 kW	MIDR 06.35.40 M3	10.92 - 10.98	ALT	UNTIL: 08.95; MOD: CBH320.24; - AC; - ENG-PTO	5 PK 1540 TM
<b>320.24/T</b>						
12000 ccm	236 kW	MIDR 06.35.40 M3	10.92 - 10.98	AC-C	MOD: CBH 320.24; REQ: 2; - ENG-PTO	AVX 13 x 1125 TM
				FAN	UNTIL: 08.95; MOD: CBH 320.24; REQ: 2; - AC; + ENG-PTO	AVX 13 x 1550 TM
				FAN	UNTIL: 08.95; MOD: CBH 320.24; REQ: 2; + AC; - ENG-PTO	AVX 13 x 1450 TM
				ALT	FROM: 09.95; MOD: CBH320.24	6 PK 1755 TM
				ALT	UNTIL: 08.95; MOD: CBH320.24; - AC; - ENG-PTO	5 PK 1540 TM
<b>320.25/T</b>						
12000 ccm	236 kW	MIDR 06.35.40 M3	10.92 - 10.98	AC-C	MOD: CLM 320.25;T; REQ: 2; - ENG-PTO	AVX 13 x 1125 TM
				FAN	UNTIL: 08.95; MOD: CLM 320.25;T; REQ: 2; - AC; + ENG-PTO	AVX 13 x 1550 TM
				FAN	UNTIL: 08.95; MOD: CLM 320.25;T; REQ: 2; + AC; - ENG-PTO	AVX 13 x 1450 TM
				ALT	FROM: 09.95; MOD: CLM320.25/T	6 PK 1755 TM
				ALT	UNTIL: 08.95; MOD: CLM320.25/T; - AC; - ENG-PTO	5 PK 1540 TM
<b>320.26</b>						
12000 ccm	236 kW	MIDR 06.35.40 M3	10.92 - 10.98	AC-C	MOD: CBH 320.26; REQ: 2; - ENG-PTO	AVX 13 x 1125 TM
				FAN	UNTIL: 08.95; MOD: CBH 320.26; REQ: 2; - AC; + ENG-PTO	AVX 13 x 1550 TM
				FAN	UNTIL: 08.95; MOD: CBH 320.26; REQ: 2; + AC; - ENG-PTO	AVX 13 x 1175 TM
				FAN	UNTIL: 08.95; MOD: CBH 320.26; REQ: 2; + AC; - ENG-PTO	AVX 13 x 1450 TM
				ALT	FROM: 09.95; MOD: CBH320.26	6 PK 1755 TM
				ALT	UNTIL: 08.95; MOD: CBH320.26; - AC; - ENG-PTO	5 PK 1540 TM
				FAN	FROM: 09.95; MOD: CBH320.26; - ENG-PTO	9 PK 1290 TM
				FAN	UNTIL: 08.95; MOD: CBH320.26; - AC; - ENG-PTO	9 PK 1290 TM
<b>320.26/T</b>						
12000 ccm	236 kW	MIDR 06.35.40 M3	10.92 - 10.98	AC-C	MOD: CBH 320.26; REQ: 2; - ENG-PTO	AVX 13 x 1125 TM
				FAN	UNTIL: 08.95; MOD: CBH 320.26; REQ: 2; - AC; + ENG-PTO	AVX 13 x 1550 TM
				FAN	UNTIL: 08.95; MOD: CBH 320.26; REQ: 2; + AC; - ENG-PTO	AVX 13 x 1175 TM
				FAN	UNTIL: 08.95; MOD: CBH 320.26; REQ: 2; + AC; - ENG-PTO	AVX 13 x 1450 TM
				ALT	FROM: 09.95; MOD: CBH320.26	6 PK 1755 TM
				ALT	UNTIL: 08.95; MOD: CBH320.26; - AC; - ENG-PTO	5 PK 1540 TM
				FAN	FROM: 09.95; MOD: CBH320.26; - ENG-PTO	9 PK 1290 TM
				FAN	UNTIL: 08.95; MOD: CBH320.26; - AC; - ENG-PTO	9 PK 1290 TM
<b>320.34</b>						
12000 ccm	236 kW	MIDR 06.35.40 M3	10.92 - 10.98	AC-C	MOD: CBH 320.34; REQ: 2; - ENG-PTO	AVX 13 x 1125 TM
				FAN	UNTIL: 08.95; MOD: CBH 320.34; REQ: 2; - AC; + ENG-PTO	AVX 13 x 1550 TM
				FAN	UNTIL: 08.95; MOD: CBH 320.34; REQ: 2; + AC; - ENG-PTO	AVX 13 x 1175 TM
				FAN	UNTIL: 08.95; MOD: CBH 320.34; REQ: 2; + AC; - ENG-PTO	AVX 13 x 1450 TM
				ALT	FROM: 09.95; MOD: CBH320.34	6 PK 1755 TM
				ALT	UNTIL: 08.95; MOD: CBH320.34; - AC; - ENG-PTO	5 PK 1540 TM
				FAN	FROM: 09.95; MOD: CBH320.34; - ENG-PTO	9 PK 1290 TM
				FAN	UNTIL: 08.95; MOD: CBH320.34; - AC; - ENG-PTO	9 PK 1290 TM
<b>320.34/T</b>						
12000 ccm	236 kW	MIDR 06.35.40 M3	10.92 - 10.98	AC-C	MOD: CBH 320.34; REQ: 2; - ENG-PTO	AVX 13 x 1125 TM
				FAN	UNTIL: 08.95; MOD: CBH 320.34; REQ: 2; - AC; + ENG-PTO	AVX 13 x 1550 TM
				FAN	UNTIL: 08.95; MOD: CBH 320.34; REQ: 2; + AC; - ENG-PTO	AVX 13 x 1175 TM
				FAN	UNTIL: 08.95; MOD: CBH 320.34; REQ: 2; + AC; - ENG-PTO	AVX 13 x 1450 TM
				ALT	FROM: 09.95; MOD: CBH320.34	6 PK 1755 TM



## RENAULT TRUCKS

C							
<b>320.34/T</b>							
12000 ccm	236 kW	MIDR 06.35.40 M3	10.92 - 10.98	ALT	UNTIL: 08.95; MOD: CBH320.34; - AC; - ENG-PTO		<b>5 PK 1540 TM</b>
				FAN	FROM: 09.95; MOD: CBH320.34; - ENG-PTO		<b>9 PK 1290 TM</b>
				FAN	UNTIL: 08.95; MOD: CBH320.34; - AC; - ENG-PTO		<b>9 PK 1290 TM</b>
<b>340.26</b>							
12024 ccm	247 kW	MIDR 06.35.40 G	02.88 - 10.92	AC-C	FROM: 06.88; MTR-CODE: MIDR 06.35.40 G; MOD: CBH 340.26; REQ: 2; - ENG-PTO		<b>AVX 13 x 1450 TM</b>
				AC-C	UNTIL: 05.88; MTR-CODE: MIDR 06.35.40 G; MOD: CBH 340.26; REQ: 2		<b>AVX 13 x 1450 TM</b>
				FAN	FROM: 06.88; MOD: CBH 340.26; REQ: 2		<b>AVX 13 x 1200 TM</b>
				FAN	FROM: 06.88; MTR-CODE: MIDR 06.35.40 G; MOD: CBH 340.26; REQ: 2; + ENG-PTO		<b>AVX 13 x 1550 TM</b>
				FAN	FROM: 10.92; MTR-CODE: MIDR 06.35.40 D; MOD: CBH 320; - AC; + ENG-PTO		<b>AVX 13 x 1550 TM</b>
				FAN	FROM: 10.92; MTR-CODE: MIDR 06.35.40 D; MOD: CBH 320; + AC		<b>AVX 13 x 1450 TM</b>
				ALT	FROM: 10.92; MTR-CODE: MIDR06.35.40D; MOD: CBH320; - AC; - ENG-PTO		<b>5 PK 1540 TM</b>
<b>340ti.17/T</b>							
9839 ccm	249 kW	MIDR 06.20.45 E;MIDR 06.20.45 E2;MIDR 06.20.45 E3	07.90 - 10.98	ALT	MTR-CODE: MIDR06.20.45E; MOD: C340ti.17/T		<b>5 PK 886</b>
<b>350.26</b>							
12024 ccm	259 kW	MIDR 06.35.40 G	05.90 - 01.93	FAN	MOD: 6X6;CBH 350.26; REQ: 2		<b>AVX 13 x 1200 TM</b>
				FAN	MOD: CBH 350.26; REQ: 2; - ENG-PTO		<b>AVX 13 x 1450 TM</b>
				FAN	MOD: CBH 350.26; REQ: 2; + ENG-PTO		<b>AVX 13 x 1550 TM</b>
<b>350.34</b>							
12024 ccm	259 kW	MIDR 06.35.40 G	05.90 - 01.93	FAN	MOD: 6X6;CBH 350.26; REQ: 2		<b>AVX 13 x 1200 TM</b>
				FAN	MOD: CBH 350.26; REQ: 2; - ENG-PTO		<b>AVX 13 x 1450 TM</b>
				FAN	MOD: CBH 350.26; REQ: 2; + ENG-PTO		<b>AVX 13 x 1550 TM</b>
<b>380.19/T</b>							
12024 ccm	275 kW	MIDR 06.35.40 H	05.91 - 10.92	FAN	MOD: 6X6;CLM 380.19;T; REQ: 2		<b>AVX 13 x 1200 TM</b>
				FAN	MOD: CLM 380.19;T; REQ: 2; - ENG-PTO		<b>AVX 13 x 1450 TM</b>
				FAN	MOD: CLM 380.19;T; REQ: 2; + ENG-PTO		<b>AVX 13 x 1550 TM</b>
<b>380.26</b>							
12024 ccm	275 kW	MIDR 06.35.40 H	01.90 - 10.92	FAN	MOD: 6X6;CBH 380.26; REQ: 2		<b>AVX 13 x 1200 TM</b>
				FAN	MOD: CBH 380.26; REQ: 2; - ENG-PTO		<b>AVX 13 x 1450 TM</b>
				FAN	MOD: CBH 380.26; REQ: 2; + ENG-PTO		<b>AVX 13 x 1550 TM</b>
<b>380.34</b>							
12024 ccm	275 kW	MIDR 06.35.40 H	01.90 - 10.92	FAN	MOD: 6X6;CBH 380.26; REQ: 2		<b>AVX 13 x 1200 TM</b>
				FAN	MOD: CBH 380.26; REQ: 2; - ENG-PTO		<b>AVX 13 x 1450 TM</b>
				FAN	MOD: CBH 380.26; REQ: 2; + ENG-PTO		<b>AVX 13 x 1550 TM</b>
<b>385.19/T</b>							
12024 ccm	283 kW	MIDR 06.35.40 N/3	10.92 - 10.98	AC-C	MTR-CODE: MIDR 06.35.40 N;3; MOD: CLM 385.19;T; REQ: 2; - ENG-PTO		<b>AVX 13 x 1125 TM</b>
				FAN	UNTIL: 08.95; MTR-CODE: MIDR 06.35.40 N;3; MOD: CLM 385.19;T; REQ: 2; - AC; + ENG-PTO		<b>AVX 13 x 1550 TM</b>
				FAN	UNTIL: 08.95; MTR-CODE: MIDR 06.35.40 N;3; MOD: CLM 385.19;T; REQ: 2; + AC; - ENG-PTO		<b>AVX 13 x 1450 TM</b>
				ALT	FROM: 09.95; MTR-CODE: MIDR06.35.40N;3; MOD: CLM385.19/T		<b>6 PK 1755 TM</b>
				ALT	UNTIL: 08.95; MTR-CODE: MIDR06.35.40N;3; MOD: CLM385.19/T; - AC; - ENG-PTO		<b>5 PK 1540 TM</b>
<b>385.22/T</b>							
12024 ccm	283 kW	MIDR 06.35.40 N/3	10.92 - 10.98	AC-C	MTR-CODE: MIDR 06.35.40 N;3; MOD: CLM 385.22;T; REQ: 2; - ENG-PTO		<b>AVX 13 x 1125 TM</b>
				FAN	UNTIL: 08.95; MTR-CODE: MIDR 06.35.40 N;3; MOD: CLM 385.22;T; REQ: 2; - AC; + ENG-PTO		<b>AVX 13 x 1550 TM</b>
				FAN	UNTIL: 08.95; MTR-CODE: MIDR 06.35.40 N;3; MOD: CLM 385.22;T; REQ: 2; + AC; - ENG-PTO		<b>AVX 13 x 1450 TM</b>
				ALT	FROM: 09.95; MTR-CODE: MIDR06.35.40N;3; MOD: CLM385.22/T		<b>6 PK 1755 TM</b>
				ALT	UNTIL: 08.95; MTR-CODE: MIDR06.35.40N;3; MOD: CLM385.22/T; - AC; - ENG-PTO		<b>5 PK 1540 TM</b>
<b>385.24</b>							
12024 ccm	283 kW	MIDR 06.35.40 N/3	10.92 - 10.98	AC-C	MTR-CODE: MIDR 06.35.40 N;3; MOD: CBH 385.24; REQ: 2; - ENG-PTO		<b>AVX 13 x 1125 TM</b>
				FAN	UNTIL: 08.95; MTR-CODE: MIDR 06.35.40 N;3; MOD: CBH 385.24; REQ: 2; - AC; + ENG-PTO		<b>AVX 13 x 1550 TM</b>

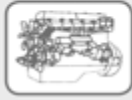

## RENAULT TRUCKS

C						
<b>385.24</b>						
12024 ccm	283 kW	MIDR 06.35.40 N/3	10.92 - 10.98	FAN	UNTIL: 08.95; MTR-CODE: MIDR 06.35.40 N;3; MOD: CBH 385.24; REQ: 2; + AC; - ENG-PTO	AVX 13 x 1175 TM
				FAN	UNTIL: 08.95; MTR-CODE: MIDR 06.35.40 N;3; MOD: CBH 385.24; REQ: 2; + AC; - ENG-PTO	AVX 13 x 1450 TM
				ALT	FROM: 09.95; MTR-CODE: MIDR06.35.40N;3; MOD: CBH385.24	6 PK 1755 TM
				ALT	UNTIL: 08.95; MTR-CODE: MIDR06.35.40N;3; MOD: CBH385.24; - AC; - ENG-PTO	5 PK 1540 TM
				FAN	FROM: 09.95; MTR-CODE: MIDR06.35.40N;3; MOD: CBH385.24; - ENG-PTO	9 PK 1290 TM
				FAN	UNTIL: 08.95; MTR-CODE: MIDR06.35.40N;3; MOD: CBH385.24; - AC; - ENG-PTO	9 PK 1290 TM
<b>385.25/T</b>						
12024 ccm	283 kW	MIDR 06.35.40 N/3	10.92 - 10.98	AC-C	MTR-CODE: MIDR 06.35.40 N;3; MOD: CLM 385.25;T; REQ: 2; - ENG-PTO	AVX 13 x 1125 TM
				FAN	UNTIL: 08.95; MTR-CODE: MIDR 06.35.40 N;3; MOD: CLM 385.25;T; REQ: 2; - AC; + ENG-PTO	AVX 13 x 1550 TM
				FAN	UNTIL: 08.95; MTR-CODE: MIDR 06.35.40 N;3; MOD: CLM 385.25;T; REQ: 2; + AC; - ENG-PTO	AVX 13 x 1450 TM
				ALT	FROM: 09.95; MTR-CODE: MIDR06.35.40N;3; MOD: CLM385.25/T	6 PK 1755 TM
				ALT	UNTIL: 08.95; MTR-CODE: MIDR06.35.40N;3; MOD: CLM385.25;T; - AC; - ENG-PTO	5 PK 1540 TM
<b>385.26</b>						
12024 ccm	283 kW	MIDR 06.35.40 N/3	10.92 - 10.98	AC-C	MTR-CODE: MIDR 06.35.40 N;3; MOD: CBH 385.26; REQ: 2; - ENG-PTO	AVX 13 x 1125 TM
				FAN	UNTIL: 08.95; MTR-CODE: MIDR 06.35.40 N;3; MOD: CBH 385.26; REQ: 2; - AC; + ENG-PTO	AVX 13 x 1550 TM
				FAN	UNTIL: 08.95; MTR-CODE: MIDR 06.35.40 N;3; MOD: CBH 385.26; REQ: 2; + AC; - ENG-PTO	AVX 13 x 1175 TM
				FAN	UNTIL: 08.95; MTR-CODE: MIDR 06.35.40 N;3; MOD: CBH 385.26; REQ: 2; + AC; - ENG-PTO	AVX 13 x 1450 TM
				ALT	FROM: 09.95; MTR-CODE: MIDR06.35.40N;3; MOD: CBH385.26	6 PK 1755 TM
				ALT	UNTIL: 08.95; MTR-CODE: MIDR06.35.40N;3; MOD: CBH385.26; - AC; - ENG-PTO	5 PK 1540 TM
				FAN	FROM: 09.95; MTR-CODE: MIDR06.35.40N;3; MOD: CBH385.26; - ENG-PTO	9 PK 1290 TM
				FAN	UNTIL: 08.95; MTR-CODE: MIDR06.35.40N;3; MOD: CBH385.26; - AC; - ENG-PTO	9 PK 1290 TM
<b>385.26/T</b>						
12024 ccm	283 kW	MIDR 06.35.40 N/3	10.92 - 10.98	AC-C	MTR-CODE: MIDR 06.35.40 N;3; MOD: CBH 385.26; REQ: 2; - ENG-PTO	AVX 13 x 1125 TM
				FAN	UNTIL: 08.95; MTR-CODE: MIDR 06.35.40 N;3; MOD: CBH 385.26; REQ: 2; - AC; + ENG-PTO	AVX 13 x 1550 TM
				FAN	UNTIL: 08.95; MTR-CODE: MIDR 06.35.40 N;3; MOD: CBH 385.26; REQ: 2; + AC; - ENG-PTO	AVX 13 x 1175 TM
				FAN	UNTIL: 08.95; MTR-CODE: MIDR 06.35.40 N;3; MOD: CBH 385.26; REQ: 2; + AC; - ENG-PTO	AVX 13 x 1450 TM
				ALT	FROM: 09.95; MTR-CODE: MIDR06.35.40N;3; MOD: CBH385.26	6 PK 1755 TM
				ALT	UNTIL: 08.95; MTR-CODE: MIDR06.35.40N;3; MOD: CBH385.26; - AC; - ENG-PTO	5 PK 1540 TM
				FAN	FROM: 09.95; MTR-CODE: MIDR06.35.40N;3; MOD: CBH385.26; - ENG-PTO	9 PK 1290 TM
				FAN	UNTIL: 08.95; MTR-CODE: MIDR06.35.40N;3; MOD: CBH385.26; - AC; - ENG-PTO	9 PK 1290 TM
<b>385.34</b>						
12024 ccm	283 kW	MIDR 06.35.40 N/3	10.92 - 10.98	AC-C	MTR-CODE: MIDR 06.35.40 N;3; MOD: CBH 385.34; REQ: 2; - ENG-PTO	AVX 13 x 1125 TM
				FAN	UNTIL: 08.95; MTR-CODE: MIDR 06.35.40 N;3; MOD: CBH 385.34; REQ: 2; - AC; + ENG-PTO	AVX 13 x 1550 TM
				FAN	UNTIL: 08.95; MTR-CODE: MIDR 06.35.40 N;3; MOD: CBH 385.34; REQ: 2; + AC; - ENG-PTO	AVX 13 x 1175 TM
				FAN	UNTIL: 08.95; MTR-CODE: MIDR 06.35.40 N;3; MOD: CBH 385.34; REQ: 2; + AC; - ENG-PTO	AVX 13 x 1450 TM
				ALT	FROM: 09.95; MTR-CODE: MIDR06.35.40N;3; MOD: CBH385.34	6 PK 1755 TM
				ALT	UNTIL: 08.95; MTR-CODE: MIDR06.35.40N;3; MOD: CBH385.34; - AC; - ENG-PTO	5 PK 1540 TM
				FAN	FROM: 09.95; MTR-CODE: MIDR06.35.40N;3; MOD: CBH385.34; - ENG-PTO	9 PK 1290 TM



## RENAULT TRUCKS

C						
<b>385.34</b>						
12024 ccm	283 kW	MIDR 06.35.40 N/3	10.92 - 10.98	FAN	UNTIL: 08.95; MTR-CODE: MIDR06.35.40N;3; MOD: CBH385.34; - AC; - ENG-PTO	<b>9 PK 1290 TM</b>
<b>385.34/T</b>						
12024 ccm	283 kW	MIDR 06.35.40 N/3	10.92 - 10.98	AC-C	MTR-CODE: MIDR 06.35.40 N;3; MOD: CBH 385.34; REQ: 2; - ENG-PTO	<b>AVX 13 x 1125 TM</b>
				FAN	UNTIL: 08.95; MTR-CODE: MIDR 06.35.40 N;3; MOD: CBH 385.34; REQ: 2; + AC; + ENG-PTO	<b>AVX 13 x 1550 TM</b>
				FAN	UNTIL: 08.95; MTR-CODE: MIDR 06.35.40 N;3; MOD: CBH 385.34; REQ: 2; + AC; - ENG-PTO	<b>AVX 13 x 1175 TM</b>
				FAN	UNTIL: 08.95; MTR-CODE: MIDR 06.35.40 N;3; MOD: CBH 385.34; REQ: 2; + AC; - ENG-PTO	<b>AVX 13 x 1450 TM</b>
				ALT	FROM: 09.95; MTR-CODE: MIDR06.35.40N;3; MOD: CBH385.34	<b>6 PK 1755 TM</b>
				ALT	UNTIL: 08.95; MTR-CODE: MIDR06.35.40N;3; MOD: CBH385.34; - AC; - ENG-PTO	<b>5 PK 1540 TM</b>
				FAN	FROM: 09.95; MTR-CODE: MIDR06.35.40N;3; MOD: CBH385.34; - ENG-PTO	<b>9 PK 1290 TM</b>
				FAN	UNTIL: 08.95; MTR-CODE: MIDR06.35.40N;3; MOD: CBH385.34; - AC; - ENG-PTO	<b>9 PK 1290 TM</b>
<b>Kerax</b>						
<b>260.18</b>						
9839 ccm	188 kW	MIDR 06.20.45 C/4	06.97 -	AC-C	MTR-CODE: MIDR 06.20.45 C;4; MOD: 260.18;260.18;B	<b>AVX 13 x 1225 TM</b>
				ALT	MTR-CODE: MIDR06.20.45C;4; MOD: 260.18;260.18;B	<b>6 PK 1065 TM</b>
<b>260.18/B</b>						
9839 ccm	188 kW	MIDR 06.20.45 C/4	06.97 -	AC-C	MTR-CODE: MIDR 06.20.45 C;4; MOD: 260.18;260.18;B	<b>AVX 13 x 1225 TM</b>
				ALT	MTR-CODE: MIDR06.20.45C;4; MOD: 260.18;260.18;B	<b>6 PK 1065 TM</b>
<b>300.18/B</b>						
9839 ccm	219 kW	MIDR 06.20.45 D/41	06.97 -	AC-C	MTR-CODE: MIDR 06.20.45 D;41; MOD: 300.18;B	<b>AVX 13 x 1225 TM</b>
				ALT	MTR-CODE: MIDR06.20.45D;41; MOD: 300.18;B	<b>6 PK 1065 TM</b>
<b>300.26/A; 300.26/B</b>						
9839 ccm	219 kW	MIDR 06.20.45 D/41	06.97 -	AC-C	MTR-CODE: MIDR 06.20.45 D;41; MOD: 300.26;A;300.26;B	<b>AVX 13 x 1225 TM</b>
				ALT	MTR-CODE: MIDR06.20.45D;41; MOD: 300.26;A;300.26;B	<b>6 PK 1065 TM</b>
<b>320.26</b>						
11100 ccm	230 kW	dCi 11G	01.01 -	AC-C	MOD: 320.26; REQ: 2; - AMP: 80	<b>AVX 13 x 1225 TM</b>
				AC-C	FROM: 05.02; MOD: 320.26	<b>5 PK 1260 TM</b>
				AC-C	UNTIL: 05.02; MOD: 320.26	<b>5 PK 1240 TM</b>
				ALT	AMP: 35,4; MOD: 320.26	<b>6 PK 1065 TM</b>
				ALT	AMP: 80; MOD: 320.26	<b>5 PK 1025 TM</b>
<b>340.18</b>						
9839 ccm	249 kW	MIDR 06.20.45 E/41	06.97 -	AC-C	MTR-CODE: MIDR 06.20.45 E;41; MOD: 340.18;340.18;B	<b>AVX 13 x 1225 TM</b>
				ALT	MTR-CODE: MIDR06.20.45E;41; MOD: 340.18;340.18;B	<b>6 PK 1065 TM</b>
<b>340.18/B</b>						
9839 ccm	249 kW	MIDR 06.20.45 E/41	06.97 -	AC-C	MTR-CODE: MIDR 06.20.45 E;41; MOD: 340.18;340.18;B	<b>AVX 13 x 1225 TM</b>
				ALT	MTR-CODE: MIDR06.20.45E;41; MOD: 340.18;340.18;B	<b>6 PK 1065 TM</b>
<b>340.26</b>						
9839 ccm	249 kW	MIDR 06.20.45 E/41	06.97 - 01.01	AC-C	MTR-CODE: MIDR 06.20.45 E;41; MOD: 340.26;340.26	<b>AVX 13 x 1225 TM</b>
				ALT	MTR-CODE: MIDR06.20.45E;41; MOD: 340.26;340.26	<b>6 PK 1065 TM</b>
<b>340.26/A; 340.26/B</b>						
9839 ccm	249 kW	MIDR 06.20.45 E/41	06.97 -	AC-C	MTR-CODE: MIDR 06.20.45 E;41; MOD: 340.26;340.26	<b>AVX 13 x 1225 TM</b>
				ALT	MTR-CODE: MIDR06.20.45E;41; MOD: 340.26;340.26	<b>6 PK 1065 TM</b>
<b>340.32/A</b>						
9839 ccm	249 kW	MIDR 06.20.45 E/41	06.97 -	AC-C	MTR-CODE: MIDR 06.20.45 E;41; MOD: 340.32;A	<b>AVX 13 x 1225 TM</b>
				ALT	MTR-CODE: MIDR06.20.45E;41; MOD: 340.32/A	<b>6 PK 1065 TM</b>



## RENAULT TRUCKS

### Kerax

#### 370.18

11100 ccm	266 kW	dCi 11E	01.01 -	AC-C	MOD: 370.18; REQ: 2; - AMP: 80	AVX 13 x 1225 TM
				AC-C	FROM: 05.02; MOD: 370.18	5 PK 1260 TM
				AC-C	UNTIL: 05.02; MOD: 370.18	5 PK 1240 TM
				ALT	AMP: 35,4; MOD: 370.18	6 PK 1065 TM
				ALT	AMP: 80; MOD: 370.18; - AC	5 PK 1025 TM

#### 370.26

11100 ccm	266 kW	dCi 11E	01.01 -	AC-C	MOD: 370.26; REQ: 2; - AMP: 80	AVX 13 x 1225 TM
				AC-C	FROM: 05.02; MOD: 370.26	5 PK 1260 TM
				AC-C	UNTIL: 05.02; MOD: 370.26	5 PK 1240 TM
				ALT	AMP: 35,4; MOD: 370.26	6 PK 1065 TM
				ALT	AMP: 80; MOD: 370.26	5 PK 1025 TM

#### 370.32

11100 ccm	266 kW	dCi 11E	01.01 -	AC-C	MOD: 370.32; REQ: 2; - AMP: 80	AVX 13 x 1225 TM
				AC-C	FROM: 05.02; MOD: 370.32	5 PK 1260 TM
				AC-C	UNTIL: 05.02; MOD: 370.32	5 PK 1240 TM
				ALT	AMP: 35,4; MOD: 370.32	6 PK 1065 TM
				ALT	AMP: 80; MOD: 370.32	5 PK 1025 TM

#### 385.18

11100 ccm	280 kW	MIDR 06.23.56 A/41	06.97 -	AC-C	MTR-CODE: MIDR 06.23.56 A;41; MOD: 385.18;385.18;B	AVX 13 x 1225 TM
				ALT	MTR-CODE: MIDR06.23.56A;41; MOD: 385.18;385.18;B	6 PK 1065 TM

#### 385.18/B

11100 ccm	280 kW	MIDR 06.23.56 A/41	06.97 -	AC-C	MTR-CODE: MIDR 06.23.56 A;41; MOD: 385.18;385.18;B	AVX 13 x 1225 TM
				ALT	MTR-CODE: MIDR06.23.56A;41; MOD: 385.18;385.18;B	6 PK 1065 TM

#### 385.18T

11100 ccm	280 kW	MIDR 06.23.56 A/41	06.97 -	AC-C	MTR-CODE: MIDR 06.23.56 A;41; MOD: 385.18;385.18;B	AVX 13 x 1225 TM
				ALT	MTR-CODE: MIDR06.23.56A;41; MOD: 385.18;385.18;B	6 PK 1065 TM

#### 385.26/A; 385.26/B; 385.26/C

11100 ccm	280 kW	MIDR 06.23.56 A/41	06.97 -	AC-C	MTR-CODE: MIDR 06.23.56 A;41; MOD: 385.26;A;385.26	AVX 13 x 1225 TM
				ALT	MTR-CODE: MIDR06.23.56A;41; MOD: 385.26;A;385.26	6 PK 1065 TM

#### 385.26T

11100 ccm	280 kW	MIDR 06.23.56 A/41	06.97 -	AC-C	MTR-CODE: MIDR 06.23.56 A;41; MOD: 385.26;A;385.26	AVX 13 x 1225 TM
				ALT	MTR-CODE: MIDR06.23.56A;41; MOD: 385.26;A;385.26	6 PK 1065 TM

#### 385.32/A; 385.32/B; 385.32/C

11100 ccm	280 kW	MIDR 06.23.56 A/41	06.97 -	AC-C	MTR-CODE: MIDR 06.23.56 A;41; MOD: 385.32;A;385.32	AVX 13 x 1225 TM
				ALT	MTR-CODE: MIDR06.23.56A;41; MOD: 385.32;A;385.32	6 PK 1065 TM

#### 420.18

11100 ccm	303 kW	dCi 11C	01.01 -	AC-C	MOD: 420.18; REQ: 2; - AMP: 80	AVX 13 x 1225 TM
				AC-C	FROM: 05.02; MOD: 420.18	5 PK 1260 TM
				AC-C	UNTIL: 05.02; MOD: 420.18	5 PK 1240 TM
				ALT	AMP: 35,4; MOD: 420.18	6 PK 1065 TM
				ALT	AMP: 80; MOD: 420.18	5 PK 1025 TM

#### 420.26

11100 ccm	303 kW	dCi 11C	01.01 -	AC-C	MOD: 420.18; REQ: 2; - AMP: 80	AVX 13 x 1225 TM
				AC-C	MOD: 420.26; REQ: 2; - AMP: 80	AVX 13 x 1225 TM
				AC-C	FROM: 05.02; MOD: 420.18	5 PK 1260 TM
				AC-C	FROM: 05.02; MOD: 420.26	5 PK 1260 TM
				AC-C	UNTIL: 05.02; MOD: 420.18	5 PK 1240 TM
				AC-C	UNTIL: 05.02; MOD: 420.26	5 PK 1240 TM
				ALT	AMP: 35,4; MOD: 420.18	6 PK 1065 TM
				ALT	AMP: 35,4; MOD: 420.26	6 PK 1065 TM
				ALT	AMP: 80; MOD: 420.18	5 PK 1025 TM
				ALT	AMP: 80; MOD: 420.26	5 PK 1025 TM

#### 420.32

11100 ccm	303 kW	dCi 11C	10.01 -	AC-C	MOD: 420.32; REQ: 2; - AMP: 80	AVX 13 x 1225 TM
				AC-C	FROM: 05.02; MOD: 420.32	5 PK 1260 TM
				AC-C	UNTIL: 05.02; MOD: 420.32	5 PK 1240 TM

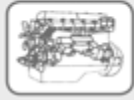

## RENAULT TRUCKS

### Kerax

<b>420.32</b>						
11100 ccm	303 kW	dCi 11C	10.01 -	ALT	AMP: 35,4; MOD: 420.32	<b>6 PK 1065 TM</b>
				ALT	AMP: 80; MOD: 420.32	<b>5 PK 1025 TM</b>
<b>420.34</b>						
11100 ccm	303 kW	dCi 11C	01.01 -	AC-C	MOD: 420.34; REQ: 2; - AMP: 80	<b>AVX 13 x 1225 TM</b>
				AC-C	FROM: 05.02; MOD: 420.34	<b>5 PK 1260 TM</b>
				AC-C	UNTIL: 05.02; MOD: 420.34	<b>5 PK 1240 TM</b>
				ALT	AMP: 35,4; MOD: 420.34	<b>6 PK 1065 TM</b>
				ALT	AMP: 80; MOD: 420.34	<b>5 PK 1025 TM</b>

### Major

<b>340ti.16/T</b>						
9839 ccm	249 kW	MIDR 06.20.45 E;MIDR 06.20.45 E2;MIDR 06.20.45 E3	05.91 - 10.96	AC-C	MTR-CODE: MIDR 06.20.45 E; MOD: R 340ti.16;T	<b>AVX 13 x 1400 TM</b>
				ALT	MTR-CODE: MIDR06.20.45E; MOD: R340ti.16/T	<b>5 PK 1010 TM</b>
<b>340ti.17</b>						
9839 ccm	249 kW	MIDR 06.20.45 E;MIDR 06.20.45 E2;MIDR 06.20.45 E3	05.91 - 10.96	AC-C	MTR-CODE: MIDR 06.20.45 E; MOD: R 340ti.17	<b>AVX 13 x 1400 TM</b>
				ALT	MTR-CODE: MIDR06.20.45E; MOD: R340ti.17	<b>5 PK 1010 TM</b>
<b>340ti.18</b>						
9839 ccm	249 kW	MIDR 06.20.45 E;MIDR 06.20.45 E2;MIDR 06.20.45 E3	05.91 - 10.96	AC-C	MTR-CODE: MIDR 06.20.45 E; MOD: R 340ti.18	<b>AVX 13 x 1400 TM</b>
				ALT	MTR-CODE: MIDR06.20.45E; MOD: R340ti.18	<b>5 PK 1010 TM</b>
<b>340ti.18/T</b>						
9839 ccm	249 kW	MIDR 06.20.45 E;MIDR 06.20.45 E2;MIDR 06.20.45 E3	05.91 - 10.96	AC-C	MTR-CODE: MIDR 06.20.45 E; MOD: R 340ti.18	<b>AVX 13 x 1400 TM</b>
				ALT	MTR-CODE: MIDR06.20.45E; MOD: R340ti.18	<b>5 PK 1010 TM</b>
<b>340ti.19</b>						
9839 ccm	249 kW	MIDR 06.20.45 E;MIDR 06.20.45 E2;MIDR 06.20.45 E3	05.91 - 10.96	AC-C	MTR-CODE: MIDR 06.20.45 E; MOD: R 340ti.19	<b>AVX 13 x 1400 TM</b>
				ALT	MTR-CODE: MIDR06.20.45E; MOD: R340ti.19	<b>5 PK 1010 TM</b>
<b>340ti.19/T</b>						
9839 ccm	249 kW	MIDR 06.20.45 E;MIDR 06.20.45 E2;MIDR 06.20.45 E3	05.91 - 10.96	AC-C	MTR-CODE: MIDR 06.20.45 E; MOD: R 340ti.19	<b>AVX 13 x 1400 TM</b>
				ALT	MTR-CODE: MIDR06.20.45E; MOD: R340ti.19	<b>5 PK 1010 TM</b>
<b>340ti.24</b>						
9839 ccm	249 kW	MIDR 06.20.45 E;MIDR 06.20.45 E2;MIDR 06.20.45 E3	05.91 - 10.96	AC-C	MTR-CODE: MIDR 06.20.45 E; MOD: R 340ti.24	<b>AVX 13 x 1400 TM</b>
				ALT	MTR-CODE: MIDR06.20.45E; MOD: R340ti.24	<b>5 PK 1010 TM</b>
<b>340ti.26</b>						
9839 ccm	249 kW	MIDR 06.20.45 E;MIDR 06.20.45 E2;MIDR 06.20.45 E3	05.91 - 10.96	AC-C	MTR-CODE: MIDR 06.20.45 E; MOD: R 340ti.26	<b>AVX 13 x 1400 TM</b>
				ALT	MTR-CODE: MIDR06.20.45E; MOD: R340ti.26	<b>5 PK 1010 TM</b>
<b>350.17</b>						
12024 ccm	259 kW	MIDR 06.35.40 G	05.91 - 12.92	AC-C	MOD: R 350.17;R 350.17;T	<b>AVX 13 x 1225 TM</b>
				FAN	MOD: R 350.17;R 350.17;T; REQ: 2	<b>AVX 13 x 1200 TM</b>
<b>350.17/T</b>						
12024 ccm	259 kW	MIDR 06.35.40 G	05.91 - 12.92	AC-C	MOD: R 350.17;R 350.17;T	<b>AVX 13 x 1225 TM</b>
				FAN	MOD: R 350.17;R 350.17;T; REQ: 2	<b>AVX 13 x 1200 TM</b>
<b>350.18</b>						
12024 ccm	259 kW	MIDR 06.35.40 G	05.91 - 12.92	AC-C	MOD: R 350.18;R 350.18;T	<b>AVX 13 x 1225 TM</b>
				FAN	MOD: R 350.18;R 350.18;T; REQ: 2	<b>AVX 13 x 1200 TM</b>
<b>350.18/T</b>						
12024 ccm	259 kW	MIDR 06.35.40 G	05.91 - 12.92	AC-C	MOD: R 350.18;R 350.18;T	<b>AVX 13 x 1225 TM</b>
				FAN	MOD: R 350.18;R 350.18;T; REQ: 2	<b>AVX 13 x 1200 TM</b>
<b>350.19</b>						
12024 ccm	259 kW	MIDR 06.35.40 G	05.91 - 12.92	AC-C	MTR-CODE: MIDR 06.35.40 G; MOD: R 350.19;R 350.19;T	<b>AVX 13 x 1225 TM</b>
				AC-C	MTR-CODE: MIDR 06.35.40 G; MOD: R 350.19;R 350.19;TB	<b>AVX 13 x 1225 TM</b>
				FAN	MTR-CODE: MIDR 06.35.40 G; MOD: R 350.19;R 350.19;T; REQ: 2	<b>AVX 13 x 1200 TM</b>
				FAN	MTR-CODE: MIDR 06.35.40 G; MOD: R 350.19;R 350.19;TB; REQ: 2	<b>AVX 13 x 1200 TM</b>
<b>350.19/T</b>						
12024 ccm	259 kW	MIDR 06.35.40 G	05.91 - 12.92	AC-C	MOD: R 350.19;R 350.19;T	<b>AVX 13 x 1225 TM</b>
				FAN	MOD: R 350.19;R 350.19;T; REQ: 2	<b>AVX 13 x 1200 TM</b>



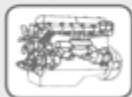

## RENAULT TRUCKS

### Major

#### 350.19/TB

12024 ccm	259 kW	MIDR 06.35.40 G	05.91 - 12.92	AC-C FAN	MOD: R 350.19;R 350.19;TB MOD: R 350.19;R 350.19;TB; REQ: 2	AVX 13 x 1225 TM AVX 13 x 1200 TM
-----------	--------	-----------------	---------------	-------------	--	--------------------------------------

#### 350.24

12024 ccm	259 kW	MIDR 06.35.40 G	05.91 - 10.92	AC-C FAN	MOD: R 350.24 MOD: R 350.24; REQ: 2	AVX 13 x 1225 TM AVX 13 x 1200 TM
-----------	--------	-----------------	---------------	-------------	--	--------------------------------------

#### 350.26

12024 ccm	259 kW	MIDR 06.35.40 G	05.91 - 12.92	AC-C FAN	MOD: R 350.26 MOD: R 350.26; REQ: 2	AVX 13 x 1225 TM AVX 13 x 1200 TM
-----------	--------	-----------------	---------------	-------------	--	--------------------------------------

#### 380.22/T

12024 ccm	275 kW	MIDR 06.35.40 H	05.91 - 12.92	AC-C FAN	MOD: R 380.22;T MOD: R 380.22;T; REQ: 2	AVX 13 x 1225 TM AVX 13 x 1175 TM
-----------	--------	-----------------	---------------	-------------	--	--------------------------------------

#### 380.25

12024 ccm	275 kW	MIDR 06.35.40 H	05.91 - 12.92	AC-C FAN	MOD: R 380.25 MOD: R 380.25; REQ: 2	AVX 13 x 1225 TM AVX 13 x 1175 TM
-----------	--------	-----------------	---------------	-------------	--	--------------------------------------

#### 385ti.17; 380.17

12024 ccm	275-283 kW	MIDR 06.35.40 H;MIDR 06.35.40 L1;MIDR 06.35.40 N/3	05.91 - 10.96	AC-C	FROM: 09.95; MTR-CODE: MIDR 06.35.40 H; MOD: R 385ti.17;R 380.17	AVX 13 x 1125 TM
				FAN	UNTIL: 08.95; MTR-CODE: MIDR 06.35.40 H; MOD: R 385ti.17;R 380.17	AVX 13 x 1200 TM
				ALT	FROM: 09.95; MTR-CODE: MIDR06.35.40H; MOD: R385ti.17,R380.17	6 PK 1755 TM
				ALT	UNTIL: 08.95; MTR-CODE: MIDR06.35.40H; MOD: R385ti.17,R380.17	5 PK 1540 TM

#### 385ti.18/T; 380.18/T

12024 ccm	275-283 kW	MIDR 06.35.40 H;MIDR 06.35.40 L1;MIDR 06.35.40 N/3	05.91 - 10.96	AC-C	FROM: 09.95; MTR-CODE: MIDR 06.35.40 H; MOD: R 385ti.18;R 380.18	AVX 13 x 1125 TM
				FAN	UNTIL: 08.95; MTR-CODE: MIDR 06.35.40 H; MOD: R 385ti.18;R 380.18	AVX 13 x 1200 TM
				ALT	FROM: 09.95; MTR-CODE: MIDR06.35.40H; MOD: R385ti.18,R380.18	6 PK 1755 TM
				ALT	UNTIL: 08.95; MTR-CODE: MIDR06.35.40H; MOD: R385ti.18,R380.18	5 PK 1540 TM
				FAN	MTR-CODE: MIDR 06.35.40 H; MOD: Major;R 385ti.18;R 380.18	9 PK 1200 TM

#### 385ti.18; 380.18

12024 ccm	275-283 kW	MIDR 06.35.40 H;MIDR 06.35.40 L1;MIDR 06.35.40 N/3	05.91 - 10.96	AC-C	FROM: 09.95; MTR-CODE: MIDR 06.35.40 H; MOD: R 385ti.18;R 380.18	AVX 13 x 1125 TM
				FAN	UNTIL: 08.95; MTR-CODE: MIDR 06.35.40 H; MOD: R 385ti.18;R 380.18	AVX 13 x 1200 TM
					MTR-CODE: MIDR 06.35.40 H; MOD: Major;R 385ti.;R 380.18	8 PK 1956 TM
					MTR-CODE: MIDR 06.65.40H; MOD: Mayor;R 385t1.18;R 380.18	9 PK 1200 TM
				ALT	FROM: 09.95; MTR-CODE: MIDR06.35.40H; MOD: R385ti.18,R380.18	6 PK 1755 TM
				ALT	UNTIL: 08.95; MTR-CODE: MIDR06.35.40H; MOD: R385ti.18,R380.18	5 PK 1540 TM

#### 385ti.19/T; 380.19/T

12024 ccm	275-283 kW	MIDR 06.35.40 H;MIDR 06.35.40 L1;MIDR 06.35.40 N/3	05.91 - 10.96	AC-C	FROM: 09.95; MTR-CODE: MIDR 06.35.40 H; MOD: R 385ti.19;R 380.19	AVX 13 x 1125 TM
				FAN	UNTIL: 08.95; MTR-CODE: MIDR 06.35.40 H; MOD: R 385ti.19;R 380.19	AVX 13 x 1200 TM
				ALT	FROM: 09.95; MTR-CODE: MIDR06.35.40H; MOD: R385ti.19,R380.19	6 PK 1755 TM
				ALT	UNTIL: 08.95; MTR-CODE: MIDR06.35.40H; MOD: R385ti.19,R380.19	5 PK 1540 TM

#### 385ti.19; 380.19

12024 ccm	275-283 kW	MIDR 06.35.40 H;MIDR 06.35.40 L1;MIDR 06.35.40 N/3	05.91 - 10.96	AC-C	FROM: 09.95; MTR-CODE: MIDR 06.35.40 H; MOD: R 385ti.19;R 380.19	AVX 13 x 1125 TM
				FAN	UNTIL: 08.95; MTR-CODE: MIDR 06.35.40 H; MOD: R 385ti.19;R 380.19	AVX 13 x 1200 TM
				ALT	FROM: 09.95; MTR-CODE: MIDR06.35.40H; MOD: R385ti.19,R380.19	6 PK 1755 TM
				ALT	UNTIL: 08.95; MTR-CODE: MIDR06.35.40H; MOD: R385ti.19,R380.19	5 PK 1540 TM

#### 385ti.22/T; 380.19/TB

12024 ccm	275-283 kW	MIDR 06.35.40 H;MIDR 06.35.40 L1;MIDR 06.35.40 N/3	05.91 - 10.96	AC-C	FROM: 09.95; MTR-CODE: MIDR 06.35.40 H; MOD: R 385ti.22	AVX 13 x 1125 TM
-----------	------------	--	---------------	------	--	------------------

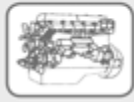

## RENAULT TRUCKS

Major							
<b>385ti.22/T; 380.19/TB</b>							
12024 ccm	275-283 kW	MIDR 06.35.40 H;MIDR 06.35.40 L1;MIDR 06.35.40 N/3	05.91 - 10.96	FAN	UNTIL: 08.95; MTR-CODE: MIDR 06.35.40 H; MOD: R 385ti.22	AVX 13 x 1200 TM	
				ALT	FROM: 09.95; MTR-CODE: MIDR06.35.40H; MOD: R385ti.22	6 PK 1755 TM	
				ALT	UNTIL: 08.95; MTR-CODE: MIDR06.35.40H; MOD: R385ti.22	5 PK 1540 TM	
<b>385ti.24; 380.24</b>							
12024 ccm	275-283 kW	MIDR 06.35.40 H;MIDR 06.35.40 L1;MIDR 06.35.40 N/3	05.91 - 10.96	AC-C	FROM: 09.95; MTR-CODE: MIDR 06.35.40 H; MOD: R 385ti.24;R 380.24	AVX 13 x 1125 TM	
				FAN	UNTIL: 08.95; MTR-CODE: MIDR 06.35.40 H; MOD: R 385ti.24;R 380.24	AVX 13 x 1200 TM	
				ALT	FROM: 09.95; MTR-CODE: MIDR06.35.40H; MOD: R385ti.24,R380.24	6 PK 1755 TM	
				ALT	UNTIL: 08.95; MTR-CODE: MIDR06.35.40H; MOD: R385ti.24,R380.24	5 PK 1540 TM	
				FAN	MTR-CODE: MIDR 06.35.40 H; MOD: Major;R 385ti.24;R 380.24	9 PK 1200 TM	
<b>385ti.25/T; 380.25/T</b>							
12024 ccm	275-283 kW	MIDR 06.35.40 H;MIDR 06.35.40 L1;MIDR 06.35.40 N/3	05.91 - 10.96	AC-C	FROM: 09.95; MTR-CODE: MIDR 06.35.40 H; MOD: R 385ti.25;R 380.25	AVX 13 x 1125 TM	
				FAN	UNTIL: 08.95; MTR-CODE: MIDR 06.35.40 H; MOD: R 385ti.25;R 380.25	AVX 13 x 1200 TM	
				ALT	FROM: 09.95; MTR-CODE: MIDR06.35.40H; MOD: R385ti.25,R380.25	6 PK 1755 TM	
				ALT	UNTIL: 08.95; MTR-CODE: MIDR06.35.40H; MOD: R385ti.25,R380.25	5 PK 1540 TM	
				FAN	MTR-CODE: MIDR 06.35.40 H; MOD: Major;R 385ti.25;R 380.25	9 PK 1200 TM	
<b>385ti.25; 380.25</b>							
12024 ccm	275-283 kW	MIDR 06.35.40 H;MIDR 06.35.40 L1;MIDR 06.35.40 N/3	05.91 - 10.96	AC-C	FROM: 09.95; MTR-CODE: MIDR 06.35.40 H; MOD: R 385ti.25;R 380.25	AVX 13 x 1125 TM	
				FAN	UNTIL: 08.95; MTR-CODE: MIDR 06.35.40 H; MOD: R 385ti.25;R 380.25	AVX 13 x 1200 TM	
				ALT	FROM: 09.95; MTR-CODE: MIDR06.35.40H; MOD: R385ti.25,R380.25	6 PK 1755 TM	
				ALT	UNTIL: 08.95; MTR-CODE: MIDR06.35.40H; MOD: R385ti.25,R380.25	5 PK 1540 TM	
				FAN	MTR-CODE: MIDR 06.35.40 H; MOD: Major;R 385ti.25;R 380.25	9 PK 1200 TM	
<b>385ti.26</b>							
12024 ccm	283 kW	MIDR 06.35.40 L1;MIDR 06.35.40 N/3	12.91 - 10.96	AC-C	FROM: 09.95; MTR-CODE: MIDR 06.35.40 L1; MOD: R 385ti.26	AVX 13 x 1125 TM	
				FAN	UNTIL: 08.95; MTR-CODE: MIDR 06.35.40 L1; MOD: R 385ti.26	AVX 13 x 1200 TM	
				ALT	FROM: 09.95; MTR-CODE: MIDR06.35.40L1; MOD: R385ti.26	6 PK 1755 TM	
				ALT	UNTIL: 08.95; MTR-CODE: MIDR06.35.40L1; MOD: R385ti.26	5 PK 1540 TM	
				FAN	MTR-CODE: MIDR 06.35.40 L1; MOD: Major;R 385ti.26	9 PK 1200 TM	
<b>385ti.26/T; 380.26/T</b>							
12024 ccm	275-283 kW	MIDR 06.35.40 H;MIDR 06.35.40 L1;MIDR 06.35.40 N/3	05.91 - 10.96	AC-C	FROM: 09.95; MTR-CODE: MIDR 06.35.40 H; MOD: R 385ti.26;R 380.26	AVX 13 x 1125 TM	
				FAN	UNTIL: 08.95; MTR-CODE: MIDR 06.35.40 H; MOD: R 385ti.26;R 380.26	AVX 13 x 1200 TM	
					MTR-CODE: MIDR 06.35.40 H; MOD: Major;R 385ti.26;R 380.26	9 PK 1200 TM	
				ALT	FROM: 09.95; MTR-CODE: MIDR06.35.40H; MOD: R385ti.26,R380.26	6 PK 1755 TM	
				ALT	UNTIL: 08.95; MTR-CODE: MIDR06.35.40H; MOD: R385ti.26,R380.26	5 PK 1540 TM	
<b>385ti.26; 380.26</b>							
12024 ccm	275-283 kW	MIDR 06.35.40 H;MIDR 06.35.40 L1;MIDR 06.35.40 N/3	05.91 - 10.96	AC-C	FROM: 09.95; MTR-CODE: MIDR 06.35.40 H; MOD: R 385ti.26;R 380.26	AVX 13 x 1125 TM	
				FAN	UNTIL: 08.95; MTR-CODE: MIDR 06.35.40 H; MOD: R 385ti.26;R 380.26	AVX 13 x 1200 TM	
				ALT	FROM: 09.95; MTR-CODE: MIDR06.35.40H; MOD: R385ti.26,R380.26	6 PK 1755 TM	
				ALT	UNTIL: 08.95; MTR-CODE: MIDR06.35.40H; MOD: R385ti.26,R380.26	5 PK 1540 TM	
				FAN	MTR-CODE: MIDR 06.35.40 H; MOD: Major;R 385ti.26;R 380.26	9 PK 1200 TM	



## RENAULT TRUCKS

### Major

#### 420ti.18/T

12024 ccm	305 kW	MIDR 06.35.40 J/3	10.92 - 10.96	AC-C	FROM: 09.95; MTR-CODE: MIDR 06.35.40 J;3; MOD: R 420ti.18;T	AVX 13 x 1125 TM
				FAN	UNTIL: 08.95; MTR-CODE: MIDR 06.35.40 J;3; MOD: R 420ti.18;T	AVX 13 x 1200 TM
				ALT	FROM: 09.95; MTR-CODE: MIDR06.35.40J;3; MOD: R420ti.18/T	6 PK 1755 TM
				ALT	UNTIL: 08.95; MTR-CODE: MIDR06.35.40J;3; MOD: R420ti.18/T	5 PK 1540 TM
				FAN	MTR-CODE: MIDR 06.35.40 J/3; MOD: Major;R 420ti.18/T	9 PK 1200 TM

#### 420ti.19/T

12024 ccm	305 kW	MIDR 06.35.40 J/3	10.92 - 10.96	AC-C	FROM: 09.95; MTR-CODE: MIDR 06.35.40 J;3; MOD: R 420ti.19;T	AVX 13 x 1125 TM
				FAN	UNTIL: 08.95; MTR-CODE: MIDR 06.35.40 J;3; MOD: R 420ti.19;T	AVX 13 x 1200 TM
				ALT	FROM: 09.95; MTR-CODE: MIDR06.35.40J;3; MOD: R420ti.19/T	6 PK 1755 TM
				ALT	UNTIL: 08.95; MTR-CODE: MIDR06.35.40J;3; MOD: R420ti.19/T	5 PK 1540 TM

#### 420ti.22/T

12024 ccm	305 kW	MIDR 06.35.40 J/3	10.92 - 10.96	AC-C	FROM: 09.95; MTR-CODE: MIDR 06.35.40 J;3; MOD: R 420ti.22;T	AVX 13 x 1125 TM
				FAN	UNTIL: 08.95; MTR-CODE: MIDR 06.35.40 J;3; MOD: R 420ti.22;T	AVX 13 x 1200 TM
				ALT	FROM: 09.95; MTR-CODE: MIDR06.35.40J;3; MOD: R420ti.22/T	6 PK 1755 TM
				ALT	UNTIL: 08.95; MTR-CODE: MIDR06.35.40J;3; MOD: R420ti.22/T	5 PK 1540 TM

#### 420ti.24/TS

12024 ccm	305-314 kW	MIDR 06.35.40 J/3;MIDR 06.35.40 J1	04.92 - 10.96	AC-C	FROM: 09.95; MTR-CODE: MIDR 06.35.40 J;3; MOD: R 420ti.24;TS	AVX 13 x 1125 TM
				FAN	UNTIL: 08.95; MTR-CODE: MIDR 06.35.40 J;3; MOD: R 420ti.24;TS	AVX 13 x 1200 TM
				ALT	FROM: 09.95; MOD: R420ti.24/TS	6 PK 1755 TM
				ALT	UNTIL: 08.95; MOD: R420ti.24/TS	5 PK 1540 TM
				FAN	MTR-CODE: MIDR 06.35.40 J/3; MOD: Major;R 420ti.24T/S	9 PK 1200 TM

#### 420ti.26/TS

12024 ccm	305-314 kW	MIDR 06.35.40 J/3;MIDR 06.35.40 J1	04.92 - 10.96	AC-C	FROM: 09.95; MTR-CODE: MIDR 06.35.40 J;3; MOD: R 420ti.26;TS	AVX 13 x 1125 TM
				FAN	UNTIL: 08.95; MTR-CODE: MIDR 06.35.40 J;3; MOD: R 420ti.26;TS	AVX 13 x 1200 TM
				ALT	FROM: 09.95; MOD: R420ti.26/TS	6 PK 1755 TM
				ALT	UNTIL: 08.95; MOD: R420ti.26/TS	5 PK 1540 TM
				FAN	MTR-CODE: MIDR 06.35.40 J/3; MOD: Major;R 420ti.26/TS	9 PK 1200 TM

#### 420ti.35/TS

12024 ccm	305 kW	MIDR 06.35.40 J/3	04.92 - 10.96	AC-C	FROM: 09.95; MTR-CODE: MIDR 06.35.40 J;3; MOD: R 420ti.35;TS	AVX 13 x 1125 TM
				FAN	UNTIL: 08.95; MTR-CODE: MIDR 06.35.40 J;3; MOD: R 420ti.35;TS	AVX 13 x 1200 TM
				ALT	FROM: 09.95; MTR-CODE: MIDR06.35.40J;3; MOD: R420ti.35/TS	6 PK 1755 TM
				ALT	UNTIL: 08.95; MTR-CODE: MIDR06.35.40J;3; MOD: R420ti.35/TS	5 PK 1540 TM
				FAN	MTR-CODE: MIDR 06.35.40 J/3; MOD: Major;R 420ti.35/TS	9 PK 1200 TM

### Manager

#### 270.13

9839 ccm	195 kW	MIDR 06.20.45 B3	03.93 - 10.96	AC-C	MOD: G 270.13 SP	AVX 13 x 1350 TM
				ALT	MOD: G 270.13 SP	AVX 13 x 1375 TM

#### 270.14

9839 ccm	195 kW	MIDR 06.20.45 B3	03.93 - 10.96	AC-C	MOD: G 270.14 SP	AVX 13 x 1350 TM
				ALT	MOD: G 270.14 SP	AVX 13 x 1375 TM

#### 270.18; 270.17

9839 ccm	195 kW	MIDR 06.20.45 B3	11.92 - 10.96	AC-C	MOD: G 270.18;G 270.17	AVX 13 x 1250 TM
				ALT	MOD: G 270.18;G 270.17; - ENG-PTO	AVX 13 x 1375 TM
				ALT	MOD: G 270.18;G 270.17; + ENG-PTO	AVX 13 x 950 TM



## RENAULT TRUCKS

### Manager

<b>300.17</b>							
9839 ccm	222 kW	MIDR 06.20.45 D;MIDR 06.20.45 D3	09.91 - 10.96	AC-C	UNTIL: 06.95; MTR-CODE: MIDR 06.20.45 D; MOD: G 300.17;G 300.17;T	AVX 13 x 1250 TM	
				ALT	MTR-CODE: MIDR 06.20.45 D; MOD: G 300.17;G 300.17;T; - ENG-PTO	AVX 13 x 1375 TM	
				ALT	MTR-CODE: MIDR 06.20.45 D; MOD: G 300.17;G 300.17;T; + ENG-PTO	AVX 13 x 950 TM	
<b>300.17/T</b>							
9839 ccm	222 kW	MIDR 06.20.45 D;MIDR 06.20.45 D3	09.92 - 10.96	AC-C	UNTIL: 06.95; MTR-CODE: MIDR 06.20.45 D; MOD: G 300.17;G 300.17;T	AVX 13 x 1250 TM	
				ALT	MTR-CODE: MIDR 06.20.45 D; MOD: G 300.17;G 300.17;T; - ENG-PTO	AVX 13 x 1375 TM	
				ALT	MTR-CODE: MIDR 06.20.45 D; MOD: G 300.17;G 300.17;T; + ENG-PTO	AVX 13 x 950 TM	
<b>300.18</b>							
9839 ccm	222 kW	MIDR 06.20.45 D;MIDR 06.20.45 D3	09.92 - 10.96	AC-C	UNTIL: 06.95; MTR-CODE: MIDR 06.20.45 D; MOD: G 300.18	AVX 13 x 1250 TM	
				ALT	MTR-CODE: MIDR 06.20.45 D; MOD: G 300.18; - ENG-PTO	AVX 13 x 1375 TM	
				ALT	MTR-CODE: MIDR 06.20.45 D; MOD: G 300.18; + ENG-PTO	AVX 13 x 950 TM	
<b>300.24</b>							
9839 ccm	222 kW	MIDR 06.20.45 D;MIDR 06.20.45 D3	09.91 - 10.96	AC-C	UNTIL: 06.95; MTR-CODE: MIDR 06.20.45 D; MOD: G 300.24	AVX 13 x 1250 TM	
				ALT	MTR-CODE: MIDR 06.20.45 D; MOD: G 300.24; - ENG-PTO	AVX 13 x 1375 TM	
				ALT	MTR-CODE: MIDR 06.20.45 D; MOD: G 300.24; + ENG-PTO	AVX 13 x 950 TM	
<b>300.25</b>							
9839 ccm	222 kW	MIDR 06.20.45 D;MIDR 06.20.45 D3	09.91 - 10.96	AC-C	UNTIL: 06.95; MTR-CODE: MIDR 06.20.45 D; MOD: G 300.25	AVX 13 x 1250 TM	
				ALT	MTR-CODE: MIDR 06.20.45 D; MOD: G 300.25; - ENG-PTO	AVX 13 x 1375 TM	
				ALT	MTR-CODE: MIDR 06.20.45 D; MOD: G 300.25; + ENG-PTO	AVX 13 x 950 TM	
<b>300.26</b>							
9839 ccm	222 kW	MIDR 06.20.45 D;MIDR 06.20.45 D3	09.91 - 10.96	AC-C	UNTIL: 06.95; MTR-CODE: MIDR 06.20.45 D; MOD: G 300.26	AVX 13 x 1250 TM	
				ALT	MTR-CODE: MIDR 06.20.45 D; MOD: G 300.26; - ENG-PTO	AVX 13 x 1375 TM	
				ALT	MTR-CODE: MIDR 06.20.45 D; MOD: G 300.26; + ENG-PTO	AVX 13 x 950 TM	
<b>300.26/T</b>							
9839 ccm	222 kW	MIDR 06.20.45 D;MIDR 06.20.45 D3	09.91 - 10.96	AC-C	UNTIL: 06.95; MTR-CODE: MIDR 06.20.45 D; MOD: G 300.26	AVX 13 x 1250 TM	
				ALT	MTR-CODE: MIDR 06.20.45 D; MOD: G 300.26; - ENG-PTO	AVX 13 x 1375 TM	
				ALT	MTR-CODE: MIDR 06.20.45 D; MOD: G 300.26; + ENG-PTO	AVX 13 x 950 TM	

### Maxter

<b>270.19</b>							
9839 ccm	195 kW	MIDR 06.20.45 B3	01.93 - 10.96	AC-C	MOD: G 270.19	AVX 13 x 1250 TM	
				ALT	MOD: G 270.19; - ENG-PTO	AVX 13 x 1375 TM	
				ALT	MOD: G 270.19; + ENG-PTO	AVX 13 x 950 TM	
<b>300.18</b>							
9839 ccm	222 kW	MIDR 06.20.45 D;MIDR 06.20.45 D3	10.92 - 10.96	AC-C	MTR-CODE: MIDR 06.20.45 D; MOD: G 300.18	AVX 13 x 1250 TM	
				AC-C	MTR-CODE: MIDR 06.20.45 D; MOD: G 300.18	AVX 13 x 1350 TM	
				AC-C	MTR-CODE: MIDR 06.20.45 D; MOD: G 340Ti	AVX 13 x 1250 TM	
				AC-C	MTR-CODE: MIDR 06.20.45 D; MOD: G 340Ti	AVX 13 x 1350 TM	
				ALT	MTR-CODE: MIDR 06.20.45 D; MOD: G 300.18; - ENG-PTO	AVX 13 x 1375 TM	
				ALT	MTR-CODE: MIDR 06.20.45 D; MOD: G 340Ti; - ENG-PTO	AVX 13 x 1375 TM	
<b>300.26</b>							
9839 ccm	222 kW	MIDR 06.20.45 D3	10.92 - 06.97	AC-C	MOD: G 300.26	AVX 13 x 1250 TM	
				AC-C	MOD: G 300.26	AVX 13 x 1350 TM	
				ALT	MOD: G 300.26; - ENG-PTO	AVX 13 x 1375 TM	

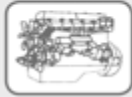

## RENAULT TRUCKS

### Midliner

<b>100.06/A</b>						
3869 ccm	69-72 kW	T 4.38	01.86 - 09.90	ALT	MOD: S 100.06;A; REQ: 2	AVX 13 x 1350 TM
<b>100.07/A</b>						
3869 ccm	69-72 kW	T 4.38	01.86 - 09.90	ALT	MOD: S 100.07;A; REQ: 2	AVX 13 x 1350 TM
<b>100.08/A</b>						
3869 ccm	69-72 kW	T 4.38	01.86 - 09.90	ALT	MOD: S 100.08;A; REQ: 2	AVX 13 x 1350 TM
<b>100.09/A</b>						
3869 ccm	69-72 kW	T 4.38	01.86 - 09.90	ALT	MOD: S 100.09;A BOM; REQ: 2	AVX 13 x 1350 TM
<b>110.06/A</b>						
5453 ccm	76 kW	797-21	06.85 - 09.90	AIR-C	MOD: S 110.06;A; REQ: 2	AVX 13 x 925 TM
<b>110.07/A</b>						
5453 ccm	76 kW	797-21	06.85 - 09.90	AIR-C	MOD: S 110.07;A; REQ: 2	AVX 13 x 925 TM
<b>110.08/A</b>						
5453 ccm	76 kW	797-21	06.85 - 09.90	AIR-C	MOD: S 110.08;A; REQ: 2	AVX 13 x 925 TM
<b>120.06/A</b>						
3869 ccm	82 kW	T 4.40	09.90 - 11.92	ALT	MOD: S 120.06;A; REQ: 2; GB	AVX 13 x 1225 TM
<b>120.07/A</b>						
3869 ccm	82 kW	T 4.40	09.90 - 10.94	ALT	MOD: S 120.07;A; REQ: 2; GB	AVX 13 x 1225 TM
<b>120.08/A</b>						
3869 ccm	82 kW	T 4.40	09.90 - 10.94	ALT	MOD: S 120.08;A; REQ: 2; GB	AVX 13 x 1225 TM
<b>120.09/B</b>						
3869 ccm	82 kW	T 4.40	09.90 - 10.94	ALT	MOD: S 120.09;B BOM; REQ: 2; GB	AVX 13 x 1225 TM
<b>130.06</b>						
5453 ccm	96-97 kW	797	09.83 - 01.90	AIR-C	MOD: S 130.06; REQ: 2	AVX 13 x 925 TM
<b>130.07</b>						
5453 ccm	96-97 kW	797	09.83 - 01.90	AIR-C	MOD: S 130.07; REQ: 2	AVX 13 x 925 TM
<b>130.08/A; 130.08/B</b>						
5453 ccm	96-97 kW	797	09.83 - 01.90	AIR-C	MOD: S 130.08;A;S 130.08; REQ: 2	AVX 13 x 925 TM
<b>130.08/R</b>						
5453 ccm	96-97 kW	797	09.83 - 01.90	AIR-C	MOD: S 130.08;A;S 130.08; REQ: 2	AVX 13 x 925 TM
<b>130.09/B</b>						
5453 ccm	96-97 kW	797	09.83 - 01.90	AIR-C	MOD: S 130.09;B; REQ: 2	AVX 13 x 925 TM
<b>130.11</b>						
5453 ccm	96-97 kW	797	09.83 - 01.90	AIR-C	MOD: S 130.11;S 130.11;B; REQ: 2	AVX 13 x 925 TM
<b>130.11/B</b>						
5453 ccm	96-97 kW	797	09.83 - 01.90	AIR-C	MOD: S 130.11;S 130.11;B; REQ: 2	AVX 13 x 925 TM
<b>130.13/B</b>						
5453 ccm	96-97 kW	797	09.83 - 01.90	AIR-C	MOD: S 130.13;B; REQ: 2	AVX 13 x 925 TM
<b>140.12/C</b>						
5490 ccm	103 kW	MIDS 06.02.12 C	05.89 - 03.93	AC-C	MOD: M 140.12;C	AVX 13 x 1200 TM
<b>140.13/C</b>						
5490 ccm	103 kW	MIDS 06.02.12 C	04.89 - 03.93	AC-C	MOD: M 140.13;C	AVX 13 x 1200 TM
<b>160.12/C</b>						
5490 ccm	117 kW	MIDS 06.02.12 B	05.89 - 03.93	AC-C	MOD: M 160.12;C	AVX 13 x 1200 TM
<b>160.13/C</b>						
5490 ccm	117 kW	MIDS 06.02.12 B	05.89 - 03.93	AC-C	MOD: M 160.13;C	AVX 13 x 1200 TM
<b>160.14/C</b>						
5490 ccm	117 kW	MIDS 06.02.12 B	05.89 - 03.93	AC-C	MOD: M 160.14;C BOM	AVX 13 x 1200 TM
<b>160.15/D</b>						
5490 ccm	117 kW	MIDS 06.02.12 B	05.89 - 03.93	AC-C	MOD: M 160.15;D	AVX 13 x 1200 TM
<b>170.11TI</b>						
5490 ccm	127-135 kW	MIDR 06.02.12 D	10.87 - 05.89	AIR-C	MOD: S 170.11TI; REQ: 2	AVX 13 x 925 TM
<b>170.11TI/R</b>						
5490 ccm	127-135 kW	MIDR 06.02.12 D	10.87 - 05.89	AIR-C	MOD: S 170.11TI; REQ: 2	AVX 13 x 925 TM
<b>170.13TI</b>						
5490 ccm	127-135 kW	MIDR 06.02.12 D	10.83 - 03.93	AIR-C	MOD: S 170.13TI; REQ: 2	AVX 13 x 925 TM
<b>170.13TI/T</b>						
5490 ccm	127-135 kW	MIDR 06.02.12 D	10.84 - 05.89	AIR-C	MOD: S 170.13TI; REQ: 2	AVX 13 x 925 TM
<b>170.13TI; 170</b>						
5490 ccm	127-135 kW	MIDR 06.02.12 D	10.83 - 03.93	AIR-C	MOD: S 170.13TI; REQ: 2	AVX 13 x 925 TM
<b>170.13TI; 170.13TI/R</b>						
5490 ccm	127-135 kW	MIDR 06.02.12 D	10.83 - 05.89	AIR-C	MOD: S 170.13TI; REQ: 2	AVX 13 x 925 TM

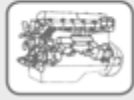

## RENAULT TRUCKS

### Midliner

<b>170.14TI</b>	5490 ccm	127-135 kW	MIDR 06.02.12 D	10.83 - 05.89	AIR-C	MOD: S 170.14TI; REQ: 2	<b>AVX 13 x 925 TM</b>
<b>170.14TI/R</b>	5490 ccm	127-135 kW	MIDR 06.02.12 D	10.87 - 05.89	AIR-C	MOD: S 170.14TI; REQ: 2	<b>AVX 13 x 925 TM</b>
<b>170.15TI</b>	5490 ccm	127-135 kW	MIDR 06.02.12 D	10.82 - 09.93	AIR-C	UNTIL: 10.89; MOD: S 170.15TI; REQ: 2	<b>AVX 13 x 925 TM</b>
<b>200.10/C</b>	6178 ccm	144 kW	MIDR 06.02.26 H	05.88 - 03.93	AC-C	MOD: M 200.10;C	<b>AVX 13 x 1200 TM</b>
<b>200.12/C</b>	6178 ccm	144 kW	MIDR 06.02.26 H	05.88 - 03.93	AC-C	MOD: M 200.12;C	<b>AVX 13 x 1200 TM</b>
<b>200.13/C</b>	6178 ccm	144 kW	MIDR 06.02.26 H	05.88 - 03.93	AC-C	MOD: M 200.13;C	<b>AVX 13 x 1200 TM</b>
<b>200.14/C</b>	6178 ccm	144 kW	MIDR 06.02.26 H	05.88 - 03.93	AC-C	MOD: M 200.14;C BOM	<b>AVX 13 x 1200 TM</b>
<b>200.15/D</b>	6178 ccm	144 kW	MIDR 06.02.26 H	05.88 - 03.93	AC-C	MOD: M 200.15;D	<b>AVX 13 x 1200 TM</b>
<b>200.16/D</b>	6178 ccm	144 kW	MIDR 06.02.26 H	05.88 - 03.93	AC-C	MOD: M 200.16;D	<b>AVX 13 x 1200 TM</b>
<b>210.13/C</b>	6180 ccm	151-154 kW	MIDR 06.02.26 W;MIDR 06.02.26 W/41	05.92 - 01.00	AC-C	MTR-CODE: MIDR060212;MIDR060226; REQ: 2	<b>AVX 10 x 1250</b>
					ALT	MTR-CODE: MIDR060226U;MIDR060226V;MIDR060226W;MIDR060226X; REQ: 2	<b>AVX 10 x 1275</b>
<b>230.10/C</b>	6180 ccm	166 kW	MIDR 06.02.26 D;MIDR 06.02.26 S	05.89 - 07.92	AC-C	MTR-CODE: MIDR 06.02.26 D; MOD: M 230.10;C	<b>AVX 13 x 1200 TM</b>
<b>230.12/D</b>	6180 ccm	166 kW	MIDR 06.02.26 D;MIDR 06.02.26 S	05.89 - 07.92	AC-C	MTR-CODE: MIDR 06.02.26 D; MOD: M 230.12;D	<b>AVX 13 x 1200 TM</b>
<b>230.13/D</b>	6180 ccm	166 kW	MIDR 06.02.26 D;MIDR 06.02.26 S	05.89 - 07.92	AC-C	MTR-CODE: MIDR 06.02.26 D; MOD: M 230.13;D	<b>AVX 13 x 1200 TM</b>
<b>230.13C/T</b>	6180 ccm	166 kW	MIDR 06.02.26 D;MIDR 06.02.26 S;MIDR 06.02.26 X	05.89 - 10.96	ALT	LHD	<b>AVX 10 x 1275</b>
					ALT	RHD	<b>AVX 10 x 1250</b>
<b>230.16D/T</b>	6180 ccm	166 kW	MIDR 06.02.26 D;MIDR 06.02.26 S;MIDR 06.02.26 X	05.89 - 10.96	ALT	LHD	<b>AVX 10 x 1275</b>
					ALT	RHD	<b>AVX 10 x 1250</b>
<b>250.13/C</b>	6180 ccm	184 kW	MIDR 06.02.26 Y/41	05.96 - 01.00	ALT	REQ: 2	<b>AVX 10 x 1275</b>

### Midlum

<b>210.08/B</b>	6177 ccm	154 kW	MIDR 06.02.26 W/4	01.00 -	FAN	MTR-CODE: MIDR 06.02.26 W;4; OE-NO.: 5000686548; MOD: 210.08;B	<b>AVX 13 x 1200 TM</b>
					FAN	MTR-CODE: MIDR 06.02.26 W;4; OE-NO.: 5001014473; MOD: 210.08;B	<b>AVX 13 x 1175 TM</b>
<b>210.08/B; 220.08/B</b>	6177 ccm	154-158 kW	dci 6W;MIDR 06.02.26 W/4	01.00 -	FAN	MTR-CODE: MIDR 06.02.26 W;4; OE-NO.: 5000686548; MOD: 210.08;B	<b>AVX 13 x 1200 TM</b>
					FAN	MTR-CODE: MIDR 06.02.26 W;4; OE-NO.: 5001014473; MOD: 210.08;B	<b>AVX 13 x 1175 TM</b>
<b>210.09/B</b>	6177 ccm	154 kW	MIDR 06.02.26 W/4	01.00 -	FAN	MTR-CODE: MIDR 06.02.26 W;4; OE-NO.: 5000686548; MOD: 210.09;B	<b>AVX 13 x 1200 TM</b>
					FAN	MTR-CODE: MIDR 06.02.26 W;4; OE-NO.: 5001014473; MOD: 210.09;B	<b>AVX 13 x 1175 TM</b>
<b>210.10/B</b>	6177 ccm	154 kW	MIDR 06.02.26 W/4	01.00 -	FAN	MTR-CODE: MIDR 06.02.26 W;4; OE-NO.: 5000686548; MOD: 210.10;B	<b>AVX 13 x 1200 TM</b>
					FAN	MTR-CODE: MIDR 06.02.26 W;4; OE-NO.: 5001014473; MOD: 210.10;B	<b>AVX 13 x 1175 TM</b>
<b>210.10/B; 220.10/B</b>	6177 ccm	154-158 kW	dci 6W;MIDR 06.02.26 W/4	01.00 -	FAN	MTR-CODE: MIDR 06.02.26 W;4; OE-NO.: 5000686548; MOD: 210.10;B	<b>AVX 13 x 1200 TM</b>



## RENAULT TRUCKS

### Midlum

#### 210.10/B; 220.10/B

6177 ccm	154-158 kW	dci 6W;MIDR 06.02.26 W/4	01.00 -	FAN	MTR-CODE: MIDR 06.02.26 W;4; OE-NO.: 5001014473; MOD: 210.10;B	<b>AVX 13 x 1175 TM</b>
----------	------------	--------------------------	---------	-----	--	-------------------------

#### 210.12/C

6177 ccm	154 kW	MIDR 06.02.26 W/4	01.00 -	FAN	MTR-CODE: MIDR 06.02.26 W;4; OE-NO.: 5000686548; MOD: 210.12;C	<b>AVX 13 x 1200 TM</b>
				FAN	MTR-CODE: MIDR 06.02.26 W;4; OE-NO.: 5001014473; MOD: 210.12;C	<b>AVX 13 x 1175 TM</b>

#### 210.12/C; 220.12/C

6177 ccm	154-158 kW	dci 6W;MIDR 06.02.26 W/4	01.00 -	FAN	MTR-CODE: MIDR 06.02.26 W;4; OE-NO.: 5000686548; MOD: 210.12;C	<b>AVX 13 x 1200 TM</b>
				FAN	MTR-CODE: MIDR 06.02.26 W;4; OE-NO.: 5001014473; MOD: 210.12;C	<b>AVX 13 x 1175 TM</b>

#### 210.13/C

6177 ccm	154 kW	MIDR 06.02.26 W/4	01.00 -	FAN	MTR-CODE: MIDR 06.02.26 W;4; OE-NO.: 5000686548; MOD: 210.13;C	<b>AVX 13 x 1200 TM</b>
				FAN	MTR-CODE: MIDR 06.02.26 W;4; OE-NO.: 5001014473; MOD: 210.13;C	<b>AVX 13 x 1175 TM</b>

#### 210.13/C; 220.13/C; 220.13/D

6177 ccm	154-158 kW	dci 6W;MIDR 06.02.26 W/4	01.00 -	FAN	MTR-CODE: MIDR 06.02.26 W;4; OE-NO.: 5000686548; MOD: 210.13;C	<b>AVX 13 x 1200 TM</b>
				FAN	MTR-CODE: MIDR 06.02.26 W;4; OE-NO.: 5001014473; MOD: 210.13;C	<b>AVX 13 x 1175 TM</b>

#### 210.14/C; 220.14/C; 220.14/D

6177 ccm	154-158 kW	dci 6W;MIDR 06.02.26 W/4	01.00 -	FAN	MTR-CODE: dci 6W; OE-NO.: 5000686548; MOD: 210.14;C	<b>AVX 13 x 1200 TM</b>
				FAN	MTR-CODE: dci 6W; OE-NO.: 5001014473; MOD: 210.14;C	<b>AVX 13 x 1175 TM</b>

#### 210.15/C

6177 ccm	154 kW	MIDR 06.02.26 W/4	01.00 -	FAN	MTR-CODE: MIDR 06.02.26 W;4; OE-NO.: 5000686548; MOD: 210.15;C	<b>AVX 13 x 1200 TM</b>
				FAN	MTR-CODE: MIDR 06.02.26 W;4; OE-NO.: 5001014473; MOD: 210.15;C	<b>AVX 13 x 1175 TM</b>

#### 210.16/C; 220.16/C; 22.16/D

6177 ccm	154-158 kW	dci 6W;MIDR 06.02.26 W/4	01.00 -	FAN	MTR-CODE: dci 6W; OE-NO.: 5000686548; MOD: 210.16;C	<b>AVX 13 x 1200 TM</b>
				FAN	MTR-CODE: dci 6W; OE-NO.: 5001014473; MOD: 210.16;C	<b>AVX 13 x 1175 TM</b>

#### 250.12/C

6177 ccm	184 kW	MIDR 06.02.26 Y/41	01.00 -	FAN	MTR-CODE: MIDR 06.02.26 Y;41; OE-NO.: 5000686548; MOD: 250.12;C	<b>AVX 13 x 1200 TM</b>
				FAN	MTR-CODE: MIDR 06.02.26 Y;41; OE-NO.: 5001014473; MOD: 250.12;C	<b>AVX 13 x 1175 TM</b>

#### 250.13/C

6177 ccm	184 kW	MIDR 06.02.26 Y/41	01.00 -	FAN	MTR-CODE: MIDR 06.02.26 Y;41; OE-NO.: 5000686548; MOD: 250.13;C	<b>AVX 13 x 1200 TM</b>
				FAN	MTR-CODE: MIDR 06.02.26 Y;41; OE-NO.: 5001014473; MOD: 250.13;C	<b>AVX 13 x 1175 TM</b>

#### 250.14/C

6177 ccm	184 kW	MIDR 06.02.26 Y/41	01.00 -	FAN	MTR-CODE: MIDR 06.02.26 Y;41; OE-NO.: 5000686548; MOD: 250.14;C	<b>AVX 13 x 1200 TM</b>
				FAN	MTR-CODE: MIDR 06.02.26 Y;41; OE-NO.: 5001014473; MOD: 250.14;C	<b>AVX 13 x 1175 TM</b>

#### 250.15/C

6177 ccm	184 kW	MIDR 06.02.26 Y/41	01.00 -	FAN	MTR-CODE: MIDR 06.02.26 Y;41; OE-NO.: 5000686548; MOD: 250.15;C	<b>AVX 13 x 1200 TM</b>
				FAN	MTR-CODE: MIDR 06.02.26 Y;41; OE-NO.: 5001014473; MOD: 250.15;C	<b>AVX 13 x 1175 TM</b>

#### 250.16/C

6177 ccm	184 kW	MIDR 06.02.26 Y/41	01.00 -	FAN	MTR-CODE: MIDR 06.02.26 Y;41; OE-NO.: 5000686548; MOD: 250.16;C;250.16;CT	<b>AVX 13 x 1200 TM</b>
				FAN	MTR-CODE: MIDR 06.02.26 Y;41; OE-NO.: 5001014473; MOD: 250.16;C;250.16;CT	<b>AVX 13 x 1175 TM</b>

#### 250.16/CT

6177 ccm	184 kW	MIDR 06.02.26 Y/41	01.00 -	FAN	MTR-CODE: MIDR 06.02.26 Y;41; OE-NO.: 5000686548; MOD: 250.16;C;250.16;CT	<b>AVX 13 x 1200 TM</b>
				FAN	MTR-CODE: MIDR 06.02.26 Y;41; OE-NO.: 5001014473; MOD: 250.16;C;250.16;CT	<b>AVX 13 x 1175 TM</b>

### Premium

#### 210.16

6177 ccm	154 kW	MIDR 06.02.26 W/4	04.96 -	AC-C	MTR-CODE: MIDR 06.02.26 W;4; MOD: 210.16	<b>AVX 13 x 1200 TM</b>
----------	--------	-------------------	---------	------	--	-------------------------



## RENAULT TRUCKS

### Premium

<b>210.16</b>						
6177 ccm	154 kW	MIDR 06.02.26 W/4	04.96 -	ALT	REQ: 2; LHD	AVX 10 x 1275
				ALT	REQ: 2; RHD	AVX 10 x 1250
<b>210.18D; 220.18</b>						
6177 ccm	154-158 kW	dci 6W;MIDR 06.02.26 W/4	04.96 -	AC-C	MTR-CODE: dci 6W; MOD: 210.18D	AVX 13 x 1200 TM
				ALT	REQ: 2; LHD	AVX 10 x 1275
				ALT	REQ: 2; RHD	AVX 10 x 1250
<b>250.16</b>						
6177 ccm	184 kW	MIDR 06.02.26 Y/41	04.96 -	AC-C	MTR-CODE: MIDR 06.02.26 Y;41; MOD: 250.16	AVX 13 x 1200 TM
				ALT	REQ: 2; LHD	AVX 10 x 1275
				ALT	REQ: 2; RHD	AVX 10 x 1250
<b>250.18D</b>						
6180 ccm	184 kW	MIDR 06.02.26 Y/41	04.96 -	AC-C	MTR-CODE: MIDR 06.02.26 Y;41; MOD:	AVX 13 x 1200 TM
				ALT	250.18D	AVX 10 x 1275
				ALT	REQ: 2; RHD	AVX 10 x 1250
<b>250.19</b>						
6177 ccm	184 kW	MIDR 06.02.26 Y/41	04.96 -	AC-C	MTR-CODE: MIDR 06.02.26 Y;41; MOD: 250.19	AVX 13 x 1200 TM
				ALT	REQ: 2; LHD	AVX 10 x 1275
				ALT	REQ: 2; RHD	AVX 10 x 1250
<b>260.16</b>						
9839 ccm	188 kW	MIDR 06.20.45 C/4	04.96 -	AC-C	MTR-CODE: MIDR 06.20.45 C;4; MOD: 260.16	AVX 13 x 1225 TM
				AC-C	UNTIL: 03.97; MTR-CODE: MIDR 06.20.45 C;4;	AVX 13 x 1375 TM
				ALT	AMP: 60; MOD: 260.16	6 PK 1425 TM
				ALT	FROM: 04.97; UNTIL: 04.01; MTR-CODE:	6 PK 1395 TM
				ALT	MIDR06.20.45C;4; OE-NO.: 5010359916; MOD:	
				ALT	260.16	
				ALT	FROM: 04.97; UNTIL: 04.01; MTR-CODE:	6 PK 1395 TM
				ALT	MIDR06.20.45C;4; OE-NO.: 5010477766; MOD:	
				ALT	260.16	
<b>260.18</b>						
9839 ccm	188 kW	MIDR 06.20.45 C/4	04.96 -	AC-C	MTR-CODE: MIDR 06.20.45 C;4; MOD: 260.18	AVX 13 x 1225 TM
				AC-C	UNTIL: 03.97; MTR-CODE: MIDR 06.20.45 C;4;	AVX 13 x 1375 TM
				ALT	AMP: 60; MOD: 260.18	6 PK 1425 TM
				ALT	FROM: 04.97; UNTIL: 04.01; MTR-CODE:	6 PK 1395 TM
				ALT	MIDR06.20.45C;4; OE-NO.: 5010359916; MOD:	
				ALT	260.18	
				ALT	FROM: 04.97; UNTIL: 04.01; MTR-CODE:	6 PK 1395 TM
				ALT	MIDR06.20.45C;4; OE-NO.: 5010477766; MOD:	
				ALT	260.18	
<b>260.19</b>						
9839 ccm	188 kW	MIDR 06.20.45 C/4	04.96 -	AC-C	MTR-CODE: MIDR 06.20.45 C;4; MOD: 260.19	AVX 13 x 1225 TM
				AC-C	UNTIL: 03.97; MTR-CODE: MIDR 06.20.45 C;4;	AVX 13 x 1375 TM
				ALT	AMP: 60; MOD: 260.19	6 PK 1425 TM
				ALT	FROM: 04.97; UNTIL: 04.01; MTR-CODE:	6 PK 1395 TM
				ALT	MIDR06.20.45C;4; OE-NO.: 5010359916; MOD:	
				ALT	260.19	
				ALT	FROM: 04.97; UNTIL: 04.01; MTR-CODE:	6 PK 1395 TM
				ALT	MIDR06.20.45C;4; OE-NO.: 5010477766; MOD:	
				ALT	260.19	
<b>300.16</b>						
9839 ccm	219 kW	MIDR 06.20.45 D/41	09.96 -	AC-C	MTR-CODE: MIDR 06.20.45 D;41; MOD: 300.16	AVX 13 x 1225 TM
				AC-C	UNTIL: 03.97; MTR-CODE: MIDR 06.20.45 D;41;	AVX 13 x 1375 TM
				ALT	AMP: 60; MOD: 300.16	6 PK 1425 TM
				ALT	FROM: 04.97; UNTIL: 04.01; MTR-CODE:	6 PK 1395 TM
				ALT	MIDR06.20.45D;41; OE-NO.: 5010359916;	
				ALT	MOD: 300.16	
				ALT	FROM: 04.97; UNTIL: 04.01; MTR-CODE:	6 PK 1395 TM
				ALT	MIDR06.20.45D;41; OE-NO.: 5010477766;	
				ALT	MOD: 300.16	
<b>300.16T</b>						
9839 ccm	219 kW	MIDR 06.20.45 D/41	04.96 -	AC-C	MTR-CODE: MIDR 06.20.45 D;41; MOD: 300.16T	AVX 13 x 1225 TM
				AC-C	UNTIL: 03.97; MTR-CODE: MIDR 06.20.45 D;41;	AVX 13 x 1375 TM
				ALT	AMP: 60; MOD: 300.16T	6 PK 1425 TM
				ALT	FROM: 04.97; UNTIL: 04.01; MTR-CODE:	6 PK 1395 TM
				ALT	MIDR06.20.45D;41; OE-NO.: 5010359916;	
				ALT	MOD: 300.16T	
				ALT	FROM: 04.97; UNTIL: 04.01; MTR-CODE:	6 PK 1395 TM
				ALT	MIDR06.20.45D;41; OE-NO.: 5010477766;	
				ALT	MOD: 300.16T	



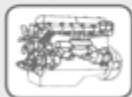

## RENAULT TRUCKS

### Premium

#### 300.18

9839 ccm	219 kW	MIDR 06.20.45 D/41	09.96 -	AC-C	MTR-CODE: MIDR 06.20.45 D;41; MOD: 300.18;300.18T	AVX 13 x 1225 TM
				AC-C	UNTIL: 03.97; MTR-CODE: MIDR 06.20.45 D;41; AMP: 60; MOD: 300.18;300.18T	AVX 13 x 1375 TM
				ALT	FROM: 04.97; UNTIL: 04.01; MTR-CODE: MIDR06.20.45D;41; OE-NO.: 5010359916; MOD: 300.18;300.18T	6 PK 1425 TM
				ALT	FROM: 04.97; UNTIL: 04.01; MTR-CODE: MIDR06.20.45D;41; OE-NO.: 5010477766; MOD: 300.18;300.18T	6 PK 1395 TM

#### 300.18D

9839 ccm	219 kW	MIDR 06.20.45 D/41	04.96 -	AC-C	MTR-CODE: MIDR 06.20.45 D;41; MOD: 300.18D;300.18D;T	AVX 13 x 1225 TM
				AC-C	UNTIL: 03.97; MTR-CODE: MIDR 06.20.45 D;41; AMP: 60; MOD: 300.18D;300.18D;T	AVX 13 x 1375 TM
				ALT	FROM: 04.97; UNTIL: 04.01; MTR-CODE: MIDR06.20.45D;41; OE-NO.: 5010359916; MOD: 300.18D;300.18D;T	6 PK 1425 TM
				ALT	FROM: 04.97; UNTIL: 04.01; MTR-CODE: MIDR06.20.45D;41; OE-NO.: 5010477766; MOD: 300.18D;300.18D;T	6 PK 1395 TM

#### 300.18D/T

9839 ccm	219 kW	MIDR 06.20.45 D/41	04.96 -	AC-C	MTR-CODE: MIDR 06.20.45 D;41; MOD: 300.18D;300.18D;T	AVX 13 x 1225 TM
				AC-C	UNTIL: 03.97; MTR-CODE: MIDR 06.20.45 D;41; AMP: 60; MOD: 300.18D;300.18D;T	AVX 13 x 1375 TM
				ALT	FROM: 04.97; UNTIL: 04.01; MTR-CODE: MIDR06.20.45D;41; OE-NO.: 5010359916; MOD: 300.18D;300.18D;T	6 PK 1425 TM
				ALT	FROM: 04.97; UNTIL: 04.01; MTR-CODE: MIDR06.20.45D;41; OE-NO.: 5010477766; MOD: 300.18D;300.18D;T	6 PK 1395 TM

#### 300.18T

9839 ccm	219 kW	MIDR 06.20.45 D/41	09.96 -	AC-C	MTR-CODE: MIDR 06.20.45 D;41; MOD: 300.18;300.18T	AVX 13 x 1225 TM
				AC-C	UNTIL: 03.97; MTR-CODE: MIDR 06.20.45 D;41; AMP: 60; MOD: 300.18;300.18T	AVX 13 x 1375 TM
				ALT	FROM: 04.97; UNTIL: 04.01; MTR-CODE: MIDR06.20.45D;41; OE-NO.: 5010359916; MOD: 300.18;300.18T	6 PK 1425 TM
				ALT	FROM: 04.97; UNTIL: 04.01; MTR-CODE: MIDR06.20.45D;41; OE-NO.: 5010477766; MOD: 300.18;300.18T	6 PK 1395 TM

#### 300.19

9839 ccm	219 kW	MIDR 06.20.45 D/41	04.96 -	AC-C	MTR-CODE: MIDR 06.20.45 D;41; MOD: 300.19;300.19T	AVX 13 x 1225 TM
				AC-C	UNTIL: 03.97; MTR-CODE: MIDR 06.20.45 D;41; AMP: 60; MOD: 300.19;300.19T	AVX 13 x 1375 TM
				ALT	FROM: 04.97; UNTIL: 04.01; MTR-CODE: MIDR06.20.45D;41; OE-NO.: 5010359916; MOD: 300.19;300.19T	6 PK 1425 TM
				ALT	FROM: 04.97; UNTIL: 04.01; MTR-CODE: MIDR06.20.45D;41; OE-NO.: 5010477766; MOD: 300.19;300.19T	6 PK 1395 TM

#### 300.19D/T

9839 ccm	219 kW	MIDR 06.20.45 D/41	04.96 -	AC-C	MTR-CODE: MIDR 06.20.45 D;41; MOD: 300.19D;T	AVX 13 x 1225 TM
				AC-C	UNTIL: 03.97; MTR-CODE: MIDR 06.20.45 D;41; AMP: 60; MOD: 300.19D;T	AVX 13 x 1375 TM
				ALT	FROM: 04.97; UNTIL: 04.01; MTR-CODE: MIDR06.20.45D;41; OE-NO.: 5010359916; MOD: 300.19D;T	6 PK 1425 TM
				ALT	FROM: 04.97; UNTIL: 04.01; MTR-CODE: MIDR06.20.45D;41; OE-NO.: 5010477766; MOD: 300.19D;T	6 PK 1395 TM

#### 300.19T

9839 ccm	219 kW	MIDR 06.20.45 D/41	09.96 -	AC-C	MTR-CODE: MIDR 06.20.45 D;41; MOD: 300.19;300.19T	AVX 13 x 1225 TM
				AC-C	UNTIL: 03.97; MTR-CODE: MIDR 06.20.45 D;41; AMP: 60; MOD: 300.19;300.19T	AVX 13 x 1375 TM
				ALT	FROM: 04.97; UNTIL: 04.01; MTR-CODE: MIDR06.20.45D;41; OE-NO.: 5010359916; MOD: 300.19;300.19T	6 PK 1425 TM

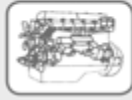

## RENAULT TRUCKS

### Premium

<b>300.19T</b>							
9839 ccm	219 kW	MIDR 06.20.45 D/41	09.96 -	ALT	FROM: 04.97; UNTIL: 04.01; MTR-CODE: MIDR06.20.45D;41; OE-NO.: 5010477766; MOD: 300.19;300.19T		<b>6 PK 1395 TM</b>
<b>300.26D</b>							
9839 ccm	219 kW	MIDR 06.20.45 D/41	04.96 -	AC-C	MTR-CODE: MIDR 06.20.45 D;41; MOD: 300.26D		<b>AVX 13 x 1225 TM</b>
				AC-C	UNTIL: 03.97; MTR-CODE: MIDR 06.20.45 D;41; AMP: 60; MOD: 300.26D		<b>AVX 13 x 1375 TM</b>
				ALT	FROM: 04.97; UNTIL: 04.01; MTR-CODE: MIDR06.20.45D;41; OE-NO.: 5010359916; MOD: 300.26D		<b>6 PK 1425 TM</b>
				ALT	FROM: 04.97; UNTIL: 04.01; MTR-CODE: MIDR06.20.45D;41; OE-NO.: 5010477766; MOD: 300.26D		<b>6 PK 1395 TM</b>
<b>320.18</b>							
11100 ccm	230 kW	dCi 11G	08.00 -	ALT	MOD: 320.18		<b>5 PK 1025 TM</b>
				ALT	MOD: 320.18D		<b>5 PK 1025 TM</b>
<b>320.24D</b>							
11100 ccm	230 kW	dCi 11G	08.00 -	ALT	MOD: 320.26D		<b>5 PK 1025 TM</b>
<b>340.18D</b>							
9839 ccm	249 kW	MIDR 06.20.45 E/41	04.96 -	AC-C	MTR-CODE: MIDR 06.20.45 E;41; MOD: 340.18D;340.18D;T		<b>AVX 13 x 1225 TM</b>
				ALT	FROM: 02.97; MTR-CODE: MIDR06.20.45E;41; MOD: 340.18D;340.18D;T		<b>6 PK 1065 TM</b>
				ALT	UNTIL: 01.97; MTR-CODE: MIDR06.20.45E;41; AMP: 60; MOD: 340.18D;340.18D;T		<b>5 PK 1010 TM</b>
				ALT	UNTIL: 01.97; MTR-CODE: MIDR06.20.45E;41; AMP: 80; MOD: 340.18D;340.18D;T		<b>6 PK 1065 TM</b>
<b>340.18D/T</b>							
9839 ccm	249 kW	MIDR 06.20.45 E/41	04.96 -	AC-C	MTR-CODE: MIDR 06.20.45 E;41; MOD: 340.18D;340.18D;T		<b>AVX 13 x 1225 TM</b>
				ALT	FROM: 02.97; MTR-CODE: MIDR06.20.45E;41; MOD: 340.18D;340.18D;T		<b>6 PK 1065 TM</b>
				ALT	UNTIL: 01.97; MTR-CODE: MIDR06.20.45E;41; AMP: 60; MOD: 340.18D;340.18D;T		<b>5 PK 1010 TM</b>
				ALT	UNTIL: 01.97; MTR-CODE: MIDR06.20.45E;41; AMP: 80; MOD: 340.18D;340.18D;T		<b>6 PK 1065 TM</b>
<b>340.18T</b>							
9839 ccm	249 kW	MIDR 06.20.45 E/41	04.96 -	AC-C	MTR-CODE: MIDR 06.20.45 E;41; MOD: 340.18T		<b>AVX 13 x 1225 TM</b>
				ALT	FROM: 02.97; MTR-CODE: MIDR06.20.45E;41; MOD: 340.18T		<b>6 PK 1065 TM</b>
				ALT	UNTIL: 01.97; MTR-CODE: MIDR06.20.45E;41; AMP: 60; MOD: 340.18T		<b>5 PK 1010 TM</b>
				ALT	UNTIL: 01.97; MTR-CODE: MIDR06.20.45E;41; AMP: 80; MOD: 340.18T		<b>6 PK 1065 TM</b>
<b>340.19</b>							
9839 ccm	249 kW	MIDR 06.20.45 E/41	04.96 -	AC-C	MTR-CODE: MIDR 06.20.45 E;41; MOD: 340.19;340.19T		<b>AVX 13 x 1225 TM</b>
				ALT	FROM: 02.97; MTR-CODE: MIDR06.20.45E;41; MOD: 340.19;340.19T		<b>6 PK 1065 TM</b>
				ALT	UNTIL: 01.97; MTR-CODE: MIDR06.20.45E;41; AMP: 60; MOD: 340.19;340.19T		<b>5 PK 1010 TM</b>
				ALT	UNTIL: 01.97; MTR-CODE: MIDR06.20.45E;41; AMP: 80; MOD: 340.19;340.19T		<b>6 PK 1065 TM</b>
<b>340.19D</b>							
9839 ccm	249 kW	MIDR 06.20.45 E/41	04.96 -	AC-C	MTR-CODE: MIDR 06.20.45 E;41; MOD: 340.19D;340.19D;T		<b>AVX 13 x 1225 TM</b>
				ALT	FROM: 02.97; MTR-CODE: MIDR06.20.45E;41; MOD: 340.19D;340.19D;T		<b>6 PK 1065 TM</b>
				ALT	UNTIL: 01.97; MTR-CODE: MIDR06.20.45E;41; AMP: 60; MOD: 340.19D;340.19D;T		<b>5 PK 1010 TM</b>
				ALT	UNTIL: 01.97; MTR-CODE: MIDR06.20.45E;41; AMP: 80; MOD: 340.19D;340.19D;T		<b>6 PK 1065 TM</b>
<b>340.19D/T</b>							
9839 ccm	249 kW	MIDR 06.20.45 E/41	04.96 -	AC-C	MTR-CODE: MIDR 06.20.45 E;41; MOD: 340.19D;340.19D;T		<b>AVX 13 x 1225 TM</b>
				ALT	FROM: 02.97; MTR-CODE: MIDR06.20.45E;41; MOD: 340.19D;340.19D;T		<b>6 PK 1065 TM</b>
				ALT	UNTIL: 01.97; MTR-CODE: MIDR06.20.45E;41; AMP: 60; MOD: 340.19D;340.19D;T		<b>5 PK 1010 TM</b>
				ALT	UNTIL: 01.97; MTR-CODE: MIDR06.20.45E;41; AMP: 80; MOD: 340.19D;340.19D;T		<b>6 PK 1065 TM</b>



## RENAULT TRUCKS

### Premium

#### 340.19T

9839 ccm	249 kW	MIDR 06.20.45 E/41	04.96 -	AC-C	MTR-CODE: MIDR 06.20.45 E;41; MOD: 340.19;340.19T	AVX 13 x 1225 TM
				ALT	FROM: 02.97; MTR-CODE: MIDR06.20.45E;41; MOD: 340.19;340.19T	6 PK 1065 TM
				ALT	UNTIL: 01.97; MTR-CODE: MIDR06.20.45E;41; AMP: 60; MOD: 340.19;340.19T	5 PK 1010 TM
				ALT	UNTIL: 01.97; MTR-CODE: MIDR06.20.45E;41; AMP: 80; MOD: 340.19;340.19T	6 PK 1065 TM

#### 340.24

9839 ccm	249 kW	MIDR 06.20.45 E/41	04.96 -	AC-C	MTR-CODE: MIDR 06.20.45 E;41; MOD: 340.24	AVX 13 x 1225 TM
				ALT	FROM: 02.97; MTR-CODE: MIDR06.20.45E;41; MOD: 340.24	6 PK 1065 TM
				ALT	UNTIL: 01.97; MTR-CODE: MIDR06.20.45E;41; AMP: 60; MOD: 340.24	5 PK 1010 TM
				ALT	UNTIL: 01.97; MTR-CODE: MIDR06.20.45E;41; AMP: 80; MOD: 340.24	6 PK 1065 TM

#### 340.26

9839 ccm	249 kW	MIDR 06.20.45 E/41	04.96 -	AC-C	MTR-CODE: MIDR 06.20.45 E;41; MOD: 340.26	AVX 13 x 1225 TM
				ALT	FROM: 02.97; MTR-CODE: MIDR06.20.45E;41; MOD: 340.26	6 PK 1065 TM
				ALT	UNTIL: 01.97; MTR-CODE: MIDR06.20.45E;41; AMP: 60; MOD: 340.26	5 PK 1010 TM
				ALT	UNTIL: 01.97; MTR-CODE: MIDR06.20.45E;41; AMP: 80; MOD: 340.26	6 PK 1065 TM

#### 340.26D

9839 ccm	249 kW	MIDR 06.20.45 E/41	04.96 -	AC-C	MTR-CODE: MIDR 06.20.45 E;41; MOD: 340.26D	AVX 13 x 1225 TM
				ALT	FROM: 02.97; MTR-CODE: MIDR06.20.45E;41; MOD: 340.26D	6 PK 1065 TM
				ALT	UNTIL: 01.97; MTR-CODE: MIDR06.20.45E;41; AMP: 60; MOD: 340.26D	5 PK 1010 TM
				ALT	UNTIL: 01.97; MTR-CODE: MIDR06.20.45E;41; AMP: 80; MOD: 340.26D	6 PK 1065 TM

#### 370.18

11100 ccm	266 kW	dCi 11E	08.00 -	ALT	MOD: 370.18	5 PK 1025 TM
-----------	--------	---------	---------	-----	-------------	--------------

#### 370.18D

11100 ccm	266 kW	dCi 11E	08.00 -	ALT	MOD: 370.18D	5 PK 1025 TM
-----------	--------	---------	---------	-----	--------------	--------------

#### 370.24

11100 ccm	266 kW	dCi 11E	08.00 -	ALT	MOD: 370.24	5 PK 1025 TM
-----------	--------	---------	---------	-----	-------------	--------------

#### 370.26

11100 ccm	266 kW	dCi 11E	08.00 -	ALT	MOD: 370.26	5 PK 1025 TM
-----------	--------	---------	---------	-----	-------------	--------------

#### 370.26D

11100 ccm	266 kW	dCi 11E	08.00 -	ALT	MOD: 370.26D	5 PK 1025 TM
-----------	--------	---------	---------	-----	--------------	--------------

#### 385.18; 400.18

11100 ccm	280-288 kW	MIDR 06.23.56 A/41;MIDR 06.23.56 B/41	04.96 -	AC-C	MTR-CODE: MIDR 06.23.56 A;41; MOD: 385.18;400.18	AVX 13 x 1225 TM
				ALT	FROM: 02.97; MOD: 385.18;400.18	6 PK 1065 TM
				ALT	UNTIL: 01.97; AMP: 60; MOD: 385.18;400.18	5 PK 1010 TM
				ALT	UNTIL: 01.97; AMP: 80; MOD: 385.18;400.18	6 PK 1065 TM

#### 385.18T; 400.18T

11100 ccm	280-288 kW	MIDR 06.23.56 A/41;MIDR 06.23.56 B/41	04.96 -	AC-C	MTR-CODE: MIDR 06.23.56 A;41; MOD: 385.18;400.18	AVX 13 x 1225 TM
				ALT	FROM: 02.97; MOD: 385.18;400.18	6 PK 1065 TM
				ALT	UNTIL: 01.97; AMP: 60; MOD: 385.18;400.18	5 PK 1010 TM
				ALT	UNTIL: 01.97; AMP: 80; MOD: 385.18;400.18	6 PK 1065 TM

#### 385.19; 400.19

11100 ccm	280-288 kW	MIDR 06.23.56 A/41;MIDR 06.23.56 B/41	04.96 -	AC-C	MTR-CODE: MIDR 06.23.56 A;41; MOD: 385.19;400.19	AVX 13 x 1225 TM
				ALT	FROM: 02.97; MOD: 385.19;400.19	6 PK 1065 TM
				ALT	UNTIL: 01.97; AMP: 60; MOD: 385.19;400.19	5 PK 1010 TM
				ALT	UNTIL: 01.97; AMP: 80; MOD: 385.19;400.19	6 PK 1065 TM

#### 385.19T; 400.19T

11100 ccm	280-288 kW	MIDR 06.23.56 A/41;MIDR 06.23.56 B/41	04.96 -	AC-C	MTR-CODE: MIDR 06.23.56 A;41; MOD: 385.19;400.19	AVX 13 x 1225 TM
				ALT	FROM: 02.97; MOD: 385.19;400.19	6 PK 1065 TM
				ALT	UNTIL: 01.97; AMP: 60; MOD: 385.19;400.19	5 PK 1010 TM
				ALT	UNTIL: 01.97; AMP: 80; MOD: 385.19;400.19	6 PK 1065 TM



## RENAULT TRUCKS

### Premium

#### 385.24; 400.24

11100 ccm	280-288 kW	MIDR 06.23.56 A/41;MIDR 06.23.56 B/41	04.96 -	AC-C	MTR-CODE: MIDR 06.23.56 A;41; MOD: 385.24;400.24	<b>AVX 13 x 1225 TM</b>
				ALT	FROM: 02.97; MOD: 385.24,400.24	<b>6 PK 1065 TM</b>
				ALT	UNTIL: 01.97; AMP: 60; MOD: 385.24,400.24	<b>5 PK 1010 TM</b>
				ALT	UNTIL: 01.97; AMP: 80; MOD: 385.24,400.24	<b>6 PK 1065 TM</b>

#### 385.24T; 400.24T

11100 ccm	280-288 kW	MIDR 06.23.56 A/41;MIDR 06.23.56 B/41	09.96 -	AC-C	MTR-CODE: MIDR 06.23.56 A;41; MOD: 385.24;400.24	<b>AVX 13 x 1225 TM</b>
				ALT	FROM: 02.97; MOD: 385.24,400.24	<b>6 PK 1065 TM</b>
				ALT	UNTIL: 01.97; AMP: 60; MOD: 385.24,400.24	<b>5 PK 1010 TM</b>
				ALT	UNTIL: 01.97; AMP: 80; MOD: 385.24,400.24	<b>6 PK 1065 TM</b>

#### 385.26

11100 ccm	280 kW	MIDR 06.23.56 A/41	04.96 -	AC-C	MTR-CODE: MIDR 06.23.56 A;41; MOD: 385.26;385.26;400.26	<b>AVX 13 x 1225 TM</b>
				ALT	FROM: 02.97; MTR-CODE: MIDR06.23.56A;41; MOD: 385.26;385.26,400.26	<b>6 PK 1065 TM</b>
				ALT	UNTIL: 01.97; MTR-CODE: MIDR06.23.56A;41; AMP: 60; MOD: 385.26;385.26,400.26	<b>5 PK 1010 TM</b>
				ALT	UNTIL: 01.97; MTR-CODE: MIDR06.23.56A;41; AMP: 80; MOD: 385.26;385.26,400.26	<b>6 PK 1065 TM</b>

#### 385.26; 400.26

11100 ccm	280-288 kW	MIDR 06.23.56 A/41;MIDR 06.23.56 B/41	04.96 -	AC-C	MTR-CODE: MIDR 06.23.56 A;41; MOD: 385.26;385.26;400.26	<b>AVX 13 x 1225 TM</b>
				ALT	FROM: 02.97; MOD: 385.26;385.26,400.26	<b>6 PK 1065 TM</b>
				ALT	UNTIL: 01.97; AMP: 60; MOD: 385.26;385.26,400.26	<b>5 PK 1010 TM</b>
				ALT	UNTIL: 01.97; AMP: 80; MOD: 385.26;385.26,400.26	<b>6 PK 1065 TM</b>

#### 400.18D

11100 ccm	288 kW	MIDR 06.23.56 B/41	01.00 -	AC-C	MTR-CODE: MIDR 06.23.56 B;41; MOD: 400.18D;400.18D;T	<b>AVX 13 x 1225 TM</b>
				ALT	MTR-CODE: MIDR06.23.56B;41; MOD: 400.18D;400.18D;T	<b>6 PK 1065 TM</b>

#### 400.18D/T

11100 ccm	288 kW	MIDR 06.23.56 B/41	01.00 -	AC-C	MTR-CODE: MIDR 06.23.56 B;41; MOD: 400.18D;400.18D;T	<b>AVX 13 x 1225 TM</b>
				ALT	MTR-CODE: MIDR06.23.56B;41; MOD: 400.18D;400.18D;T	<b>6 PK 1065 TM</b>

#### 420.18D

11100 ccm	303 kW	dCi 11C	08.00 -	ALT	MOD: 420.18D	<b>5 PK 1025 TM</b>
-----------	--------	---------	---------	-----	--------------	---------------------

#### 420.18T

11100 ccm	303 kW	dCi 11 B/43;dCi 11C	08.00 -	ALT	MTR-CODE: dCi11B;43;dCi11C; AMP: 60; MOD: 420.18T	<b>5 PK 1045 TM</b>
				ALT	UNTIL: 04.02; MTR-CODE: dCi11B;43;dCi11C; MOD: 420.18T	<b>5 PK 1240 TM</b>

#### 420.24

11100 ccm	303 kW	dCi 11C	08.00 -	ALT	MOD: 420.24	<b>5 PK 1025 TM</b>
-----------	--------	---------	---------	-----	-------------	---------------------

#### 420.25

11100 ccm	303 kW	dCi 11C	08.00 -	ALT	MOD: 420.25	<b>5 PK 1025 TM</b>
-----------	--------	---------	---------	-----	-------------	---------------------

#### 420.26

11100 ccm	303 kW	dCi 11C	08.00 -	ALT	MOD: 420.26	<b>5 PK 1025 TM</b>
-----------	--------	---------	---------	-----	-------------	---------------------

### R

#### 310.16

11941 ccm	224-228 kW	MIDR 06.35.40 C	10.80 - 03.89	AC-C	MOD: R 310.16;R 310.16;T	<b>AVX 13 x 1150 TM</b>
				FAN	MOD: R 310.16;R 310.16;T; REQ: 2	<b>AVX 13 x 1175 TM</b>

#### 310.16/T

11941 ccm	224-228 kW	MIDR 06.35.40 C	10.80 - 03.89	AC-C	MOD: R 310.16;R 310.16;T	<b>AVX 13 x 1150 TM</b>
				FAN	MOD: R 310.16;R 310.16;T; REQ: 2	<b>AVX 13 x 1175 TM</b>

#### 310.17

11941 ccm	224-228 kW	MIDR 06.35.40 C	10.80 - 03.89	AC-C	MOD: R 310.17;R 310.17;T	<b>AVX 13 x 1150 TM</b>
				FAN	MOD: R 310.17;R 310.17;T; REQ: 2	<b>AVX 13 x 1175 TM</b>

#### 310.17/T

11941 ccm	224-228 kW	MIDR 06.35.40 C	10.80 - 03.89	AC-C	MOD: R 310.17;R 310.17;T	<b>AVX 13 x 1150 TM</b>
				FAN	MOD: R 310.17;R 310.17;T; REQ: 2	<b>AVX 13 x 1175 TM</b>

#### 310.19

11941 ccm	224-228 kW	MIDR 06.35.40 C	10.80 - 03.89	AC-C	MOD: R 310.19;R 310.19;T	<b>AVX 13 x 1150 TM</b>
				FAN	MOD: R 310.19;R 310.19;T; REQ: 2	<b>AVX 13 x 1175 TM</b>

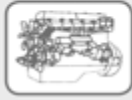

## RENAULT TRUCKS

R							
<b>310.19/T</b>							
11941 ccm	224-228 kW	MIDR 06.35.40 C	10.80 - 03.89	AC-C FAN	MOD: R 310.19;R 310.19;T MOD: R 310.19;R 310.19;T; REQ: 2	AVX 13 x 1150 TM AVX 13 x 1175 TM	
<b>310.22</b>							
11941 ccm	224-228 kW	MIDR 06.35.40 C	10.80 - 03.89	AC-C FAN	MOD: R 310.22;R 310.22;T MOD: R 310.22;R 310.22;T; REQ: 2	AVX 13 x 1150 TM AVX 13 x 1175 TM	
<b>310.22/T</b>							
11941 ccm	224-228 kW	MIDR 06.35.40 C	10.80 - 03.89	AC-C FAN	MOD: R 310.22;R 310.22;T MOD: R 310.22;R 310.22;T; REQ: 2	AVX 13 x 1150 TM AVX 13 x 1175 TM	
<b>330.17</b>							
9839 ccm	240-249 kW	MIDR 06.20.45 E	05.88 - 05.91	ALT	MOD: R330.17/R330.17/T	5 PK 1010 TM	
<b>330.17/T</b>							
9839 ccm	240-249 kW	MIDR 06.20.45 E	05.88 - 05.91	ALT	MOD: R330.17/R330.17/T	5 PK 1010 TM	
<b>330.19</b>							
9839 ccm	240-249 kW	MIDR 06.20.45 E	05.88 - 05.91	ALT	MOD: R330.19/R330.19/T	5 PK 1010 TM	
<b>330.19/T</b>							
9839 ccm	240-249 kW	MIDR 06.20.45 E	05.88 - 05.91	ALT	MOD: R330.19/R330.19/T	5 PK 1010 TM	
<b>330.24</b>							
9839 ccm	240-249 kW	MIDR 06.20.45 E	05.88 - 05.91	ALT	MOD: R330.24	5 PK 1010 TM	
<b>340.17</b>							
12024 ccm	259 kW	MIDR 06.35.40 G	03.86 - 01.90	AC-C	MTR-CODE: MIDR 06.35.40 G; MOD: R 340.17;R 340.17;T	AVX 13 x 1225 TM	
				AIR-C	MTR-CODE: MIDR 06.35.40 G; MOD: R 340.17;R 340.17;T	AVX 13 x 1225 TM	
				FAN	OE-NO.: 5000686548; MOD: R 340.17;R 340.17;T; REQ: 2	AVX 13 x 1175 TM	
				FAN	OE-NO.: 5000686548; MOD: R 340.17;R 340.17;T; REQ: 2	AVX 13 x 1200 TM	
<b>340.17/T</b>							
12024 ccm	259 kW	MIDR 06.35.40 G	03.86 - 01.90	AC-C	MTR-CODE: MIDR 06.35.40 G; MOD: R 340.17;R 340.17;T	AVX 13 x 1225 TM	
				AIR-C	MTR-CODE: MIDR 06.35.40 G; MOD: R 340.17;R 340.17;T	AVX 13 x 1225 TM	
				FAN	OE-NO.: 5000686548; MOD: R 340.17;R 340.17;T; REQ: 2	AVX 13 x 1175 TM	
				FAN	OE-NO.: 5000686548; MOD: R 340.17;R 340.17;T; REQ: 2	AVX 13 x 1200 TM	
<b>340.19</b>							
12024 ccm	259 kW	MIDR 06.35.40 G	03.86 - 01.90	AC-C	MTR-CODE: MIDR 06.35.40 G; MOD: R 340.19;R 340.19;T	AVX 13 x 1225 TM	
				AIR-C	MTR-CODE: MIDR 06.35.40 G; MOD: R 340.19;R 340.19;T	AVX 13 x 1225 TM	
				FAN	OE-NO.: 5000686548; MOD: R 340.19;R 340.19;T; REQ: 2	AVX 13 x 1175 TM	
				FAN	OE-NO.: 5000686548; MOD: R 340.19;R 340.19;T; REQ: 2	AVX 13 x 1200 TM	
<b>340.19/T</b>							
12024 ccm	259 kW	MIDR 06.35.40 G	03.86 - 01.90	AC-C	MTR-CODE: MIDR 06.35.40 G; MOD: R 340.19;R 340.19;T	AVX 13 x 1225 TM	
				AIR-C	MTR-CODE: MIDR 06.35.40 G; MOD: R 340.19;R 340.19;T	AVX 13 x 1225 TM	
				FAN	OE-NO.: 5000686548; MOD: R 340.19;R 340.19;T; REQ: 2	AVX 13 x 1175 TM	
				FAN	OE-NO.: 5000686548; MOD: R 340.19;R 340.19;T; REQ: 2	AVX 13 x 1200 TM	
<b>340.24</b>							
12024 ccm	259 kW	MIDR 06.35.40 G	03.86 - 01.90	AC-C	MTR-CODE: MIDR 06.35.40 G; MOD: R 340.24	AVX 13 x 1225 TM	
				AIR-C	MTR-CODE: MIDR 06.35.40 G; MOD: R 340.24	AVX 13 x 1225 TM	
				FAN	OE-NO.: 5000686548; MOD: R 340.24; REQ: 2	AVX 13 x 1175 TM	
				FAN	OE-NO.: 5000686548; MOD: R 340.24; REQ: 2	AVX 13 x 1200 TM	
<b>340ti.16/T</b>							
9839 ccm	249 kW	MIDR 06.20.45 E	01.90 - 05.91	AC-C ALT	MOD: R 340ti.16;T MOD: R340ti.16/T	AVX 13 x 1400 TM 5 PK 1010 TM	
<b>340ti.17</b>							
9839 ccm	249 kW	MIDR 06.20.45 E	01.90 - 05.91	AC-C ALT	MOD: R 340ti.17 MOD: R340ti.17	AVX 13 x 1400 TM 5 PK 1010 TM	
<b>340ti.18</b>							
9839 ccm	249 kW	MIDR 06.20.45 E	01.90 - 05.91	AC-C ALT	MOD: R 340ti.18 MOD: R340ti.18	AVX 13 x 1400 TM 5 PK 1010 TM	

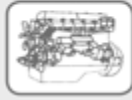

## RENAULT TRUCKS

R							
<b>340ti.18/T</b>							
9839 ccm	249 kW	MIDR 06.20.45 E	01.90 - 05.91	AC-C ALT	MOD: R 340ti.18 MOD: R340ti.18		AVX 13 x 1400 TM 5 PK 1010 TM
<b>340ti.19</b>							
9839 ccm	249 kW	MIDR 06.20.45 E	01.90 - 05.91	AC-C ALT	MOD: R 340ti.19 MOD: R340ti.19		AVX 13 x 1400 TM 5 PK 1010 TM
<b>340ti.19/T</b>							
9839 ccm	249 kW	MIDR 06.20.45 E	01.90 - 05.91	AC-C ALT	MOD: R 340ti.19 MOD: R340ti.19		AVX 13 x 1400 TM 5 PK 1010 TM
<b>340ti.24</b>							
9839 ccm	249 kW	MIDR 06.20.45 E	01.90 - 05.91	AC-C ALT	MOD: R 340ti.24 MOD: R340ti.24		AVX 13 x 1400 TM 5 PK 1010 TM
<b>340ti.26</b>							
9839 ccm	249 kW	MIDR 06.20.45 E	01.90 - 05.91	AC-C ALT	MOD: R 340ti.26 MOD: R340ti.26		AVX 13 x 1400 TM 5 PK 1010 TM
<b>350.17</b>							
12024 ccm	259 kW	MIDR 06.35.40 G	01.90 - 05.91	AC-C FAN	MOD: R 350.17;R 350.17;T MOD: R 350.17;R 350.17;T; REQ: 2		AVX 13 x 1225 TM AVX 13 x 1200 TM
<b>350.17/T</b>							
12024 ccm	259 kW	MIDR 06.35.40 G	01.90 - 05.91	AC-C FAN	MOD: R 350.17;R 350.17;T MOD: R 350.17;R 350.17;T; REQ: 2		AVX 13 x 1225 TM AVX 13 x 1200 TM
<b>350.18</b>							
12024 ccm	259 kW	MIDR 06.35.40 G	01.90 - 05.91	AC-C FAN	MOD: R 350.18;R 350.18;T MOD: R 350.18;R 350.18;T; REQ: 2		AVX 13 x 1225 TM AVX 13 x 1200 TM
<b>350.18/T</b>							
12024 ccm	259 kW	MIDR 06.35.40 G	01.90 - 05.91	AC-C FAN	MOD: R 350.18;R 350.18;T MOD: R 350.18;R 350.18;T; REQ: 2		AVX 13 x 1225 TM AVX 13 x 1200 TM
<b>350.19</b>							
12024 ccm	259 kW	MIDR 06.35.40 G	01.90 - 05.91	AC-C FAN	MOD: R 350.19;R 350.19;T MOD: R 350.19;R 350.19;T; REQ: 2		AVX 13 x 1225 TM AVX 13 x 1200 TM
<b>350.19/T</b>							
12024 ccm	259 kW	MIDR 06.35.40 G	01.90 - 05.91	AC-C FAN	MOD: R 350.19;R 350.19;T MOD: R 350.19;R 350.19;T; REQ: 2		AVX 13 x 1225 TM AVX 13 x 1200 TM
<b>350.19/TB</b>							
12024 ccm	259 kW	MIDR 06.35.40 G	01.90 - 05.91	AC-C FAN	MOD: R 350.19;R 350.19;T MOD: R 350.19;R 350.19;T; REQ: 2		AVX 13 x 1225 TM AVX 13 x 1200 TM
<b>350.24</b>							
12024 ccm	259 kW	MIDR 06.35.40 G	01.90 - 05.91	AC-C FAN	MOD: R 350.24 MOD: R 350.24; REQ: 2		AVX 13 x 1225 TM AVX 13 x 1200 TM
<b>350.26</b>							
12024 ccm	259 kW	MIDR 06.35.40 G	01.90 - 05.91	AC-C FAN	MOD: R 350.26 MOD: R 350.26; REQ: 2		AVX 13 x 1225 TM AVX 13 x 1200 TM
<b>365.17/T</b>							
11941 ccm	275 kW	MIDR 06.35.40 H	10.87 - 05.90	AC-C AC-C FAN	FROM: 06.88; MOD: R 365.17;T UNTIL: 05.88; MOD: R 365.17;T MOD: R 365.17;T; REQ: 2		AVX 13 x 1225 TM AVX 13 x 1150 TM AVX 13 x 1175 TM
<b>365.19</b>							
11941 ccm	275 kW	MIDR 06.35.40 H	10.87 - 05.90	AC-C AC-C FAN	FROM: 06.88; MOD: R 365.19;R 365.19;T UNTIL: 05.88; MOD: R 365.19;R 365.19;T MOD: R 365.19;R 365.19;T; REQ: 2		AVX 13 x 1225 TM AVX 13 x 1150 TM AVX 13 x 1175 TM
<b>365.19/T</b>							
11941 ccm	275 kW	MIDR 06.35.40 H	10.87 - 05.90	AC-C AC-C FAN	FROM: 06.88; MOD: R 365.19;R 365.19;T UNTIL: 05.88; MOD: R 365.19;R 365.19;T MOD: R 365.19;R 365.19;T; REQ: 2		AVX 13 x 1225 TM AVX 13 x 1150 TM AVX 13 x 1175 TM
<b>365.24</b>							
11941 ccm	275 kW	MIDR 06.35.40 H	10.87 - 05.90	AC-C AC-C FAN	FROM: 06.88; MOD: R 365.24 UNTIL: 05.88; MOD: R 365.24 MOD: R 365.24; REQ: 2		AVX 13 x 1225 TM AVX 13 x 1150 TM AVX 13 x 1175 TM
<b>370.16</b>							
14886 ccm	268 kW	MIVS 08.35.30 F	10.83 - 07.85	AC-C FAN	MOD: R 370.16;R 370.16;T MOD: R 370.16;R 370.16;T; REQ: 2		AVX 13 x 1400 TM AVX 13 x 1075 TM
<b>370.16/T</b>							
14886 ccm	268 kW	MIVS 08.35.30 F	10.83 - 07.85	AC-C FAN	MOD: R 370.16;R 370.16;T MOD: R 370.16;R 370.16;T; REQ: 2		AVX 13 x 1400 TM AVX 13 x 1075 TM

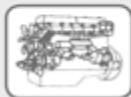

## RENAULT TRUCKS

R							
<b>370.22/T</b>							
14886 ccm	268 kW	MIVS 08.35.30 F	10.83 - 07.85	AC-C FAN	MOD: R 370.22;T MOD: R 370.22;T; REQ: 2	AVX 13 x 1400 TM AVX 13 x 1075 TM	
<b>380.17</b>							
12024 ccm	275 kW	MIDR 06.35.40 H	01.90 - 05.91	AC-C FAN	MOD: R 380.17 MOD: R 380.17; REQ: 2	AVX 13 x 1225 TM AVX 13 x 1175 TM	
<b>380.18</b>							
12024 ccm	275 kW	MIDR 06.35.40 H	01.90 - 05.91	AC-C FAN	MOD: R 380.18;R 380.18;T MOD: R 380.18;R 380.18;T; REQ: 2	AVX 13 x 1225 TM AVX 13 x 1175 TM	
<b>380.18/T</b>							
12024 ccm	275 kW	MIDR 06.35.40 H	01.90 - 05.91	AC-C FAN	MOD: R 380.18;R 380.18;T MOD: R 380.18;R 380.18;T; REQ: 2	AVX 13 x 1225 TM AVX 13 x 1175 TM	
<b>380.19</b>							
12024 ccm	275 kW	MIDR 06.35.40 H	01.90 - 05.91	AC-C FAN	MOD: R 380.19;R 380.19;T MOD: R 380.19;R 380.19;T; REQ: 2	AVX 13 x 1225 TM AVX 13 x 1175 TM	
<b>380.19/T</b>							
12024 ccm	275 kW	MIDR 06.35.40 H	01.90 - 05.91	AC-C FAN	MOD: R 380.19;R 380.19;T MOD: R 380.19;R 380.19;T; REQ: 2	AVX 13 x 1225 TM AVX 13 x 1175 TM	
<b>380.19/TB</b>							
12024 ccm	275 kW	MIDR 06.35.40 H	01.90 - 05.91	AC-C FAN	MOD: R 380.19;R 380.19;T MOD: R 380.19;R 380.19;T; REQ: 2	AVX 13 x 1225 TM AVX 13 x 1175 TM	
<b>380.22/T</b>							
12024 ccm	275 kW	MIDR 06.35.40 H	01.90 - 05.91	AC-C FAN	MOD: R 380.22;T MOD: R 380.22;T; REQ: 2	AVX 13 x 1225 TM AVX 13 x 1175 TM	
<b>380.24</b>							
12024 ccm	275 kW	MIDR 06.35.40 H	01.90 - 05.91	AC-C FAN	MOD: R 380.24 MOD: R 380.24; REQ: 2	AVX 13 x 1225 TM AVX 13 x 1175 TM	
<b>380.25</b>							
12024 ccm	275 kW	MIDR 06.35.40 H	01.90 - 05.91	AC-C FAN	MOD: R 380.25;R 380.25;T MOD: R 380.25;R 380.25;T; REQ: 2	AVX 13 x 1225 TM AVX 13 x 1175 TM	
<b>380.25/T</b>							
12024 ccm	275 kW	MIDR 06.35.40 H	01.90 - 05.91	AC-C FAN	MOD: R 380.25;R 380.25;T MOD: R 380.25;R 380.25;T; REQ: 2	AVX 13 x 1225 TM AVX 13 x 1175 TM	
<b>380.26</b>							
12024 ccm	275 kW	MIDR 06.35.40 H	01.90 - 05.91	AC-C FAN	MOD: R 380.26;R 380.26;T MOD: R 380.26;R 380.26;T; REQ: 2	AVX 13 x 1225 TM AVX 13 x 1175 TM	
<b>380.26/T</b>							
12024 ccm	275 kW	MIDR 06.35.40 H	01.90 - 05.91	AC-C FAN	MOD: R 380.26;R 380.26;T MOD: R 380.26;R 380.26;T; REQ: 2	AVX 13 x 1225 TM AVX 13 x 1175 TM	
<b>390.16</b>							
14886 ccm	286-296 kW	MIVR 08.35.30 C	07.85 - 03.89	AC-C AIR-C	MTR-CODE: MIVR 08.35.30 C; MOD: R 390.16;R 390.16;T MTR-CODE: MIVR 08.35.30 C; MOD: R 390.16;R 390.16;T	AVX 13 x 1400 TM AVX 13 x 1400 TM	
<b>390.16/T</b>							
14886 ccm	286-296 kW	MIVR 08.35.30 C	07.85 - 03.89	AC-C AIR-C	MTR-CODE: MIVR 08.35.30 C; MOD: R 390.16;R 390.16;T MTR-CODE: MIVR 08.35.30 C; MOD: R 390.16;R 390.16;T	AVX 13 x 1400 TM AVX 13 x 1400 TM	
<b>390.17</b>							
14886 ccm	286-296 kW	MIVR 08.35.30 C	07.85 - 03.89	AC-C AIR-C	MTR-CODE: MIVR 08.35.30 C; MOD: R 390.17;R 390.17;T MTR-CODE: MIVR 08.35.30 C; MOD: R 390.17;R 390.17;T	AVX 13 x 1400 TM AVX 13 x 1400 TM	
<b>390.17/T</b>							
14886 ccm	286-296 kW	MIVR 08.35.30 C	07.85 - 03.89	AC-C AIR-C	MTR-CODE: MIVR 08.35.30 C; MOD: R 390.17;R 390.17;T MTR-CODE: MIVR 08.35.30 C; MOD: R 390.17;R 390.17;T	AVX 13 x 1400 TM AVX 13 x 1400 TM	
<b>390.22/T</b>							
14886 ccm	286-296 kW	MIVR 08.35.30 C	07.85 - 03.89	AC-C AIR-C	MTR-CODE: MIVR 08.35.30 C; MOD: R 390.22;T MTR-CODE: MIVR 08.35.30 C; MOD: R 390.22;T	AVX 13 x 1400 TM AVX 13 x 1400 TM	
<b>390.24</b>							
14886 ccm	286-296 kW	MIVR 08.35.30 C	07.85 - 03.89	AC-C AIR-C	MTR-CODE: MIVR 08.35.30 C; MOD: R 390.24;R 390.24;T MTR-CODE: MIVR 08.35.30 C; MOD: R 390.24;R 390.24;T	AVX 13 x 1400 TM AVX 13 x 1400 TM	

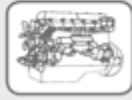

## RENAULT TRUCKS

R							
<b>390.24/T</b>							
14886 ccm	286-296 kW	MIVR 08.35.30 C	07.85 - 03.89	AC-C	MTR-CODE: MIVR 08.35.30 C; MOD: R 390.24;R 390.24;T		<b>AVX 13 x 1400 TM</b>
				AIR-C	MTR-CODE: MIVR 08.35.30 C; MOD: R 390.24;R 390.24;T		<b>AVX 13 x 1400 TM</b>
<b>420.17</b>							
14886 ccm	302-310 kW	MIVR 08.35.30 G;MIVR 08.35.30 H	10.88 - 10.91	AC-C	MTR-CODE: MIVR 08.35.30 G; MOD: R 420.17;R 420.17;T		<b>AVX 13 x 1400 TM</b>
				FAN	MTR-CODE: MIVR 08.35.30 G; MOD: R 420.17;R 420.17;T; REQ: 2		<b>AVX 13 x 1075 TM</b>
<b>420.17/T</b>							
14886 ccm	302-310 kW	MIVR 08.35.30 G;MIVR 08.35.30 H	10.88 - 10.91	AC-C	MTR-CODE: MIVR 08.35.30 G; MOD: R 420.17;R 420.17;T		<b>AVX 13 x 1400 TM</b>
				FAN	MTR-CODE: MIVR 08.35.30 G; MOD: R 420.17;R 420.17;T; REQ: 2		<b>AVX 13 x 1075 TM</b>
<b>420.19</b>							
14886 ccm	302-310 kW	MIVR 08.35.30 G;MIVR 08.35.30 H	10.88 - 10.91	AC-C	MTR-CODE: MIVR 08.35.30 G; MOD: R 420.19;R 420.19;T		<b>AVX 13 x 1400 TM</b>
				FAN	MTR-CODE: MIVR 08.35.30 G; MOD: R 420.19;R 420.19;T; REQ: 2		<b>AVX 13 x 1075 TM</b>
<b>420.19/T</b>							
14886 ccm	302-310 kW	MIVR 08.35.30 G;MIVR 08.35.30 H	10.88 - 10.91	AC-C	MTR-CODE: MIVR 08.35.30 G; MOD: R 420.19;R 420.19;T		<b>AVX 13 x 1400 TM</b>
				FAN	MTR-CODE: MIVR 08.35.30 G; MOD: R 420.19;R 420.19;T; REQ: 2		<b>AVX 13 x 1075 TM</b>
<b>420.24</b>							
14886 ccm	302-310 kW	MIVR 08.35.30 G;MIVR 08.35.30 H	10.88 - 10.91	AC-C	MTR-CODE: MIVR 08.35.30 G; MOD: R 420.24;R 420.24;T		<b>AVX 13 x 1400 TM</b>
				FAN	MTR-CODE: MIVR 08.35.30 G; MOD: R 420.24;R 420.24;T; REQ: 2		<b>AVX 13 x 1075 TM</b>
<b>420.24/T</b>							
14886 ccm	302-310 kW	MIVR 08.35.30 G;MIVR 08.35.30 H	10.88 - 10.91	AC-C	MTR-CODE: MIVR 08.35.30 G; MOD: R 420.24;R 420.24;T		<b>AVX 13 x 1400 TM</b>
				FAN	MTR-CODE: MIVR 08.35.30 G; MOD: R 420.24;R 420.24;T; REQ: 2		<b>AVX 13 x 1075 TM</b>
<b>420.35/T</b>							
14886 ccm	302-310 kW	MIVR 08.35.30 G;MIVR 08.35.30 H	10.88 - 10.91	AC-C	MTR-CODE: MIVR 08.35.30 G; MOD: R 420.35;T		<b>AVX 13 x 1400 TM</b>
				FAN	MTR-CODE: MIVR 08.35.30 G; MOD: R 420.35;T; REQ: 2		<b>AVX 13 x 1075 TM</b>

## SCANIA

Serie 3							
<b>113.E/320</b>							
11020 ccm	235-239 kW	DSC 11.16;DSC 11.17;DSC 11.21	01.90 - 12.96	AC-C	MTR-CODE: DSC 11.16;DSC 11.17; MOD: 113 E;320		<b>AVX 13 x 1175 TM</b>
				ALT	MTR-CODE: DSC 11.16;DSC 11.17; MOD: 113 E;320; REQ: 2		<b>AVX 13 x 1575 TM</b>
<b>113.E/360</b>							
11020 ccm	265-267 kW	DSC 11.13;DSC 11.18;DSC 11.23;DSC 11.30	01.90 - 12.96	AC-C	MTR-CODE: DSC 11.13;DSC 11.18; MOD: 113 E;360		<b>AVX 13 x 1175 TM</b>
				ALT	MTR-CODE: DSC 11.13;DSC 11.18; MOD: 113 E;360; REQ: 2		<b>AVX 13 x 1575 TM</b>
<b>113.E/380</b>							
11020 ccm	280 kW	DSC 11.22;DSC 11.70	01.91 - 12.96	AC-C	MOD: 113 E;380		<b>AVX 13 x 1175 TM</b>
				ALT	MOD: 113 E;380; REQ: 2		<b>AVX 13 x 1575 TM</b>
<b>113.H/310</b>							
11020 ccm	228-229 kW	DS 11.34;DS 11.73;DS 11.75;DSC 11.06;DSC 11.08	05.88 - 12.91	AC-C	MTR-CODE: DS 11.34;DS 11.73; MOD: 113 H;310		<b>AVX 13 x 1175 TM</b>
				ALT	MTR-CODE: DS 11.34;DS 11.73; MOD: 113 H;310; REQ: 2		<b>AVX 13 x 1600 TM</b>
				ALT	MTR-CODE: DS 11.34;DS 11.73;DSC 11.06; MOD: 113 H;310; REQ: 2		<b>AVX 13 x 1575 TM</b>
		DS 11.34;DS 11.73;DSC 11.06		AC-C	MTR-CODE: DS 11.34;DS 11.73; MOD: 113 H;310		<b>AVX 13 x 1175 TM</b>
				ALT	MTR-CODE: DS 11.34;DS 11.73; MOD: 113 H;310; REQ: 2		<b>AVX 13 x 1600 TM</b>
				ALT	MTR-CODE: DS 11.34;DS 11.73;DSC 11.06; MOD: 113 H;310; REQ: 2		<b>AVX 13 x 1575 TM</b>



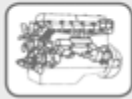

## SCANIA

### Serie 3

#### 113.H/320

11020 ccm	235-239 kW	DSC 11.16;DSC 11.17;DSC 11.21	05.88 - 12.96	AC-C	MTR-CODE: DSC 11.16;DSC 11.16; MOD: 113 H;320	AVX 13 x 1175 TM
				ALT	MTR-CODE: DSC 11.16;DSC 11.16; MOD: 113 H;320; REQ: 2	AVX 13 x 1575 TM
	239 kW	DSC 11.16		AC-C	MTR-CODE: DSC 11.16;DSC 11.16; MOD: 113 H;320	AVX 13 x 1175 TM
				ALT	MTR-CODE: DSC 11.16;DSC 11.16; MOD: 113 H;320; REQ: 2	AVX 13 x 1575 TM

#### 113.H/360

11020 ccm	265-267 kW	DSC 11.13;DSC 11.18;DSC 11.23;DSC 11.30	05.88 - 12.96	AC-C	MTR-CODE: DSC 11.13;DSC 11.13; MOD: 113 H;360	AVX 13 x 1175 TM
				ALT	MTR-CODE: DSC 11.13;DSC 11.13; MOD: 113 H;360; REQ: 2	AVX 13 x 1575 TM
	267 kW	DSC 11.13		AC-C	MTR-CODE: DSC 11.13;DSC 11.13; MOD: 113 H;360	AVX 13 x 1175 TM
				ALT	MTR-CODE: DSC 11.13;DSC 11.13; MOD: 113 H;360; REQ: 2	AVX 13 x 1575 TM

#### 113.H/380

11020 ccm	280 kW	DSC 11.22;DSC 11.70	01.91 - 12.96	AC-C	MOD: 113 H;380	AVX 13 x 1175 TM
				ALT	MOD: 113 H;380; REQ: 2	AVX 13 x 1575 TM

#### 113.M/320

11020 ccm	235-239 kW	DSC 11.16;DSC 11.17;DSC 11.21	05.88 - 12.96	AC-C	MTR-CODE: DSC 11.16;DSC 11.16; MOD: 113 M;320	AVX 13 x 1175 TM
				ALT	MTR-CODE: DSC 11.16;DSC 11.16; MOD: 113 M;320; REQ: 2	AVX 13 x 1575 TM
	239 kW	DSC 11.16		AC-C	MTR-CODE: DSC 11.16;DSC 11.16; MOD: 113 M;320	AVX 13 x 1175 TM
				ALT	MTR-CODE: DSC 11.16;DSC 11.16; MOD: 113 M;320; REQ: 2	AVX 13 x 1575 TM

#### 113.M/360

11020 ccm	265-267 kW	DSC 11.13;DSC 11.18;DSC 11.23;DSC 11.30	05.88 - 12.96	AC-C	MTR-CODE: DSC 11.13;DSC 11.13; MOD: 113 M;360	AVX 13 x 1175 TM
				ALT	MTR-CODE: DSC 11.13;DSC 11.13; MOD: 113 M;360; REQ: 2	AVX 13 x 1575 TM
	267 kW	DSC 11.13		AC-C	MTR-CODE: DSC 11.13;DSC 11.13; MOD: 113 M;360	AVX 13 x 1175 TM
				ALT	MTR-CODE: DSC 11.13;DSC 11.13; MOD: 113 M;360; REQ: 2	AVX 13 x 1575 TM

#### 113.M/380

11020 ccm	280 kW	DSC 11.22;DSC 11.70	01.91 - 12.96	AC-C	MOD: 113 M;380	AVX 13 x 1175 TM
				ALT	MOD: 113 M;380; REQ: 2	AVX 13 x 1575 TM

#### 143.E/420

14190 ccm	309 kW	DSC 14.08	01.91 - 12.96	ALT	MOD: 143 E;420; - AC	AVX 13 x 1150 TM
				ALT	MOD: 143 E;420; + AC	AVX 13 x 1300 TM

#### 143.E/450

14190 ccm	331-333 kW	DSC 14.03;DSC 14.10	01.90 - 12.96	ALT	MOD: 143 E;450; - AC	AVX 13 x 1150 TM
				ALT	MOD: 143 E;450; + AC	AVX 13 x 1300 TM

#### 143.E/500

14190 ccm	368 kW	DSC 14.09;DSC 14.16	01.91 - 12.96	ALT	MTR-CODE: DSC 14.09;DSC 14.09;DSC 14.16; MOD: 143 E;500; - AC	AVX 13 x 1150 TM
				ALT	MTR-CODE: DSC 14.09;DSC 14.09;DSC 14.16; MOD: 143 E;500; + AC	AVX 13 x 1300 TM

#### 143.H/400

14190 ccm	297 kW	DSC 14.06	05.88 - 12.91	ALT	MOD: 143 H;400; - AC	AVX 13 x 1175 TM
				ALT	MOD: 143 H;400; + AC	AVX 13 x 1300 TM

#### 143.H/420

14190 ccm	309 kW	DSC 14.08	01.91 - 12.96	ALT	MOD: 143 H;420; - AC	AVX 13 x 1150 TM
				ALT	MOD: 143 H;420; + AC	AVX 13 x 1300 TM

#### 143.H/450

14190 ccm	331 kW	DSC 14.03	05.88 - 12.96	ALT	MTR-CODE: DSC 14.03;DSC 14.03; MOD: 143 H;450; - AC	AVX 13 x 1150 TM
				ALT	MTR-CODE: DSC 14.03;DSC 14.03; MOD: 143 H;450; + AC	AVX 13 x 1300 TM
	331-333 kW	DSC 14.03;DSC 14.10		ALT	MTR-CODE: DSC 14.03;DSC 14.03; MOD: 143 H;450; - AC	AVX 13 x 1150 TM
				ALT	MTR-CODE: DSC 14.03;DSC 14.03; MOD: 143 H;450; + AC	AVX 13 x 1300 TM

#### 143.H/470

14190 ccm	346 kW	DSC 14.04	03.88 - 05.91	ALT	MOD: 143 H;470; - AC	AVX 13 x 1150 TM
-----------	--------	-----------	---------------	-----	----------------------	------------------

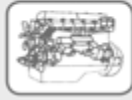

## SCANIA

### Serie 3

#### 143.H/470

14190 ccm 346 kW DSC 14.04 03.88 - 05.91 ALT MOD: 143 H;470; + AC AVX 13 x 1300 TM

#### 143.H/500

14190 ccm 368 kW DSC 14.09;DSC 14.16 01.91 - 12.96 ALT MTR-CODE: DSC 14.09;DSC 14.09;DSC 14.16; MOD: 143 H;500; - AC AVX 13 x 1150 TM  
ALT MTR-CODE: DSC 14.09;DSC 14.09;DSC 14.16; MOD: 143 H;500; + AC AVX 13 x 1300 TM

#### 143.M/420

14190 ccm 309 kW DSC 14.08 01.91 - 12.96 ALT MOD: 143 M;420; - AC AVX 13 x 1150 TM  
ALT MOD: 143 M;420; + AC AVX 13 x 1300 TM

#### 143.M/450

14190 ccm 331 kW DSC 14.03 05.88 - 12.96 ALT MTR-CODE: DSC 14.03;DSC 14.03; MOD: 143 M;450; - AC AVX 13 x 1150 TM  
ALT MTR-CODE: DSC 14.03;DSC 14.03; MOD: 143 M;450; + AC AVX 13 x 1300 TM  
331-333 kW DSC 14.03;DSC 14.10 ALT MTR-CODE: DSC 14.03;DSC 14.03; MOD: 143 M;450; - AC AVX 13 x 1150 TM  
ALT MTR-CODE: DSC 14.03;DSC 14.03; MOD: 143 M;450; + AC AVX 13 x 1300 TM

#### 143.M/470

14190 ccm 346 kW DSC 14.04 03.88 - 05.91 ALT MOD: 143 M;470; - AC AVX 13 x 1150 TM  
ALT MOD: 143 M;470; + AC AVX 13 x 1300 TM

#### 143.M/500

14190 ccm 368 kW DSC 14.09;DSC 14.16 01.91 - 12.96 ALT MTR-CODE: DSC 14.09;DSC 14.09;DSC 14.16; MOD: 143 M;500; - AC AVX 13 x 1150 TM  
ALT MTR-CODE: DSC 14.09;DSC 14.09;DSC 14.16; MOD: 143 M;500; + AC AVX 13 x 1300 TM

#### 93.H/220

8475 ccm 162 kW DSC 9.10 12.91 - 12.96 AC-C UNTIL CHA-NO.: 1150611; MTR-CODE: DSC 9.10; MOD: 93 T;220; S AVX 13 x 1750 TM  
AC-C UNTIL CHA-NO.: 4301979; MTR-CODE: DSC 9.10; MOD: 93 H;220; NL AVX 13 x 1750 TM  
AC-C UNTIL CHA-NO.: 4301979; MTR-CODE: DSC 9.10; MOD: 93 T;220; NL AVX 13 x 1750 TM  
ALT FROM CHA-NO.: 1150612; MTR-CODE: DSC 9.10; MOD: 93 H;220; S AVX 13 x 1725  
ALT FROM CHA-NO.: 1150612; MTR-CODE: DSC 9.10; MOD: 93 T;220; S AVX 13 x 1725  
ALT FROM CHA-NO.: 4301980; MTR-CODE: DSC 9.10; MOD: 93 H;220; NL AVX 13 x 1725  
ALT FROM CHA-NO.: 4301980; MTR-CODE: DSC 9.10; MOD: 93 T;220; NL AVX 13 x 1725  
ALT MTR-CODE: DSC 9.10; MOD: 93 H;220; REQ: 2 AVX 13 x 1825 TM  
ALT MTR-CODE: DSC 9.10; MOD: 93 T;220; REQ: 2 AVX 13 x 1825 TM  
ALT UNTIL CHA-NO.: 1150611; MTR-CODE: DSC 9.10; MOD: 93 H;220; S AVX 13 x 1750 TM

#### 93.H/250

8475 ccm 185 kW DS 9.05 03.88 - 12.96 AC-C UNTIL CHA-NO.: 1150611; MTR-CODE: DS 9.05;DS 9.05; MOD: 93 T;250; S AVX 13 x 1750 TM  
AC-C UNTIL CHA-NO.: 4301979; MTR-CODE: DS 9.05;DS 9.05; MOD: 93 H;250; NL AVX 13 x 1750 TM  
AC-C UNTIL CHA-NO.: 4301979; MTR-CODE: DS 9.05;DS 9.05; MOD: 93 T;250; NL AVX 13 x 1750 TM  
ALT FROM CHA-NO.: 1150612; MTR-CODE: DS 9.05;DS 9.05; MOD: 93 H;250; S AVX 13 x 1725  
ALT FROM CHA-NO.: 1150612; MTR-CODE: DS 9.05;DS 9.05; MOD: 93 T;250; S AVX 13 x 1725  
ALT FROM CHA-NO.: 4301980; MTR-CODE: DS 9.05;DS 9.05; MOD: 93 H;250; NL AVX 13 x 1725  
ALT FROM CHA-NO.: 4301980; MTR-CODE: DS 9.05;DS 9.05; MOD: 93 T;250; NL AVX 13 x 1725  
ALT MTR-CODE: DS 9.05;DS 9.05; MOD: 93 H;250; REQ: 2 AVX 13 x 1825 TM  
ALT MTR-CODE: DS 9.05;DS 9.05; MOD: 93 T;250; REQ: 2 AVX 13 x 1825 TM  
ALT UNTIL CHA-NO.: 1150611; MTR-CODE: DS 9.05;DS 9.05; MOD: 93 H;250; S AVX 13 x 1750 TM  
DS 9.05;DSC 9.07 AC-C UNTIL CHA-NO.: 1150611; MTR-CODE: DS 9.05;DS 9.05; MOD: 93 T;250; S AVX 13 x 1750 TM  
AC-C UNTIL CHA-NO.: 4301979; MTR-CODE: DS 9.05;DS 9.05; MOD: 93 H;250; NL AVX 13 x 1750 TM  
AC-C UNTIL CHA-NO.: 4301979; MTR-CODE: DS 9.05;DS 9.05; MOD: 93 T;250; NL AVX 13 x 1750 TM

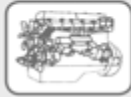

## SCANIA

### Serie 3

#### 93.H/250

8475 ccm	185 kW	DS 9.05;DSC 9.07	03.88 - 12.96	AC-C	UNTIL CHA-NO.: 4301979; MTR-CODE: DS 9.05;DSC 9.07; MOD: T 93 H;250; NL	<b>AVX 13 x 1750 TM</b>
				ALT	FROM CHA-NO.: 1150612; MTR-CODE: DS 9.05;DS 9.05; MOD: 93 H;250; S	<b>AVX 13 x 1725</b>
				ALT	FROM CHA-NO.: 1150612; MTR-CODE: DS 9.05;DS 9.05; MOD: 93 T;250; S	<b>AVX 13 x 1725</b>
				ALT	FROM CHA-NO.: 1150612; MTR-CODE: DS 9.05;DSC 9.07; MOD: T 93 H;250; S	<b>AVX 13 x 1725</b>
				ALT	FROM CHA-NO.: 4301980; MTR-CODE: DS 9.05;DS 9.05; MOD: 93 H;250; NL	<b>AVX 13 x 1725</b>
				ALT	FROM CHA-NO.: 4301980; MTR-CODE: DS 9.05;DS 9.05; MOD: 93 T;250; NL	<b>AVX 13 x 1725</b>
				ALT	FROM CHA-NO.: 4301980; MTR-CODE: DS 9.05;DSC 9.07; MOD: T 93 H;250; NL	<b>AVX 13 x 1725</b>
				ALT	MOD: T 93 H;250; REQ: 2	<b>AVX 13 x 1825 TM</b>
				ALT	MTR-CODE: DS 9.05;DS 9.05; MOD: 93 H;250; REQ: 2	<b>AVX 13 x 1825 TM</b>
				ALT	MTR-CODE: DS 9.05;DS 9.05; MOD: 93 T;250; REQ: 2	<b>AVX 13 x 1825 TM</b>
				ALT	UNTIL CHA-NO.: 1150611; MTR-CODE: DS 9.05;DS 9.05; MOD: 93 H;250; S	<b>AVX 13 x 1750 TM</b>
				ALT	UNTIL CHA-NO.: 1150611; MTR-CODE: DS 9.05;DSC 9.07; MOD: T 93 H;250; S	<b>AVX 13 x 1750 TM</b>

#### 93.H/280

8475 ccm	207-208 kW	DSC 9.02;DSC 9.08	12.91 - 12.96	AC-C	UNTIL CHA-NO.: 1150611; MTR-CODE: DSC 9.02;DSC 9.08; MOD: 93 T;280; S	<b>AVX 13 x 1750 TM</b>
				AC-C	UNTIL CHA-NO.: 4301979; MTR-CODE: DSC 9.02;DSC 9.08; MOD: 93 H;280; NL	<b>AVX 13 x 1750 TM</b>
				AC-C	UNTIL CHA-NO.: 4301979; MTR-CODE: DSC 9.02;DSC 9.08; MOD: 93 T;280; NL	<b>AVX 13 x 1750 TM</b>
				AC-C	UNTIL CHA-NO.: 4301979; MTR-CODE: DSC 9.02;DSC 9.08; MOD: T 93 H;280; NL	<b>AVX 13 x 1750 TM</b>
				ALT	FROM CHA-NO.: 1150612; MTR-CODE: DSC 9.02;DSC 9.08; MOD: 93 H;280; S	<b>AVX 13 x 1725</b>
				ALT	FROM CHA-NO.: 1150612; MTR-CODE: DSC 9.02;DSC 9.08; MOD: 93 T;280; S	<b>AVX 13 x 1725</b>
				ALT	FROM CHA-NO.: 1150612; MTR-CODE: DSC 9.02;DSC 9.08; MOD: T 93 H;280; S	<b>AVX 13 x 1725</b>
				ALT	FROM CHA-NO.: 4301980; MTR-CODE: DSC 9.02;DSC 9.08; MOD: 93 H;280; NL	<b>AVX 13 x 1725</b>
				ALT	FROM CHA-NO.: 4301980; MTR-CODE: DSC 9.02;DSC 9.08; MOD: 93 T;280; NL	<b>AVX 13 x 1725</b>
				ALT	FROM CHA-NO.: 4301980; MTR-CODE: DSC 9.02;DSC 9.08; MOD: T 93 H;280; NL	<b>AVX 13 x 1725</b>
				ALT	MOD: T 93 H;280; REQ: 2	<b>AVX 13 x 1825 TM</b>
				ALT	MTR-CODE: DSC 9.02;DSC 9.08; MOD: 93 H;280; REQ: 2	<b>AVX 13 x 1825 TM</b>
				ALT	MTR-CODE: DSC 9.02;DSC 9.08; MOD: 93 T;280; REQ: 2	<b>AVX 13 x 1825 TM</b>
				ALT	UNTIL CHA-NO.: 1150611; MTR-CODE: DSC 9.02;DSC 9.08; MOD: 93 H;280; S	<b>AVX 13 x 1750 TM</b>
				ALT	UNTIL CHA-NO.: 1150611; MTR-CODE: DSC 9.02;DSC 9.08; MOD: T 93 H;280; S	<b>AVX 13 x 1750 TM</b>

#### 93.M/210

8475 ccm	155 kW	DS 9.08	03.88 - 12.91	AC-C	UNTIL CHA-NO.: 4301979; MTR-CODE: DS 9.08; MOD: 93 M;210; NL	<b>AVX 13 x 1750 TM</b>
				ALT	FROM CHA-NO.: 1150612; MTR-CODE: DS 9.08; MOD: 93 M;210; S	<b>AVX 13 x 1725</b>
				ALT	FROM CHA-NO.: 4301980; MTR-CODE: DS 9.08; MOD: 93 M;210; NL	<b>AVX 13 x 1725</b>
				ALT	MOD: 93 M;210; REQ: 2	<b>AVX 13 x 1825 TM</b>
				ALT	UNTIL CHA-NO.: 1150611; MTR-CODE: DS 9.08; MOD: 93 M;210; S	<b>AVX 13 x 1750 TM</b>

#### 93.M/220

8475 ccm	162 kW	DSC 9.10	12.91 - 12.96	AC-C	UNTIL CHA-NO.: 4301979; MTR-CODE: DSC 9.10; MOD: 93 M;220; NL	<b>AVX 13 x 1750 TM</b>
				ALT	FROM CHA-NO.: 1150612; MTR-CODE: DSC 9.10; MOD: 93 M;220; S	<b>AVX 13 x 1725</b>
				ALT	FROM CHA-NO.: 4301980; MTR-CODE: DSC 9.10; MOD: 93 M;220; NL	<b>AVX 13 x 1725</b>
				ALT	MOD: 93 M;220; REQ: 2	<b>AVX 13 x 1825 TM</b>
				ALT	UNTIL CHA-NO.: 1150611; MTR-CODE: DSC 9.10; MOD: 93 M;220; S	<b>AVX 13 x 1750 TM</b>

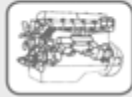

## SCANIA

### Serie 3

#### 93.M/230

8475 ccm	167 kW	DS 9.06	03.88 - 12.91	AC-C	UNTIL CHA-NO.: 4301979; MTR-CODE: DS 9.06; MOD: 93 M;230; NL	AVX 13 x 1750 TM
				ALT	FROM CHA-NO.: 1150612; MTR-CODE: DS 9.06; MOD: 93 M;230; S	AVX 13 x 1725
				ALT	FROM CHA-NO.: 4301980; MTR-CODE: DS 9.06; MOD: 93 M;230; NL	AVX 13 x 1725
				ALT	MOD: 93 M;230; REQ: 2	AVX 13 x 1825 TM
				ALT	UNTIL CHA-NO.: 1150611; MTR-CODE: DS 9.06; MOD: 93 M;230; S	AVX 13 x 1750 TM

### Serie 4

#### 114.C/340

10600 ccm	250 kW	DC 11.01;DC 11.03	09.95 - 09.04	ALT	MOD: 114C;340; - AC	8 PK 1540 TM
				ALT	MOD: 114C;340; + AC	8 PK 1985 TM
				ALT	MOD: T114C/310; - AC	8 PK 1540 TM
				ALT	MOD: T114C/310; + AC	8 PK 1985 TM
				ALT	MOD: T114C/340; - AC	8 PK 1540 TM
				ALT	MOD: T114C/340; + AC	8 PK 1985 TM

#### 114.C/380

10600 ccm	280 kW	DC 11.02	09.95 - 09.04	ALT	MOD: 114C;380; - AC	8 PK 1540 TM
				ALT	MOD: 114C;380; + AC	8 PK 1985 TM
				ALT	MOD: T114C/380; - AC	8 PK 1540 TM
				ALT	MOD: T114C/380; + AC	8 PK 1985 TM
				ALT	MTR-CODE: DC11.01;DC11.03; MOD: T114C/340; - AC	8 PK 1540 TM
				ALT	MTR-CODE: DC11.01;DC11.03; MOD: T114C/340; + AC	8 PK 1985 TM
		DC 11.02;DC 11.04		ALT	MTR-CODE: DC11.02; MOD: 114C;380; - AC	8 PK 1540 TM
				ALT	MTR-CODE: DC11.02; MOD: 114C;380; + AC	8 PK 1985 TM

#### 114.G/340

10600 ccm	250 kW	DC 11.01;DC 11.03	09.95 - 09.04	ALT	MOD: 113G;340;114G;340; - AC	8 PK 1540 TM
				ALT	MOD: 113G;340;114G;340; + AC	8 PK 1985 TM
				ALT	MOD: T114G/340; - AC	8 PK 1540 TM
				ALT	MOD: T114G/340; + AC	8 PK 1985 TM

#### 114.G/380

10600 ccm	280 kW	DC 11.02	09.95 - 09.04	ALT	MOD: 114;G380;114G;380; - AC	8 PK 1540 TM
				ALT	MOD: 114;G380;114G;380; + AC	8 PK 1985 TM
				ALT	MOD: T114G/380; - AC	8 PK 1540 TM
				ALT	MOD: T114G/380; + AC	8 PK 1985 TM

#### 114.L/340

10600 ccm	250 kW	DC 11.01;DC 11.03	09.95 - 09.04	ALT	MOD: 114L340; - AC	8 PK 1540 TM
				ALT	MOD: 114L340; + AC	8 PK 1985 TM
				ALT	MOD: T114L/340; - AC	8 PK 1540 TM
				ALT	MOD: T114L/340; + AC	8 PK 1985 TM

#### 114.L/380

10600 ccm	280 kW	DC 11.02	09.95 - 09.04	ALT	MOD: T114L/380; - AC	8 PK 1540 TM
				ALT	MOD: T114L/380; + AC	8 PK 1985 TM
		DC 11.02;DC 11.04		ALT	MOD: 114L;380; - AC	8 PK 1540 TM
				ALT	MOD: 114L;380; + AC	8 PK 1985 TM

#### 124.C/360

11700 ccm	265 kW	DSC 12.02	09.95 - 09.04	ALT	FROM MTR-NO: 5705225; MOD: 124C;360; - AC	8 PK 1540 TM
				ALT	FROM MTR-NO: 5705225; MOD: 124C;360; + AC	8 PK 1985 TM
				ALT	FROM MTR-NO: 5705225; MOD: 124L;360; - AC	8 PK 1540 TM
				ALT	FROM MTR-NO: 5705225; MOD: 124L;360; + AC	8 PK 1985 TM
				ALT	FROM MTR-NO: 5705225; MOD: T124C/360; - AC	8 PK 1540 TM
				ALT	FROM MTR-NO: 5705225; MOD: T124C/360; + AC	8 PK 1985 TM
				ALT	UNTIL MTR-NO: 5705224; MOD: 124C;360; - AC	8 PK 1515 TM
				ALT	UNTIL MTR-NO: 5705224; MOD: 124C;360; + AC	8 PK 2130 TM
				ALT	UNTIL MTR-NO: 5705224; MOD: 124L;360; - AC	8 PK 1515 TM
				ALT	UNTIL MTR-NO: 5705224; MOD: 124L;360; + AC	8 PK 2130 TM
				ALT	UNTIL MTR-NO: 5705224; MOD: T124C/360; - AC	8 PK 1515 TM
				ALT	UNTIL MTR-NO: 5705224; MOD: T124C/360; + AC	8 PK 2130 TM
				ALT	- AC	KT 7007



## SCANIA

### Serie 4

#### 124.C/400

11700 ccm	294 kW	DSC 12.01	05.96 -	ALT	FROM MTR-NO: 5705225; MOD: 124C;400; - AC	8 PK 1540 TM
				ALT	FROM MTR-NO: 5705225; MOD: 124C;400; + AC	8 PK 1985 TM
				ALT	UNTIL MTR-NO: 5705224; MOD: 124C;400; - AC	8 PK 1515 TM
				ALT	UNTIL MTR-NO: 5705224; MOD: 124C;400; + AC	8 PK 2130 TM
				ALT	- AC	KT 7007

#### 124.C/420

11700 ccm	309 kW	DC 12.01;DSC 12.05	09.95 - 09.04	ALT	FROM MTR-NO: 5705225; MOD: T124/C420/T124C; - AC	8 PK 1540 TM
				ALT	FROM MTR-NO: 5705225; MOD: T124/C420/T124C; + AC	8 PK 1985 TM
				ALT	UNTIL MTR-NO: 5705224; MOD: T124/C420/T124C; - AC	8 PK 1515 TM
				ALT	UNTIL MTR-NO: 5705224; MOD: T124/C420/T124C; + AC	8 PK 2130 TM

#### 124.G/360

11700 ccm	265 kW	DSC 12.02	05.96 -	ALT	FROM MTR-NO: 5705225; MOD: 124G;360; - AC	8 PK 1540 TM
				ALT	FROM MTR-NO: 5705225; MOD: 124G;360; + AC	8 PK 1985 TM
				ALT	FROM MTR-NO: 5705225; MOD: T124G/360; - AC	8 PK 1540 TM
				ALT	FROM MTR-NO: 5705225; MOD: T124G/360; + AC	8 PK 1985 TM
				ALT	UNTIL MTR-NO: 5705224; MOD: 124G;360; - AC	8 PK 1515 TM
				ALT	UNTIL MTR-NO: 5705224; MOD: 124G;360; + AC	8 PK 2130 TM
				ALT	UNTIL MTR-NO: 5705224; MOD: T124G/360; - AC	8 PK 1515 TM
				ALT	UNTIL MTR-NO: 5705224; MOD: T124G/360; + AC	8 PK 2130 TM
				ALT	- AC	KT 7007

#### 124.G/400

11700 ccm	294 kW	DSC 12.01	05.96 -	ALT	FROM MTR-NO: 5705225; MOD: 124G;400; - AC	8 PK 1540 TM
				ALT	FROM MTR-NO: 5705225; MOD: 124G;400; + AC	8 PK 1985 TM
				ALT	FROM MTR-NO: 5705225; MOD: T124G/400; - AC	8 PK 1540 TM
				ALT	FROM MTR-NO: 5705225; MOD: T124G/400; + AC	8 PK 1985 TM
				ALT	UNTIL MTR-NO: 5705224; MOD: 124G;400; - AC	8 PK 1515 TM
				ALT	UNTIL MTR-NO: 5705224; MOD: 124G;400; + AC	8 PK 2130 TM
				ALT	UNTIL MTR-NO: 5705224; MOD: T124G/400; - AC	8 PK 1515 TM
				ALT	UNTIL MTR-NO: 5705224; MOD: T124G/400; + AC	8 PK 2130 TM
				ALT	- AC	KT 7007

#### 124.G/420

11700 ccm	309 kW	DC 12.01;DSC 12.05	09.95 - 09.04	ALT	- AC	KT 7007
-----------	--------	--------------------	---------------	-----	------	---------

#### 124.L/360

11700 ccm	265 kW	DSC 12.02	05.95 -	ALT	- AC	KT 7007
-----------	--------	-----------	---------	-----	------	---------

#### 124.L/400

11700 ccm	294 kW	DSC 12.01	05.96 -	ALT	- AC	KT 7007
-----------	--------	-----------	---------	-----	------	---------

#### 124.L/420

11716 ccm	308-309 kW	DC 12.01;DC 12.03;DSC 12.05	09.95 - 09.04	ALT	- AC	KT 7007
11700 ccm	309 kW	DC 12.01;DSC 12.05		ALT	- AC	KT 7007
		DSC 12.05		ALT	- AC	KT 7007

#### 124.L/470

11716 ccm	345 kW	DT 12.02	09.95 - 09.04	ALT	- AC	KT 7007
-----------	--------	----------	---------------	-----	------	---------

#### 144.C/460

14200 ccm	338 kW	DSC 14.15	09.95 -	ALT	FROM MTR-NO: 1231229; MOD: 144C;460; + AC	8 PK 2215 TM
				ALT	FROM MTR-NO: 1231229; MOD: T144C/460; + AC	8 PK 2215 TM
				ALT	FROM MTR-NO: 1378052; MOD: 144C;460; + AC	8 PK 2215 TM
				ALT	FROM MTR-NO: 1378052; MOD: T144C/460; + AC	8 PK 2215 TM

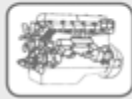

## SCANIA

### Serie 4

#### 144.C/460

14200 ccm	338 kW	DSC 14.15	09.95 -	ALT	FROM MTR-NO: 9024984; MOD: 144C;460; + AC	8 PK 2215 TM
				ALT	FROM MTR-NO: 9024984; MOD: T144C/460; + AC	8 PK 2215 TM
				ALT	MOD: 144C;460; - AC	8 PK 2045 TM
				ALT	MOD: T144C/460; - AC	8 PK 2045 TM
				ALT	UNTIL MTR-NO: 1231228; MOD: 144C;460; + AC	8 PK 2164 TM
				ALT	UNTIL MTR-NO: 1231228; MOD: T144C/460; + AC	8 PK 2164 TM
				ALT	UNTIL MTR-NO: 1378051; MOD: 144C;460; + AC	8 PK 2164 TM
				ALT	UNTIL MTR-NO: 1378051; MOD: T144C/460; + AC	8 PK 2164 TM
				ALT	UNTIL MTR-NO: 9024983; MOD: 144C;460; + AC	8 PK 2164 TM
				ALT	UNTIL MTR-NO: 9024983; MOD: T144C/460; + AC	8 PK 2164 TM

#### 144.C/530

14200 ccm	390 kW	DSC 14.13	09.95 -	ALT	FROM MTR-NO: 1231229; MOD: 144C;530; + AC	8 PK 2215 TM
				ALT	FROM MTR-NO: 1231229; MOD: T144C/530; + AC	8 PK 2215 TM
				ALT	FROM MTR-NO: 1378052; MOD: 144C;530; + AC	8 PK 2215 TM
				ALT	FROM MTR-NO: 1378052; MOD: T144C/530; + AC	8 PK 2215 TM
				ALT	FROM MTR-NO: 9024984; MOD: 144C;530; + AC	8 PK 2215 TM
				ALT	FROM MTR-NO: 9024984; MOD: T144C/530; + AC	8 PK 2215 TM
				ALT	MOD: 144C;530; - AC	8 PK 2045 TM
				ALT	MOD: T144C/530; - AC	8 PK 2045 TM
				ALT	UNTIL MTR-NO: 1231228; MOD: 144C;530; + AC	8 PK 2164 TM
				ALT	UNTIL MTR-NO: 1231228; MOD: T144C/530; + AC	8 PK 2164 TM
				ALT	UNTIL MTR-NO: 1378051; MOD: 144C;530; + AC	8 PK 2164 TM
				ALT	UNTIL MTR-NO: 1378051; MOD: T144C/530; + AC	8 PK 2164 TM
				ALT	UNTIL MTR-NO: 9024983; MOD: 144C;530; + AC	8 PK 2164 TM
				ALT	UNTIL MTR-NO: 9024983; MOD: T144C/530; + AC	8 PK 2164 TM

#### 144.G/460

14200 ccm	338 kW	DSC 14.15	04.96 -	ALT	FROM MTR-NO: 1231229; MOD: 144G;460; + AC	8 PK 2215 TM
				ALT	FROM MTR-NO: 1231229; MOD: T144G/460; + AC	8 PK 2215 TM
				ALT	FROM MTR-NO: 1378052; MOD: 144G;460; + AC	8 PK 2215 TM
				ALT	FROM MTR-NO: 1378052; MOD: T144G/460; + AC	8 PK 2215 TM
				ALT	FROM MTR-NO: 9024984; MOD: 144G;460; + AC	8 PK 2215 TM
				ALT	FROM MTR-NO: 9024984; MOD: T144G/460; + AC	8 PK 2215 TM
				ALT	MOD: 144G;460; - AC	8 PK 2045 TM
				ALT	MOD: T144G/460; - AC	8 PK 2045 TM
				ALT	UNTIL MTR-NO: 1231228; MOD: 144G;460; + AC	8 PK 2164 TM
				ALT	UNTIL MTR-NO: 1231228; MOD: T144G/460; + AC	8 PK 2164 TM
				ALT	UNTIL MTR-NO: 1378051; MOD: 144G;460; + AC	8 PK 2164 TM
				ALT	UNTIL MTR-NO: 1378051; MOD: T144G/460; + AC	8 PK 2164 TM
				ALT	UNTIL MTR-NO: 9024983; MOD: 144G;460; + AC	8 PK 2164 TM
				ALT	UNTIL MTR-NO: 9024983; MOD: T144G/460; + AC	8 PK 2164 TM



## SCANIA

### Serie 4

#### 144.G/530

14200 ccm	390 kW	DSC 14.13	04.96 -	ALT	FROM MTR-NO: 1231229; MOD: 144G;530; + AC	8 PK 2215 TM
				ALT	FROM MTR-NO: 1231229; MOD: T144G/530; + AC	8 PK 2215 TM
				ALT	FROM MTR-NO: 1378052; MOD: 144G;530; + AC	8 PK 2215 TM
				ALT	FROM MTR-NO: 1378052; MOD: T144G/530; + AC	8 PK 2215 TM
				ALT	FROM MTR-NO: 9024984; MOD: 144G;530; + AC	8 PK 2215 TM
				ALT	FROM MTR-NO: 9024984; MOD: T144G/530; + AC	8 PK 2215 TM
				ALT	MOD: 144G;530; - AC	8 PK 2045 TM
				ALT	MOD: T144G/530; - AC	8 PK 2045 TM
				ALT	UNTIL MTR-NO: 1231228; MOD: 144G;530	8 PK 2164 TM
				ALT	UNTIL MTR-NO: 1231228; MOD: T144G/530; + AC	8 PK 2164 TM
				ALT	UNTIL MTR-NO: 1378051; MOD: 144G;530; + AC	8 PK 2164 TM
				ALT	UNTIL MTR-NO: 1378051; MOD: T144G/530; + AC	8 PK 2164 TM
				ALT	UNTIL MTR-NO: 9024983; MOD: 144G;530; + AC	8 PK 2164 TM
				ALT	UNTIL MTR-NO: 9024983; MOD: T144G/530; + AC	8 PK 2164 TM

#### 144.L/460

14200 ccm	338 kW	DSC 14.15	09.95 - 09.04	ALT	FROM MTR-NO: 1231229; MOD: 144L;460; + AC	8 PK 2215 TM
				ALT	FROM MTR-NO: 1231229; MOD: T144L/460; + AC	8 PK 2215 TM
				ALT	FROM MTR-NO: 1378052; MOD: 144L;460; + AC	8 PK 2215 TM
				ALT	FROM MTR-NO: 1378052; MOD: T144L/460; + AC	8 PK 2215 TM
				ALT	FROM MTR-NO: 9024984; MOD: 144L;460; + AC	8 PK 2215 TM
				ALT	FROM MTR-NO: 9024984; MOD: T144L/460; + AC	8 PK 2215 TM
				ALT	MOD: 144L;460; - AC	8 PK 2045 TM
				ALT	MOD: T144L/460; - AC	8 PK 2045 TM
				ALT	UNTIL MTR-NO: 1231228; MOD: 144L;460; + AC	8 PK 2164 TM
				ALT	UNTIL MTR-NO: 1231228; MOD: T144L/460; + AC	8 PK 2164 TM
				ALT	UNTIL MTR-NO: 1378051; MOD: 144L;460; + AC	8 PK 2164 TM
				ALT	UNTIL MTR-NO: 1378051; MOD: T144L/460; + AC	8 PK 2164 TM
				ALT	UNTIL MTR-NO: 9024983; MOD: 144L;460; + AC	8 PK 2164 TM
				ALT	UNTIL MTR-NO: 9024983; MOD: T144L/460; + AC	8 PK 2164 TM

#### 144.L/530

14200 ccm	390 kW	DSC 14.13	09.95 - 09.04	ALT	FROM MTR-NO: 1231229; MOD: 144L;530; + AC	8 PK 2215 TM
				ALT	FROM MTR-NO: 1231229; MOD: T144L/530; + AC	8 PK 2215 TM
				ALT	FROM MTR-NO: 1378052; MOD: 144L;530; + AC	8 PK 2215 TM
				ALT	FROM MTR-NO: 1378052; MOD: T144L/530; + AC	8 PK 2215 TM
				ALT	FROM MTR-NO: 9024984; MOD: 144L;530; + AC	8 PK 2215 TM
				ALT	FROM MTR-NO: 9024984; MOD: T144L/530; + AC	8 PK 2215 TM
				ALT	MOD: 144L;530; - AC	8 PK 2045 TM
				ALT	MOD: T144L/530; - AC	8 PK 2045 TM
				ALT	UNTIL MTR-NO: 1231228; MOD: 144L;530; + AC	8 PK 2164 TM
				ALT	UNTIL MTR-NO: 1231228; MOD: T144L/530; + AC	8 PK 2164 TM
				ALT	UNTIL MTR-NO: 1378051; MOD: 144L;530; + AC	8 PK 2164 TM
				ALT	UNTIL MTR-NO: 1378051; MOD: T144L/530; + AC	8 PK 2164 TM
				ALT	UNTIL MTR-NO: 9024983; MOD: 144L;530; + AC	8 PK 2164 TM
				ALT	UNTIL MTR-NO: 9024983; MOD: T144L/530; + AC	8 PK 2164 TM

#### 164.C/480

15600 ccm	353 kW	DC 16.02	05.00 -	ALT	MOD: 164C;480; - AC	8 PK 1795 TM
				ALT	MOD: 164C;480; + AC	8 PK 2080 TM
				FAN	MOD: 164C;480	8 PK 1255 TM

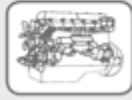

## SCANIA

### Serie 4

#### 164.C/580

15600 ccm	426 kW	DC 16.01	05.00 -	ALT	MOD: 164C;580; - AC	8 PK 1795 TM
				ALT	MOD: 164C;580; + AC	8 PK 2080 TM
				FAN	MOD: 164C;580	8 PK 1255 TM

#### 164.G/480

15600 ccm	353 kW	DC 16.02	09.95 - 09.04	ALT	MOD: 164G;480; - AC	8 PK 1795 TM
				ALT	MOD: 164G;480; + AC	8 PK 2080 TM
				FAN	MOD: 164G;480	8 PK 1255 TM

#### 164.G/580

15600 ccm	426 kW	DC 16.01	09.95 - 09.04	ALT	MOD: 164G;580; - AC	8 PK 1795 TM
				ALT	MOD: 164G;580; + AC	8 PK 2080 TM
				FAN	MOD: 164G;580	8 PK 1255 TM

#### 164.L/480

15600 ccm	353 kW	DC 16.02	09.95 - 09.04	ALT	MOD: 164L;480; - AC	8 PK 1795 TM
				ALT	MOD: 164L;480; + AC	8 PK 2080 TM
				FAN	MOD: 164L;480	8 PK 1255 TM

#### 164.L/580

15600 ccm	426 kW	DC 16.01	09.95 - 09.04	ALT	MOD: 164L;580; - AC	8 PK 1795 TM
				ALT	MOD: 164L;580; + AC	8 PK 2080 TM
				FAN	MOD: 164L;580	8 PK 1255 TM

#### 94.C/260

9000 ccm	191 kW	DC 9.02;DSC 9.12	12.96 -	ALT	AMP: 90; MOD: 94 C;260; - AC	AVX 13 x 1625 TM
				ALT	MOD: 94 C;260; REQ: 2; - AC	AVX 13 x 1700 TM
				ALT	MOD: 94 C;260; REQ: 2; + AC	AVX 13 x 1900 TM
		DSC 9.12		ALT	AMP: 90; MOD: 94 C;260; - AC	AVX 13 x 1625 TM
				ALT	MOD: 94 C;260; REQ: 2; - AC	AVX 13 x 1700 TM
				ALT	MOD: 94 C;260; REQ: 2; + AC	AVX 13 x 1900 TM

#### 94.C/310

9000 ccm	228 kW	DSC 9.13;DSC 9.15	08.96 -	ALT	MTR-CODE: DSC 9.13;DSC 9.13;DSC 9.15; AMP: 90; MOD: 94 C;310; - AC	AVX 13 x 1625 TM
				ALT	MTR-CODE: DSC 9.13;DSC 9.13;DSC 9.15; MOD: 94 C;310; REQ: 2; - AC	AVX 13 x 1700 TM
				ALT	MTR-CODE: DSC 9.13;DSC 9.13;DSC 9.15; MOD: 94 C;310; REQ: 2; + AC	AVX 13 x 1900 TM

#### 94.D/220

9000 ccm	162 kW	DSC 9.11	09.95 - 09.04	ALT	AMP: 90; MOD: 94 D;220; - AC	AVX 13 x 1625 TM
				ALT	MOD: 94 D;220; REQ: 2; - AC	AVX 13 x 1700 TM
				ALT	MOD: 94 D;220; REQ: 2; + AC	AVX 13 x 1900 TM

#### 94.D/260

9000 ccm	191 kW	DC 9.02;DSC 9.12	09.95 - 09.04	ALT	AMP: 90; MOD: 94 D;260; - AC	AVX 13 x 1625 TM
				ALT	MOD: 94 D;260; REQ: 2; - AC	AVX 13 x 1700 TM
				ALT	MOD: 94 D;260; REQ: 2; + AC	AVX 13 x 1900 TM
		DSC 9.12		ALT	AMP: 90; MOD: 94 D;260; - AC	AVX 13 x 1625 TM
				ALT	MOD: 94 D;260; REQ: 2; - AC	AVX 13 x 1700 TM
				ALT	MOD: 94 D;260; REQ: 2; + AC	AVX 13 x 1900 TM

#### 94.D/310

9000 ccm	228 kW	DSC 9.13;DSC 9.15	09.95 - 09.04	ALT	MTR-CODE: DSC 9.13;DSC 9.13;DSC 9.15; AMP: 90; MOD: 94 D;310; - AC	AVX 13 x 1625 TM
				ALT	MTR-CODE: DSC 9.13;DSC 9.13;DSC 9.15; MOD: 94 D;310; REQ: 2; - AC	AVX 13 x 1700 TM
				ALT	MTR-CODE: DSC 9.13;DSC 9.13;DSC 9.15; MOD: 94 D;310; REQ: 2; + AC	AVX 13 x 1900 TM

#### 94.G/220

9000 ccm	162 kW	DSC 9.11	08.96 -	ALT	AMP: 90; MOD: 94 G;220; - AC	AVX 13 x 1625 TM
				ALT	MOD: 94 G;220; REQ: 2; - AC	AVX 13 x 1700 TM
				ALT	MOD: 94 G;220; REQ: 2; + AC	AVX 13 x 1900 TM

#### 94.G/260

9000 ccm	191 kW	DSC 9.12	09.95 - 09.04	ALT	AMP: 90; MOD: 94 G;260; - AC	AVX 13 x 1625 TM
				ALT	MOD: 94 G;260; REQ: 2; - AC	AVX 13 x 1700 TM
				ALT	MOD: 94 G;260; REQ: 2; + AC	AVX 13 x 1900 TM

#### 94.G/310

9000 ccm	228 kW	DSC 9.13;DSC 9.15	09.95 - 09.04	ALT	MTR-CODE: DSC 9.13;DSC 9.13;DSC 9.15; AMP: 90; MOD: 94 G;310; - AC	AVX 13 x 1625 TM
				ALT	MTR-CODE: DSC 9.13;DSC 9.13;DSC 9.15; MOD: 94 G;310; REQ: 2; - AC	AVX 13 x 1700 TM
				ALT	MTR-CODE: DSC 9.13;DSC 9.13;DSC 9.15; MOD: 94 G;310; REQ: 2; + AC	AVX 13 x 1900 TM



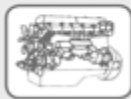

## SCANIA

### Serie 4

#### 94.L/310

9000 ccm	228 kW	DSC 9.13;DSC 9.15	09.95 - 09.04	ALT	MTR-CODE: DSC 9.13;DSC 9.13;DSC 9.15; AMP: 90; MOD: 94 L;310; - AC	AVX 13 x 1625 TM
				ALT	MTR-CODE: DSC 9.13;DSC 9.13;DSC 9.15; MOD: 94 L;310; REQ: 2; - AC	AVX 13 x 1700 TM
				ALT	MTR-CODE: DSC 9.13;DSC 9.13;DSC 9.15; MOD: 94 L;310; REQ: 2; + AC	AVX 13 x 1900 TM

### Serie P,G,R,T

#### 270

8867 ccm	198-199 kW	DC 9.12	03.04 -	ALT	MOD: P270; - AC	8 PK 2000 TM
				ALT	MOD: P270; + AC	8 PK 2114 TM
				ALT	MOD: R270; - AC	8 PK 2000 TM
				ALT	MOD: R270; + AC	8 PK 2114 TM

#### 340

10600 ccm	250 kW	DC 11.08	03.04 -	AC-C	MTR-CODE: DC11.08; MOD: R;R 340; + AC	8 PK 2114 TM
				ALT	MOD: R340; - AC	8 PK 2000 TM

#### 380

10600 ccm	279 kW	DC 11.09	03.04 -	AC-C	MTR-CODE: DC11.09; MOD: R;R 380; + AC	8 PK 2114 TM
				ALT	MOD: P380; - AC	8 PK 2000 TM
				ALT	MOD: R380; - AC	8 PK 2000 TM
				ALT	MTR-CODE: DC11.09; MOD: P380; + AC	8 PK 2114 TM

#### 420

11716 ccm	309 kW	DC 12.14;DC 12.15;DT 12.11;DT 12.12	03.04 -	ALT	MTR-CODE: DC 12.14;DT 12.11; MOD: R;R 420; + AC-AUTO	8 PK 2114 TM
				ALT	MTR-CODE: DC12.14/DT12.11; MOD: R420; + AC	8 PK 2114 TM
				ALT	MTR-CODE: DC12.14;DT12.11; MOD: R420; - AC	8 PK 2000 TM

#### 470

11716 ccm	345 kW	DT 12.03;DT 12.06	03.04 -	ALT	MTR-CODE: DT12.06; MOD: R470; - AC	8 PK 2000 TM
				ALT	MTR-CODE: DT12.06; MOD: R470; + AC	8 PK 2114 TM

#### 500

15600 ccm	368 kW	DC 16.04;DC 16.19	03.04 -	ALT	MTR-CODE: DC16.04; MOD: R500; - AC	8 PK 1795 TM
				ALT	MTR-CODE: DC16.04; MOD: R500; + AC	8 PK 2080 TM
				FAN	MTR-CODE: DC16.04; MOD: R500	8 PK 1255 TM

#### 580

15600 ccm	426 kW	DC 16.03	03.04 -	ALT	MOD: R580; - AC	8 PK 1795 TM
				ALT	MOD: R580; + AC	8 PK 2080 TM
				FAN	MOD: R580	8 PK 1255 TM

## VOLVO

### FH 12

#### 12/340

12100 ccm	250 kW	D12A340;D12C340;D12D340	08.93 -	ALT	MTR-CODE: D12C340;D12D340; MOD: FH12/340; - AC	8 PK 830 TM
				ALT	MTR-CODE: D12C340;D12D340; MOD: FH12/340; + AC	8 PK 975 TM
				FAN	MTR-CODE: D12C340;D12D340; MOD: FH12/340; + EXT-COOL	10 PK 1145 TM
				FAN	MTR-CODE: D12C340;D12D340; MOD: FH12/340; + STD-COOL	10 PK 1108 TM
				AC-C		KT 7001

#### 12/380

12100 ccm	279 kW	D12A380;D12C380;D12D380	08.93 -	ALT	MTR-CODE: D12C380;D12D380; MOD: FH12/380; - AC	8 PK 830 TM
	279-280 kW			ALT	MTR-CODE: D12C380;D12D380; MOD: FH12/380; - AC	8 PK 830 TM
	279 kW			ALT	MTR-CODE: D12C380;D12D380; MOD: FH12/380; + AC	8 PK 975 TM
	279-280 kW			ALT	MTR-CODE: D12C380;D12D380; MOD: FH12/380; + AC	8 PK 975 TM
	279 kW			ALT	MTR-CODE: D12C460;D12D460; MOD: FH12/460; - AC	8 PK 830 TM
	279-280 kW			ALT	MTR-CODE: D12C460;D12D460; MOD: FH12/460; - AC	8 PK 830 TM
				ALT	MTR-CODE: D12C460;D12D460; MOD: FH12/460; + AC	8 PK 975 TM
	279 kW			ALT	MTR-CODE: D12C460;D12D460; MOD: FH12/460; + AC	8 PK 975 TM

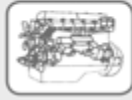

## VOLVO

### FH 12

12/380						
12100 ccm	279-280 kW	D12A380;D12C380;D12D380	08.93 -	FAN	MTR-CODE: D12C380;D12D380; MOD: FH12/380; + EXT-COOL	10 PK 1145 TM
	279 kW			FAN	MTR-CODE: D12C380;D12D380; MOD: FH12/380; + EXT-COOL	10 PK 1145 TM
				FAN	MTR-CODE: D12C380;D12D380; MOD: FH12/380; + STD-COOL	10 PK 1108 TM
	279-280 kW			FAN	MTR-CODE: D12C380;D12D380; MOD: FH12/380; + STD-COOL	10 PK 1108 TM
	279 kW			FAN	MTR-CODE: D12C460;D12D460; MOD: FH12/460; + EXT-COOL	10 PK 1145 TM
	279-280 kW			FAN	MTR-CODE: D12C460;D12D460; MOD: FH12/460; + EXT-COOL	10 PK 1145 TM
	279 kW			FAN	MTR-CODE: D12C460;D12D460; MOD: FH12/460; + STD-COOL	10 PK 1108 TM
	279-280 kW			FAN	MTR-CODE: D12C460;D12D460; MOD: FH12/460; + STD-COOL	10 PK 1108 TM
	279 kW			AC-C		KT 7001

12/420						
12100 ccm	309 kW	D12A420;D12C420;D12D420	08.93 -	ALT	MTR-CODE: D12C420;D12D420; MOD: FH12/420; - AC	8 PK 830 TM
				ALT	MTR-CODE: D12C420;D12D420; MOD: FH12/420; + AC	8 PK 975 TM
				FAN	MTR-CODE: D12C420;D12D420; MOD: FH12/420	10 PK 1108 TM
				AC-C		KT 7001

### FH 16

16/470						
16120 ccm	346 kW	D16A470	08.93 - 12.99	ALT	OE-NO.: 977832; MOD: FH16/470	8 PK 1055 TM
				ALT	OE-NO.: 977832; MOD: FH16/470; + AC	8 PK 1055 TM
				ALT	OE-NO.: 977836; MOD: FH16/470; + AC	8 PK 1075 TM
				FAN	MOD: FH16/470; Ø-P: 192;3	8 PK 1075 TM

### FL 6

608						
5480 ccm	108-112 kW	TD 61 G;TD 61 GA	10.85 - 12.99	AC-C	UNTIL: 09.98; MOD: FL 608	AVX 13 x 1225 TM
				ALT		AVX 10 x 1125
				ALT	+ PTO	AVX 10 x 1175
				ALT	AMP: 80	AVX 10 x 1175
				ALT	AMP: 80; REQ: 2	AVX 10 x 1200
	126-132 kW	D6A180;TD 63 E		AIR-C	UNTIL: 09.98; MTR-CODE: D6A180;D6A180;TD 63 E; MOD: FL 608	AVX 13 x 1050 TM
				ALT		AVX 10 x 1125
				ALT	+ PTO	AVX 10 x 1175
				ALT	AMP: 80	AVX 10 x 1175
				ALT	AMP: 80; REQ: 2	AVX 10 x 1200
				HYD-P	UNTIL: 09.98; MOD: FL 608	AVX 13 x 1350 TM
				W-P	UNTIL: 09.98; MTR-CODE: D6A180;TD 63 E;TD63E; MOD: FL 608	AVX 13 x 1225 TM
	154 kW	D6A210;TD 63 ES		AC-C	UNTIL: 09.98; MTR-CODE: D6A210;TD 63 ES;TD63ES; MOD: FL 608	AVX 13 x 1225 TM
				AIR-C	UNTIL: 09.98; MTR-CODE: D6A210;D6A210;TD 63 ES; MOD: FL 608	AVX 13 x 1050 TM
				ALT		AVX 10 x 1125
				ALT	+ PTO	AVX 10 x 1175
				ALT	AMP: 80	AVX 10 x 1175
				ALT	AMP: 80; REQ: 2	AVX 10 x 1200

611						
5480 ccm	108-112 kW	TD 61 G;TD 61 GA	09.85 - 03.00	AC-C	MOD: FL 611	AVX 13 x 1225 TM
				ALT		AVX 10 x 1125
				ALT	+ PTO	AVX 10 x 1175
				ALT	AMP: 80	AVX 10 x 1175
				ALT	AMP: 80; REQ: 2	AVX 10 x 1200
	126-132 kW	D6A180;TD 61 GB;TD 61 GC;TD 61 GS;TD 63 E		ALT		AVX 10 x 1125
				ALT	+ PTO	AVX 10 x 1175
				ALT	AMP: 80	AVX 10 x 1175
				ALT	AMP: 80; REQ: 2	AVX 10 x 1200
	154 kW	D6A210;TD 63 ES		AC-C	UNTIL: 09.98; MTR-CODE: D6A210;TD 63 ES;TD63ES; MOD: FL 611	AVX 13 x 1225 TM

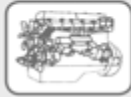

## VOLVO

### FL 6

#### 611

5480 ccm	154 kW	D6A210;TD 63 ES	09.85 - 03.00	AIR-C	UNTIL: 09.98; MTR-CODE: D6A210;D6A210;TD 63 ES; MOD: FL 611	AVX 13 x 1050 TM
				ALT		AVX 10 x 1125
				ALT	+ PTO	AVX 10 x 1175
				ALT	AMP: 80	AVX 10 x 1175
				ALT	AMP: 80; REQ: 2	AVX 10 x 1200

#### 612

5480 ccm	154 kW	D6A210;TD 63 ES	09.85 - 12.99	AC-C	UNTIL: 09.98; MTR-CODE: D6A210;TD 63 ES;TD63ES; MOD: FL 612	AVX 13 x 1225 TM
				AIR-C	UNTIL: 09.98; MTR-CODE: D6A210;D6A210;TD 63 ES; MOD: FL 612	AVX 13 x 1050 TM
	169 kW	D6A230		AC-C	UNTIL: 09.98; MOD: FL 612	AVX 13 x 1050 TM
	184 kW	D6A250		AC-C	UNTIL: 09.98; MOD: FL 612; REQ: 2	AVX 13 x 1050 TM
					MOD: FL612	8 PK 1560 TM

#### 614

5480 ccm	132 kW	D6A180	09.85 - 03.00	AC-C	UNTIL: 09.98; MOD: FL 614	AVX 13 x 1050 TM
	150-154 kW	D6A210;TD 61 F;TD 63 ES		AC-C	UNTIL: 09.98; MTR-CODE: D6A210;D6A210;TD 61 F; MOD: FL 614	AVX 13 x 1050 TM
				ALT	UNTIL: 09.98; MTR-CODE: D6A210;TD 61 F;TD63ES; MOD: FL 614	AVX 13 x 1225 TM
	169 kW	D6A230		AC-C	UNTIL: 09.98; MOD: FL 614	AVX 13 x 1050 TM
	184 kW	D6A250		AC-C	UNTIL: 09.98; MOD: FL 614; REQ: 2	AVX 13 x 1050 TM
					MOD: FL614	8 PK 1560 TM

#### 615

5480 ccm	154 kW	D6A210;TD 63 ES	11.91 - 03.00	AC-C	UNTIL: 09.98; MTR-CODE: D6A210;D6A210;TD 63 ES; MOD: FL 615	AVX 13 x 1050 TM
				ALT	UNTIL: 09.98; MTR-CODE: D6A210;TD 63 ES;TD63ES; MOD: FL 615	AVX 13 x 1225 TM
	169 kW	D6A230		AC-C	UNTIL: 09.98; MOD: FL 615	AVX 13 x 1050 TM
	184 kW	D6A250		AC-C	UNTIL: 09.98; MOD: FL 615; REQ: 2	AVX 13 x 1050 TM
					MOD: FL615	8 PK 1560 TM

#### 618

5480 ccm	154 kW	D6A210;TD 63 ES	11.91 - 03.00	AC-C	UNTIL: 09.98; MTR-CODE: D6A210;D6A210;TD 63 ES; MOD: FL 618	AVX 13 x 1050 TM
				ALT	UNTIL: 09.98; MTR-CODE: D6A210;TD 63 ES;TD63ES; MOD: FL 618	AVX 13 x 1225 TM
	169 kW	D6A230		AC-C	UNTIL: 09.98; MOD: FL 618	AVX 13 x 1050 TM
	184 kW	D6A250		AC-C	UNTIL: 09.98; MOD: FL 618; REQ: 2	AVX 13 x 1050 TM
					MOD: FL618	8 PK 1560 TM

### FL 10

#### 10/280

9600 ccm	202-209 kW	TD 101 G	09.85 - 12.90	AC-C	MOD: FL 10;280; 1 ALT	AVX 13 x 1050 TM
				AC-C	MTR-CODE: TD 101 G; MOD: FL 10;280; 2 ALT	AVX 13 x 1175 TM
				FAN	MTR-CODE: TD 101 G; MOD: FL 10;280; REQ: 2; - INT-COOL; + EXT-COOL	AVX 13 x 1175 TM
				FAN	MTR-CODE: TD 101 G; MOD: FL 10;280; REQ: 2; - INT-COOL; + STD-COOL	AVX 13 x 1175 TM
				FAN	MTR-CODE: TD 101 G; MOD: FL 10;280; REQ: 2; + EXT-COOL	AVX 13 x 1150 TM
				FAN	MTR-CODE: TD 101 G; MOD: FL 10;280; REQ: 2; + INT-COOL	AVX 13 x 1150 TM
				HYD-P	MTR-CODE: TD 101 G; MOD: FL 10;280; REQ: 2	AVX 13 x 1175 TM

#### 10H/320

9600 ccm	235 kW	D10A320	12.95 - 09.98	AC-C	MOD: FL 10H;320; 1 ALT	AVX 13 x 1050 TM
				AC-C	MTR-CODE: D10A320; MOD: FL 10H;320; 2 ALT	AVX 13 x 1175 TM
				FAN	MOD: FL 10H;320; REQ: 2; + EXT-COOL	AVX 13 x 1200 TM
				HYD-P	MTR-CODE: D10A320; MOD: FL 10H;320; REQ: 2	AVX 13 x 1175 TM
				ALT; 1. ALT	MOD: FL10H/320	8 PK 1230 TM

#### 10H/360

9600 ccm	265 kW	D10A360	12.95 - 09.98	AC-C	MOD: FL 10H;360; 1 ALT	AVX 13 x 1050 TM
				AC-C	MTR-CODE: D10A360; MOD: FL 10H;360; 2 ALT	AVX 13 x 1175 TM
				FAN	MOD: FL 10H;360; REQ: 2; + EXT-COOL	AVX 13 x 1200 TM
				FAN	MOD: FL 10H;360; REQ: 2; + STD-COOL	AVX 13 x 1150 TM
				HYD-P	MTR-CODE: D10A360; MOD: FL 10H;360; REQ: 2	AVX 13 x 1175 TM
				ALT; 1. ALT	MOD: FL10H/360	8 PK 1230 TM



## VOLVO

### FL 12

#### 12/380

12100 ccm	279 kW	D12A380	09.95 - 09.98	ALT	MOD: FL12/380/FL12H/380; - AC	8 PK 900 TM
				ALT	MOD: FL12/380/FL12H/380; + AC	8 PK 1035 TM
				FAN	MOD: FL12/380/FL12H/380; C-DIM: 767 [mm]; Ø-P: 168;3; + STD-COOL	8 PK 1005 TM
				FAN	MOD: FL12/380/FL12H/380; C-DIM: 767 [mm]; Ø-P: 192;3; + STD-COOL	8 PK 1035 TM
				FAN	MOD: FL12/380/FL12H/380; C-DIM: 767 [mm]; Ø-P: 219;3; + STD-COOL	8 PK 1075 TM
				FAN	MOD: FL12/380/FL12H/380; C-DIM: 926 [mm]; Ø-P: 168;3; + EXT-COOL	8 PK 1020 TM
				FAN	MOD: FL12/380/FL12H/380; C-DIM: 926 [mm]; Ø-P: 192;3; + EXT-COOL	8 PK 1055 TM
				FAN	MOD: FL12/380/FL12H/380; C-DIM: 926 [mm]; Ø-P: 219;3; + EXT-COOL	8 PK 1095 TM

#### 12/420

12100 ccm	309 kW	D12A420	09.95 - 09.98	ALT	MOD: FL12/420/FL12H/420; - AC	8 PK 900 TM
				ALT	MOD: FL12/420/FL12H/420; + AC	8 PK 1035 TM
				FAN	MOD: FL12/420/FL12H/420; C-DIM: 767 [mm]; Ø-P: 168;3; + STD-COOL	8 PK 1005 TM
				FAN	MOD: FL12/420/FL12H/420; C-DIM: 767 [mm]; Ø-P: 192;3; + STD-COOL	8 PK 1035 TM
				FAN	MOD: FL12/420/FL12H/420; C-DIM: 767 [mm]; Ø-P: 219;3; + STD-COOL	8 PK 1075 TM
				FAN	MOD: FL12/420/FL12H/420; C-DIM: 926 [mm]; Ø-P: 168;3; + EXT-COOL	8 PK 1020 TM
				FAN	MOD: FL12/420/FL12H/420; C-DIM: 926 [mm]; Ø-P: 192;3; + EXT-COOL	8 PK 1055 TM
				FAN	MOD: FL12/420/FL12H/420; C-DIM: 926 [mm]; Ø-P: 219;3; + EXT-COOL	8 PK 1095 TM

#### 12H/380

12100 ccm	279 kW	D12A380	09.95 - 09.98	ALT	MOD: FL12/380/FL12H/380; - AC	8 PK 900 TM
				ALT	MOD: FL12/380/FL12H/380; + AC	8 PK 1035 TM
				FAN	MOD: FL12/380/FL12H/380; C-DIM: 767 [mm]; Ø-P: 168;3; + STD-COOL	8 PK 1005 TM
				FAN	MOD: FL12/380/FL12H/380; C-DIM: 767 [mm]; Ø-P: 192;3; + STD-COOL	8 PK 1035 TM
				FAN	MOD: FL12/380/FL12H/380; C-DIM: 767 [mm]; Ø-P: 219;3; + STD-COOL	8 PK 1075 TM
				FAN	MOD: FL12/380/FL12H/380; C-DIM: 926 [mm]; Ø-P: 168;3; + EXT-COOL	8 PK 1020 TM
				FAN	MOD: FL12/380/FL12H/380; C-DIM: 926 [mm]; Ø-P: 192;3; + EXT-COOL	8 PK 1055 TM
				FAN	MOD: FL12/380/FL12H/380; C-DIM: 926 [mm]; Ø-P: 219;3; + EXT-COOL	8 PK 1095 TM

#### 12H/420

12100 ccm	309 kW	D12A420	09.95 - 09.98	ALT	MOD: FL12/420/FL12H/420; - AC	8 PK 900 TM
				ALT	MOD: FL12/420/FL12H/420; + AC	8 PK 1035 TM
				FAN	MOD: FL12/420/FL12H/420; C-DIM: 767 [mm]; Ø-P: 168;3; + STD-COOL	8 PK 1005 TM
				FAN	MOD: FL12/420/FL12H/420; C-DIM: 767 [mm]; Ø-P: 192;3; + STD-COOL	8 PK 1035 TM
				FAN	MOD: FL12/420/FL12H/420; C-DIM: 767 [mm]; Ø-P: 219;3; + STD-COOL	8 PK 1075 TM
				FAN	MOD: FL12/420/FL12H/420; C-DIM: 926 [mm]; Ø-P: 168;3; + EXT-COOL	8 PK 1020 TM
				FAN	MOD: FL12/420/FL12H/420; C-DIM: 926 [mm]; Ø-P: 192;3; + EXT-COOL	8 PK 1055 TM
				FAN	MOD: FL12/420/FL12H/420; C-DIM: 926 [mm]; Ø-P: 219;3; + EXT-COOL	8 PK 1095 TM

### FM 7

#### 7/250

7300 ccm	184 kW	D7C250	08.98 - 12.01	ALT	MOD: FM 7;FM 7/250; - AC; MTR-CODE: D7C250	10 PK 1580 TM
				ALT	MOD: FM7/250; CRG	10 PK 1950 TM
				ALT	MOD: FM7/250; CRG; + AC	10 PK 2063 TM
				ALT	MOD: FM7/250; NAT-ASP; + AC	10 PK 1690 TM
				ALT	MTR-CODE: D7C250; MOD: FM 7;FM 7/250; - AC	10 PK 1580 TM
				ALT	MTR-CODE: D7C250; MOD: FM 7;FM 7/250; - AC	10 PK 1580 TM
				FAN	MOD: FM7/250	8 PK 1035 TM



## VOLVO

### FM 7

#### 7/290

7300 ccm	213 kW	D7C290	08.98 - 12.01	ALT	MOD: FM7/290; CRG; - AC	10 PK 1950 TM
				ALT	MOD: FM7/290; CRG; + AC	10 PK 2063 TM
				ALT	MOD: FM7/290; NAT-ASP; + AC	10 PK 1690 TM
				ALT	MTR-CODE: D7C290; MOD: FM 7; FM 7/290; - AC	10 PK 1580 TM
				FAN	MOD: FM7/290; + EXT-COOL	8 PK 1005 TM
				FAN	MOD: FM7/290; + STD-COOL	8 PK 1035 TM

### FM 9

#### 9/340

9364 ccm	250 kW	D9A340	12.01 - 09.05	ALT	MOD: FM9/340; - AC	8 PK 1275 TM
				ALT	MOD: FM9/340; + AC	8 PK 1365 TM
				FAN	MOD: FM9/340	10 PK 1350 TM

#### 9/380

9364 ccm	279 kW	D9A380	12.01 - 09.05	ALT	MOD: FM9/380; - AC	8 PK 1275 TM
				ALT	MOD: FM9/380; + AC	8 PK 1365 TM
				FAN	MOD: FM9/380	10 PK 1350 TM

### FM 10

#### 10/320

9600 ccm	235 kW	D10B320	04.99 - 12.01	ALT	MOD: FM10/320; - AC	8 PK 1435 TM
				ALT	MOD: FM10/320; + AC	8 PK 1715 TM
				FAN	OE-NO.: 981331; MOD: FM10/320	10 PK 1070 TM

#### 10/360

9600 ccm	265 kW	D10B360	04.99 - 12.01	ALT	MOD: FM10/360; - AC	8 PK 1435 TM
				ALT	MOD: FM10/360; + AC	8 PK 1715 TM
				FAN	OE-NO.: 981331; MOD: FM10/360	10 PK 1070 TM

### FM 12

#### 12/340

12100 ccm	250 kW	D12C340;D12D340	08.98 - 09.05	ALT	MOD: FM12/340/FM12H/340; - AC	8 PK 800 TM
				ALT	MOD: FM12/340/FM12H/340; + AC	8 PK 955 TM
				FAN	MOD: FM12/340/FM12H/340; + EXT-COOL	10 PK 1108 TM
				FAN	MOD: FM12/340/FM12H/340; + STD-COOL	10 PK 1136 TM

#### 12/380

12100 ccm	279 kW	D12C380;D12D380	08.98 - 09.05	ALT	MOD: FM12/380/FM12H/380; - AC	8 PK 800 TM
				ALT	MOD: FM12/380/FM12H/380; + AC	8 PK 955 TM
				FAN	MOD: FM12/380/FM12H/380; + EXT-COOL	10 PK 1136 TM
				FAN	MOD: FM12/380/FM12H/380; + STD-COOL	10 PK 1108 TM

#### 12/420

12100 ccm	309 kW	D12C420;D12D420	08.98 - 09.05	ALT	MOD: FM12/420/FM12H/420; - AC	8 PK 800 TM
				ALT	MOD: FM12/420/FM12H/420; + AC	8 PK 955 TM
				FAN	MOD: FM12/420/FM12H/420; + EXT-COOL	10 PK 1070 TM
				FAN	MOD: FM12/420/FM12H/420; + STD-COOL	10 PK 1108 TM

#### 12H/340

12100 ccm	250 kW	D12C340;D12D340	08.98 - 09.05	ALT	MOD: FM12/340/FM12H/340; - AC	8 PK 800 TM
				ALT	MOD: FM12/340/FM12H/340; + AC	8 PK 955 TM
				FAN	MOD: FM12/340/FM12H/340; + EXT-COOL	10 PK 1108 TM
				FAN	MOD: FM12/340/FM12H/340; + STD-COOL	10 PK 1136 TM

#### 12H/380

12100 ccm	279 kW	D12C380;D12D380	08.98 - 09.05	ALT	MOD: FM12/380/FM12H/380; - AC	8 PK 800 TM
				ALT	MOD: FM12/380/FM12H/380; + AC	8 PK 955 TM
				FAN	MOD: FM12/380/FM12H/380; + EXT-COOL	10 PK 1136 TM
				FAN	MOD: FM12/380/FM12H/380; + STD-COOL	10 PK 1108 TM

#### 12H/420

12100 ccm	309 kW	D12C420;D12D420	08.98 - 09.05	ALT	MOD: FM12/420/FM12H/420; - AC	8 PK 800 TM
				ALT	MOD: FM12/420/FM12H/420; + AC	8 PK 955 TM
				FAN	MOD: FM12/420/FM12H/420; + EXT-COOL	10 PK 1070 TM
				FAN	MOD: FM12/420/FM12H/420; + STD-COOL	10 PK 1108 TM

### NH 12

#### 12/380

12100 ccm	279 kW	D12C380	05.99 -	AIR-C	MOD: NH 12;380	AVX 13 x 950 TM
				ALT	MOD: NH12/380; - AC	8 PK 800 TM
				ALT	MOD: NH12/380; + AC	8 PK 955 TM
				FAN	MOD: NH12/380	10 PK 1108 TM

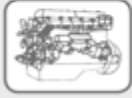

## VOLVO

### NH 12

<b>12/420</b>						
12100 ccm	309 kW	D12C420	05.99 -	AIR-C	MOD: NH 12;420	<b>AVX 13 x 950 TM</b>
				ALT	MOD: NH12/420; - AC	<b>8 PK 800 TM</b>
				ALT	MOD: NH12/420; + AC	<b>8 PK 955 TM</b>
				FAN	OE-NO.: 981335; MOD: NH12/420	<b>10 PK 1108 TM</b>
				FAN	OE-NO.: 981338; MOD: NH12/420	<b>10 PK 1145 TM</b>

**HERSTELLER-TEILENUMMERN**  
**OE PART NUMBERS**  
**RÉFÉRENCES**  
**REFERENCIA ORIGINAL**

**passend für to fit**

Teilenummer Part number	Abmessung Dimension
----------------------------	------------------------

Teilenummer Part number	Abmessung Dimension
----------------------------	------------------------

Teilenummer Part number	Abmessung Dimension
----------------------------	------------------------

**ACURA**

56992PV0003 4 PK 735

**AGCO**

X69661240000	AVX 10 x 1340
X69661260000	AVX 10 x 1310
X69661260200	AVX 10 x 1310
X69661310100	AVX 10 x 825
X69661380100	AVX 10 x 900
X69661390100	AVX 10 x 1215
X69661460100	AVX 10 x 1050
X69661500200	AVX 10 x 1175
X69661520000	AVX 10 x 1200
X69661530100	AVX 10 x 1350
X69661530100	AVX 10 x 1350 TM
X69661540100	AVX 10 x 1225
X69661560100	AVX 10 x 1275
X69661570400	AVX 10 x 1425
X69661610200	AVX 10 x 685
X69661620100	AVX 10 x 1325
X69661630000	AVX 10 x 750
X69661680000	AVX 10 x 1375
X69661780000	AVX 10 x 950
X69661790000	AVX 10 x 1250
X69661920000	AVX 13 x 1100 TM
X69662280000	AVX 13 x 725
X69662290000	AVX 13 x 775
X69662300000	AVX 13 x 865
X69662320000	AVX 13 x 900
X69662320000	AVX 13 x 900 TM
X69662330000	AVX 13 x 918
X69662340000	AVX 13 x 975
X69662340000	AVX 13 x 975 TM
X69662360000	AVX 13 x 1050
X69662360000	AVX 13 x 1050 TM
X69662370000	AVX 13 x 1125
X69662370000	AVX 13 x 1125 TM
X69662380000	AVX 13 x 1150
X69662380000	AVX 13 x 1150 TM
X69662390000	AVX 13 x 1175
X69662390000	AVX 13 x 1175 TM
X69662420000	AVX 13 x 1200
X69662420000	AVX 13 x 1200 TM
X69662440000	AVX 13 x 1225
X69662440000	AVX 13 x 1225 TM
X69662450000	AVX 13 x 1260
X69664200000	AVX 13 x 1400 TM

**ALFA ROMEO**

000111000	ZRK 1212
0060513478	5 PK 1104
0060542280	7 PK 1110
101947	AVX 10 x 888
1019471B	AVX 10 x 888
102500	ZRK 1271
102501	ZRK 1271
110259	AVX 10 x 850
113150210300	AVX 10 x 850
115881010302	5 PK 940
116100210300	AVX 10 x 813
116680210300	AVX 10 x 850
116760210300	AVX 10 x 1100
117010210300	AVX 10 x 825
117020210300	AVX 10 x 1100
117020210301	AVX 10 x 1100
117022383400	AVX 10 x 650

**ALFA ROMEO**

117131010300	AVX 13 x 850
11718AA020	AVX 13 x 975
119001020700	AVX 10 x 875
119130310500	ZRK 1083
119130310501	ZRK 1083
131931	ZRK 1268
162060710300	AVX 10 x 1100
188017	AVX 10 x 875
195172383400	AVX 13 x 1125
195172383406	AVX 13 x 1100
195322710300	AVX 13 x 1050
195510510304	5 PK 820
195510510305	5 PK 985
195510710300	5 PK 1104
46426983	ZRK 1113
464269830	ZRK 1113
46439000	6 PK 1105
46444537	6 PK 1740
46474061	6 PK 1045
46474062	6 PK 1840
46479557	6 PK 1760
46527337	6 PK 1775
46540546	6 PK 1038
46555974	6 PK 1795
46749665	6 PK 1840
46759720	6 PK 1840
46769821	6 PK 1751
46787906	6 PK 1740
46787907	6 PK 1760
46791189	ZRK 1451
51768740	6 PK 2145
51780011	6 PK 2145
55183528	ZRK 1466
55185077	6 PK 1185
55186364	6 PK 1735
55188139	5 PK 1070
55189684	6 PK 1740
55189687	6 PK 1760
55192075	6 PK 1038
55192323	371ST
55193360	6 PK 1580
55193795	5 PK 1145
55201362	6 PK 1735
55201363	6 PK 1725
55202621	6 PK 1318
55210626	ZRK 1306
55210627	ZRK 1700
55210628	ZRK 1249
55212159	371ST
55221254	ZRK 1420
55225504	ZRK 1700
55350421	5 PK 1545
55556430	5 PK 1590
60503002	ZRK 1271
60503994	AVX 10 x 864
60504224	374ST
60504225	375ST
60504835	AVX 10 x 850
60513237	AVX 13 x 1050
60513448	5 PK 820
60513449	5 PK 985
60513478	5 PK 1104
60513614	AVX 10 x 625
60513650	AVX 10 x 825
60513663	AVX 13 x 1015

**ALFA ROMEO**

60515034	ZRK 1268
60517424	AVX 10 x 875
60534452	AVX 13 x 1100
60543218	4 PK 884
60547821	AVX 10 x 825
60548814	AVX 13 x 950
60551888	4 PK 962
60554148	5 PK 940
60556211	ZRK 1132
60560616	5 PK 1015
60561247	7 PK 1970
60562106	ZRK 1083
60566089	5 PK 805
60567578	5 PK 1280
60568842	7 PK 1240
60571125	6 PK 962
60573075	7 PK 1175
60575209	4 PK 763
60585396	5 PK 1015
60590385	7 PK 2050
60595446	7 PK 1715
60596949	5 PK 1005
60597250	5 PK 880
60597794	7 PK 1715
60604835	7 PK 1715
60606518	5 PK 860
60606519	5 PK 860
60607387	7 PK 1080
60607950	7 PK 1950
60617858	7 PK 1080
60617859	7 PK 1950
60617860	6 PK 1045
60617861	6 PK 1045
60617862	6 PK 1840
60617863	6 PK 1840
60618584	7 PK 1970
60620887	ZRK 1420
60621380	228ST
60625128	ZRK 1700
60625129	ZRK 1306
60625590	6 PK 975
60626658	6 PK 1990
60630741	6 PK 1975
60652129	378UT
60652358	7 PK 1970
60652477	228ST
60653027	6 PK 1025
60653028	6 PK 1840
60653029	6 PK 1060
60653030	6 PK 1965
60656340	ZRK 1700
60656341	ZRK 1306
60656342	ZRK 1249
60662969	6 PK 1078
60663242	6 PK 1990
60664403	378UT
60666949	6 PK 1045
60666950	6 PK 1840
60670506	ZRK 1249
60671573	378UT
60672888	ZRK 1700
60676136	6 PK 1060
60676137	6 PK 1025
60704054	AVX 13 x 800
60800148	377UT





Teilenummer Part number	Abmessung Dimension	Teilenummer Part number	Abmessung Dimension	Teilenummer Part number	Abmessung Dimension
<b>ALFA ROMEO</b>		<b>ALFA ROMEO</b>		<b>AUDI</b>	
60800149	ZRK 1309	71739905	5 PK 940	028109119J	ZRK 1290
60805193	4 PK 1100	71739914	7 PK 1950	028109119K	ZRK 1290
60805833	351ST	71739915	6 PK 1840	028109119M	ZRK 1290
60807260	ZRK 1286	71749423	4 PK 962	028109119N	ZRK 1339
60807261	5 PK 1040	71749431	5 PK 920	028109119P	ZRK 1290
60807358	5 PK 1055	71749454	7 PK 2050	028109119S	ZRK 1304
60808219	4 PK 763	71753670	6 PK 1840	028109243	129ST
60808385	7 PK 1240	71753673	6 PK 1975	028109243E	128ST
60808683	ZRK 1253	71753674	6 PK 1990	028109243F	128ST
60808684	5 PK 905	71753677	6 PK 1045	028109243H	238ST
60808685	AVX 10 x 725	71753874	6 PK 1840	028109243J	238ST
60808692	373UT	7614999	ZRK 1286	028109243K	238ST
60808793	5 PK 970	7629031	5 PK 905	028145271F	AVX 11,9 x 903
60809019	4 PK 763	7629229	5 PK 920	028145278A	114SR
60811136	ZRK 1249	76515588	5 PK 970	028145278E	114SR
60811487	373UT	7659062	ZRK 1252	028145278J	143UR
60811488	363UT	7695546	ZRK 1247	028198119	KT 1004
60812344	ZRK 1249	7701471773	KT 1217	028198119A	KT 1021
60812382	ZRK 1420	7702169	5 PK 1055	028198119B	KT 1014
60812429	5 PK 920	7702740	5 PK 1040	028198119C	KT 1358
60812430	5 PK 985	7706132	5 PK 970	028198119D	KT 1308
60812494	6 PK 1045	7749145	5 PK 940	028198119E	KT 1087
60812624	378UT	7766684	6 PK 1038	028198119G	KT 1326
60812714	7 PK 1950	9400831279	KT 1040	028260849A	6 PK 1185
60813206	6 PK 1990	VM46510552A	7 PK 1110	028260849F	6 PK 1185
60813415	378UT	VM46510586F	7 PK 1715	028260849H	6 PK 1175
60813505	6 PK 1105	VM46510591F	7 PK 2050	028903137AJ	5 PK 1590
60813506	6 PK 1038	VM46510600F	7 PK 1715	028903137AK	6 PK 894
60813592	371ST	<b>ALPINE</b>		028903137AR	5 PK 1590
60813720	6 PK 1740	11281437929	6 PK 1555	028903137K	6 PK 894
60813757	6 PK 1840	11287539831	6 PK 1550	034109119	ZRK 1055
60814032	6 PK 1840	6001023554	5 PK 1720	034109119A	ZRK 1231
60814319	ZRK 1249	7700267464	5 PK 1330	034260849	AVX 13 x 915
60814462	228ST	7700268230	AVX 10 x 1250	034260849C	AVX 13 x 1050
60814616	6 PK 1760	<b>AUDI</b>		034903137	AVX 10 x 825
60814847	6 PK 1038	0125130707	6 PK 2500	034903137A	AVX 11,2 x 820
60815189	6 PK 1840	022145933AG	6 PK 1610	034903137B	4 PK 890
60815621	6 PK 1840	022145933N	6 PK 1240	035109119	ZRK 1049
60815666	6 PK 1775	022145933T	6 PK 1625	035145271C	AVX 13 x 1025
60815805	6 PK 1795	026109119B	ZRK 1237	035145271E	AVX 13 x 1025
60815887	6 PK 1840	026109119C	ZRK 1237	035145271F	AVX 13 x 1000
60815889	6 PK 1045	026109243	100UT	035145271G	AVX 10 x 975
60816054	6 PK 1840	026109243A	100UT	035145271J	AVX 10 x 960
60816055	6 PK 1795	026109243C	100UT	035145271J	AVX 10 x 965
60816661	6 PK 1760	026109243E	100UT	035145271P	AVX 13 x 1000
71712677	7 PK 2050	026109243F	100UT	035260849A	AVX 13 x 900
71719007	5 PK 985	026109243G	100UT	035260849C	AVX 13 x 992
71719394	6 PK 1840	026109243J	115UT	035260849G	AVX 13 x 925
71719395	6 PK 1795	026109243L	100UT	035903137A	AVX 10 x 800
71719407	5 PK 970	026145271	AVX 10 x 730	035903137B	AVX 10 x 800
71719648	ZRK 1249	026145271B	AVX 10 x 763	035903137C	AVX 10 x 785
71719649	ZRK 1700	026198119	KT 1135	036109181A	147ST
71719738	4 PK 665	026260849A	AVX 13 x 800	036109243AB	146ST
71731639	ZRK 1113	026903137C	AVX 10 x 950	036109243AC	148ST
71732372	6 PK 1965	027109119A	ZRK 1232	036109243AD	146ST
71732386	6 PK 1060	027109119B	ZRK 1232	036109243AE	148ST
71734715	6 PK 1760	027109243	102ST	036109243AG	148ST
71734716	6 PK 1740	027903137A	AVX 10 x 864	036109243E	146ST
71736710	7 PK 2050	028109119AA	ZRK 1304	036109243K	148ST
71736726	KT 1404	028109119AC	ZRK 1339	036109243L	146ST
71736727	KT 1079	028109119D	ZRK 1290	036109243R	146ST
71739622	5 PK 1104	028109119E	ZRK 1290	036109243S	148ST
71739623	4 PK 962	028109119G	ZRK 1290	036109244C	145UT
71739628	ZRK 1306	028109119H	ZRK 1290	036109244D	145UT
71739873	ZRK 1455			036109244J	145UT



Teilenummer Part number	Abmessung Dimension
----------------------------	------------------------

Teilenummer Part number	Abmessung Dimension
----------------------------	------------------------

Teilenummer Part number	Abmessung Dimension
----------------------------	------------------------

AUDI	
------	--

036145933AG	6 PK 737
036145933AJ	6 PK 1078
036145933F	6 PK 1090
036145933M	6 PK 745
036198119	KT 1374
036198119B	KT 1374
036198119C	KT 1445
036198119E	KT 1209
036198119F	KT 1374
038109119B	ZRK 1305
038109119N	ZRK 1338
038109119P	ZRK 1338
038109119S	ZRK 1338
038109243	155ST
038109243D	155ST
038109243F	155ST
038109243G	155ST
038109243H	155ST
038109243M	162ST
038109243N	155ST
038109244B	132UT
038109244C	132UT
038109244E	150UT
038109244H	132UT
038109244M	132UT
038109244Q	150UT
038145276	140UR
038198119	KT 1238
038198119A	KT 1237
038198119B	KT 1248
038198119C	KT 1237
038198119F	KT 1226
038260849	4 PK 841
038260849A	4 PK 841
038903137	6 PK 906
038903137E	6 PK 1660
038903137G	6 PK 906
038903137H	5 PK 1435
038903137J	6 PK 1660
03F260849A	6 PK 1690
03F903137A	6 PK 1432
03G109119	ZRK 1468
03G109119B	ZRK 1468
03G109243	423ST
03G109244	424UT
03G903137A	6 PK 950
03G903137B	6 PK 1055
03G903137E	6 PK 1610
03L109119	ZRK 1544
03L109119A	ZRK 1544
03L109119B	ZRK 1572
03L109119C	ZRK 1572
03L109119D	ZRK 1544
03L109119E	ZRK 1572
03L109119F	ZRK 1544
03L109119G	ZRK 1572
03L109119J	ZRK 1572
03L109243A	466ST
03L109243E	466ST
03L109244C	160UT
03L109244D	119UT
03L198119	KT 1420
03L903137	6 PK 1070
03L903137A	6 PK 1580
03L998037	6 EPK 842

AUDI	
------	--

040903137A	AVX 10 x 950
045109119D	ZRK 1439
045109119E	ZRK 1439
045109119L	ZRK 1439
045109243A	152ST
045109243B	159ST
045109243C	152ST
045109243D	159ST
045109243F	162ST
045109244A	160UT
045109479B	161ST
045109479C	151ST
045109479D	344ST
045903137D	6 PK 995
045903137E	6 PK 858
046109119	ZRK 1301
046109119E	ZRK 1301
046130113	ZRK 1257
046130113C	ZRK 1257
046130195B	117UT
046130195D	118UT
046145271	AVX 10 x 800
046145271A	AVX 10 x 900
046260849B	AVX 13 x 950
046903137A	6 PK 1330
046903137B	6 PK 1710
046903137M	6 PK 1725
046903137N	6 PK 1345
048109119B	ZRK 1315
048109119G	ZRK 1222
048109243A	123ST
048903137	AVX 10 x 900
049145271A	AVX 10 x 725
049260849A	AVX 13 x 825
049903137A	AVX 10 x 940
049903137A	AVX 10 x 950
049903137B	AVX 10 x 940
049903137B	AVX 10 x 950
049903137D	AVX 10 x 938
049903137D	AVX 10 x 940
050121039A	AVX 10 x 913
050260849	AVX 13 x 800
050903137	AVX 10 x 950
050903137B	4 PK 855
050903137C	4 PK 855
051109243	102ST
051109243A	393ST
052109119	ZRK 1043
052109119A	ZRK 1043
052903137A	AVX 10 x 695
052903137B	AVX 10 x 685
053121039	AVX 10 x 888
053903137	AVX 10 x 900
053903137A	4 PK 890
054109119A	ZRK 1231
054109119E	ZRK 1221
054109119G	ZRK 1231
054109119H	ZRK 1221
054109479	394ST
054109479A	113UT
054903137	AVX 11,2 x 866
054903137A	6 PK 1290
054903137B	6 PK 1695
054903137E	6 PK 1290
054903137F	6 PK 1695

AUDI	
------	--

055260849E	AVX 13 x 1025
055903127G	AVX 10 x 850
055903137G	AVX 10 x 850
056109119A	ZRK 1056
056903137	AVX 10 x 950
058109119A	ZRK 1223
058109119D	ZRK 1223
058109243C	142ST
058109243D	154UT
058109243E	142ST
058109244	119UT
058109479B	141ST
058145271	AVX 11 x 528
058198119	KT 1206
058198119A	KT 1356
058198479	KT 1205
058260511	133SR
058260849	4 PK 855
058260849A	4 PK 855
058903133	134SR
058903133B	134SR
058903133C	134SR
058903133D	134SR
058903137B	5 PK 1300
058903137C	5 PK 1300
058903137E	5 PK 1300
059109119A	ZRK 1464
059109119B	ZRK 1464
059109119D	ZRK 1581
059109243D	244UT
059109243F	297ST
059109243G	297ST
059109243J	244UT
059109243L	297ST
059109244	415UT
059109244A	415UT
059109244B	415UT
059109479B	247ST
059109487A	248ST
059109487B	248ST
059109487C	248ST
059119137	AVX 10 x 1025
059119137A	AVX 10 x 1025
059130113	ZRK 1331
059130113A	ZRK 1331
059130113B	ZRK 1331
059198119A	KT 1246
059198119A	KT 1441
059198119A	KT 1444
059198119B	KT 1246
059198119B	KT 1441
059198119B	KT 1444
059260849B	4 PK 1237
059260849D	4 PK 1218
059903137	AVX 10 x 875
059903137AB	6 PK 2460
059903137AC	6 PK 2475
059903137AE	6 PK 2500
059903137H	6 PK 2404
059903137P	6 PK 2460
059903137T	6 PK 2490
068109119	ZRK 1242
068109119F	ZRK 1242
068109243	101ST
068109243C	101ST

Teilenummer Part number	Abmessung Dimension	Teilenummer Part number	Abmessung Dimension	Teilenummer Part number	Abmessung Dimension
<b>AUDI</b>		<b>AUDI</b>		<b>AUDI</b>	
068109243F	101ST	06D903137C	6 PK 1570	078109243R	137UT
068121039C	AVX 10 x 617	06D903137E	6 PK 1570	078109243S	137UT
068121039F	AVX 10 x 913	06E903137A	6 PK 2415	078109244	113UT
068121039G	AVX 10 x 617	06E903137C	6 PK 2465	078109244C	113UT
068260849H	AVX 13 x 950	06E903137J	6 PK 2415	078109244F	113UT
068903137AE	AVX 13 x 1225	06E903137K	6 PK 2404	078109244G	144UT
068903137AF	AVX 10 x 600	06E903137N	6 PK 2460	078109244H	138UT
068903137AM	AVX 10 x 710	06F198119	KT 1375	078109244J	138UT
068903137AP	AVX 10 x 710	06F198119A	KT 1432	078109479E	139ST
068903137B	AVX 10 x 875	06F260849E	6 PK 1045	078109487A	235UT
068903137F	AVX 10 x 735	06F260849L	6 PK 1055	078198119	KT 1303
068903137S	AVX 10 x 775	06F903137E	6 PK 900	078198119A	KT 1261
069109119A	ZRK 1376	06F903137L	6 PK 955	078198479	KT 1304
069109243B	103UT	06H121605E	ZRK 1585	078903137	6 PK 1675
069130113A	ZRK 1090	06H903137C	6 PK 1590	078903137AJ	6 PK 1900
069145107	AVX 10 x 600	06J260849D	6 PK 1115	078903137AN	6 PK 1635
069145271	AVX 13 x 1050	071145933P	6 DPK 1352	078903137AP	6 PK 1760
06A109119A	KT 1301	074109119	ZRK 1217	078903137AQ	6 PK 1863
06A109119B	ZRK 1216	074109119A	ZRK 1301	078903137AR	6 PK 1870
06A109119C	ZRK 1216	074109119B	ZRK 1301	078903137BC	6 PK 1880
06A109479	120ST	074109119E	ZRK 1301	078903137BD	6 PK 1870
06A109479A	120ST	074109119F	ZRK 1241	078903137BH	6 PK 1740
06A109479B	120ST	074109119H	ZRK 1241	078903137BJ	6 PK 1880
06A109479C	120ST	074109119J	ZRK 1301	078903137BM	6 PK 1740
06A145933D	6 PK 1125	074109119L	ZRK 1301	078903137C	6 PK 2285
06A198119A	KT 1301	074109119P	ZRK 1301	078903137F	6 PK 1685
06A198119B	KT 1230	074109119R	ZRK 1301	078903137K	6 PK 2260
06A260849	6 DPK 1195	074109243	104UT	078903137P	6 PK 2260
06A260849C	6 DPK 1195	074109243A	105ST	078903341J	107UR
06A903315D	135SR	074109243B	112ST	079903137A	5 PK 1110
06A903315E	135SR	074109243F	149ST	079903137AA	5 PK 1110
06B109119A	ZRK 1220	074109243G	149ST	079903137AB	5 PK 1125
06B109119B	ZRK 1220	074109243J	149ST	079903137S	5 PK 1165
06B109119F	ZRK 1220	074109243K	104UT	079903137T	5 PK 1130
06B109119L	ZRK 1220	074109243R	149ST	07K145933E	5 PK 1060
06B109243	230ST	074130113C	ZRK 1270	07K145933R	5 PK 935
06B109243A	127ST	074903137	AVX 10 x 838	07L903137C	5 PK 950
06B109243B	157ST	075145271	AVX 13 x 800	07L903137E	5 PK 1130
06B109243D	127ST	076903137	AVX 10 x 813	07L903137M	5 PK 950
06B109244	156UT	077109119B	ZRK 1236	07L903137T	5 PK 970
06B109477	136ST	077109119D	ZRK 1236	111903137C	AVX 10 x 900
06B109477A	158ST	077109119E	ZRK 1236	1L0198002	KT 1014
06B109479	136ST	077109243A	108ST	6120303301	AVX 10 x 850
06B145933	6 PK 1078	077109244A	140UT	6121708601	AVX 10 x 875
06B198119	KT 1230	077109244C	349UT	6121708701	AVX 10 x 1075
06B260849A	4 PK 855	077109244E	383UT	6121708701	AVX 10 x 1075 TM
06B903137	5 PK 1300	077109479D	348ST	6121780001	AVX 10 x 1100
06B903137C	6 PK 1590	077109485C	347ST	6121780002	AVX 10 x 1075
06B903137D	6 PK 1590	077109485E	347ST	6121780002	AVX 10 x 1075 TM
06B903137E	5 PK 1300	077109485F	347ST	6Q0260849C	6 PK 1735
06B903137J	6 PK 1570	077903137D	6 PK 2460	6Q0903137A	6 PK 1090
06C109119C	ZRK 1433	077903137H	6 PK 2475	89202057101	AVX 10 x 1125
06C109244C	429UT	077903137K	6 PK 2680	89203057100	AVX 10 x 735
06C109479A	430ST	077903137Q	6 PK 2680		
06C109485A	427ST	077903341	110UR	<b>AUSTIN</b>	
06C198119	KT 1429	078109119A	ZRK 1279	13H924	AVX 10 x 938
06C198119	KT 1439	078109119C	ZRK 1229	2A414	AVX 10 x 813
06C903137C	6 PK 1930	078109119D	ZRK 1279	2A801	AVX 10 x 813
06C903137D	6 PK 1920	078109119G	ZRK 1229	AAU3577	AVX 10 x 825
06C903137E	6 PK 1885	078109119H	ZRK 1229	AAU8072	AVX 10 x 875
06D109119B	ZRK 1443	078109119J	ZRK 1229	ADU4236	AVX 10 x 825
06D109119D	ZRK 1443	078109243A	106ST	ADU6528	AVX 10 x 938
06D109243	387ST	078109243C	106ST	ADU7785	4 PK 825
06D109244A	386UT	078109243K	130UT	ADU7786	4 PK 962
06D109244B	386UT	078109243Q	137UT	AEC289	AVX 10 x 1150



Teilenummer Part number	Abmessung Dimension
----------------------------	------------------------

Teilenummer Part number	Abmessung Dimension
----------------------------	------------------------

Teilenummer Part number	Abmessung Dimension
----------------------------	------------------------

**AUSTIN**

AEC619	AVX 10 x 1175
AEJ101	AVX 10 x 838
AEJ63	AVX 10 x 850
AHU2174	4 PK 890
CDU2749	ZRK 1151
FDU1466	ZRK 1166
GCB10700	AVX 10 x 700
GCB10825	AVX 10 x 825
GCB10838	AVX 10 x 838
GCB10876	AVX 10 x 925
GCB10937	AVX 10 x 938
GCB10950	AVX 10 x 950
GCB50765	AVX 10 x 750
GFB10725	AVX 10 x 710
GFB10775	AVX 10 x 775
GFB10813	AVX 10 x 800
GFB10825	AVX 10 x 825
GFB10838	AVX 10 x 838
GFB10900	AVX 10 x 900
GFB10950	AVX 10 x 950
GFB10975	AVX 10 x 975
GFB11044	AVX 10 x 1050
GFB189	AVX 13 x 1075
GFB272	AVX 10 x 938
GFB60937	AVX 10 x 938
GFB701	AVX 10 x 938
GFB80760	4 PK 763
GFB80823	4 PK 825
GFB80890	4 PK 890
GFB90790	5 PK 790
GFB90890	5 PK 890
GMB40890	4 PK 890
GTB1207	ZRK 1142
GTB1238	ZRK 1151
GTB1253	ZRK 1150
GTB1291	ZRK 1171
GTB2003	ZRK 1077
GTB2004	ZRK 1076
GTB2006	ZRK 1262
GTB2016XS	ZRK 1166
TKC2802	AVX 10 x 938
WAM2804	ZRK 1150

**AUSTIN-WESTERN**

AEC932	AVX 10 x 1110
--------	---------------

**AUTOBIANCHI**

46426983	ZRK 1113
464269830	ZRK 1113
60814603	ZRK 1113
7554701	ZRK 1111
7636448	3 PK 675
7704978	4 PK 675
7750728	3 PK 685
98415921	ZRK 1316
98419390	ZRK 1312

**BEDFORD**

2696273	AVX 10 x 1110
2696274	AVX 10 x 1225
2696275	AVX 10 x 1225
2696277	AVX 10 x 1275
2696493	AVX 10 x 1350
2696493	AVX 10 x 1350 TM
5134215	AVX 13 x 1150

**BEDFORD**

5134215	AVX 13 x 1150 TM
6322716	AVX 10 x 925
6326788	AVX 13 x 1225
6326788	AVX 13 x 1225 TM
6326789	AVX 13 x 1050
6326789	AVX 13 x 1050 TM
6339100	AVX 13 x 1125
6339100	AVX 13 x 1125 TM
6339364	AVX 13 x 1475
6339364	AVX 13 x 1475 TM
6376165	AVX 10 x 1000
6376167	AVX 10 x 950
6376168	AVX 10 x 975
6376385	AVX 10 x 1000
6376562	AVX 13 x 1050
6376562	AVX 13 x 1050 TM
7173428	AVX 13 x 1050
7173428	AVX 13 x 1050 TM
7180681	AVX 13 x 1475
7180681	AVX 13 x 1475 TM
7180684	AVX 10 x 1000
7180685	AVX 10 x 950
7180686	AVX 10 x 975
7180689	AVX 10 x 1150
7180691	AVX 10 x 1110
7180693	AVX 10 x 1110
7184116	AVX 10 x 1375
7184180	AVX 10 x 1000
7201034	AVX 10 x 1350
7201034	AVX 10 x 1350 TM
7203068	AVX 10 x 960
8835134	AVX 10 x 1140
8835135	AVX 13 x 1200
8835135	AVX 13 x 1200 TM
8835203	AVX 10 x 950
8835275	AVX 10 x 1225
8835402	AVX 10 x 913
8835487	AVX 10 x 1110
8839164	AVX 10 x 1225
8851716	AVX 10 x 950
8851717	AVX 10 x 913
8854515	AVX 13 x 1200
8854515	AVX 13 x 1200 TM
91112009	ZRK 1034
93891618	AVX 13 x 875
93891618	AVX 13 x 875 TM
93891628	AVX 13 x 1025
93891628	AVX 13 x 1025 TM
94029834	ZRK 1269
94111624	AVX 13 x 1500
94111624	AVX 13 x 1500 TM
94141721	AVX 13 x 1025
94141721	AVX 13 x 1025 TM
94232287	AVX 13 x 875
94232287	AVX 13 x 875 TM
94256977	AVX 10 x 660
94257037	AVX 13 x 1000
94257037	AVX 13 x 1000 TM
9966579	AVX 10 x 1225
9966580	AVX 10 x 1225
9966583	AVX 10 x 1110
9966584	AVX 10 x 1275

**BEIJING BENZ (BBDC)**

SMD336149	ZRK 1176
-----------	----------

**BEIJING BENZ (BBDC)**

SMR994968	ZRK 1176
-----------	----------

**BERLIET**

0000323580	AVX 13 x 1425
0000323580	AVX 13 x 1425 TM
0000323722	AVX 13 x 1225
0000323722	AVX 13 x 1225 TM
0000323948	AVX 13 x 1425
0000323948	AVX 13 x 1425 TM
0023223161	AVX 10 x 935
22233065	AVX 13 x 1475
22233065	AVX 13 x 1475 TM
23222114	AVX 10 x 1050
23223003	AVX 13 x 800
23223003	AVX 13 x 800 TM
23223042	AVX 10 x 1050
23223047	AVX 13 x 1500
23223047	AVX 13 x 1500 TM
23223048	AVX 10 x 710
23223064	AVX 13 x 1450
23223064	AVX 13 x 1450 TM
23223068	AVX 13 x 1500
23223068	AVX 13 x 1500 TM
23223072	AVX 13 x 1250
23223072	AVX 13 x 1250 TM
23223073	AVX 10 x 1525
23223074	AVX 13 x 1625
23223074	AVX 13 x 1625 TM
23223078	AVX 13 x 1100 TM
23223080	AVX 10 x 1200
23223083	AVX 10 x 850
23223086	AVX 10 x 950
23223093	AVX 10 x 1125
23223097	AVX 10 x 1300
23223101	AVX 13 x 1675
23223101	AVX 13 x 1675 TM
23223106	AVX 13 x 950
23223106	AVX 13 x 950 TM
23223107	AVX 13 x 1175
23223107	AVX 13 x 1175 TM
23223111	AVX 10 x 1140
23223117	AVX 13 x 1375
23223117	AVX 13 x 1375 TM
23223118	AVX 10 x 730
23223125	AVX 13 x 1100 TM
23223131	AVX 13 x 1275
23223131	AVX 13 x 1275 TM
23223132	AVX 13 x 1150
23223132	AVX 13 x 1150 TM
23223133	AVX 13 x 1225
23223133	AVX 13 x 1225 TM
23223134	AVX 13 x 1100 TM
23223136	AVX 13 x 1225
23223136	AVX 13 x 1225 TM
23223137	AVX 13 x 1625
23223137	AVX 13 x 1625 TM
23223138	AVX 13 x 1700
23223138	AVX 13 x 1700 TM
23223139	AVX 13 x 925
23223139	AVX 13 x 925 TM
23223140	AVX 13 x 1275
23223140	AVX 13 x 1275 TM
23223141	AVX 13 x 1450
23223141	AVX 13 x 1450 TM
23223142	AVX 13 x 1475



Teilenummer Part number	Abmessung Dimension	Teilenummer Part number	Abmessung Dimension	Teilenummer Part number	Abmessung Dimension
<b>BERLIET</b>		<b>BERLIET</b>		<b>BMW</b>	
23223142	AVX 13 x 1475 TM	323665	AVX 13 x 1325 TM	11231709638	AVX 10 x 864
23223143	AVX 13 x 1100 TM	323667	AVX 13 x 1625	11231716201	AVX 13 x 1050
23223147	AVX 13 x 1625	323667	AVX 13 x 1625 TM	11231717016	AVX 10 x 990
23223147	AVX 13 x 1625 TM	323674	AVX 13 x 1250	11231717952	AVX 10 x 1013
23223148	AVX 13 x 1700	323674	AVX 13 x 1250 TM	11231721408	AVX 10 x 1025
23223148	AVX 13 x 1700 TM	323719	AVX 13 x 950	11281247051	212SR
23223156	AVX 10 x 913	323719	AVX 13 x 950 TM	11281247284	6 PK 1660
23223157	AVX 10 x 975	323720	AVX 13 x 1150	11281247986	6 PK 1660
23223278	AVX 13 x 1375	323720	AVX 13 x 1150 TM	11281401157	6 PK 1515
23223278	AVX 13 x 1375 TM	323721	AVX 10 x 913	11281401159	5 PK 1125
23223279	AVX 13 x 1225	323722	AVX 13 x 1225	11281401162	5 PK 790
23223279	AVX 13 x 1225 TM	323722	AVX 13 x 1225 TM	11281404018	6 PK 1515
23223284	AVX 13 x 1500	323738	AVX 10 x 1250	11281407975	7 PK 1440
23223284	AVX 13 x 1500 TM	323783	AVX 10 x 1175	11281427250	6 PK 1555
23223285	AVX 13 x 1175	323804	AVX 13 x 1500	11281432724	7 PK 1630
23223285	AVX 13 x 1175 TM	323804	AVX 13 x 1500 TM	11281433948	5 PK 950
23223288	AVX 10 x 1140	323822	AVX 13 x 1175	11281435280	5 PK 1005
23223289	AVX 10 x 775	323822	AVX 13 x 1175 TM	11281437368	6 PK 1555
23223296	AVX 13 x 1050	323823	AVX 13 x 1275	11281437369	6 PK 1735
23223296	AVX 13 x 1050 TM	323823	AVX 13 x 1275 TM	11281437449	5 PK 905
23223478	AVX 13 x 1250	323858	AVX 13 x 925	11281437450	5 PK 865
23223478	AVX 13 x 1250 TM	323858	AVX 13 x 925 TM	11281437475	6 PK 1540
23223482	AVX 13 x 1375	323859	AVX 13 x 1275	11281437869	6 PK 1710
23223482	AVX 13 x 1375 TM	323859	AVX 13 x 1275 TM	11281437872	5 PK 865
23223485	AVX 13 x 1075 TM	323876	AVX 13 x 1150	11281437873	5 PK 905
23255705	AVX 13 x 1375	323876	AVX 13 x 1150 TM	11281437874	5 PK 950
23255705	AVX 13 x 1375 TM	323877	AVX 13 x 925	11281437875	4 PK 890
322225	AVX 13 x 1325	323877	AVX 13 x 925 TM	11281437880	6 PK 1735
322225	AVX 13 x 1325 TM	323878	AVX 13 x 1275	11281437929	6 PK 1555
322226	AVX 13 x 1675	323878	AVX 13 x 1275 TM	11281438276	6 PK 1540
322226	AVX 13 x 1675 TM	323879	AVX 13 x 1225	11281703561	6 PK 1555
323060	AVX 13 x 1375	323879	AVX 13 x 1225 TM	11281703943	5 PK 890
323060	AVX 13 x 1375 TM	323889	AVX 13 x 1450	11281703944	5 PK 905
323189	AVX 13 x 1500	323889	AVX 13 x 1450 TM	11281704719	7 PK 1035
323189	AVX 13 x 1500 TM	323890	AVX 13 x 1475	11281706545	6 PK 1540
323225	AVX 13 x 1325	323890	AVX 13 x 1475 TM	11281710958	6 PK 1190
323225	AVX 13 x 1325 TM	323967	AVX 13 x 1175	11281715626	208SR
323226	AVX 13 x 1675	323967	AVX 13 x 1175 TM	11281715630	206SR
323226	AVX 13 x 1675 TM	383575	AVX 13 x 1475	11281715636	5 PK 1165
323276	AVX 13 x 1175	383575	AVX 13 x 1475 TM	11281715770	6 PK 1078
323276	AVX 13 x 1175 TM	5000681020	AVX 13 x 1375	11281717188	209SR
323345	AVX 13 x 1675	5000681020	AVX 13 x 1375 TM	11281717210	211SR
323345	AVX 13 x 1675 TM	5000681405	AVX 13 x 1375	11281720039	206SR
323359	AVX 13 x 1125	5000681405	AVX 13 x 1375 TM	11281725731	6 PK 1078
323359	AVX 13 x 1125 TM	<b>BMW</b>		11281726181	206UR
323453	AVX 13 x 1075 TM	07119990150	AVX 10 x 850	11281726343	205SR
323462	AVX 13 x 1150	07119990151	AVX 10 x 825	11281726689	6 PK 1555
323462	AVX 13 x 1150 TM	07119990161	AVX 10 x 950	11281726690	5 PK 890
323555	AVX 13 x 1175	07119990174	AVX 10 x 1025	11281729211	5 PK 1155
323555	AVX 13 x 1175 TM	07119990174	AVX 13 x 1025	11281730571	206UR
323561	AVX 13 x 1525	07119990175	AVX 13 x 1050	11281731220	215UR
323566	AVX 13 x 1675	07119990178	AVX 10 x 1125	11281731838	216UR
323566	AVX 13 x 1675 TM	07119990181	AVX 10 x 1075	11281735190	6 PK 1560
323568	AVX 13 x 1125	07119990181	AVX 10 x 1075 TM	11281735194	6 PK 1560
323568	AVX 13 x 1125 TM	0711999175	AVX 13 x 1050	11281735195	6 PK 1570
323575	AVX 13 x 1475	11211258120	AVX 10 x 975	11281736717	6 PK 1078
323575	AVX 13 x 1475 TM	11231141172	AVX 10 x 1000	11281736759	5 PK 975
323586	AVX 13 x 1450	11231266125	AVX 10 x 950	11281736986	7 PK 1605
323586	AVX 13 x 1450 TM	11231279479	AVX 10 x 1000	11281736988	5 PK 975
323591	AVX 13 x 1475	11231315137	AVX 13 x 1050	11281738061	206UR
323591	AVX 13 x 1475 TM	11231315137	AVX 13 x 1055	11281738605	206UR
323593	AVX 13 x 1100 TM	11231706668	AVX 13 x 1050	11281738988	5 PK 905
323594	AVX 10 x 1250	11231706788	AVX 13 x 1050	11281739470	4 PK 890
323610	AVX 13 x 1075 TM	11231706788	AVX 13 x 1050	11281739816	6 PK 1735
323665	AVX 13 x 1325	11231709636	AVX 10 x 864	11281741427	6 PK 1195





Teilenummer Part number	Abmessung Dimension	Teilenummer Part number	Abmessung Dimension	Teilenummer Part number	Abmessung Dimension
<b>BMW</b>		<b>BMW</b>		<b>BMW</b>	
11281742012	7 PK 1605	11287790919	3 EPK 885	12311284317	AVX 10 x 950
11281742029	5 PK 1005	11287791786	4 EPK 830	12311284740	AVX 10 x 938
11281742475	7 PK 1630	11287792059	6 PK 2065	12311288475	AVX 10 x 960
11281743193	4 PK 890	11287792851	4 EPK 860	12311288475	AVX 10 x 965
11281744986	5 PK 865	11287794070	4 EPK 811	12318602025	AVX 10 x 875
11281745551	206SR	11287795144	4 EPK 917	12348602026	AVX 10 x 850
11281747922	7 PK 1040	11287795601	6 PK 1685	1247051	212SR
11281748130	206UR	11287800345	6 DPK 1817	1254885	AVX 10 x 965
11281748131	205SR	11287800485	6 PK 1795	12582394	AVX 10 x 825
11282243510	219SR	11287802186	6 PK 1550	1258400	AVX 13 x 1060
11282243732	4 PK 780	11287803476	6 PK 1890	12600134	AVX 13 x 1085
11282244179	5 PK 1815	11287830946	5 PK 830	12600954	AVX 13 x 1085
11282244424	219SR	11287832327	6 PK 1460	12600964	AVX 10 x 685
11282245028	5 PK 1850	11287833264	7 PK 1630	12600974	AVX 10 x 800
11282245087	210SR	11287833265	7 PK 1440	12601094	AVX 10 x 913
11282245848	5 PK 1815	11287833266	5 PK 975	12602564	AVX 10 x 975
11282245948	5 PK 1885	11287835483	6 PK 1090	12602934	AVX 13 x 825
11282246769	219SR	11287837898	6 PK 1460	1263536	AVX 10 x 813
11282247191	5 PK 2030	11287838200	6 PK 1070	12647284	AVX 10 x 775
11282247493	5 PK 2063	11287841228	206UR	12661224	AVX 10 x 950
11282248168	219SR	11287841529	6 PK 1100	12667864	AVX 10 x 900
11282248208	7 PK 1453	11288506994	6 DPK 1817	1268676	AVX 10 x 875
11284496457	5 PK 812	11288512069	6 DPK 1817	12686764	AVX 10 x 875
11286550645	4 EPK 917	11311268697	AVX 10 x 975	12686784	AVX 10 x 875
11287507626	5 PK 1025	11311272384	ZRK 1009	12686794	AVX 10 x 850
11287508239	7 PK 1040	11311272424	200ST	12686814	AVX 10 x 825
11287509520	6 PK 1450	11311279125	ZRK 1263	12686834	AVX 13 x 825
11287511476	6 PK 1870	11311279241	217ST	1268684	AVX 13 x 850
11287512563	4 PK 845	11311286168	ZRK 1009	12686854	AVX 13 x 1055
11287512762	4 PK 860	11311287463	217ST	1268687	AVX 10 x 1075
11287512970	6 PK 1555	11311708806	203UT	1268687	AVX 10 x 1075 TM
11287512971	4 PK 860	11311709646	203UT	1268688	AVX 10 x 1125
11287512972	7 PK 1040	11311711153	200ST	12686954	AVX 13 x 800
11287515316	6 PK 1642	11311713361	ZRK 1010	12686984	AVX 10 x 975
11287516181	6 PK 1555	11311715400	ZRK 1122	12687864	AVX 10 x 900
11287519955	7 PK 1630	11311717215	ZRK 1045	1269517	AVX 13 x 835
11287520072	6 PK 1560	11311721245	204ST	12695174	AVX 13 x 835
11287520177	4 EPK 844	11311721263	204ST	1270454	AVX 10 x 775
11287525418	6 PK 1550	11311721264	202UT	12708704	AVX 10 x 864
11287527564	6 PK 1990	11311721274	ZRK 1122	1272424	200ST
11287529738	6 PK 1555	11311721699	ZRK 1122	1279126	ZRK 1263
11287529741	6 PK 1550	11311721844	213SK	12791262	ZRK 1263
11287532144	6 PK 1830	11311726699	210SR	1279241	217ST
11287532145	6 PK 1870	11311727141	202UT	1279480	AVX 10 x 995
11287532146	6 PK 1642	11311727611	201ST	12794804	AVX 10 x 995
11287539831	6 PK 1550	11311734608	ZRK 1122	1284567	AVX 13 x 1055
11287542864	6 PK 1550	11312241090	217ST	1284740	AVX 10 x 940
11287544786	6 PK 1555	11317805960	331ST	12847404	AVX 10 x 940
11287546164	4 EPK 885	11317805961	332UT	128617	AVX 10 x 1525
11287547965	7 PK 1915	11511706710	AVX 10 x 960	1287463	217ST
11287549150	6 PK 1990	11511706710	AVX 10 x 965	12882914	AVX 10 x 813
11287549643	6 PK 1830	12311254885	AVX 10 x 960	1289614	AVX 13 x 930
11287552233	6 PK 1870	12311254885	AVX 10 x 965	13043924	AVX 13 x 1060
11287552236	6 PK 1642	12311254886	AVX 13 x 1025	13115794	AVX 10 x 813
11287557257	7 PK 1370	12311256920	AVX 13 x 1050	1312097	AVX 10 x 1000
11287560485	7 PK 1105	12311258400	AVX 13 x 1050	1312976	AVX 13 x 765
11287580769	7 PK 1473	12311260531	AVX 13 x 1050	1312977	AVX 13 x 975
11287628650	6 PK 1990	12311260531	AVX 13 x 1060	13129774	AVX 10 x 975
11287785774	5 PK 2063	12311260568	AVX 10 x 975	131350	AVX 13 x 1600
11287786075	6 PK 2080	12311260569	AVX 13 x 1050	1315082	AVX 13 x 800
11287787368	5 PK 2030	12311268675	AVX 10 x 875	1315083	AVX 10 x 888
11287787369	5 PK 2063	12311268678	AVX 10 x 850	1315137	AVX 13 x 1055
11287787516	5 PK 2020	12311268697	AVX 10 x 975	1315233	AVX 13 x 992
11287789985	6 PK 2160	12311278250	AVX 10 x 938	131539401	AVX 13 x 725
11287790450	6 PK 1840	12311278250	AVX 10 x 940	131539404	AVX 13 x 725



Teilenummer Part number	Abmessung Dimension
----------------------------	------------------------

Teilenummer Part number	Abmessung Dimension
----------------------------	------------------------

Teilenummer Part number	Abmessung Dimension
----------------------------	------------------------

**BMW**

1316785	AVX 10 x 813
1326486	AVX 10 x 800
13311260531	AVX 13 x 1060
1333332	AVX 10 x 1275
17065964	AVX 10 x 825
1706668	AVX 13 x 1055
17066684	AVX 13 x 1055
170669	AVX 13 x 1055
1706710	AVX 10 x 965
17067104	AVX 10 x 965
1706711	AVX 10 x 965
17067114	AVX 10 x 965
1706751	AVX 10 x 888
1706825	AVX 10 x 825
17068254	AVX 10 x 825
1706826	AVX 13 x 810
17068264	AVX 13 x 800
170856	AVX 13 x 1250
1708806	203UT
17088794	AVX 13 x 835
1709638	AVX 10 x 864
17096384	AVX 10 x 864
1709646	203UT
17107604	AVX 13 x 810
1711058	AVX 13 x 800
17110584	AVX 13 x 800
1711065	AVX 10 x 900
17110654	AVX 10 x 900
17110664	AVX 10 x 900
1711081	ZRK 1010
1711082	ZRK 1010
17111444	AVX 10 x 913
1711153	200ST
17115514	AVX 13 x 850
1713021	AVX 13 x 850
17130214	AVX 13 x 850
1713361	ZRK 1010
1715626	208SR
1715630	206SR
1716201	AVX 13 x 1060
17169584	AVX 13 x 835
1716960	AVX 13 x 835
17169604	AVX 13 x 835
1717012	AVX 10 x 818
1717016	AVX 10 x 980
17170164	AVX 10 x 980
1717188	209SR
1717210	211SR
1717215	ZRK 1045
1717230	AVX 13 x 825
1717599	AVX 10 x 850
1717952	AVX 10 x 1013
17179524	AVX 10 x 1013
1717953	AVX 10 x 800
17179534	AVX 10 x 800
1717954	AVX 13 x 835
1717954	AVX 13 x 840
17185D	AVX 13 x 825
1718757	AVX 10 x 1025
1718953	AVX 10 x 888
17189584	AVX 10 x 888
1719095	AVX 13 x 1075
1720039	206SR
17206454	AVX 10 x 850
1720826	AVX 13 x 925

**BMW**

1721245	204ST
1721263	204ST
1721264	202UT
1721408	AVX 10 x 1025
17214084	AVX 10 x 1025
1721844	213SK
17223714	AVX 13 x 925
1722991	AVX 13 x 825
1726181	206UR
1726343	205SR
1726699	210SR
1727141	202UT
1727180	AVX 10 x 730
17271804	AVX 10 x 730
1727378	4 PK 855
1727611	201ST
1730571	206UR
1731104	AVX 13 x 1000
1731220	215UR
1731838	216UR
173494	AVX 13 x 1600
1737925	AVX 10 x 1175
1738061	206UR
1738605	206UR
1745551	206SR
1748130	206UR
1748131	205SR
1748321	210SR
1761869	AVX 13 x 1075
2240227	ZRK 1263
22406134	AVX 10 x 1000
2240713	AVX 10 x 995
2241090	217ST
22411724	AVX 10 x 995
2242079	218UK
2243045	AVX 10 x 1005
2243510	219SR
2244172	210SR
2244173	210SR
2244424	219SR
2245087	210SR
2246769	219SR
2248168	219SR
32411258276	AVX 10 x 900
32411266788	AVX 10 x 900
32411268681	AVX 10 x 825
32411270869	AVX 10 x 864
32411274563	AVX 10 x 913
32411276314	AVX 10 x 825
32411288291	AVX 10 x 813
32411711144	AVX 10 x 913
32421311578	AVX 10 x 813
32421316785	AVX 10 x 813
32421706750	AVX 10 x 888
32421706825	AVX 10 x 825
32421711065	AVX 10 x 900
32421717011	AVX 10 x 825
32421717953	AVX 10 x 775
32421727180	AVX 10 x 730
3899744	AVX 10 x 825
42290189	AVX 13 x 910
641717954	AVX 13 x 850
64521258239	AVX 13 x 825
64521263075	AVX 13 x 825
64521268683	AVX 13 x 825

**BMW**

64521268695	AVX 13 x 800
64521276096	AVX 13 x 825
64521289592	AVX 13 x 800
64521354948	AVX 13 x 800
64521706826	AVX 13 x 800
64521711056	AVX 13 x 800
64521722371	AVX 13 x 925
645221354948	AVX 13 x 800
64541256610	AVX 13 x 850
64551716960	AVX 13 x 825
64551721844	213SK
64551722990	AVX 13 x 825
64551726699	210SR
64551727378	4 PK 855
64551739470	4 PK 890
64551748321	210SR
64552242079	218UK
64552242867	218UK
64552243732	4 PK 780
64552244172	210SR
64552244173	210SR
64552245179	4 PK 790
64552245451	4 PK 780
64552245850	4 PK 841
64552246732	4 PK 780
64552247183	5 PK 835
64552247425	5 PK 812
64552248190	5 PK 1125
64557785212	4 PK 970
64557786170	5 PK 812
64557786171	5 PK 835
64557786705	4 PK 884
64557787898	5 PK 920
64557792851	4 EPK 860
64557793608	4 EPK 850
64557795144	4 EPK 917
64557809801	4 EPK 867
6550645	4 EPK 917
7520177	4 EPK 844
7546164	4 EPK 885
7791786	4 EPK 830
7792851	4 EPK 860
7793608	4 EPK 850
7794070	4 EPK 811
7795144	4 EPK 917
7809801	4 EPK 867
7841228	206UR
9990150	AVX 10 x 850
99901529	AVX 10 x 800
9990155	AVX 10 x 875
99901699	AVX 10 x 975
9990174	AVX 13 x 1025
9990175	AVX 13 x 1050
99907749	AVX 13 x 1025
99991519	AVX 10 x 825

**BUESSING**

720500106	AVX 10 x 1150
720500107	AVX 10 x 750
720500108	AVX 10 x 1300
720500110	AVX 10 x 875
720500113	AVX 10 x 600
720500114	AVX 10 x 625
720500117	AVX 10 x 800
720500121	AVX 10 x 850



Teilenummer Part number	Abmessung Dimension
----------------------------	------------------------

Teilenummer Part number	Abmessung Dimension
----------------------------	------------------------

Teilenummer Part number	Abmessung Dimension
----------------------------	------------------------

**BUESSING**

720500125	AVX 10 x 925
720500128	AVX 10 x 850
720500129	AVX 10 x 1050
720500131	AVX 13 x 1100 TM
720500133	AVX 10 x 1250
720500134	AVX 10 x 1200
720500135	AVX 10 x 1375
720500138	AVX 10 x 1425
720500200	AVX 13 x 1125
720500200	AVX 13 x 1125 TM
720500201	AVX 13 x 1225
720500201	AVX 13 x 1225 TM
720500204	AVX 13 x 875
720500204	AVX 13 x 875 TM
720500205	AVX 13 x 975
720500205	AVX 13 x 975 TM
720500206	AVX 13 x 950
720500206	AVX 13 x 950 TM
720500207	AVX 13 x 1050
720500207	AVX 13 x 1050 TM
720500208	AVX 13 x 950
720500208	AVX 13 x 950 TM
720500210	AVX 13 x 1175
720500210	AVX 13 x 1175 TM
720500211	AVX 13 x 1425
720500211	AVX 13 x 1425 TM
720500213	AVX 13 x 1250
720500213	AVX 13 x 1250 TM
720500215	AVX 13 x 1275
720500215	AVX 13 x 1275 TM
720500217	AVX 13 x 1325
720500217	AVX 13 x 1325 TM
720500220	AVX 13 x 1350 TM
720500221	AVX 13 x 1450
720500221	AVX 13 x 1450 TM
720500223	AVX 13 x 1475
720500223	AVX 13 x 1475 TM
720500225	AVX 13 x 1525
720500226	AVX 13 x 1550
720500226	AVX 13 x 1550 TM
720500228	AVX 13 x 1600
720500228	AVX 13 x 1600 TM
720500229	AVX 13 x 1100 TM
720500232	AVX 13 x 1150
720500232	AVX 13 x 1150 TM
720500234	AVX 13 x 1075 TM
720500235	AVX 13 x 1000
720500235	AVX 13 x 1000 TM
720500237	AVX 13 x 1700
720500237	AVX 13 x 1700 TM
720500247	AVX 13 x 750
720500247	AVX 13 x 750 TM
720500248	AVX 13 x 900
720500248	AVX 13 x 900 TM
720500431	AVX 13 x 1125
720500431	AVX 13 x 1125 TM
720500441	AVX 13 x 1125
720500441	AVX 13 x 1125 TM
720500446	AVX 13 x 1300
720500446	AVX 13 x 1300 TM
720500450	AVX 13 x 1325
720500450	AVX 13 x 1325 TM

**CADILLAC**

12576447	4 PK 962
12578001	6 PK 1205
12578002	6 PK 1185
1340527	6 PK 2120
55556404	5 PK 1030
93185756	6 PK 2120
93190810	6 PK 1395

**CASE IH**

J911562	8 PK 1460 TM
---------	--------------

**CHEVROLET**

12576447	4 PK 962
12576451	6 PK 2360
12579229	6 PK 2020
212310410201	5 PK 1885
24466972	5 PK 1030
55186793	6 PK 1413
55350419	5 PK 1450
55563925	6 PK 1555
55565301	6 PK 1450
9128725	ZRK 1023
92063917	ZRK 1291
92066312	ZRK 1291
9433724	AVX 10 x 913
9433734	AVX 10 x 1050
9433746	AVX 10 x 1175
96183108	6 PK 1870
96183110	6 PK 884
96183352	ZRK 1182
96239401	4 PK 913
96239408	4 PK 665
96309968	6 PK 1890
96350327	6 PK 1725
96352517	4 PK 735
96404087	6 PK 1840
96417177	ZRK 1182
96440421	6 PK 2065
96444475	4 PK 790
96476110	5 PK 1570
96568068	3 PK 668
96569402	4 PK 735
96570669	4 PK 715
96570670	4 PK 665
96603461	4 PK 954
96610562	4 PK 950
96610564	4 PK 835
96628779	6 PK 2404
96628792	6 PK 1890
96814098	ZRK 1182
96989017	6 PK 2065
96990678	6 PK 1870

**CHRYSLER**

0149971892	6 PK 1600
04593668AA	6 PK 2373
04593823AA	6 PK 1740
04612716	7 PK 1400
04612716AB	7 PK 1400
04621844	ZRK 1584
04668241	4 PK 850
04668380AA	4 PK 875
04668382AB	4 PK 1415
04668382AC	4 PK 1415
04668444AC	4 PK 1290

**CHRYSLER**

04668452	6 PK 1445
04668454AB	6 PK 894
04792070	6 PK 1570
04792070AB	6 PK 1600
04792409AC	6 PK 1400
04792442	6 PK 1570
04792442AA	6 PK 1570
04792746AD	6 PK 1345
04861733AC	6 PK 1250
04861734AA	6 PK 1420
04861735AA	4 EPK 906
04891505AB	6 PK 1440
04891506AC	6 PK 884
04891587AA	7 PK 2035
04891587AB	7 PK 2035
04891804AA	6 PK 1730
04891935AB	4 PK 920
04892173AA	6 PK 1600
04892711AA	4 PK 985
04892747AA	4 PK 985
04892748AA	6 PK 1400
04892749AB	4 PK 900
05066932AA	4 EPK 906
1340A005	5 PK 940
2129277	AVX 13 x 1100
2806959	AVX 13 x 1625
3937789	AVX 10 x 1175
4027313	AVX 10 x 1175
4027331	AVX 10 x 1075
4027331	AVX 10 x 1075 TM
4060987	6 PK 2510
4298096	4 PK 763
4298115	4 PK 1040
4387549	ZRK 1178
4448639	5 PK 1815
4483174	4 PK 980
4573013	6 PK 1345
4573013AB	6 PK 1345
4573234	6 PK 1700
4573727	6 PK 1432
4573737	4 PK 970
4573974	6 PK 1345
4593668AA	6 PK 2373
4593684AA	6 PK 2100
4593823AA	6 PK 1740
4612018	6 PK 2490
4612229	4 PK 850
4612411	6 PK 2510
4612418	6 PK 2490
4612460	6 PK 2510
4612468	4 PK 905
4612470	6 PK 1420
4612669	6 PK 1045
4612716	7 PK 1400
4612716AB	7 PK 1400
4612828	6 PK 2510
4612829	6 PK 2075
4612830	6 PK 2510
4612928	6 PK 2490
4621844	ZRK 1584
46510592	5 PK 790
46510606	3 PK 960
46510626F	6 PK 1420
46510641F	6 PK 1910
4663182	4 PK 900

**CADILLAC**

120576447	4 PK 962
-----------	----------





Teilenummer Part number	Abmessung Dimension
----------------------------	------------------------

Teilenummer Part number	Abmessung Dimension
----------------------------	------------------------

Teilenummer Part number	Abmessung Dimension
----------------------------	------------------------

**CHRYSLER**

4663199	6 PK 1370
4668180	4 PK 890
4668249AB	4 PK 1125
4668249AC	4 PK 1125
4668303	4 PK 980
4668324	6 PK 1432
4668380AC	4 PK 875
4668382AB	4 PK 1415
4668444AB	4 PK 1290
4668452AB	6 PK 1445
4668454AB	6 PK 894
4723345	5 PK 790
4751649	6 PK 1370
4751659	4 PK 900
4763863	7 PK 1970
4763863AB	7 PK 1970
4792070	6 PK 1570
4792070AC	6 PK 1570
4792071	6 PK 1060
4792071AB	6 PK 1060
4792394AA	6 PK 1345
4792408AA	4 PK 985
4792746AB	6 PK 1345
4798388	6 PK 2510
4841734AA	6 PK 1420
4861017	6 PK 1015
4861322	6 PK 2460
4861322AB	6 PK 2460
4861400	6 PK 1420
4861401	4 PK 905
4861733AC	6 PK 1250
4861734AA	6 PK 1420
4861735AA	4 EPK 906
4863835	3 PK 960
4891505AB	6 PK 1440
4891506AB	6 PK 884
4891506AC	6 PK 884
4891587AA	7 PK 2035
4891704AA	6 PK 1190
4891875AA	6 PK 1760
4892444AA	4 PK 900
4892680AA	6 PK 2130
4892747AA	4 PK 985
4892748AA	6 PK 1400
4892749AA	4 PK 900
4892749AB	4 PK 900
4892750AA	6 PK 1400
4892840AA	6 PK 2100
5015593	6 PK 2055
5037542AA	6 PK 2075
5066931AA	6 PK 1420
5066932AA	4 EPK 906
5080313AB	6 PK 1600
5086571AA	6 PK 1570
5096317AA	4 PK 890
5097758AA	6 PK 2390
5281111	6 PK 2510
5281140	6 PK 2075
5281276	6 PK 2460
53032817AB	6 PK 2205
68001143AA	ZRK 1468
68001309AA	ZRK 1468
B0013431	AVX 10 x 1090
B0015386	AVX 10 x 965
B0015387	AVX 10 x 965

**CHRYSLER**

B0017465	AVX 13 x 1175
B4040382	4 PK 980
B4040410	4 PK 1040
B4040412	4 PK 1050
B4050715	5 PK 1815
MB938467	4 PK 890
MD030605	925ST
MD308989	5 PK 1500
MN158101	6 PK 1195
MN158102	4 PK 905
MN187017	4 PK 905
MN195135	5 PK 1370
T0663544	ZRK 1261
T0722452	625ST

**CITROËN**

0000081658	ZRK 1262
00000816A6	ZRK 1445
0000128119	551UR
051361	281ST
0816.89	ZRK 1703
0816.A0	ZRK 1703
081622	ZRK 1262
081640	ZRK 1137
081654	ZRK 1144
081655	ZRK 1110
081656	ZRK 1114
081658	ZRK 1262
081663	ZRK 1254
081672	ZRK 1262
081673	ZRK 1029
081679	ZRK 1244
081685	ZRK 1537
081686	ZRK 1457
081688	ZRK 1078
081693	ZRK 1351
081698	ZRK 1029
0816A1	ZRK 1149
0816A3	ZRK 1316
0816A4	ZRK 1332
0816A6	ZRK 1445
0816C1	ZRK 1078
0816C2	ZRK 1149
0816C8	ZRK 1068
0816E0	ZRK 1537
0816E2	ZRK 1460
0816E4	ZRK 1441
0816E5	ZRK 1312
0816E7	ZRK 1441
0816F0	ZRK 1467
0816F2	ZRK 1457
0816F4	ZRK 1149
0816F7	ZRK 1453
0816G1	ZRK 1456
0816G3	ZRK 1452
0816G4	ZRK 1588
0816G7	ZRK 1460
0816G8	ZRK 1705
0816H3	ZRK 1703
0816H5	ZRK 1705
0816H6	ZRK 1537
0816H7	ZRK 1537
0816J5	ZRK 1575
0816J6	ZRK 1460
0816K0	ZRK 1592

**CITROËN**

0816K5	ZRK 1592
0816K8	ZRK 1592
081817	289UT
081819	275ST
081820	279ST
081821	350ST
081823	359UT
081832	359UT
082053	252ST
082910	614ST
082911	284ST
082912	256ST
082917	350ST
082919	252ST
082920	260ST
082921	284ST
082922	270ST
082930	254ST
082931	273ST
082932	283ST
082933	274ST
082935	283ST
082942	260ST
082943	270ST
082945	254ST
082946	273ST
082949	227UT
082952	240ST
082954	252ST
082959	437ST
082960	250UT
082961	250UT
082962	250UT
082963	250UT
082966	294ST
082967	294ST
082969	239ST
082974	240ST
082976	294ST
082977	294ST
082978	239ST
082979	239ST
082982	226ST
082988	331ST
082989	331ST
082990	345ST
082992	294ST
082993	294ST
082996	294ST
0829A0	333ST
0829A1	334UT
0829A3	447ST
0829A4	447ST
0829A7	294ST
0829C3	431ST
0829C4	432UT
0829C7	226ST
0829C8	333ST
083002	262UT
083011	255UT
083012	280UT
083013	277UT
083014	255UT
083016	255UT
083020	225UT



Teilenummer Part number	Abmessung Dimension	Teilenummer Part number	Abmessung Dimension	Teilenummer Part number	Abmessung Dimension
<b>CITROËN</b>		<b>CITROËN</b>		<b>CITROËN</b>	
083023	241UT	083180	KT 1328	5430452	AVX 10 x 825
083028	293UT	083181	KT 1328	5430452C	AVX 10 x 825
083029	293UT	083182	KT 1327	5434219Y	AVX 10 x 864
083030	293UT	083183	KT 1327	5440191	AVX 10 x 800
083031	293UT	083184	KT 1398	5440777	AVX 10 x 950
083032	357ST	083185	KT 1398	5445114	AVX 10 x 600
083036	255UT	083186	KT 1370	5445114X	AVX 10 x 600
083037	255UT	083187	KT 1370	5450L0	6 PK 1115
083040	359UT	083188	KT 1244	5489380	269SR
083042	295UT	083189	KT 1244	5490426	AVX 10 x 675
083044	241UT	083191	KT 1353	5490500	AVX 10 x 850
083046	384UT	083193	KT 1244	5490500Y	AVX 10 x 864
083048	332UT	0831K0	KT 1428	5490590	282SR
083049	332UT	0831K2	KT 1244	5490803S	AVX 10 x 725
083050	448UT	0831K7	KT 1415	5490809	AVX 10 x 785
083061	225UT	0831K9	KT 1417	5490814L	AVX 10 x 838
083062	334UT	0831L1	KT 1331	5491190	269SR
083063	384UT	0831L3	KT 1332	5491191J	AVX 10 x 725
083101	KT 1057	0831L5	KT 1521	5491218C	AVX 10 x 850
083102	KT 1013	0831L7	KT 1330	5492684	AVX 10 x 838
083103	KT 1019	0831N2	KT 1433	575027	6 PK 1751
083104	KT 1058	0831N3	KT 1433	575098	6 PK 1070
083106	KT 1068	0831N5	KT 1518	5750A1	6 PK 1660
083108	KT 1162	0831P2	KT 1390	5750A2	6 PK 1078
083111	KT 1070	0831Q4	KT 1019	5750C9	6 PK 1145
083113	KT 1013	0831R1	KT 1068	5750D1	5 PK 1190
083114	KT 1019	0831R7	KT 1433	5750D3	5 PK 715
083116	KT 1026	0831R8	KT 1327	5750D8	5 PK 690
083117	KT 1068	0831S1	KT 1398	5750D9	6 PK 913
083128	KT 1063	0831S2	KT 1351	5750E2	6 PK 1100
083131	KT 1040	0831S6	KT 1522	5750E5	6 PK 730
083132	KT 1216	0831S7	KT 1309	5750EK	6 PK 1710
083133	KT 1216	0831T4	KT 1244	5750EM	6 PK 1470
083134	KT 1522	0831V0	KT 1521	5750ET	6 PK 1190
083135	KT 1522	0831V3	KT 1518	5750EV	6 PK 1710
083137	KT 1083	11713	AVX 10 x 675	5750EW	6 PK 1580
083140	KT 1327	128019	5 PK 925	5750EY	6 PK 1440
083141	KT 1327	128027	4 PK 855	5750F0	6 PK 1700
083144	KT 1058	128028	4 PK 950	5750FC	6 PK 1725
083145	KT 1058	128034	6 PK 894	5750FF	6 PK 745
083146	KT 1084	128036	4 PK 905	5750FG	6 PK 1190
083147	KT 1084	128038	3 PK 866	5750FJ	6 PK 1205
083148	KT 1216	128039	3 PK 866	5750FR	5 PK 1219
083149	KT 1216	128040	3 PK 945	5750FT	6 PK 800
083150	KT 1071	128041	3 PK 945	5750FW	6 PK 975
083151	KT 1071	128044	6 PK 913	5750G8	4 PK 698
083153	KT 1070	128047	6 PK 995	5750G9	4 PK 813
083155	KT 1244	128051	6 PK 950	5750GC	6 PK 730
083156	KT 1309	128063	3 PK 945	5750GE	6 PK 1125
083157	KT 1309	128065	6 PK 950	5750GF	6 PK 1748
083158	KT 1433	128066	6 PK 913	5750GH	6 PK 1185
083159	KT 1433	128067	6 PK 995	5750GJ	6 PK 1390
083161	KT 1350	128117	268SR	5750GK	6 PK 1740
083162	KT 1327	128118	552UR	5750GX	6 PK 1153
083164	KT 1310	128119	551UR	5750GZ	6 PK 1560
083165	KT 1244	128139	552UR	5750H1	4 PK 954
083166	KT 1244	26207509	350ST	5750H2	4 PK 1245
083167	KT 1309	2N2316	AVX 10 x 950	5750H3	5 PK 698
083168	KT 1309	2N39118	AVX 10 x 800	5750H4	5 PK 715
083173	KT 1351	4007CV	5 PK 860	5750H5	5 PK 850
083174	KT 1351	4009P2	4 EPK 922	5750H7	5 PK 1165
083176	KT 1373	4009Q4	4 EPK 922	5750H8	6 PK 698
083177	KT 1373	5414408	AVX 10 x 975	5750H9	6 PK 730
083178	KT 1518	5414629N	AVX 10 x 1175	5750HE	6 PK 1675
083179	KT 1518	5427290H	AVX 10 x 775	5750HH	6 PK 1748

Teilenummer Part number	Abmessung Dimension	Teilenummer Part number	Abmessung Dimension	Teilenummer Part number	Abmessung Dimension
<b>CITROËN</b>		<b>CITROËN</b>		<b>CITROËN</b>	
5750J0	6 PK 800	5750RX	6 PK 1352	5750Y2	6 PK 1205
5750J1	6 PK 913	5750RZ	6 PK 1205	5750Y3	6 PK 1725
5750J2	6 PK 1010	5750S2	6 PK 865	5750Y4	6 PK 1565
5750J3	6 PK 1078	5750S4	6 PK 1025	5750YA	6 PK 1710
5750J4	6 PK 1100	5750S6	6 PK 1390	5750YC	6 PK 1450
5750J5	6 PK 1130	5750SA	6 EPK 780	5750YF	6 PK 1735
5750J6	6 PK 1145	5750SE	5 PK 880	5750YH	6 PK 1670
5750J7	6 PK 1660	5750SF	5 PK 860	5750YJ	6 EPK 1090
5750J8	6 PK 1700	5750SJ	5 PK 830	5750YK	6 EPK 780
5750K3	5 PK 775	5750SQ	4 PK 698	5750YP	6 PK 800
5750K5	5 PK 962	5750SW	5 PK 1270	5750YQ	6 PK 975
5750K6	6 PK 1863	5750SZ	5 PK 710	5750YS	6 PK 975
5750K8	6 PK 1070	5750T0	6 PK 1625	5750YX	6 PK 1245
5750KT	6 PK 1710	5750T4	5 PK 830	5750Z1	6 PK 1450
5750KV	6 PK 1345	5750T6	6 PK 1450	5750Z3	6 PK 1565
5750L0	6 PK 1115	5750T8	6 PK 1740	5750Z5	6 PK 1735
5750L2	6 PK 1740	5750TA	5 PK 1125	5750Z7	6 PK 1751
5750L4	6 PK 1153	5750TF	6 PK 1100	5750Z9	6 PK 1440
5750LA	6 PK 1470	5750TJ	6 PK 698	5750ZF	6 PK 800
5750LH	6 PK 1710	5750TK	6 PK 1130	5750ZG	6 PK 1205
5750M0	6 PK 1205	5750TN	6 PK 1175	5750ZH	6 PK 1700
5750M2	6 PK 1650	5750TT	5 PK 1255	575108	553UR
5750M3	6 PK 1190	5750TW	5 PK 715	575111	553UR
5750M5	6 PK 1105	5750TX	5 PK 690	575112	271UR
5750M7	6 PK 1725	5750V0	4 PK 860	575114	553UR
5750M9	6 PK 1165	5750VA	6 PK 1010	575115	251SR
5750P1	4 PK 755	5750VE	6 PK 1580	575118	278SR
5750P2	6 PK 1710	5750VF	6 PK 1440	575126	276SR
5750P6	5 PK 715	5750VG	6 PK 1725	575138	251SR
5750P8	5 PK 1030	5750VJ	6 PK 1190	575147	554UT
5750P9	5 PK 775	5750VK	5 PK 1219	575184	554UT
5750PC	6 PK 1145	5750VL	6 PK 800	575191	554UT
5750PF	6 PK 1000	5750VP	6 PK 1345	5M5Q6C301B	6 PK 1090
5750PG	6 PK 1215	5750VR	6 PK 1185	6453AC	5 PK 1030
5750PN	6 PK 1055	5750VX	6 PK 1748	6453AE	5 PK 1025
5750PQ	6 PK 1070	5750VY	6 PK 1700	6453C5	253SR
5750PT	6 PK 1885	5750W0	6 PK 1735	6453C6	263SR
5750PY	6 PK 1675	5750W2	6 PK 1045	6453CV	5 PK 1104
5750Q0	5 PK 775	5750W3	6 PK 1751	6453CY	5 PK 1030
5750Q1	5 PK 1055	5750W9	5 PK 775	6453FK	5 PK 1104
5750Q2	5 PK 1055	5750WA	5 PK 775	6453G4	253SR
5750Q6	6 PK 1625	5750WC	5 PK 962	6453TT	4 EPK 1102
5750Q7	5 PK 880	5750WF	6 PK 1115	6453VA	6 PK 925
5750Q9	4 PK 855	5750WG	6 PK 1560	6453W0	6 PK 925
5750QH	6 PK 962	5750WN	6 PK 730	70816E0	ZRK 1537
5750QK	6 PK 850	5750WP	6 PK 1710	70816E0134X	ZRK 1537
5750QN	6 PK 1210	5750WR	6 PK 1105	75292376	AVX 10 x 613
5750QT	6 PK 1185	5750WS	6 PK 1725	75490293	AVX 10 x 825
5750QV	6 PK 1590	5750WT	4 PK 755	75490809	AVX 10 x 775
5750QY	6 EPK 1090	5750WY	6 PK 1055	75491758	AVX 10 x 700
5750R0	5 PK 1255	5750WZ	6 PK 1070	75491768	AVX 10 x 700
5750R1	5 PK 805	5750X4	6 PK 865	75491898	AVX 10 x 850
5750R2	6 PK 1605	5750X6	6 PK 1390	75491923	268SR
5750R5	6 PK 1735	5750X7	6 PK 1735	75492161	AVX 10 x 850
5750R8	6 PK 1625	5750X8	6 PK 1470	75492300	AVX 10 x 838
5750R9	6 PK 1740	5750XA	6 PK 1565	75492376	AVX 10 x 613
5750RE	6 PK 1215	5750XC	6 PK 1885	75492514	AVX 10 x 613
5750RF	6 PK 1565	5750XF	6 PK 962	75492515	AVX 10 x 775
5750RG	6 PK 906	5750XG	6 PK 1000	75492554	AVX 10 x 600
5750RH	6 PK 1700	5750XK	6 PK 1590	75492684	AVX 10 x 838
5750RK	6 PK 870	5750XN	6 PK 1215	75515868	268SR
5750RN	6 PK 1670	5750XP	6 EPK 873	75519264	AVX 10 x 725
5750RR	6 PK 1710	5750XR	6 PK 1710	75519754	AVX 10 x 613
5750RT	6 PK 1165	5750XT	6 PK 1470	75524245	AVX 10 x 825
5750RW	6 EPK 1090	5750XY	5 PK 775	7618111	5 PK 925



Teilenummer Part number	Abmessung Dimension
----------------------------	------------------------

Teilenummer Part number	Abmessung Dimension
----------------------------	------------------------

Teilenummer Part number	Abmessung Dimension
----------------------------	------------------------

**CITROËN**

7700618657	ZRK 1051
7700718836	ZRK 1131
7700729580	ZRK 1129
816A6	ZRK 1445
90538288	5 PK 715
91001158	4 PK 1245
91506949	AVX 10 x 925
91508298	256ST
91508762	4 PK 954
9151159780	AVX 10 x 635
91512961	ZRK 1125
9151351780	ZRK 1125
9151357980	ZRK 1125
91516768	4 PK 841
91517722	ZRK 1125
9151772280	ZRK 1125
91522116	AVX 10 x 913
91535268	AVX 10 x 775
91536222	4 PK 698
91536224	4 PK 841
91536227	4 PK 1020
91536229	4 PK 1245
91536297	AVX 10 x 600
91536298	AVX 10 x 625
91536303	AVX 10 x 800
91536308	AVX 10 x 1000
91536311	AVX 10 x 1085
91536338	AVX 10 x 710
91536703	4 PK 954
91538177	5 PK 715
91538722	260ST
9154055780	ZRK 1137
91541144	5 PK 725
91541175	5 PK 725
91541176	5 PK 1015
91541177	4 PK 795
91541178	4 PK 1230
91541179	5 PK 1230
91541318	ZRK 1137
93010362	ZRK 1262
9301036280	ZRK 1262
93010364	ZRK 1262
93013132	ZRK 1143
93501082	5 PK 970
93501404	284ST
93501405	262UT
93501676	4 PK 698
9350226880	4 PK 985
93502487	4 PK 698
93502642	5 PK 970
93510091	ZRK 1262
93510847	263SR
94560702	ZRK 1114
95005666	5 PK 690
95006057	271UR
95006268	5 PK 1125
95006782	AVX 10 x 1025
95449870	AVX 10 x 838
95492684	AVX 10 x 838
95492927	AVX 10 x 625
95493061	AVX 10 x 675
95493366	AVX 10 x 838
95493420	AVX 10 x 1150
95493421	AVX 10 x 913
95493443	AVX 10 x 1150

**CITROËN**

95493868	AVX 10 x 825
95493869	AVX 10 x 825
95493870	AVX 10 x 838
95493977	ZRK 1274
95494186	AVX 10 x 825
95494188	AVX 10 x 825
95495339	AVX 10 x 635
95495480	AVX 10 x 635
95495585	AVX 10 x 775
95495830	289UT
95496822	AVX 10 x 625
95496836	AVX 10 x 625
95496878	ZRK 1096
95496894	AVX 10 x 650
95496930	AVX 10 x 775
95554802	ZRK 1274
95577539	ZRK 1096
95577540	289UT
95590353	257SK
956003380	ZRK 1096
95612377	4 PK 755
95619217	350ST
95640195	254ST
9564019580	ZRK 1142
9564026980	ZRK 1142
9564040580	ZRK 1142
95640434	5 PK 690
95661735	4 PK 813
95666985	4 PK 1020
96001122	4 PK 698
96001123	4 PK 954
96004619	253SR
96010219	5 PK 1140
96010220	5 PK 710
96010657	270ST
96011188	4 PK 813
96014241	5 PK 1270
96019294	4 PK 855
96019295	4 PK 855
96021924	5 PK 698
96021925	5 PK 698
96027231	AVX 10 x 700
96029000	ZRK 1114
96030324	4 PK 1245
96031400	5 PK 735
96031955	AVX 10 x 1110
96033798	ZRK 1118
96035624	AVX 10 x 650
96036288	551UR
96046090	5 PK 850
96046092	5 PK 850
96046101	5 PK 1390
96046105	5 PK 1390
96046630	4 PK 1265
96049648	ZRK 1144
9605284780	ZRK 1138
96053938	5 PK 1165
96056183	275ST
96056833	5 PK 1165
96056835	5 PK 735
96059322	5 PK 690
96059324	5 PK 710
96059540	5 PK 1450
96059541	5 PK 1450
96074514	251SR

**CITROËN**

96076190	552UR
96088591	278SR
96088735	ZRK 1110
96094102	280UT
96097062	ZRK 1118
96097691	281ST
96098279	279ST
96099089	255UT
96100158	ZRK 1128
96101064	ZRK 1138
96112418	253SR
96112753	553UR
96117374	4 PK 813
96120257	6 PK 913
96126957	5 PK 1025
96129654	5 PK 1255
96129662	5 PK 880
96129664	5 PK 1250
9612966480	5 PK 1255
96135989	4 PK 950
96137001	273ST
96138810	4 PK 855
96140147	ZRK 1114
96140606	6 PK 1863
96141369	ZRK 1128
96142525	ZRK 1262
96142839	6 PK 698
96144504	6 PK 730
96144507	6 PK 730
96144509	6 PK 1130
96144510	6 PK 1130
96144511	6 PK 1175
96146660	553UR
96152078	6 PK 1660
96152079	6 PK 1660
96152080	6 PK 698
96152082	6 PK 1070
96152083	6 PK 1070
96152084	6 PK 1078
96152085	6 PK 1078
96152088	6 PK 1100
96152090	5 PK 1155
96152091	5 PK 1155
96154391	6 PK 800
96155010	6 PK 1010
96155377	5 PK 880
96155378	5 PK 805
96155379	5 PK 1255
96155380	5 PK 1025
96155949	6 PK 1700
96155951	6 PK 1700
96156400	276SR
96159233	277UT
96161326	5 PK 1450
96161327	5 PK 1390
96161329	5 PK 850
96163410	5 PK 690
96165811	5 PK 775
96171886	274ST
9617800980	225UT
96183873	5 PK 1190
96188881	6 PK 1740
96192361	241UT
96197629	ZRK 1537
9619779380	ZRK 1128



Teilenummer Part number	Abmessung Dimension
----------------------------	------------------------

Teilenummer Part number	Abmessung Dimension
----------------------------	------------------------

Teilenummer Part number	Abmessung Dimension
----------------------------	------------------------

**CITROËN**

96197874	ZRK 1029
96200344	ZRK 1029
96201309	255UT
96209044	6 PK 1740
96211951	6 PK 1700
9621203380	227UT
9622313180	ZRK 1351
9622315380	ZRK 1351
96225744	283ST
96229218	3 PK 945
9623549880	6 PK 1725
9623549980	6 PK 1105
96236952	6 PK 1605
96236953	6 PK 1650
96236954	6 PK 1650
9624542280	6 PK 1205
9624542980	6 PK 1725
9624543180	6 PK 1205
96261720	5 PK 1055
96267902	6 PK 1390
96273679	5 PK 715
96273681	5 PK 775
96278607	251SR
96278805	240ST
96287933	5 PK 1025
96289902	554UT
96294081	6 PK 1625
96294858	6 PK 865
96295878	6 PK 1751
96296777	250UT
96300343	6 PK 1625
96308935	6 PK 1751
9631203080	ZRK 1457
96315206	5 PK 830
9631718780	6 PK 1725
96327221	295UT
9633010980	6 PK 1735
96334782	6 PK 1470
9633478280	6 PK 1470
9633713380	ZRK 1467
96337272	6 PK 1450
9634087880	225UT
9634106180	ZRK 1456
9634740180	ZRK 1456
96353368	239ST
9635438380	ZRK 1068
96370580	239ST
96372505	6 PK 1470
96374926	226ST
9637492680	226ST
96375140	ZRK 1445
96378749	294ST
9637914380	ZRK 1537
9638007780	6 PK 1565
9638027180	6 PK 1580
9638115380	250UT
9638355980	ZRK 1453
96398222	294ST
9639842180	ZRK 1537
96403456	294ST
9640419580	ZRK 1453
9640669280	ZRK 1441
9640810680	ZRK 1441
9640828480	447ST
9640828680	ZRK 1452

**CITROËN**

96413140	331ST
96415393	332UT
96420067	554UT
9642006780	554UT
9642574680	6 PK 1748
9642697380	6 PK 1145
96429298	345ST
96433296	294ST
9643903780	4 PK 860
9644351580	6 PK 1740
9645583280	6 PK 1390
9645717480	ZRK 1460
9645717580	ZRK 1460
9646864480	ZRK 1705
9647367480	ZRK 1588
9648473280	334UT
9648704380	333ST
9651255780	6 PK 1565
9651695680	6 PK 1885
9651765080	6 PK 1725
9652066680	431ST
965206680	431ST
9652148780	432UT
9652258880	6 PK 1748
9652746780	6 PK 1748
9653204180	6 PK 1000
9653226080	ZRK 1441
9653226280	ZRK 1441
9653319680	6 PK 1055
9653319780	6 PK 1070
9654114480	6 PK 1710
9655253580	432UT
9655253680	431ST
9656444980	6 PK 1138
9662187580	ZRK 1575
9662187680	ZRK 1575
9663100880	6 EPK 780
96654092	275ST
9672966580	ZRK 1592
9674247880	ZRK 1592
96817523	6 PK 1245
9681752380	6 PK 1245
9687911580	ZRK 1592
97522886	252ST
97522930	ZRK 1114
97532676	ZRK 1114
9753267680	ZRK 1114
97535002	252ST
AK53217	AVX 10 x 775
AM53217	AVX 10 x 800
AM53217A	AVX 10 x 775
AY53217	AVX 10 x 763
D2316	AVX 13 x 950
DD39118	AVX 10 x 800
DF39118	AVX 10 x 750
DM2316	AVX 10 x 950
DS2316	AVX 10 x 913
DS31410	AVX 10 x 550
DX231213A	AVX 10 x 975
DX2316A	AVX 10 x 990
DX2316D	AVX 10 x 975
DX31410	AVX 10 x 600
GX1110101A	AVX 10 x 613
GX1110701A	AVX 10 x 625
HG2316A	AVX 10 x 1100

**CITROËN**

HY2316	AVX 10 x 1275
HY2336B	AVX 10 x 1275

**CITROEN/PEUGEOT**

083154	KT 1244
--------	---------

**COMMER**

007005	AVX 13 x 1200
007005	AVX 13 x 1200 TM
007007	AVX 10 x 660
0070070	AVX 13 x 1150
0070070	AVX 13 x 1150 TM
0070087	AVX 13 x 1075 TM
0070100	AVX 13 x 1150
0070100	AVX 13 x 1150 TM
0070105	AVX 13 x 1200
0070105	AVX 13 x 1200 TM
0070108	AVX 13 x 1250
0070108	AVX 13 x 1250 TM
0070113	AVX 13 x 1375
0070113	AVX 13 x 1375 TM
007014	AVX 13 x 1225
007014	AVX 13 x 1225 TM
0070168	AVX 13 x 975
0070168	AVX 13 x 975 TM
007017	AVX 13 x 975
007017	AVX 13 x 975 TM
007019	AVX 13 x 1025
007019	AVX 13 x 1025 TM
007020	AVX 10 x 960
007022	AVX 13 x 1300
007022	AVX 13 x 1300 TM
007026	AVX 10 x 1000
007027	AVX 10 x 710
007032	AVX 13 x 1500
007032	AVX 13 x 1500 TM
007033	AVX 10 x 1175
007042	AVX 13 x 1450
007042	AVX 13 x 1450 TM
007217	AVX 13 x 1350 TM
007232	AVX 13 x 1275
007232	AVX 13 x 1275 TM
007233	AVX 13 x 1350 TM
007234	AVX 13 x 1250
007234	AVX 13 x 1250 TM
007237	AVX 13 x 1275
007237	AVX 13 x 1275 TM
1200156	AVX 13 x 975
1200156	AVX 13 x 975 TM
1201003	AVX 13 x 750
1201003	AVX 13 x 750 TM
1201119	AVX 13 x 950
1201119	AVX 13 x 950 TM
1203235	AVX 10 x 1025
1203758	AVX 13 x 1000
1203758	AVX 13 x 1000 TM
1208014	AVX 13 x 975
1208014	AVX 13 x 975 TM
1208742	AVX 13 x 1125
1208742	AVX 13 x 1125 TM
1208814	AVX 13 x 975
1208814	AVX 13 x 975 TM
1214758	AVX 10 x 950
1218309	AVX 10 x 925
1235180	AVX 10 x 950





Teilenummer Part number	Abmessung Dimension
----------------------------	------------------------

Teilenummer Part number	Abmessung Dimension
----------------------------	------------------------

Teilenummer Part number	Abmessung Dimension
----------------------------	------------------------

**COMMER**

1235194	AVX 10 x 1050
1238402	AVX 10 x 975
1238517	AVX 10 x 1175
1800867	AVX 13 x 1350 TM
204674	AVX 13 x 1075 TM
2612074	AVX 10 x 1425
2612075	AVX 10 x 1425
2612076	AVX 10 x 1425
2612354	AVX 13 x 750
2612354	AVX 13 x 750 TM
2612374	AVX 13 x 1275
2612374	AVX 13 x 1275 TM
2612375	AVX 13 x 1325
2612375	AVX 13 x 1325 TM
2612379	AVX 13 x 1350 TM
2612407	AVX 13 x 1050
2612407	AVX 13 x 1050 TM
2612418	AVX 13 x 1200
2612418	AVX 13 x 1200 TM
2612419	AVX 13 x 1200
2612419	AVX 13 x 1200 TM
2612421	AVX 13 x 1500
2612421	AVX 13 x 1500 TM
2612422	AVX 13 x 1275
2612422	AVX 13 x 1275 TM
2612424	AVX 13 x 1300
2612424	AVX 13 x 1300 TM
2612426	AVX 13 x 1300
2612426	AVX 13 x 1300 TM
2612428	AVX 13 x 1325
2612428	AVX 13 x 1325 TM
2612437	AVX 10 x 1425
2612440	AVX 13 x 1475
2612440	AVX 13 x 1475 TM
2612441	AVX 13 x 1500
2612441	AVX 13 x 1500 TM
2612465	AVX 13 x 1325
2612465	AVX 13 x 1325 TM
2612466	AVX 13 x 1350 TM
2612469	AVX 13 x 1325
2612469	AVX 13 x 1325 TM
2612826	AVX 10 x 1125
2612827	AVX 10 x 1150
262412	AVX 13 x 1100 TM
3024906	AVX 10 x 1025
3052279	AVX 13 x 1225
3052279	AVX 13 x 1225 TM
5031873	AVX 13 x 1125
5031873	AVX 13 x 1125 TM
5033885	AVX 13 x 1350 TM
5034622	AVX 13 x 1200
5034622	AVX 13 x 1200 TM
5035120	AVX 10 x 1125
5035143	AVX 13 x 1350 TM
5200976	AVX 10 x 1275
71803371	AVX 13 x 1350 TM
71803562	AVX 13 x 1325
71803562	AVX 13 x 1325 TM
71804203	AVX 13 x 1475
71804203	AVX 13 x 1475 TM
75243715	AVX 13 x 1225
75243715	AVX 13 x 1225 TM
J212492	AVX 13 x 1075 TM
J213567	AVX 13 x 1075 TM
P102775	AVX 10 x 1275

**COMMER**

P102872	AVX 10 x 1275
P103652	AVX 10 x 935
P104897	AVX 10 x 1140
P112039	AVX 10 x 730
W15151	AVX 10 x 950
W16896A	AVX 13 x 1325
W16896A	AVX 13 x 1325 TM

**DACIA**

6001543512	3 PK 715
6001548021	4 PK 715
7700111671	5 PK 1750
7700273650	ZRK 1317
7701472725	KT 1128
7701477024	KT 1128
8200020924	5 PK 1130
8200041848	3 PK 750
8200061673	5 PK 1110
8200211651	4 PK 715
8200243021	6 PK 1205
8200356268	6 PK 1820
8200537021	ZRK 1317
8200821813	6 PK 1205
8200821816	6 PK 1130
8200833541	5 PK 1750
8200841132	5 PK 1110

**DAEWOO**

09128725	ZRK 1023
1276178B00	ZRK 1203
5094008601	417ST
90231883	ZRK 1016
90353176	510ST
90499401	510ST
9128738	509UT
9157004	515ST
91580003	518ST
92063917	ZRK 1291
92066312	ZRK 1291
96103128	ZRK 1182
96103222	416UT
96144327	5 PK 1260
96144932	5 PK 870
96144933	5 PK 970
96144934	5 PK 1005
96182007	AVX 10 x 825
96183108	6 PK 1870
96183110	6 PK 884
96183351	ZRK 1182
96183352	ZRK 1182
96183353	ZRK 1292
96239401	4 PK 913
96239408	4 PK 665
96309968	6 PK 1890
96350327	6 PK 1725
96350526	416UT
96350548	6 PK 1900
96350550	417ST
96352407	ZRK 1292
96352517	4 PK 735
96352605	6 PK 1870
96352965	ZRK 1203
96417177	ZRK 1182
96569402	4 PK 735
96570669	4 PK 715

**DAEWOO**

96570670	4 PK 665
96603461	4 PK 954
96610029	ZRK 1072
96610562	4 PK 950
96814098	ZRK 1182

**DAF**

0067664	AVX 10 x 1050
0067665	AVX 10 x 1275
0067667	AVX 13 x 1025
0067667	AVX 13 x 1025 TM
0067668	AVX 13 x 1150
0067668	AVX 13 x 1150 TM
0067669	AVX 13 x 1275
0067669	AVX 13 x 1275 TM
0067670	AVX 13 x 1300
0067670	AVX 13 x 1300 TM
0067671	AVX 13 x 1325
0067671	AVX 13 x 1325 TM
0067672	AVX 13 x 1350 TM
0067673	AVX 13 x 1375
0067673	AVX 13 x 1375 TM
0067675	AVX 13 x 1425
0067675	AVX 13 x 1425 TM
0067676	AVX 13 x 1443
0067676	AVX 13 x 1450
0067676	AVX 13 x 1450 TM
0067677	AVX 13 x 1475
0067677	AVX 13 x 1475 TM
0067679	AVX 13 x 1550
0067679	AVX 13 x 1550 TM
0067680	AVX 13 x 1575
0067680	AVX 13 x 1575 TM
0067681	AVX 13 x 1600
0067681	AVX 13 x 1600 TM
0067682	AVX 13 x 1625
0067682	AVX 13 x 1625 TM
0067683	AVX 13 x 1650
0067683	AVX 13 x 1650 TM
0067684	AVX 13 x 1675
0067684	AVX 13 x 1675 TM
0067685	AVX 13 x 1700
0067685	AVX 13 x 1700 TM
0067687	AVX 13 x 1750
0067687	AVX 13 x 1750 TM
0067690	8 PK 1400 TM
0068223	AVX 13 x 1550
0068223	AVX 13 x 1550 TM
0068229	AVX 13 x 1500
0068229	AVX 13 x 1500 TM
0069724	AVX 13 x 1060
0069724	AVX 13 x 1060 TM
0090050	2-AVX 13 x 1950 TM
0090051	2-AVX 13 x 2025 TM
0105657	AVX 13 x 1725
0107561	AVX 13 x 1350 TM
0168923	AVX 13 x 1750
0168923	AVX 13 x 1750 TM
0192144	AVX 13 x 1175
0192144	AVX 13 x 1175 TM
0192145	AVX 13 x 1150
0192145	AVX 13 x 1150 TM
0211144	AVX 13 x 1400 TM
0211749	AVX 13 x 1325
0211749	AVX 13 x 1325 TM



Teilenummer Part number	Abmessung Dimension	Teilenummer Part number	Abmessung Dimension	Teilenummer Part number	Abmessung Dimension
<b>DAF</b>		<b>DAF</b>		<b>DAF</b>	
0212253	AVX 13 x 1450	0283164	AVX 13 x 1450	1256081	AVX 13 x 1300
0212253	AVX 13 x 1450 TM	0283164	AVX 13 x 1450 TM	1256081	AVX 13 x 1300 TM
0212269	AVX 13 x 1425	0287978	AVX 13 x 1375	1256304	AVX 13 x 1400 TM
0212269	AVX 13 x 1425 TM	0287978	AVX 13 x 1375 TM	1258942	2-AVX 13 x 1450 TM
0212523	AVX 13 x 1450	0288857	AVX 13 x 1375	1264771	AVX 13 x 1500
0212523	AVX 13 x 1450 TM	0288857	AVX 13 x 1375 TM	1264771	AVX 13 x 1500 TM
0215177	AVX 13 x 1350 TM	0289362	AVX 13 x 1150	1264785	AVX 13 x 1675
0215357	AVX 13 x 1300	0289362	AVX 13 x 1150 TM	1264785	AVX 13 x 1675 TM
0215357	AVX 13 x 1300 TM	0289842	AVX 13 x 1325	1265398	AVX 13 x 1525
0215402	AVX 13 x 1375	0289842	AVX 13 x 1325 TM	1265398	AVX 13 x 1525 TM
0215402	AVX 13 x 1375 TM	0293009	AVX 13 x 1475	1278389	2-AVX 13 x 1625 TM
0215402	AVX 13 x 1575	0293009	AVX 13 x 1475 TM	1283100	2-AVX 13 x 1950 TM
0215402	AVX 13 x 1575 TM	0293027	AVX 13 x 1525	1289200	2-AVX 13 x 1625 TM
0215523	AVX 13 x 1225	0293027	AVX 13 x 1525 TM	1289204	2-AVX 13 x 1450 TM
0215523	AVX 13 x 1225 TM	0293028	AVX 13 x 1150	1289208	AVX 13 x 1075 TM
0220048	AVX 13 x 1650	0293028	AVX 13 x 1150 TM	1300098	AVX 13 x 1300
0220048	AVX 13 x 1650 TM	0295063	AVX 13 x 1025	1300098	AVX 13 x 1300 TM
0231296	AVX 13 x 975	0295063	AVX 13 x 1025 TM	1324648	AVX 13 x 1285
0231296	AVX 13 x 975 TM	0296961	AVX 13 x 1050	1333364	AVX 13 x 1225
0233564	AVX 13 x 1500	0296961	AVX 13 x 1050 TM	1333364	AVX 13 x 1225 TM
0233564	AVX 13 x 1500 TM	0360860	AVX 13 x 1550	1333734	7 PK 1705 TM
0234125	AVX 13 x 1425	0360860	AVX 13 x 1550 TM	1362337	2-AVX 13 x 1575 TM
0234125	AVX 13 x 1425 TM	0367412	2-AVX 13 x 1450 TM	1364060	7 PK 1705 TM
0234807	AVX 13 x 1650	0369467	2-AVX 13 x 1575 TM	1372669	8 PK 1910 TM
0234807	AVX 13 x 1650 TM	0371908	2-AVX 13 x 1500 TM	1376752	AVX 13 x 1225
0236631	AVX 13 x 1400 TM	0377254	AVX 13 x 1375	1376752	AVX 13 x 1225 TM
0236632	AVX 13 x 1425	0377254	AVX 13 x 1375 TM	1388100	AVX 13 x 1225
0236632	AVX 13 x 1425 TM	0378324	AVX 13 x 1250	1388100	AVX 13 x 1225 TM
0237784	AVX 13 x 1500	0378324	AVX 13 x 1250 TM	1393280	8 PK 2045 TM
0237784	AVX 13 x 1500 TM	0378724	AVX 13 x 1250	1393344	8 PK 1220 TM
0237785	AVX 13 x 1450	0378724	AVX 13 x 1250 TM	1393365	8 PK 1715 TM
0237785	AVX 13 x 1450 TM	0394661	2/12,5 x 2025	1398637	8 PK 2380 TM
0237839	AVX 13 x 1700	0394661	2-AVX 13 x 2025 TM	1425709	AVX 13 x 1000
0237839	AVX 13 x 1700 TM	0394662	2-AVX 13 x 1950 TM	1425709	AVX 13 x 1000 TM
0238670	AVX 13 x 1675	0396574	AVX 13 x 1325	1522637	2-AVX 13 x 1500 TM
0238670	AVX 13 x 1675 TM	0396574	AVX 13 x 1325 TM	211144	AVX 13 x 1400 TM
0238770	AVX 13 x 1475	0398694	AVX 13 x 1275	211749	AVX 13 x 1325
0238770	AVX 13 x 1475 TM	0398694	AVX 13 x 1275 TM	211749	AVX 13 x 1325 TM
0243341	AVX 13 x 1600	0482544	AVX 10 x 935	212253	AVX 13 x 1450
0243341	AVX 13 x 1600 TM	0490269	8 PK 1400 TM	212253	AVX 13 x 1450 TM
0243941	AVX 13 x 1575	0555461	AVX 13 x 1300	212269	AVX 13 x 1425
0243941	AVX 13 x 1575 TM	0555461	AVX 13 x 1300 TM	212269	AVX 13 x 1425 TM
0243947	AVX 13 x 1600	0589632	2/12,5 x 2025	212523	AVX 13 x 1450
0243947	AVX 13 x 1600 TM	0589632	2-AVX 13 x 2025 TM	212523	AVX 13 x 1450 TM
0247941	AVX 13 x 1575	0634077	AVX 13 x 1450	215177	AVX 13 x 1350 TM
0247941	AVX 13 x 1575 TM	0634077	AVX 13 x 1450 TM	215356	AVX 13 x 1150
0248761	AVX 13 x 1525	0655043	AVX 13 x 1475	215356	AVX 13 x 1150 TM
0248761	AVX 13 x 1525 TM	0655043	AVX 13 x 1475 TM	215357	AVX 13 x 1300
0252790	AVX 13 x 1375	0677716	AVX 13 x 1325	215357	AVX 13 x 1300 TM
0252790	AVX 13 x 1375 TM	0677716	AVX 13 x 1325 TM	215402	AVX 13 x 1375
0252807	AVX 13 x 1300	0679733	AVX 10 x 975	215402	AVX 13 x 1375 TM
0252807	AVX 13 x 1300 TM	0701363	AVX 13 x 1375	217177	AVX 13 x 1350 TM
0256063	AVX 13 x 1025	0701363	AVX 13 x 1375 TM	222022	AVX 10 x 715
0256063	AVX 13 x 1025 TM	0751360	2-AVX 13 x 1625 TM	223736	AVX 10 x 725
0265135	AVX 13 x 1225	0759749	AVX 13 x 1025	225263	AVX 10 x 925
0265135	AVX 13 x 1225 TM	0759749	AVX 13 x 1025 TM	233564	AVX 13 x 1500
0268448	AVX 13 x 1250	0894415	AVX 13 x 1075 TM	233564	AVX 13 x 1500 TM
0268448	AVX 13 x 1250 TM	106920	AVX 10 x 1225	234125	AVX 13 x 1425
0276451	AVX 13 x 1475	1208086	AVX 13 x 890	234125	AVX 13 x 1425 TM
0276451	AVX 13 x 1475 TM	1236816	AVX 13 x 1250	234807	AVX 13 x 1650
0276741	AVX 13 x 1375	1236816	AVX 13 x 1250 TM	234807	AVX 13 x 1650 TM
0276741	AVX 13 x 1375 TM	1238642	2-AVX 13 x 2025 TM	236631	AVX 13 x 1400 TM
0278044	AVX 13 x 1625	1249561	2-AVX 13 x 1625 TM	236632	AVX 13 x 1425
0278044	AVX 13 x 1625 TM	1251720	AVX 10 x 1250	236632	AVX 13 x 1425 TM
0281983	2-AVX 13 x 1950 TM	1254890	AVX 13 x 1100 TM	236633	AVX 13 x 1375



Teilenummer Part number	Abmessung Dimension
----------------------------	------------------------

Teilenummer Part number	Abmessung Dimension
----------------------------	------------------------

Teilenummer Part number	Abmessung Dimension
----------------------------	------------------------

**DAF**

236633	AVX 13 x 1375 TM
236634	AVX 13 x 1350 TM
236635	AVX 13 x 1350 TM
236636	AVX 13 x 1450
236636	AVX 13 x 1450 TM
237784	AVX 13 x 1500
237784	AVX 13 x 1500 TM
237785	AVX 13 x 1450
237785	AVX 13 x 1450 TM
237839	AVX 13 x 1700
237839	AVX 13 x 1700 TM
238770	AVX 13 x 1475
238770	AVX 13 x 1475 TM
239484	AVX 13 x 950
239484	AVX 13 x 950 TM
243341	AVX 13 x 1600
243341	AVX 13 x 1600 TM
243807	AVX 13 x 1650
243807	AVX 13 x 1650 TM
243941	AVX 13 x 1575
243941	AVX 13 x 1575 TM
243941	AVX 13 x 1600
243941	AVX 13 x 1600 TM
243947	AVX 13 x 1600
243947	AVX 13 x 1600 TM
248044	AVX 13 x 1625
248044	AVX 13 x 1625 TM
248761	AVX 13 x 1525
248761	AVX 13 x 1525 TM
3040662	6 PK 1015 TM
3040668	10 PK 1360 TM
544262	AVX 13 x 1150
544262	AVX 13 x 1150 TM
CBU1182	8 PK 1400 TM
CBU1532	8 PK 1400 TM
CBU1716	8 PK 1460 TM
LBU5146	AVX 10 x 935
POE49882	AVX 13 x 925
POE49882	AVX 13 x 925 TM

**DAIHATSU**

1356887183	ZRK 1159
135688718300	ZRK 1159
1356887184	ZRK 1159
135688718400	ZRK 1159
1356887201	ZRK 1002
1356887206	ZRK 1002
1356887708	ZRK 1155
1356888361	ZRK 1255
13568B9050	ZRK 1159
2001251100	AVX 10 x 850
2001251120	AVX 10 x 850
2611251120	AVX 10 x 900
2611251121	AVX 10 x 864
4011251100	AVX 10 x 763
4011251102	AVX 10 x 763
4201251100	AVX 10 x 940
4431887201	3 PK 735
4431887401	4 PK 1015
4431887701	3 PK 830
4431887703	3 PK 763
4431887704	3 PK 560
4436087704	3 PK 560
8845887101	4 PK 841
8845887102	4 PK 835
8845887103	4 PK 835
8845887701	5 PK 812
8845887702	5 PK 900
8845887704	4 PK 845
8845887705	4 PK 845
8845887710	4 PK 825
8845887712	4 PK 805
8845887713	4 PK 805
8859497201	4 PK 715
8859497205	4 PK 715
9004831002	3 PK 785
9004831003	4 PK 780
9004831004	4 PK 775
9004831005	5 PK 975
9004831008	4 PK 705
9004831009	4 PK 705
9004831012	4 PK 790
9004831013	4 PK 790
9004831017	4 PK 780
9004831018	4 PK 790
9004831019	4 PK 780
9004831020	4 PK 715
9004831024	4 PK 763
9004831024	AVX 10 x 875
9004831029	4 PK 1755
9004831030	4 PK 1710
9004831046	6 PK 858
9004831047	6 PK 1205
9004831048	4 PK 1470
9004831052	4 PK 1755
9004831053	4 PK 1755
9004831059	6 PK 1580
9004831064	6 PK 1880
9004831065	6 PK 1820
9004831071	6 PK 1185
9004831500	5 PK 975
9004832002	AVX 10 x 785
9004832010	AVX 10 x 875
9004832022	AVX 10 x 875
9004832024	AVX 10 x 875
9004832035	AVX 10 x 940

**DAIHATSU**

9004832036	AVX 10 x 925
9004832040	AVX 10 x 763
9004832041	AVX 10 x 785
9004832042	AVX 10 x 900
9004832044	AVX 10 x 800
9004832045	AVX 10 x 785
9004832049	AVX 10 x 800
9004832050	AVX 10 x 800
9004832051	AVX 10 x 763
9004832052	AVX 10 x 763
9004832053	AVX 10 x 775
9004832061	AVX 10 x 785
9004832063	AVX 10 x 763
9004832076	AVX 10 x 775
9004931004	4 PK 775
9086100880	AVX 13 x 875
9087009300	AVX 10 x 940
9087009400	AVX 10 x 940
9089407960	AVX 10 x 800
9091602122	3 PK 800
9194008300	4 PK 835
9400483205	AVX 10 x 775
9932100791	AVX 10 x 800
9932100870	AVX 10 x 875
9932100885	AVX 10 x 888
9932100931	AVX 10 x 930
9932100961	AVX 10 x 965
9932100966	AVX 10 x 965
9932100975	AVX 10 x 975
9932101000	AVX 10 x 1000
9932110811	AVX 10 x 813
9932150726	AVX 10 x 740
9932150761	AVX 10 x 763
9932150791	AVX 10 x 800
9932150821	AVX 10 x 825
9932150931	AVX 10 x 940
9932150951	AVX 10 x 950
9932150956	AVX 10 x 965
9932150961	AVX 10 x 960
9932150966	AVX 10 x 965
9932150975	AVX 10 x 975
9932150996	AVX 10 x 1000
9932200860	AVX 13 x 865
9932200890	AVX 13 x 900
9932200930	AVX 13 x 930
9932200950	AVX 13 x 950
9932201155	AVX 13 x 1150
9932201155	AVX 13 x 1150 TM
9932201240	AVX 13 x 1250
9933110811	AVX 10 x 813
9933110870	AVX 10 x 875
9933150640	AVX 10 x 850
9933200805	AVX 13 x 800
9933200890	AVX 13 x 900
9933201055	AVX 13 x 1055
9933210761	AVX 13 x 775
9933210786	AVX 13 x 785
9933260831	AVX 13 x 835
9933260891	AVX 13 x 900
9936400830	4 PK 835
9936450830	4 PK 835
9936470830	4 PK 835
9936480830	4 PK 835
9936500820	5 PK 820
9936500920	5 PK 920

**DAIHATSU**

135036402000	816UT
135036402100	816UT
135051504000	825ST
135051504100	825ST
1350587102	179ST
135058710200	179ST
135058730100	221UT
135058730300	220ST
135058770100	834ST
1351487206	ZRK 1002
1351487211	ZRK 1002
1351487711	ZRK 1155
1351487783	ZRK 1155
1356815010	ZRK 1034
1356887101	ZRK 1157
1356887102	ZRK 1157
1356887103	ZRK 1159
135688710300	ZRK 1159
1356887104	ZRK 1159
135688710400	ZRK 1159
1356887108	ZRK 1159
135688710800	ZRK 1159
1356887181	ZRK 1157
1356887182	ZRK 1157





Teilenummer Part number	Abmessung Dimension
----------------------------	------------------------

Teilenummer Part number	Abmessung Dimension
----------------------------	------------------------

Teilenummer Part number	Abmessung Dimension
----------------------------	------------------------

**DAIHATSU**

9936550820	5 PK 820
9952100843	AVX 10 x 850
9952100860	AVX 10 x 864
9952100870	AVX 10 x 875
9952100902	AVX 10 x 900
9952100909	AVX 10 x 900
9952100919	AVX 10 x 925
9952100929	AVX 10 x 925
9952100950	AVX 10 x 950
9952110895	AVX 10 x 900
9952110959	AVX 10 x 950
9952110969	AVX 10 x 975
9952111119	AVX 10 x 1125
9952150895	AVX 10 x 900
9952150919	AVX 10 x 925
9952150931	AVX 10 x 940
9952150959	AVX 10 x 965
9952150961	AVX 10 x 965
9952150985	AVX 10 x 990

**DATSUN**

1172059M00	AVX 13 x 850
1172069901	AVX 10 x 990
1172069920	AVX 10 x 990
1172077702	AVX 10 x 975
11720E4615	AVX 10 x 864

**DEUTZ-FAHR**

01116078	17 x 1000
01154305	AVX 13 x 1375
01154305	AVX 13 x 1375 TM
01154306	AVX 13 x 1400 TM
01154307	AVX 13 x 1450
01154307	AVX 13 x 1450 TM
01154308	AVX 13 x 1475
01154308	AVX 13 x 1475 TM
01154309	AVX 13 x 1500
01154309	AVX 13 x 1500 TM
01154310	AVX 13 x 1525
01154311	AVX 13 x 1600
01154311	AVX 13 x 1600 TM
01154312	AVX 13 x 1700
01154312	AVX 13 x 1700 TM
01154321	AVX 13 x 1400 TM
01154322	AVX 13 x 1450
01154322	AVX 13 x 1450 TM
01154324	AVX 13 x 1675
01154324	AVX 13 x 1675 TM
01154325	AVX 13 x 1700
01154325	AVX 13 x 1700 TM
01154334	AVX 10 x 1500
01154334	AVX 10 x 1500 TM
01154335	AVX 10 x 1525
01154339	AVX 10 x 600
01154348	AVX 10 x 1184
01154350	AVX 10 x 1200
01154351	AVX 13 x 850
01154352	AVX 13 x 1050
01154352	AVX 13 x 1050 TM
01154353	AVX 13 x 1075 TM
01154354	AVX 13 x 1125
01154354	AVX 13 x 1125 TM
01154357	AVX 13 x 1200
01154357	AVX 13 x 1200 TM
01154359	AVX 13 x 1475

**DEUTZ-FAHR**

01154359	AVX 13 x 1475 TM
01156921	AVX 10 x 1125
01173896	AVX 13 x 1425
01173896	AVX 13 x 1425 TM
01173898	AVX 13 x 1375
01173898	AVX 13 x 1375 TM
01174283	AVX 13 x 1325
01174283	AVX 13 x 1325 TM
01174284	AVX 13 x 1350 TM
01174612	AVX 10 x 1000
01174834	AVX 13 x 1550
01174834	AVX 13 x 1550 TM
01175719	AVX 13 x 1250
01175719	AVX 13 x 1250 TM
01175745	AVX 10 x 975
01175766	AVX 10 x 1525
01175882	AVX 10 x 1025
01175928	AVX 10 x 1050
01175929	AVX 10 x 1025
01175933	AVX 13 x 1025
01175933	AVX 13 x 1025 TM
01175939	AVX 13 x 1425
01175939	AVX 13 x 1425 TM
01175968	AVX 13 x 1250
01175968	AVX 13 x 1250 TM
01175969	AVX 13 x 1275
01175969	AVX 13 x 1275 TM
01175970	AVX 13 x 1275
01175970	AVX 13 x 1275 TM
01175974	AVX 13 x 1350 TM
01176089	AVX 10 x 1050
01176178	AVX 10 x 1250
01176304	AVX 10 x 1375
01176324	AVX 10 x 1000
01176330	AVX 13 x 1375
01176330	AVX 13 x 1375 TM
01176331	AVX 10 x 1225
01177081	AVX 13 x 1030
01177873	AVX 13 x 1250
01177873	AVX 13 x 1250 TM
01178737	AVX 13 x 1075 TM
01178738	AVX 13 x 1225
01178738	AVX 13 x 1225 TM
01178739	AVX 13 x 1325
01178739	AVX 13 x 1325 TM
01179088	AVX 13 x 1060
01179088	AVX 13 x 1060 TM
01179456	AVX 13 x 810
01179461	AVX 10 x 1125
01179474	AVX 10 x 950
01179475	AVX 10 x 1225
01179476	AVX 10 x 1300
01179477	AVX 10 x 1375
01179479	AVX 13 x 1075 TM
01179480	AVX 10 x 1375
01179529	AVX 13 x 1825
01179529	AVX 13 x 1825 TM
01179564	AVX 10 x 1175
01179565	AVX 10 x 1125
01179566	AVX 10 x 1150
01179648	AVX 10 x 825
01179650	AVX 13 x 1000
01179650	AVX 13 x 1000 TM
01179673	AVX 13 x 1400 TM
01179674	AVX 10 x 1325

**DEUTZ-FAHR**

01179675	AVX 10 x 1400
01179718	AVX 10 x 1350
01179718	AVX 10 x 1350 TM
01179720	AVX 10 x 1425
01179722	AVX 10 x 1425
01179747	AVX 10 x 1275
01179749	AVX 10 x 1350
01179749	AVX 10 x 1350 TM
01179777	AVX 10 x 975
01179779	AVX 10 x 1525
01179787	AVX 10 x 1525
01179830	AVX 13 x 1000
01179830	AVX 13 x 1000 TM
01179831	AVX 13 x 1000
01179831	AVX 13 x 1000 TM
01179852	AVX 10 x 1300
01179888	AVX 10 x 1300
01179890	AVX 13 x 1100 TM
01179978	AVX 10 x 1025
01179988	AVX 10 x 1025
01179996	AVX 10 x 1050
01180150	AVX 13 x 1200
01180150	AVX 13 x 1200 TM
01180172	AVX 13 x 1150
01180172	AVX 13 x 1150 TM
01180173	AVX 10 x 1200
01180182	AVX 13 x 1100 TM
01180194	AVX 10 x 1400
01180350	AVX 13 x 1275
01180350	AVX 13 x 1275 TM
01180434	AVX 10 x 750
01180435	AVX 13 x 1250
01180435	AVX 13 x 1250 TM
01180436	AVX 13 x 1325
01180436	AVX 13 x 1325 TM
01180437	AVX 13 x 1450
01180437	AVX 13 x 1450 TM
01180438	AVX 13 x 1475
01180438	AVX 13 x 1475 TM
01180462	AVX 10 x 785
01180464	AVX 13 x 975
01180464	AVX 13 x 975 TM
01180467	AVX 13 x 1025
01180467	AVX 13 x 1025 TM
01180468	AVX 13 x 1050
01180468	AVX 13 x 1050 TM
01180516	AVX 13 x 1300
01180516	AVX 13 x 1300 TM
01180517	AVX 13 x 1525
01180552	AVX 13 x 1225
01180552	AVX 13 x 1225 TM
01180612	AVX 13 x 1350 TM
01180619	AVX 13 x 1125
01180619	AVX 13 x 1125 TM
01180640	AVX 10 x 775
01180655	AVX 13 x 1175
01180655	AVX 13 x 1175 TM
01180663	AVX 13 x 975
01180663	AVX 13 x 975 TM
01180709	AVX 10 x 875
01180831	AVX 10 x 1250
01180846	AVX 10 x 1175
01180847	AVX 13 x 950
01180847	AVX 13 x 950 TM
01180848	AVX 13 x 1000

Teilenummer Part number	Abmessung Dimension
----------------------------	------------------------

Teilenummer Part number	Abmessung Dimension
----------------------------	------------------------

Teilenummer Part number	Abmessung Dimension
----------------------------	------------------------

**DEUTZ-FAHR**

01180901	AVX 10 x 850
01180904	AVX 13 x 1312
01180913	AVX 13 x 975
01181076	AVX 13 x 1150
01181184	AVX 10 x 1000
01181185	AVX 13 x 1175
01181185	AVX 13 x 1175 TM
01181341	AVX 13 x 1350 TM
01181587	AVX 13 x 1225
01181675	AVX 10 x 690
01181775	AVX 13 x 1025
01181775	AVX 13 x 1025 TM
01181891	2-AVX 13 x 1450 TM
02234343	AVX 10 x 1375
02235056	AVX 10 x 1500
02235056	AVX 10 x 1500 TM
02235175	AVX 10 x 1300
02235176	AVX 10 x 1350
02235176	AVX 10 x 1350 TM
02235177	AVX 10 x 1400
02235178	AVX 10 x 1100
02235179	AVX 10 x 1125
02235180	AVX 10 x 1150
02235181	AVX 10 x 1175
02235253	AVX 10 x 1075
02235253	AVX 10 x 1075 TM
02235254	AVX 10 x 1350
02235254	AVX 10 x 1350 TM
02235257	AVX 10 x 1150
02235258	AVX 10 x 1175
02235260	AVX 10 x 1300
02235262	AVX 10 x 1500
02235262	AVX 10 x 1500 TM
02235263	AVX 10 x 1525
02235373	AVX 10 x 875
02235374	AVX 10 x 900
02235377	AVX 10 x 900
02235530	AVX 10 x 1275
02235531	AVX 10 x 1275
02235532	AVX 10 x 1340
02235533	AVX 10 x 1340
02235713	AVX 10 x 950
02235714	AVX 10 x 1325
02235816	AVX 10 x 1325
02237477	AVX 10 x 975
02418962	AVX 13 x 1075 TM
02419104	AVX 13 x 975
02419104	AVX 13 x 975 TM
02419105	AVX 13 x 1025
02419105	AVX 13 x 1025 TM
02419221	AVX 13 x 1200
02419221	AVX 13 x 1200 TM
02421916	AVX 13 x 1125
02421916	AVX 13 x 1125 TM
04147300	AVX 13 x 1425
04147300	AVX 13 x 1425 TM
04147646	AVX 13 x 1050
04147646	AVX 13 x 1050 TM
04232845	AVX 10 x 1325
04343181	AVX 13 x 1300
04343181	AVX 13 x 1300 TM
04359336	AVX 13 x 1400 TM
12270923	AVX 13 x 925
12270923	AVX 13 x 925 TM
12270924	AVX 10 x 1350

**DEUTZ-FAHR**

12270924	AVX 10 x 1350 TM
12272665	AVX 13 x 1525

**DODGE**

04593665AB	6 PK 2020
04891661AA	6 PK 1718
1821643	AVX 10 x 950
2843221	AVX 13 x 1175
2843221	AVX 13 x 1175 TM
4573013AC	6 PK 1345
4593684AA	6 PK 2100
4593852AB	6 PK 2020
4612669	6 PK 1045
4612828	6 PK 2510
4668180AB	4 PK 890
4792746AB	6 PK 1345
4854258	6 PK 2020
4861322AB	6 PK 2460
4861322AC	6 PK 2460
4861400	6 PK 1420
4861401	4 PK 905
4891598AB	6 PK 2550
4891661AA	6 PK 1718
4891692AB	6 PK 2040
4891704AA	6 PK 1190
4892680AA	6 PK 2130
4892747AA	4 PK 985
4892749AA	4 PK 900
4892750AA	6 PK 1400
5103564AA	6 PK 2270
5103565AA	6 PK 2260
5281140	6 PK 2075
53013905AC	6 PK 2205
53032037AL	6 PK 2228
53032037AM	6 PK 2228
53032125AB	6 PK 2240
53032125AE	6 PK 2205
53032755AA	6 PK 2228
53032817AA	6 PK 2205
53032817AB	6 PK 2205
MD322330	4 PK 900
MD365263	5 PK 1370
MD368275	6 PK 1195
MD376691	5 PK 940

**DONGNAN (SOUEAST)**

SMD182293	ZRK 1176
-----------	----------

**ENASA**

773851	AVX 13 x 1650
773851	AVX 13 x 1650 TM
773852	AVX 13 x 1750
773852	AVX 13 x 1750 TM
773853	AVX 13 x 1100
773853	AVX 13 x 1100 TM
773855	AVX 13 x 1525
773857	AVX 13 x 1725
773858	AVX 13 x 1125
773858	AVX 13 x 1125 TM
773859	AVX 13 x 1000
773859	AVX 13 x 1000 TM
773860	AVX 13 x 975
773861	AVX 13 x 1400 TM
773862	AVX 13 x 1450
773862	AVX 13 x 1450 TM

**ENASA**

773863	AVX 13 x 1600
773863	AVX 13 x 1600 TM
773864	AVX 13 x 1625
773865	AVX 13 x 1575
773865	AVX 13 x 1575 TM
773867	AVX 13 x 950
773867	AVX 13 x 950 TM
773868	AVX 13 x 1150
773868	AVX 13 x 1150 TM

**FERRARI**

133228	5 PK 865
133262	4 PK 813
138325	5 PK 735
139449	6 PK 950
150008	5 PK 1330
156329	6 PK 1010
156708	6 PK 1000
158102	6 PK 1250
166453	5 PK 1300
201448	6 PK 1515
260292A	AVX 10 x 1075
260292A	AVX 10 x 1075 TM
260297A	AVX 10 x 950
260469A	AVX 10 x 925
260475A	AVX 10 x 838

**FIAT**

1300342080	5 PK 940
1313020080	6 PK 962
1473011080	ZRK 1127
1752164J00	5 PK 835
4025787	AVX 10 x 965
4028501	AVX 10 x 975
4028502	AVX 10 x 975
4037771	AVX 10 x 800
4042901	AVX 10 x 950
4045907	AVX 10 x 750
41118x3/4"	AVX 10 x 1275
4117293	AVX 10 x 813
4152329	ZRK 1087
4153106	AVX 10 x 735
4153107	AVX 10 x 750
4156392	AVX 10 x 800
4156930	AVX 10 x 750
4156931	AVX 10 x 800
4158857	AVX 10 x 850
4164623	AVX 10 x 785
4164887	AVX 10 x 1000
4165189	AVX 10 x 850
4166035	AVX 13 x 1550
4168467	AVX 10 x 913
4169467	AVX 10 x 913
4170927	AVX 10 x 1075
4170927	AVX 10 x 1075 TM
4171293	AVX 10 x 813
4174521	AVX 10 x 625
4176009	AVX 13 x 1250
4176009	AVX 13 x 1250 TM
4176054	AVX 13 x 1525
4176840	ZRK 1051
4181524	AVX 10 x 785
4181525	AVX 10 x 700
4182425	ZRK 1087
4182426	ZRK 1088

Teilenummer Part number	Abmessung Dimension	Teilenummer Part number	Abmessung Dimension	Teilenummer Part number	Abmessung Dimension
<b>FIAT</b>		<b>FIAT</b>		<b>FIAT</b>	
4201738	ZRK 1089	4511850	AVX 10 x 710	46429444	4 PK 705
4201739	ZRK 1089	4520320	AVX 10 x 850	46429930	6 PK 1830
4206718	AVX 10 x 1075	4537928	AVX 13 x 1300	46439000	6 PK 1105
4206718	AVX 10 x 1075 TM	4537928	AVX 13 x 1300 TM	46439824	6 PK 935
4218720	AVX 10 x 1100	4538873	AVX 10 x 1100	46443510	4 PK 780
4224377	AVX 10 x 825	4547433	AVX 13 x 1425	46444537	6 PK 1740
4225393	AVX 10 x 850	4547433	AVX 13 x 1425 TM	46446830	6 PK 1830
4229143	AVX 10 x 935	4547443	AVX 13 x 1425	46446963	4 PK 905
4229143	AVX 10 x 938	4547443	AVX 13 x 1425 TM	46448693	5 PK 940
4229144	AVX 10 x 1275	4547446	AVX 10 x 1050	46448694	4 PK 962
4229145	AVX 10 x 913	4606269	AVX 13 x 1425	46451652	4 PK 855
4242396	ZRK 1267	4606269	AVX 13 x 1425 TM	46451885	6 PK 1038
4250074	ZRK 1052	4606270	AVX 10 x 975	46451888	6 PK 1830
4279749	AVX 10 x 913	4606468	AVX 10 x 1275	4645365	AVX 10 x 975
4279749	AVX 10 x 925	4610482	AVX 10 x 975	46454225	5 PK 1025
4301066	AVX 10 x 1025	4610657	AVX 10 x 960	46456894	4 PK 962
4306859	AVX 10 x 800	4615469	AVX 10 x 1100	46457742	ZRK 1422
4306860	AVX 10 x 965	4615470	AVX 10 x 1110	4645911	AVX 13 x 1450
4306861	AVX 10 x 925	4615473	AVX 10 x 1110	4645913	AVX 13 x 1450
4306862	AVX 10 x 1275	4615474	AVX 10 x 1100	4645914	AVX 10 x 1050
4313390	AVX 10 x 825	4616155	AVX 10 x 960	4646105	AVX 13 x 1425
4320893	379UT	4616931	AVX 10 x 800	4646105	AVX 13 x 1425 TM
4320965	ZRK 1030	4617480	AVX 13 x 1300	4646107	AVX 13 x 1425
4332785	AVX 10 x 813	4617480	AVX 13 x 1300 TM	4646107	AVX 13 x 1425 TM
4335587	AVX 10 x 813	4619689	AVX 10 x 925	4646108	AVX 10 x 1050
4337104	AVX 10 x 1025	4619691	AVX 10 x 925	46462943	3 PK 668
4347067	ZRK 1030	4619695	AVX 10 x 1250	46462944	5 PK 940
4350651	AVX 10 x 1090	4619699	AVX 10 x 1250	46462949	6 PK 935
4365185	ZRK 1030	4620361	AVX 10 x 1140	46462950	6 PK 985
4367051	ZRK 1054	4624730	AVX 10 x 1100	46468650	5 PK 954
4371913	AVX 10 x 1000	4624733	AVX 10 x 960	4647062	6 PK 1840
4382104	AVX 10 x 1050	4624734	AVX 10 x 925	46471757	5 PK 954
4385150	AVX 10 x 710	4624736	AVX 10 x 1125	46473060	5 PK 954
4385583	379UT	4624737	AVX 10 x 1140	46473645	4 PK 940
4386575	376UT	4624738	AVX 10 x 1140	46474060	4 PK 750
4387012	ZRK 1031	4624745	AVX 10 x 1250	46474061	6 PK 1045
43895270	AVX 10 x 800	4625683	AVX 10 x 960	46474062	6 PK 1840
4393665	AVX 10 x 625	4625686	AVX 10 x 960	46474063	6 PK 1038
4401261	ZRK 1267	4631961	AVX 13 x 1450	46474064	6 PK 1830
4406633	ZRK 1057	4637986	AVX 10 x 1325	46474432	ZRK 1310
4406634	ZRK 1057	4638182	AVX 10 x 1110	46478610	ZRK 1244
4418465	ZRK 1030	4638401	AVX 10 x 1375	46479557	6 PK 1760
4420507	ZRK 1051	4639586	AVX 13 x 1750	4649011	AVX 10 x 1075
4427068	356ST	4639586	AVX 13 x 1750 TM	4649011	AVX 10 x 1075 TM
4438894	358ST	46400045	ZRK 1245	4650438	AVX 13 x 1300
4440806	AVX 10 x 1060	46400047	3 PK 668	4650438	AVX 13 x 1300 TM
4440806	AVX 10 x 1075	46400054	369UT	46514138	6 DPK 1225
4440806	AVX 10 x 1075 TM	46403146	4 PK 950	46514671	ZRK 1245
4442396	ZRK 1267	46403659	ZRK 1322	46516743	4 PK 905
4443446	381UT	46403679	170UT	46517850	4 PK 841
4443703	380UT	46403854	5 PK 940	46517851	4 PK 698
4448399	AVX 10 x 838	4640604	AVX 10 x 1050	46520499	6 PK 1390
4448400	AVX 10 x 838	46406340	4 PK 940	46520501	4 PK 755
4448400	AVX 10 x 844	46408751	ZRK 1244	46520502	4 PK 755
4452647	ZRK 1052	46411594	3 PK 668	46526291	ZRK 1205
4458068	AVX 10 x 864	46411595	4 PK 962	46527337	6 PK 1775
4464043	AVX 10 x 825	46412707	6 PK 925	46527552	4 PK 698
4466209	AVX 10 x 850	46413020	5 PK 975	46528833	3 PK 648
4466209	AVX 10 x 864	46416489	368ST	46533490	6 PK 1125
4467845	AVX 10 x 825	46417967	ZRK 1244	46537099	4 PK 962
4470182	AVX 10 x 888	46424623	3 PK 1000	46540546	6 PK 1038
4478580	AVX 10 x 825	46426983	ZRK 1113	46541065	ZRK 1246
4503472	AVX 10 x 710	46426983/608	ZRK 1113	46542138	5 PK 940
4503473	AVX 13 x 1050	46428896	4 PK 980	46542139	5 PK 954
4503473	AVX 13 x 1050 TM	46429443	4 PK 675	46542302	4 PK 962



Teilenummer Part number	Abmessung Dimension	Teilenummer Part number	Abmessung Dimension	Teilenummer Part number	Abmessung Dimension
<b>FIAT</b>		<b>FIAT</b>		<b>FIAT</b>	
46542303	4 PK 855	4688852	AVX 10 x 1100	504066407	4 EPK 903
46548288	ZRK 1422	4688853	AVX 10 x 1125	504076915	ZRK 1596
46548454	5 PK 1175	4688854	AVX 10 x 1140	504087247	4 EPK 1102
4654911	AVX 10 x 1075	4688854	AVX 10 x 1150	504092340	6 PK 1165
4654911	AVX 10 x 1075 TM	4688855	AVX 10 x 1140	504171190	6 PK 950
46549624	5 PK 1190	4688856	AVX 10 x 990	504171191	6 PK 995
46550322	5 PK 1590	4688857	AVX 10 x 990	504183759	449ST
46554745	4 PK 685	4688859	AVX 10 x 960	51758124	6 PK 1390
46554826	369UT	4696714	AVX 10 x 1175	51758365	6 PK 1413
46555974	6 PK 1795	4702438	AVX 10 x 1140	51758366	6 PK 1413
46556131	6 PK 1795	4705361	AVX 10 x 1125	5356125	ZRK 1309
46557131	4 PK 780	4706572	AVX 10 x 1150	5414629	AVX 10 x 1175
4660360	AVX 10 x 990	4706573	AVX 10 x 1150	5491758	AVX 10 x 700
4660361	AVX 10 x 990	4708482	AVX 13 x 1200	5492554	AVX 10 x 600
4665640	AVX 10 x 1025	4712147	AVX 10 x 1300	5494188	AVX 10 x 825
4665641	AVX 10 x 1025	4712148	AVX 10 x 1300	5495830	289UT
46736814	4 PK 665	4712149	AVX 10 x 1300	5496878	ZRK 1096
46738444	5 PK 940	4717331	AVX 13 x 1750	55182511	4 EPK 1022
46738445	3 PK 668	4717331	AVX 13 x 1750 TM	55183446	ZRK 1469
46746017	4 PK 841	4717332	AVX 13 x 1300	55183527	371ST
46747484	6 PK 1230	4717332	AVX 13 x 1300 TM	55183528	ZRK 1466
46747485	6 PK 1230	4720777	ZRK 1100	55185077	6 PK 1185
46749664	6 PK 1830	4726466	AVX 13 x 1200	55188191	ZRK 1245
46749665	6 PK 1840	4726920	AVX 10 x 1350	55189680	6 PK 1820
46750865	ZRK 1438	4732574	AVX 13 x 1025	55189686	6 PK 1740
46751187	ZRK 1322	4740846	359UT	55189689	6 PK 1760
46751200	4 PK 675	4740847	357ST	55191004	6 PK 1275
46755987	6 PK 820	4741536	372ST	55191005	6 PK 1275
46759720	6 PK 1840	4749444	AVX 13 x 1000	55191006	6 PK 1195
46770210	4 PK 675	4751143	ZRK 1102	55191315	371ST
46770217	6 PK 985	4756335	AVX 10 x 1525	55191970	5 PK 1145
46770218	3 PK 720	4756336	AVX 10 x 1525	55192075	6 PK 1038
46770219	4 PK 905	4758123	AVX 10 x 913	55192239	365ST
46770221	3 PK 685	4759595	AVX 13 x 1450	55192240	228ST
46770222	5 PK 975	4759597	AVX 13 x 1450	55192773	229ST
46770223	6 PK 935	4761774000	AVX 13 x 1525	55192799	5 PK 940
46770224	4 PK 950	4764805	AVX 10 x 1050	55192802	3 PK 668
46775098	6 PK 1138	4764807	AVX 10 x 1025	55192896	ZRK 1540
46776647	3 PK 698	4764808	AVX 10 x 1025	55193659	ZRK 1701
46780356	3 PK 698	4765100	AVX 10 x 925	55193679	6 PK 815
46780505	ZRK 1113	4776672	AVX 13 x 1475	55193795	5 PK 1145
46786740	6 PK 1775	4796327	AVX 10 x 1175	55194752	6 PK 1055
46787905	3 PK 913	4796328	AVX 10 x 1200	55196971	367ST
46787907	6 PK 1760	4796442	AVX 10 x 1325	55200252	6 PK 1395
46791187	ZRK 1747	4796650	AVX 10 x 1200	55200253	6 PK 1413
46791188	ZRK 1113	4799498	AVX 10 x 1100	55200255	6 PK 1055
46791189	ZRK 1451	4829182	AVX 13 x 925	55200441	421UT
46792898	368ST	4830920	AVX 13 x 1275	55202378	6 PK 1255
46798891	6 PK 1145	4830921	AVX 13 x 1700	55202379	6 PK 800
46801955	6 PK 1055	4834370	ZRK 1094	55202584	6 PK 800
46801957	6 PK 1820	4834880	AVX 13 x 825	55202585	6 PK 1255
46803270	6 PK 1055	4872967	AVX 10 x 1525	55202586	6 PK 1185
46803271	6 PK 1820	4888854	AVX 10 x 1140	55202621	6 PK 1318
46806144	6 PK 1090	500323627	ZRK 1316	55203784	ZRK 1701
46809420	4 PK 665	500328902	359UT	55203785	ZRK 1469
46811241	4 EPK 917	500344281	5 PK 1104	55203786	ZRK 1438
46811283	4 EPK 874	500345344	6 PK 913	55210626	ZRK 1306
46811573	6 PK 1275	500346828	6 PK 950	55216056	6 PK 1395
46817666	170UT	500371975	ZRK 1596	55218886	6 PK 1670
46818260	5 PK 1155	500385160	6 PK 995	55350419	5 PK 1450
46820062	6 PK 1185	500388408	7 PK 1080	55350421	5 PK 1545
46820063	6 PK 1310	500388688	459UT	55351458	5 PK 1030
46820063A696	6 PK 1310	504010846	449ST	55556430	5 PK 1590
4683770	AVX 10 x 1125	504012393	4 PK 985	55559175	6 PK 2120
4683771	AVX 10 x 1125	504066406	ZRK 1596	55560082	425ST



Teilenummer Part number	Abmessung Dimension	Teilenummer Part number	Abmessung Dimension	Teilenummer Part number	Abmessung Dimension
<b>FIAT</b>		<b>FIAT</b>		<b>FIAT</b>	
55562217	425ST	60667050	6 PK 1290	71738160	5 PK 954
55570289	425ST	60667257	6 PK 1820	71738161	3 PK 698
561239	AVX 13 x 1125	60671573	378UT	71739512	6 PK 1275
561239	AVX 13 x 1125 TM	60674147	6 PK 1795	71739607	4 PK 675
5619217	350ST	60676137	6 PK 1025	71739608	4 PK 705
568082	AVX 13 x 1150	60807260	ZRK 1286	71739609	4 PK 940
568082	AVX 13 x 1150 TM	60808684	5 PK 905	71739610	5 PK 962
572192	AVX 13 x 1125	60808954	7 PK 1175	71739618	5 PK 886
572192	AVX 13 x 1125 TM	60809160	5 PK 940	71739619	3 PK 685
573972	AVX 13 x 1125	60812622	365ST	71739620	6 PK 935
5889260	ZRK 1248	60812624	378UT	71739621	4 PK 950
5930833	AVX 10 x 825	60812718	228ST	71739627	ZRK 1253
5931389	AVX 10 x 1090	60813415	378UT	71739801	426UT
5931389	AVX 10 x 1100	60813590	421UT	71739873	ZRK 1455
5931889	AVX 10 x 1075	60813756	6 PK 1045	71739899	ZRK 1052
5931889	AVX 10 x 1075 TM	60814603	ZRK 1113	71739901	ZRK 1100
5933783	AVX 10 x 838	60816661	6 PK 1760	71739905	5 PK 940
5947594	AVX 10 x 838	71712149	5 PK 1055	71739910	6 PK 1751
5947596	AVX 10 x 1075	71718718	4 PK 675	71739911	5 PK 975
5947596	AVX 10 x 1075 TM	71718838	4 PK 841	71739914	7 PK 1950
5948450	AVX 10 x 1060	71719005	ZRK 1244	71739916	6 PK 1795
5949504	AVX 10 x 800	71719007	5 PK 985	71739921	6 PK 1660
5952181	360UT	71719039	4 PK 698	71739923	6 PK 1740
5952779	ZRK 1082	71719079	5 PK 925	71739924	6 PK 1740
5953873	AVX 10 x 938	71719174	4 PK 913	71739925	4 PK 780
5956109	377UT	71719394	6 PK 1840	71739928	6 PK 913
5956125	ZRK 1309	71719396	6 PK 985	71739929	6 PK 950
5966001	352ST	71719397	5 PK 954	71740485	4 PK 685
5970621	373UT	71719398	3 PK 913	71740977	350ST
5972277	350ST	71719399	3 PK 720	71742126	4 PK 805
5973343	ZRK 1053	71719400	6 PK 1138	71742127	5 PK 835
5973727	ZRK 1058	71719401	6 PK 1775	71743889	6 PK 1390
5985019	353ST	71719407	5 PK 970	71744462	6 PK 1255
5985163	ZRK 1085	71719414	3 PK 698	71744463	6 PK 800
5985207	AVX 10 x 775	71719643	ZRK 1422	71745115	6 PK 1185
5990576	AVX 10 x 888	71719644	6 PK 1055	71746353	KT 1324
5990578	5 PK 835	71719645	6 PK 1820	71746480	6 PK 815
5990649	AVX 10 x 913	71719646	ZRK 1310	71746481	6 PK 800
5990790	AVX 10 x 888	71719650	ZRK 1306	71746482	6 PK 1255
5990928	354UT	71719651	ZRK 1113	71746714	6 PK 1390
5992345	AVX 10 x 965	71719652	ZRK 1205	71747596	4 PK 805
5992518	373UT	71719738	4 PK 665	71747799	371ST
5997325	351ST	71719745	5 PK 905	71749421	5 PK 962
5997326	351ST	71728659	6 PK 1090	71749424	4 PK 913
60565258	4 PK 790	71731639	ZRK 1113	71749430	5 PK 1055
60568842	7 PK 1240	71732350	5 PK 1145	71749436	6 PK 698
60573075	7 PK 1175	71732394	6 PK 1795	71749441	6 PK 925
60575209	4 PK 763	71734715	6 PK 1760	71749447	5 PK 1175
60596372	365ST	71734716	6 PK 1740	71749452	6 PK 1751
60607965	378UT	71734717	6 PK 1820	71749457	6 PK 935
60610910	6 PK 1840	71734799	368ST	71749460	4 PK 950
60610911	6 PK 1045	71736242	6 PK 1270	71749475	ZRK 1310
60617860	6 PK 1045	71736257	6 PK 1360	71753156	ZRK 1469
60617861	6 PK 1045	71736493	370UT	71753670	6 PK 1840
60617862	6 PK 1840	71736715	KT 1081	71753676	4 PK 962
60617863	6 PK 1840	71736716	KT 1527	71754560	KT 1426
60620887	ZRK 1420	71736717	KT 1253	71771578	KT 1519 W1
60625129	ZRK 1306	71736718	KT 1316	71771579	KT 1535 W1
60625130	ZRK 1249	71736719	KT 1324	71771584	KT 1426 W1
60652129	378UT	71736720	KT 1229	71771588	KT 1415 W1
60656341	ZRK 1306	71736722	KT 1349	7301221	AVX 10 x 913
60656342	ZRK 1249	71736724	KT 1294	7301775	AVX 10 x 900
60664403	378UT	71736725	KT 1348	7302203	AVX 10 x 900
60666949	6 PK 1045	71736726	KT 1404	7302675	ZRK 1094
60666950	6 PK 1840	71736793	370UT	7302791	AVX 10 x 635





Teilenummer Part number	Abmessung Dimension
----------------------------	------------------------

Teilenummer Part number	Abmessung Dimension
----------------------------	------------------------

Teilenummer Part number	Abmessung Dimension
----------------------------	------------------------

**FIAT**

7303004	AVX 10 x 925
7303414	ZRK 1100
7303415	ZRK 1102
73501580	6 PK 1760
73501649	6 PK 1195
73501904	5 EPK 926
73502928	6 PK 1360
73502929	6 PK 1360
73503128	170UT
73636895	3 PK 913
7533266	ZRK 1213
7533267	ZRK 1213
7533397	AVX 10 x 775
7535218	AVX 10 x 675
7540301	382UT
7541662	AVX 10 x 913
7541718	174UT
7548076	ZRK 1286
7552281	AVX 10 x 1090
7552380	AVX 10 x 775
7553224	5 PK 850
7553564	361ST
7553565	362UT
7553760	353ST
7553761	354UT
7554701	ZRK 1111
7565583	ZRK 1053
7565617	ZRK 1248
7565945	6 PK 1610
7575315	AVX 10 x 1000
7576114	AVX 10 x 1090
7576135	ZRK 1244
7581316	AVX 10 x 825
7581464	AVX 10 x 675
7589248	AVX 13 x 825
7596397	AVX 10 x 1025
7596692	ZRK 1251
7596722	ZRK 1253
7596727	373UT
7596728	363UT
7596876	373UT
7596877	363UT
7596960	ZRK 1250
7604445	5 PK 985
7609091	AVX 10 x 913
7609093	AVX 10 x 888
7610476	AVX 10 x 710
7610945	AVX 10 x 675
7611334	AVX 10 x 650
7613823	ZRK 1254
761473	AVX 13 x 1325
761473	AVX 13 x 1325 TM
761474	AVX 13 x 1325
761474	AVX 13 x 1325 TM
7614957	AVX 10 x 735
761499	AVX 13 x 1375
761499	AVX 13 x 1375 TM
7614999	ZRK 1286
7615058	5 PK 985
7617214	AVX 13 x 1050
7617420	AVX 10 x 935
7617420	AVX 10 x 938
7617421	4 PK 890
761769	AVX 13 x 1375
761769	AVX 13 x 1375 TM

**FIAT**

7618111	5 PK 925
7619418	AVX 10 x 675
7621046	5 PK 1060
7621256	AVX 13 x 875
7623829	AVX 10 x 685
7627106	5 PK 920
7627201	5 PK 1015
7629031	5 PK 905
7629229	5 PK 920
7629235	AVX 13 x 765
7629316	AVX 13 x 800
7629479	5 PK 905
7631375	5 PK 925
7631670	AVX 10 x 850
7631671	AVX 10 x 850
7632090	5 PK 962
7633335	AVX 10 x 735
7633936	4 PK 1100
7635566	4 PK 1100
7636057	4 PK 1050
7636058	4 PK 1050
7636059	4 PK 1060
7636060	4 PK 1060
7636448	3 PK 675
7636895	3 PK 913
7636896	3 PK 913
7638224	AVX 10 x 735
7638225	AVX 10 x 735
7640256	5 PK 905
7640257	5 PK 985
7640258	5 PK 925
7640261	AVX 10 x 913
7644467	5 PK 962
7644875	4 PK 962
7644876	4 PK 962
7644928	AVX 10 x 800
7646725	ZRK 1027
7646849	5 PK 1055
7649219	AVX 13 x 850
7650608	AVX 10 x 850
7651197	4 PK 913
7651198	4 PK 913
7651549	AVX 13 x 750
7651558	5 PK 970
7652245	4 PK 1100
7655543	AVX 13 x 850
7655544	AVX 13 x 750
7657701	4 PK 925
7657703	4 PK 925
7658133	5 PK 1005
7659062	ZRK 1252
7659699	AVX 10 x 675
7665583	ZRK 1053
7671402	AVX 10 x 913
76770211	4 PK 675
7685363	AVX 10 x 1060
7692829	AVX 10 x 864
7695546	ZRK 1247
7695968	5 PK 1040
7701471773	KT 1217
7702169	5 PK 1055
7702175	4 PK 905
7702740	5 PK 1040
7704978	4 PK 675
7706132	5 PK 970

**FIAT**

7710579	ZRK 1249
7718418	5 PK 1104
7720923	AVX 13 x 1050
7721293	5 PK 935
7730052	6 PK 894
7730054	6 PK 925
7732138	5 PK 886
7732676	ZRK 1246
7742320	ZRK 1027
7743081	ZRK 1244
7743660	4 PK 870
7745354	4 PK 705
7749145	5 PK 940
7750728	3 PK 685
7753473	3 PK 720
7753474	4 PK 950
7758970	5 PK 925
7758972	4 PK 962
7761146	4 PK 940
7761147	5 PK 940
7762910	ZRK 1243
7763644	370UT
7763980	4 PK 905
7764894	4 PK 925
7764914	ZRK 1747
7765715	5 PK 925
7765716	4 PK 913
7765717	5 PK 962
7765718	4 PK 962
7765719	5 PK 886
7765720	AVX 10 x 685
7766106	6 PK 1138
7766684	6 PK 1038
7771529	4 PK 1005
7771530	AVX 10 x 685
7772961	229ST
7774591	ZRK 1252
7778459	3 PK 935
7778565	371ST
7780420	6 PK 935
7780556	6 PK 985
7780557	6 PK 985
7781034	4 PK 750
7782192	367ST
7789700	5 PK 1435
7798114	6 DPK 1237
7798722	6 PK 698
7799581	4 PK 855
7813076000	AVX 10 x 888
82068043	AVX 10 x 775
82332275	AVX 10 x 700
82341655	AVX 13 x 1825
82342730	AVX 10 x 1140
82398036	AVX 10 x 775
82401268	AVX 13 x 1400
82401269	AVX 13 x 1225
82404105	AVX 10 x 825
8814832	AVX 13 x 1275
8814832	AVX 13 x 1275 TM
8827589	AVX 13 x 1285
9150694980	AVX 10 x 925
9153623080	5 PK 970
9153670080	AVX 10 x 925
9400816190	ZRK 1149
9400816549	ZRK 1144



Teilenummer Part number	Abmessung Dimension
----------------------------	------------------------

Teilenummer Part number	Abmessung Dimension
----------------------------	------------------------

Teilenummer Part number	Abmessung Dimension
----------------------------	------------------------

**FIAT**

9400816589	ZRK 1262
9400816939	ZRK 1351
9400816969	ZRK 1352
9400816989	ZRK 1029
9400818199	275ST
9400829598	437ST
9400829629	250UT
9400829669	294ST
9400829929	294ST
9400830149	255UT
9400830289	293UT
9400830319	293UT
9400830379	255UT
9400830429	295UT
9400830509	448UT
9400831069	KT 1068
9400831279	KT 1040
9400831349	KT 1522
9400831409	KT 1327
9400831489	KT 1216
9400831529	KT 1070
9400831559	KT 1244
9400831589	KT 1433
9400831609	KT 1350
9400831629	KT 1327
9400831739	KT 1351
9400831789	KT 1327
9400831829	KT 1327
9400831869	KT 1370
9400831889	KT 1244
94633780	6 PK 1390
9463380180	ZRK 1445
9463380680	ZRK 1352
9464034300	ZRK 1441
9464034380	ZRK 1441
9464464980	ZRK 1149
9464640480	447ST
9464867280	6 PK 1675
9467521380	431ST
9467544580	KT 1415
9467565880	ZRK 1460
9467581780	ZRK 1457
9467637180	ZRK 1592
9467642480	ZRK 1592
9607451480	251SR
9608859180	278SR
96142840	6 PK 698
9614284080	6 PK 698
96152078	6 PK 1660
9615207880	6 PK 1660
96152079	6 PK 1660
96152082	6 PK 1070
9615208280	6 PK 1070
96152084	6 PK 1078
9615208480	6 PK 1078
96152085	6 PK 1078
96152089	6 PK 1100
9615208980	6 PK 1100
9615923380	277UT
96170126	6 PK 1165
9617012680	6 PK 1145
9617188680	274ST
96188879	6 PK 1115
9618887980	6 PK 1115
96188881	6 PK 1740

**FIAT**

9619779380	ZRK 1128
96205509	6 PK 1605
9620550980	6 PK 1605
96209038	6 PK 730
9620903880	6 PK 730
96225212	6 PK 1115
9622521280	6 PK 1115
96225213	6 PK 1740
9622574480	283ST
9623436980	6 PK 1153
96236847	6 PK 1165
9623684780	6 PK 1145
96242335	4 PK 755
9624233580	4 PK 755
96242336	4 PK 755
9624233680	4 PK 755
96242337	6 PK 1740
96242338	6 PK 1105
9624233880	6 PK 1105
96267903	6 PK 1390
9627860780	251SR
96284665	6 PK 1740
9628990280	554UT
96290540	6 PK 1740
9629054080	6 PK 1740
96294857	6 PK 865
96294872	6 PK 1025
96307961	6 PK 1751
9630796180	6 PK 1751
96313338	6 PK 1740
96324103	6 PK 1740
96324104	6 PK 1740
9632722180	295UT
9633010080	6 PK 865
96330104	6 PK 1045
9633010480	6 PK 1045
96334781	6 PK 1470
9633478180	6 PK 1470
9634765180	6 PK 1710
9637513980	ZRK 1445
9637514080	ZRK 1445
9637529480	6 PK 1440
9638027080	6 PK 1580
9638234780	6 PK 1470
9638464180	6 PK 1735
9638464380	6 PK 1751
9641069580	6 PK 1190
9641198680	6 PK 1440
9641539380	332UT
9641705880	6 PK 1710
9642430680	6 PK 1185
9642929880	345ST
9643329680	294ST
9644846680	6 PK 1740
9647463180	6 PK 1470
9651255780	6 PK 1565
9652250480	6 PK 870
9652250580	6 PK 870
9652746480	6 PK 1185
9654114480	6 PK 1710
9655945780	6 PK 1215
9658144280	4 EPK 922
9658144580	6 EPK 873
9658643680	6 PK 1205
9662187580	ZRK 1575

**FIAT**

9662806680	6 PK 1670
9664069380	6 EPK 873
9664069480	4 EPK 922
9664471589	6 PK 1390
98415921	ZRK 1316
98419390	ZRK 1312
98455448	5 PK 886
98485800	5 PK 1080
98487322	6 PK 894
987107	AVX 10 x 775
99456476	ZRK 1312
99456477	ZRK 1332
99461357	359UT
99461358	357ST
99461393	6 PK 913
99462544	5 PK 1104
KTBWP4920	KT 1415 W1

**FORD**

028260849D	6 PK 1145
028903137AM	6 PK 925
028903137T	6 PK 1045
1000156	ZRK 1184
1000158	ZRK 1184
1000159	327ST
1004297	ZRK 1172
1004299	ZRK 1172
1004409	325ST
1004484	6 PK 1185
1004485	6 PK 1751
1004486	6 PK 1930
1004487	6 PK 1775
1004582	6 PK 858
1004583	6 PK 1735
1005120	111UT
1005516	324ST
1005822	320ST
1005823	304UT
1005824	ZRK 1000
1005828	ZRK 1000
1009900	6 PK 1440
10111698	6 PK 1900
1011614	6 PK 1950
1011616	6 PK 1413
1011688	6 PK 1820
1011696	6 PK 1352
1011697	6 PK 913
1011698	6 PK 1900
1013197	6 PK 2100
1013202	6 PK 2080
1014374	6 PK 1718
1015694	6 PK 1420
1017591	5 PK 886
1017592	5 PK 1140
1017593	5 PK 675
1019889	6 PK 1440
1021706	316ST
1021707	317ST
1027405	6 PK 2040
1028278	5 PK 1015
1028279	5 PK 1025
1028280	5 PK 710
1033499	6 PK 2040
1033500	6 PK 1755 TM
1036916	6 PK 1940



Teilenummer Part number	Abmessung Dimension	Teilenummer Part number	Abmessung Dimension	Teilenummer Part number	Abmessung Dimension
<b>FORD</b>		<b>FORD</b>		<b>FORD</b>	
1036917	6 PK 1760	1111928	6 DPK 1195	1229549	6 PK 975
1037149	ZRK 1290	1112530	KT 1011	1229723	ZRK 1460
1037660	ZRK 1184	1112531	ZRK 1434	1229768	KT 1390
1039422	231ST	1112954	6 PK 1940	1231960	6 PK 1215
1039799	5 PK 1140	1113169	ZRK 1000	1231975	447ST
1039800	6 PK 925	1113174	249ST	1231976	ZRK 1452
1040677	317ST	1113179	ZRK 1000	1231978	448UT
1040678	316ST	1113180	ZRK 1353	1231979	KT 1428
1040754	6 PK 1432	1113355	231ST	1232500	6 PK 1305
1040760	6 PK 1570	1119021	152ST	1250636	ZRK 1338
1041193	6 PK 1751	1119023	161ST	1253937	6 PK 1215
1041194	6 PK 1930	1119151	6 PK 1265	1301972	231ST
1041869	ZRK 1225	1120198	6 PK 2228	1301973	231ST
1049578	6 PK 1975	1120199	4 PK 735	1303612	3 PK 675
1049613	6 PK 2100	1124040	KT 1319	1303613	5 PK 1015
1049653	ZRK 1425	1125415	6 PK 1642	1303771	ZRK 1184
1050417	6 PK 2120	1127235	6 PK 1685	1303929	6 PK 2191
1051901	114SR	1127408	6 PK 1775	1308095	6 PK 2225
1053837	ZRK 1184	1129181	7 PK 2710 TM	1308228	6 PK 1460
1056697	317ST	1129182	7 PK 2875 TM	1316336	6 PK 1520
1056892	ZRK 1424	1129745	6 PK 1950	1316337	6 PK 1352
1057840	4 PK 1485	1131812	ZRK 1338	1320286	6 PK 1675
1058458	128ST	1133958	6 PK 1420	1320289	6 PK 1920
1059982	4 PK 1510	1133960	6 PK 1718	1328472	327ST
105E8620A	AVX 10 x 750	1135354	ZRK 1425	1343139	6 PK 2215
1068252	6 PK 1900	1135355	ZRK 1424	1343681	6 PK 2270
1070102	6 PK 1765	1135356	328UT	1346034	5 EPK 705
1072031	327ST	1135358	KT 1240	1348648	KT 1328
1072131	231ST	1135719	6 PK 1145	1353946	4 EPK 711
1072316	6 PK 1740	1136426	KT 1241	1359934	331ST
1072317	6 PK 1890	1137008	6 PK 1915	1361185	6 PK 1352
1079173	329ST	1141314	6 PK 1345	1361840	231ST
1079383	6 PK 1413	1141315	6 PK 1710	1370971	5 PK 850
1079384	6 PK 1718	1141317	5 EPK 690	1370974	5 PK 890
1079390	ZRK 1353	11425146	AVX 10 x 950	1371753	707UT
1084993	6 PK 1675	1142688	6 EPK 1042	1372764	7 PK 2842 TM
1084994	6 PK 1920	1143407	6 EPK 1019	1373250	ZRK 1460
1085038	6 PK 1445	11436104	AVX 10 x 1100	1373306	KT 1390
1087286	5 PK 886	11436795	AVX 10 x 1125	1376104	6 PK 2205
1089877	6 PK 1700	11436796	AVX 10 x 1250	1376751	7 PK 2682 TM
1093816	5 PK 1140	11436933	AVX 10 x 1215	1376752	7 PK 2842 TM
1094675	6 PK 1930	11436934	AVX 10 x 1100	1380026	KT 1440
1094675	6 PK 1940	11446026	AVX 10 x 950	1380026	KT 1529
1095025	555UT	11446055	AVX 10 x 1000	1381643	6 PK 1205
1095321	5 PK 1025	11448389	AVX 10 x 1225	1381645	6 PK 1685
1097331	6 PK 1145	1145904	ZRK 1304	1383663	6 PK 1670
1097332	6 PK 1055	1145947	331ST	1387692	6 PK 2225
1099552	317ST	1145950	ZRK 1441	1387693	6 PK 2215
1099553	316ST	1145955	332UT	1402165	AVX 13 x 1030
1099892	7 PK 2710 TM	11464038	AVX 10 x 1075	1416245	6 PK 2200
1099893	7 PK 2875 TM	11464038	AVX 10 x 1075 TM	1418182	6 PK 1685
1100566	151ST	11526149	AVX 10 x 850	1422141	6 PK 2215
1100583	159ST	118E8620A	AVX 10 x 750	1427353	6 PK 1748
1100585	160UT	1201255	KT 1319	1430423	AVX 10 x 785
1102826	6 PK 1610	1202679	6 PK 1685	1434283	6 PK 1670
1102827	6 PK 1642	1202680	6 PK 2176	1438094	ZRK 1213
1104087	231ST	1206466	6 PK 1642	1438244	6 PK 1215
1107573	327ST	1211185	KT 1328	1440434	7 PK 2842 TM
1108752	KT 1006	1213852	555UT	1446647	ZRK 1460
1108756	KT 1035	1215977	ZRK 1353	1446648	KT 1390
1108758	KT 1035	1215978	249ST	1451510	ZRK 1575
1110999	KT 1036	1217320	ZRK 1184	1461858	AVX 13 x 1125
1111241	6 DPK 1320	1221490	162ST	1461858	AVX 13 x 1125 TM
1111242	6 DPK 1320	1221491	163UT	1462109	AVX 13 x 1025
1111911	231ST	1229548	6 PK 800	1462109	AVX 13 x 1025 TM





Teilenummer Part number	Abmessung Dimension	Teilenummer Part number	Abmessung Dimension	Teilenummer Part number	Abmessung Dimension
<b>FORD</b>		<b>FORD</b>		<b>FORD</b>	
1465590	6 EPK 1029	1643815	AVX 10 x 913	2733E8620A	AVX 10 x 750
1467814	AVX 10 x 1250	1649170	ZRK 1039	2735E8620A	AVX 10 x 800
1471768	6 PK 2245	1649171	ZRK 1039	2735E8620C	AVX 10 x 800
1471770	6 PK 1840	1650769	6 PK 1230	2C1Q6C301A	6 PK 1642
1473402	6 PK 2215	1650770	6 PK 1820	2M216K254AA	162ST
1473889	AVX 10 x 864	1650771	6 PK 1965	2M216K297AA	163UT
1475778	AVX 13 x 1225	1653887	ZRK 1107	2M5V6C301A	6 PK 2115
1475778	AVX 13 x 1225 TM	1653888	ZRK 1104	2S616C301CA	6 PK 1345
1479084	249ST	1654387	6 PK 913	2S616C301DA	6 PK 1710
1481774	331ST	1657013	ZRK 1000	2S6E6C301CA	5 EPK 690
1494726	AVX 13 x 1175	1657176	311SR	2S6E6C301CB	5 EPK 690
1494787	6 PK 1748	1660555	ZRK 1104	2S6E6C301DA	6 EPK 1019
1496915	305ST	1663392	ZRK 1434	2S6E6C301DB	6 EPK 1019
1500004	326UT	1669898	ZRK 1290	2S6G6C301AA	6 PK 2240
1502521	AVX 10 x 888	1669904	128ST	2S6G6C301BA	6 PK 2191
1502917	AVX 10 x 930	1672143	KT 1297	2S6G6C301C	6 PK 2191
1502917	AVX 10 x 938	1672144	KT 1446	2S6G6C301JA	6 PK 1685
1502948	AVX 10 x 1250	1675963	ZRK 1172	2S6G6C301KA	6 PK 2176
1502949	AVX 10 x 1175	1683824	ZRK 1592	2S6Q6B217AA	331ST
1503819	AVX 10 x 925	1707030	ZRK 1592	2S6Q6B217AB	331ST
1503819	AVX 10 x 930	1776433	AVX 13 x 1150	2S6Q6B217AD	331ST
1511349	AVX 13 x 900	1776433	AVX 13 x 1150 TM	2S6Q6B217AE	331ST
1511349	AVX 13 x 918	1796765	AVX 10 x 1235	2S6Q6M250A	332UT
1515007	AVX 13 x 915	1805736	AVX 10 x 1400	2S6Q8A615AA	KT 1328
1517293	AVX 10 x 1300	1822583	AVX 13 x 1400	2S6Q8A615AB	KT 1328
1535422	5 PK 1145	1827214	AVX 13 x 1450	2T1Q6C301AA	6 PK 1460
1535430	4 PK 665	1827336	AVX 13 x 1400	2T1Q6K254AA	249ST
1539584	6 PK 975	1836785	AVX 13 x 1400	2T1Q6K254AB	249ST
1539585	6 PK 800	1845565	AVX 13 x 1400	2T1Q6K288AA	ZRK 1353
1539603	6 PK 1185	1C1Q6C301A	6 EPK 831	2T1Q6M260A	KT 1319
1539606	6 PK 1310	1C1Q6C301B	6 PK 1775	3019406	6 PK 1110 TM
1540766	AVX 13 x 1150	1C1Q6C301C	6 PK 1950	3023786	6 PK 2155
1540766	AVX 13 x 1150 TM	1C1Q6C301D	6 PK 1642	3023801	6 PK 2075
1542571	AVX 13 x 1225	1C1Q6K254AA	328UT	3252663	ZRK 1225
1542571	AVX 13 x 1225 TM	1C1Q6K288AA	ZRK 1425	3256730	ZRK 1225
1556515	AVX 13 x 1550	1C1Q6K288BA	ZRK 1424	3395996	186UT
1558205	6 PK 1110 TM	1C1Q6M260A	KT 1241	3396014	187UT
1558384	ZRK 1213	1F1E8620AB	6 PK 2160	3396016	197UT
1558385	ZRK 1212	1M216268AA	ZRK 1304	3396755	ZRK 1210
1562503	331ST	1S4E-6C301-A	6 EPK 1042	3396756	ZRK 1234
1563257	5 PK 850	1S4E-6C301-A	6 EPK 1042	3396930	5 PK 1030
1563258	5 PK 890	1S4Q6C301AA	6 PK 1420	3396931	4 PK 920
1576573	AVX 10 x 1200	1S4Q6C301BA	6 PK 1718	3396932	5 PK 1165
1576983	AVX 10 x 763	1S7Q6C301AA	6 PK 2228	3396934	5 PK 860
1595814	AVX 11,9 x 982	1S7Q6C301AB	6 PK 2225	3396935	5 PK 1015
1599251	AVX 13 x 1450	1S7Q6C301C	6 PK 1642	3406363	4 PK 920
1608672	AVX 13 x 1225	2027E8A602B	AVX 10 x 1325	3501607	6 PK 2415
1608672	AVX 13 x 1225 TM	2400E8620A	AVX 10 x 1025	3593430	ZRK 1393
1608673	AVX 13 x 1225	2400E8A602A	AVX 10 x 1350	3599764	AVX 13 x 1100
1608673	AVX 13 x 1225 TM	2701E8620	AVX 13 x 1175	3610825	AVX 13 x 1475
1612264	AVX 10 x 950	2701E8620B	AVX 13 x 1175	3610825	AVX 13 x 1475 TM
1612265	AVX 10 x 725	2701E8620B	AVX 13 x 1175 TM	3661243	186UT
1612266	AVX 10 x 1060	2703E8620A	AVX 13 x 1375	3730289	5 PK 1015
1612286	AVX 13 x 925	2703E8620A	AVX 13 x 1375 TM	3864995	196UT
1612286	AVX 13 x 925 TM	2706E8620	AVX 13 x 1150	3872248	AVX 13 x 1100
1629019	AVX 10 x 838	2706E8620	AVX 13 x 1150 TM	3894197	198UT
1629874	AVX 10 x 913	2710E2890A	AVX 13 x 1025	3895178	953ST
1629875	AVX 10 x 1175	2710E3K532A	AVX 13 x 900	3895193	954UT
1631030	AVX 13 x 1050	2710E3K532A	AVX 13 x 900 TM	3900579	ZRK 1168
1631113	AVX 10 x 710	2710E8620	AVX 13 x 1175	3902552	5 PK 1165
1634741	AVX 10 x 900	2710E8620	AVX 13 x 1175 TM	39108240	AVX 13 x 1175
1634792	AVX 10 x 775	2720E8A602B	AVX 10 x 1325	39108240	AVX 13 x 1175 TM
1634792	AVX 11,9 x 772	2720E8A602C	AVX 10 x 1375	3910825	AVX 13 x 1475 TM
1638510	AVX 10 x 975	2724E8A602B	AVX 10 x 1225	3935008	6 PK 2075
1639171	ZRK 1143	2725E8A602A	AVX 10 x 1300	3954187	3 PK 685



Teilenummer Part number	Abmessung Dimension
----------------------------	------------------------

Teilenummer Part number	Abmessung Dimension
----------------------------	------------------------

Teilenummer Part number	Abmessung Dimension
----------------------------	------------------------

## FORD

## FORD

## FORD

3968234	6 PK 2176
3973814	5 PK 1015
3973914	5 PK 1015
3994039	198UT
3M216268AA	ZRK 1338
3M5Q6B217A	447ST
3M5Q6C301A	6 PK 1305
3M5Q6C301A	6 PK 1305
3M5Q6C301C	5 EPK 705
3M5Q6D314C	5 EPK 705
3M5Q6K288A	ZRK 1460
3M5Q6K288A	ZRK 1460
3M5Q6K288B	ZRK 1452
3M5Q6K288C	ZRK 1460
3M5Q6M250A	448UT
3M5Q8A615A	KT 1390
3M5Q8A615A	KT 1390
3M5Q8A615B	KT 1428
3M5Q8A615C	KT 1390
3M5Q8A615D	KT 1297
3S4G6268A3A	ZRK 1184
3S5Q6C301BA	6 PK 2191
3U7J6C301BA	6 PK 1920
4001215	6 PK 1820
4004766	6 PK 2155
4024820	6 PK 1820
4038260	4 PK 920
4070307	ZRK 1168
4071946	6 PK 2191
4132488	186UT
4160169	6 PK 2080
4187984	6 PK 2160
4188176	6 PK 2160
4188206	6 PK 1820
4335876	6 PK 2075
4404004	6 PK 2115
4600280	6 PK 2075
4L5E8620EA	6 PK 2205
4L5Z8620EA	6 PK 2205
4M5G6K254C	231ST
4M5G6K254D	231ST
4M5G6K254D	231ST
4M5Q6C301B	5 EPK 868
4M5Q6C301C	6 PK 800
4M5Q6C301D	6 PK 975
4M5Q6C301E	6 PK 1215
4M5Q6C301E	6 PK 1215
4M5Q6C301F	6 PK 1215
4M5Q6C301G	6 PK 1520
4M5Q6C301H	6 EPK 1059
4M5Q6C301JA	6 EPK 1059
4S4Q6C301C	6 PK 2225
4S7Q6C301C	4 EPK 711
4U3Q6C301A	6 PK 1885
500E8620B	AVX 13 x 1100
5013519	AVX 10 x 813
5016346	AVX 13 x 850
5016347	AVX 10 x 625
5030074	4 PK 1510
5L8Q6C301AB	6 PK 2270
5M5Q6C301C	6 PK 1352
5M5Q6C301D	6 EPK 1090
5M5Q8A615A	KT 1446
5S6G6006AA	6 PK 2215
5S6G6006AC	6 PK 2215

5S6Q6C301BA	6 PK 2215
6008693	AVX 13 x 1125
6008693	AVX 13 x 1125 TM
6008696	AVX 10 x 1200
6012012	AVX 13 x 900
6012012	AVX 13 x 900 TM
6025814	AVX 13 x 1225
6031973	AVX 13 x 1550
6044423	AVX 10 x 800
6044423	AVX 10 x 813
6044992	AVX 10 x 864
6044992	AVX 11,9 x 864
6044993	AVX 10 x 1000
6044994	AVX 10 x 1150
6044995	AVX 10 x 800
6044996	AVX 10 x 1300
6044997	AVX 10 x 1325
6049674	AVX 10 x 813
6052763	AVX 13 x 1250
6052763	AVX 13 x 1275
6057341	AVX 11,9 x 1010
6057341	AVX 13 x 1275
6057343	AVX 10 x 1013
6057343	AVX 11,9 x 1010
6058147	AVX 11,9 x 1042
6058199	AVX 10 x 1013
6058200	AVX 10 x 864
6058200	AVX 11,9 x 864
6058201	AVX 10 x 1150
6065559	AVX 10 x 1250
6069433	AVX 13 x 1025
6069433	AVX 13 x 1025 TM
6070707	AVX 10 x 975
6076173	AVX 13 x 1125
6076173	AVX 13 x 1125 TM
6077865	AVX 10 x 813
6085347	AVX 13 x 1175
6085347	AVX 13 x 1175 TM
6086008	AVX 10 x 1013
6088696	AVX 13 x 1500
6089286	300ST
6090670	AVX 10 x 763
6090671	AVX 10 x 800
6092137	ZRK 1104
6092138	ZRK 1107
6094168	313SR
6094632	AVX 10 x 1275
6096292	AVX 13 x 1150
6096292	AVX 13 x 1160
6098570	AVX 11,9 x 864
6098572	AVX 10 x 1000
6104232	AVX 10 x 825
6104676	AVX 10 x 775
6104676	AVX 10 x 785
6107313	AVX 13 x 1050
6107313	AVX 13 x 1050 TM
6107712	AVX 11,9 x 876
6107729	AVX 10 x 1175
6107729	AVX 11,9 x 1171
6109189	ZRK 1104
6109190	ZRK 1107
6110531	AVX 10 x 913
6111516	ZRK 1093
6112414	AVX 10 x 1000
6116759	AVX 13 x 1525

6121753	306ST
6121754	306ST
6121780	302ST
6122575	AVX 10 x 1075
6122575	AVX 10 x 1075 TM
6126515	AVX 10 x 675
6130086	5 PK 820
6131141	301ST
6132587	AVX 11,9 x 885
6134738	AVX 11,9 x 793
6134739	AVX 11,9 x 783
6137573	AVX 10 x 850
6138211	AVX 11,9 x 1036
6138677	ZRK 1098
6139910	ZRK 1212
6139911	ZRK 1213
6144781	AVX 13 x 900
6144787	AVX 13 x 1175
6145027	300ST
6146160	AVX 10 x 888
6146161	AVX 10 x 875
6146319	4 PK 1520
6146320	4 PK 1520
6147689	AVX 10 x 950
6153229	AVX 10 x 913
6154540	AVX 10 x 1175
6155206	AVX 10 x 913
6155998	AVX 11,9 x 1010
6156360	AVX 10 x 925
6158123	AVX 13 x 900
6158124	AVX 13 x 875
6158131	AVX 13 x 1175
6158132	AVX 13 x 1175
6158518	AVX 11,9 x 758
6158691	AVX 10 x 675
6158758	AVX 10 x 940
6158759	AVX 10 x 710
6161559	AVX 10 x 975
6161560	AVX 10 x 975
6162731	ZRK 1104
6162732	ZRK 1107
6166102	AVX 13 x 1150
6166103	AVX 13 x 1025
6166104	AVX 10 x 685
6167901	AVX 11,9 x 690
6168158	6 PK 1820
6169928	AVX 13 x 1200
6169929	AVX 13 x 1200
6170166	3 PK 830
6174797	AVX 10 x 800
6175292	AVX 10 x 913
6177882	320ST
6177883	310UT
6177884	304UT
6177887	ZRK 1000
6178656	323ST
6180848	5 PK 1015
6180849	5 PK 1015
6180852	6 PK 1635
6180853	6 PK 1635
6180854	6 PK 1420
6180855	6 PK 1420
6182205	4 PK 1520
6182328	3 PK 648
6182475	AVX 13 x 1025



Teilenummer Part number	Abmessung Dimension
----------------------------	------------------------

Teilenummer Part number	Abmessung Dimension
----------------------------	------------------------

Teilenummer Part number	Abmessung Dimension
----------------------------	------------------------

**FORD**

6182476	AVX 13 x 1150
6182611	5 PK 790
6182615	6 PK 1820
6182891	301ST
6185100	3 PK 1025
6185651	3 PK 648
6185652	3 PK 815
6189780	AVX 13 x 950
6190857	315SR
6195101	ZRK 1424
6196578	AVX 10 x 813
6196579	AVX 10 x 800
6198309	6 PK 1270
6200264	6 PK 1900
6200265	6 PK 1900
6200268	6 PK 1540
6200269	6 PK 1540
622E8620A	AVX 13 x 1150
622E8620A	AVX 13 x 1150 TM
622E8620B	AVX 13 x 1175
622E8620B	AVX 13 x 1175 TM
6460878	6 PK 1413
6460879	AVX 10 x 990
6475968	ZRK 1000
6482249	319UR
6483250	6 PK 995
6483251	6 PK 995
6492482	304UT
6497120	323ST
6511601	6 PK 1560
6511602	6 PK 1560
6518069	4 PK 1485
6518322	4 PK 1520
6534254	4 PK 962
6534255	4 PK 962
6550963	6 PK 1352
6550964	6 PK 1352
6592377	5 PK 1055
6593893	3 PK 675
6606513	6 PK 1413
6606514	6 PK 1413
6613362	6 PK 1413
6613363	6 PK 1413
6616951	315SR
6616952	312SR
6635941	307ST
6635941	322ST
6635942	308UT
6680459	3 PK 648
6680460	3 PK 815
6711044	ZRK 1108
6711046	ZRK 1107
6727879	6 PK 1718
6738365	6 PK 913
6738366	6 PK 913
6744307	309UT
674E8620	AVX 13 x 1225
674E8620	AVX 13 x 1225 TM
6758562	6 PK 1635
6758564	6 PK 995
6764161	ZRK 1434
6764162	ZRK 1434
6776020	5 PK 886
6788619	6 PK 1800
6788621	6 PK 1950

**FORD**

6788622	6 PK 1950
6792801	AVX 10 x 800
6793377	4 PK 980
6793378	4 PK 980
6805275	4 PK 985
6811351	6 PK 2080
6830821	ZRK 1108
6830822	ZRK 1107
6833788	6 PK 1820
6833789	6 PK 1900
683F8620BA	AVX 13 x 1150
683F8620BA	AVX 13 x 1150 TM
683F8620GAA	AVX 13 x 1350
683F8620GAA	AVX 13 x 1350 TM
683F8620HAA	AVX 13 x 1125
683F8620HAA	AVX 13 x 1125 TM
6842244	5 PK 870
6844096	6 PK 1650
6904228	5 PK 1015
6911495	5 PK 580
691F8620AA	AVX 10 x 740
6958518	AVX 10 x 750
6958518	AVX 11,9 x 758
6960612	6 PK 1265
6961947	6 PK 1655
6988203	320ST
6992533	6 PK 935
6994216	5 PK 710
69DB2890BA	AVX 13 x 1025
69DB2890BA	AVX 13 x 1025 TM
69MF8A615BA	AVX 13 x 1225
69MF8A615BA	AVX 13 x 1225 TM
6C1Q6C301A	4 EPK 922
6C1Q6C301B	6 EPK 873
6C1Q6C301C	6 PK 1670
6C1Q6C301C	6 PK 1670
6C1Q6C301G	7 PK 2682 TM
6C1Q6C301H	7 PK 2842 TM
6C1Q6C301H	7 PK 2842 TM
6G9Q6C301B	6 PK 1205
6G9Q6C301C	6 PK 2200
6G9Q6C301D	6 PK 1685
6G9Q6C301E	6 PK 1685
6G9Q6K288A	ZRK 1575
6H5Q6C301B	6 PK 1748
6M5G6M250A	707UT
6M5Q6C301A	5 PK 850
6M5Q6C301A	5 PK 850
6M5Q6C301B	5 PK 890
6M5Q6C301B	5 PK 890
6M5Q6C301E	6 PK 975
6M5Q6C301F	6 PK 800
6T1Q6C301AA	6 PK 1748
7003984	6 PK 913
7007791	4 PK 860
7008651	6 PK 1920
7008652	6 PK 1555
7019148	6 PK 1540
7026196	AVX 10 x 850
703F8620ABA	AVX 13 x 1200
703F8620ABA	AVX 13 x 1200 TM
703F8620ACA	AVX 13 x 1350
703F8620ACA	AVX 13 x 1350 TM
703F8620ADA	AVX 13 x 1150
703F8620ADA	AVX 13 x 1150 TM

**FORD**

7040340	4 PK 825
7053546	319UR
7053802	304UT
7056787	AVX 10 x 888
7056788	AVX 10 x 875
7064725	6 PK 1413
7064726	6 PK 1775
7064727	6 PK 1930
7064728	6 PK 1975
7082866	4 PK 1015
70HM6268A1A	ZRK 1212
70HM6268A2A	ZRK 1212
70HM6268AA	ZRK 1212
70HM6268B1A	ZRK 1213
70HM6268BA	ZRK 1213
70HM6K254A	305ST
70TF8620AA	AVX 10 x 1075
70TF8620AA	AVX 10 x 1075 TM
70TF8620DA	AVX 13 x 1200
70TF8620EA	AVX 10 x 1000
70TM8620AA	AVX 10 x 1175
70TN8620PA	AVX 10 x 1050
711F8620AA	AVX 10 x 838
7120853	6 PK 1635
7120854	6 PK 1432
7136447	6 PK 1015
7136449	6 PK 1655
7143870	6 PK 1675
7158659	4 PK 654
715F2890AAA	AVX 10 x 930
715F2890ABA	AVX 10 x 930
715F2890ABA	AVX 10 x 938
715F8620ABA	AVX 10 x 888
715F8620ACA	AVX 10 x 1250
715F8620AEA	AVX 10 x 1175
715F8620AGA	AVX 10 x 888
715F8A615AB	AVX 10 x 888
715FGA265AA	326UT
7174104	ZRK 1000
7174114	ZRK 1000
7184208	AVX 10 x 1250
718620AB	AVX 10 x 864
718F8620AAA	AVX 10 x 1050
7198530	6 PK 1145
7198532	6 PK 1045
7198535	7 PK 1290
7198536	7 DPK 1360
71HF8620AB	AVX 10 x 864
71HF8620AB	AVX 11,9 x 864
71TF8620AA	AVX 10 x 1000
7204035	6 PK 1820
7204036	6 PK 1590
7204039	3 PK 685
722C8620DC	AVX 13 x 915
722F8620DC	AVX 13 x 900
722F8620EB	AVX 10 x 1325
722F8620FA	AVX 10 x 1300
7239510	6 PK 1570
723F8620AAA	AVX 13 x 1150
723F8620AAA	AVX 13 x 1150 TM
723F8620ABA	AVX 13 x 1125
723F8620ABA	AVX 13 x 1125 TM
723F8620AEA	AVX 10 x 1175
7252517	4 PK 1485
7252518	4 PK 1510



Teilenummer Part number	Abmessung Dimension
----------------------------	------------------------

Teilenummer Part number	Abmessung Dimension
----------------------------	------------------------

Teilenummer Part number	Abmessung Dimension
----------------------------	------------------------

## FORD

## FORD

## FORD

725F8620BAA	AVX 13 x 1225
725F8620BAA	AVX 13 x 1225 TM
7286575	6 PK 1920
7287675	6 PK 1920
72HF8620BA	AVX 10 x 875
72TF8620BA	AVX 13 x 1175
72TF8620DA	AVX 10 x 1150
7310608	6 PK 1755 TM
7310609	6 PK 1900
7330712	323ST
7400530	111UT
7410970	5 PK 1015
742F8620AA	AVX 13 x 900
742F8620AA	AVX 13 x 900 TM
742F8620BA	AVX 10 x 1350
749F8620AAA	AVX 13 x 1550
749F8620ABA	AVX 13 x 1550
749F8622ABA	AVX 13 x 1550
749F8K569AB	6 PK 1110 TM
74TF8620EA	AVX 13 x 1225
74TF8620FA	AVX 13 x 1275
761F8620AA	AVX 10 x 813
762F8620AA	AVX 10 x 1300
762F8620BA	AVX 10 x 1325
76HF8620BA	AVX 10 x 864
76HF8620CA	AVX 10 x 864
76HF8620CA	AVX 11,9 x 864
76TF8620BA	AVX 10 x 1000
76TF8620DA	AVX 10 x 1150
77BF6C031AC	AVX 10 x 800
77BF6C301AC	AVX 10 x 800
77DB2890AA	AVX 13 x 1025
77DB2890AA	AVX 13 x 1025 TM
785F8620AAA	AVX 10 x 1250
78EF8620CA	AVX 10 x 1200
78EF8620EA	AVX 10 x 763
78F8620AAA	AVX 10 x 1250
78HF8620AB	AVX 10 x 864
78HF8620BA	AVX 10 x 1175
78HF8620BB	AVX 11,9 x 1042
78HF8620CA	AVX 10 x 864
78HF8620CA	AVX 11,9 x 864
78HF8A615AA	AVX 11,9 x 1042
78TF6C301BA	AVX 13 x 1275
78TF6C301CA	AVX 13 x 1250
78TF8620CA	AVX 11,9 x 1010
78TF8620EA	AVX 10 x 1150
79EF8620C	AVX 10 x 763
79EF8620CA	AVX 10 x 750
79HF8620BB	AVX 11,9 x 1010
79TF6C301DA	AVX 10 x 975
79TF8A615AA	AVX 11,9 x 1010
7G9Q6C301B	6 PK 2245
7G9Q6C301C	6 PK 1840
7S7Q6C301A	6 EPK 1029
7S7Q6C301BB	5 EPK 694
7S7Q6D314AA	6 EPK 1029
801F6C301CA	AVX 10 x 818
80HF6C3010B	AVX 11,9 x 864
80TF6C301BA	AVX 13 x 1160
80TF6C301DA	AVX 10 x 1000
813F8620HBA	AVX 13 x 1125
813F8620HBA	AVX 13 x 1125 TM
813F8620JAA	AVX 13 x 1175
813F8620JAA	AVX 13 x 1175 TM

81AB6C301DB	AVX 11,9 x 772
81AB6C301EB	AVX 10 x 800
81MF3N533AA	AVX 13 x 925
81MF3N533AA	AVX 13 x 925 TM
81SM6268GE	ZRK 1104
81SM6268HE	ZRK 1107
81SM6268LA	ZRK 1104
81SM6268MA	ZRK 1107
81TF6C301BA	AVX 13 x 1160
821F6C301AA	AVX 10 x 825
821F6C301AC	AVX 10 x 825
821M6C301AA	AVX 10 x 825
826F8620EDA	AVX 13 x 1450
826F8620EEA	AVX 13 x 1500
82DB8N620AA	AVX 13 x 1050
82DB8N620AA	AVX 13 x 1050 TM
82EF6C301AA	AVX 10 x 785
82MF8A615AA	AVX 13 x 1225
82MF8A615AA	AVX 13 x 1225 TM
82PF10N003A	AVX 13 x 1525
83BB6C301AA	AVX 10 x 913
83BB6C301AB	AVX 10 x 913
83DB10C318A	5 PK 820
83EF6C301AA	AVX 10 x 940
83EF8620AA	AVX 10 x 940
83EF8620BA	AVX 10 x 725
83EF8620CA	AVX 10 x 1060
83EF8A615AA	AVX 10 x 940
83GB6C301AA	AVX 10 x 1000
83HF6C301AA	AVX 10 x 875
83HF6C301AA	AVX 11,9 x 876
83HF6C301BA	AVX 11,9 x 1171
83HF8A615AA	AVX 11,9 x 1171
83TF6C301CA	AVX 13 x 1225
83TF6C301DA	AVX 10 x 1000
83TF8A615CA	AVX 10 x 1000
844F6K254AA	306ST
844F6K288AB	ZRK 1098
844F6K383AA	313SR
844F8620AA	AVX 10 x 1275
84AB6C301AA	AVX 11,9 x 806
84AB6C301AB	AVX 11,9 x 783
84AB6C301BA	AVX 10 x 785
84AB6C301BA	AVX 11,9 x 783
84FF8620AC	AVX 10 x 850
84FF8620AE	AVX 10 x 850
84FF8620AF	AVX 10 x 850
84FM6268AA	ZRK 1093
84FM6K254AB	302ST
84HF6C301AA	AVX 11,9 x 885
84HF6C301AB	AVX 10 x 875
84HM6268AA	ZRK 1212
84HM6268BA	ZRK 1213
84SF6C301AB	AVX 10 x 675
84SF6C301AC	AVX 11,9 x 670
84SM6K254AA	300ST
84SM6K254C	301ST
85BB6C301AA	AVX 10 x 925
85EF8620AA	AVX 10 x 710
85EF8620AB	AVX 10 x 710
85EF8620BA	AVX 10 x 710
85EF8620CA	AVX 10 x 1060
85EF8A615AA	AVX 10 x 950
85HF6C301AA	AVX 10 x 888
85HF6C301BB	AVX 10 x 1175

85HF6C301F2	AVX 10 x 913
85HF6C301FA	AVX 10 x 913
85HF6C301J1	AVX 10 x 975
85HF6C301J2	AVX 10 x 975
85HF8509AA	AVX 10 x 1175
85HF8A615AA	AVX 11,9 x 885
85HF8A615BB	AVX 10 x 1175
85HF8A615BB	AVX 11,9 x 1183
85HF8A615CA	AVX 10 x 913
85SF6C301AA	AVX 11,9 x 675
85TF6C301DB	AVX 11,9 x 1036
85TF6C301F1	AVX 13 x 900
85TF6C301F2	AVX 13 x 900
85TF6C301FA	AVX 13 x 900
85TF6C301GA	AVX 13 x 1175
85TF8A615D1	AVX 13 x 1175
85TF8A615D2	AVX 13 x 1175
85TF8A615DA	AVX 13 x 1175
85TF8A615EA	AVX 11,9 x 1036
864F8620A1A	4 PK 1520
864F8620A2A	4 PK 1520
864F8620AA	4 PK 1520
86AB6C301AA	AVX 11,9 x 772
86AB6C301BA	AVX 11,9 x 758
86BB8A615AA	AVX 10 x 913
86EF6C301AA	AVX 13 x 1150
86EF6C301BA	AVX 13 x 1025
86EF6C301CA	AVX 10 x 685
86SF6C301AA	AVX 11,9 x 690
86SM6268EA	ZRK 1104
86SM6268FA	ZRK 1107
86TF6C301AA	AVX 10 x 1013
86TF6C301AA	AVX 11,9 x 1010
86TF6C301BA	AVX 10 x 975
86TF6C301CA	AVX 10 x 888
87SF6C301CA	5 PK 790
87TF8A615A1	AVX 13 x 1200
87TF8A615A2	AVX 13 x 1200
88EF6C301AC	AVX 13 x 950
88EF6C301BA	AVX 13 x 1025
88EF6C301CA	AVX 13 x 1150
88HF19A216A	311SR
88HF6C301	AVX 13 x 1015 TM
88WF6C301A	6 PK 1230
88WF6C301B	6 PK 1820
88WF6C301B	6 PK 1820
88WF6C301B	6 PK 1820
88WF6C301C	6 PK 1560
88WF6C301C	6 PK 1560
88WF6C301D	6 PK 1965
88WF6C301E	6 PK 1270
88WF6C301F2	6 PK 1820
88WF6C301G	6 PK 1800
88WF6C301G	6 PK 1800
88WF6C301H	6 PK 1950
88WF6C301H	6 PK 1950
89AB6C301AB	6 PK 913
89BF6C301A1	AVX 11,9 x 793
89BF6C301A1	AVX 10 x 800
89BF6C301A2	AVX 10 x 800
89FF10039AB	3 PK 648
89FF19A216A	315SR
89FF19A216B	312SR
89FF6268AB	ZRK 1000
89FF6288AB	ZRK 1000



Teilenummer Part number	Abmessung Dimension	Teilenummer Part number	Abmessung Dimension	Teilenummer Part number	Abmessung Dimension
<b>FORD</b>		<b>FORD</b>		<b>FORD</b>	
89FF6C301A2	3 PK 648	92SF6C301A2	5 PK 1055	96FF6C301AC	5 PK 886
89FF6C301A2	3 PK 648	92TF6C301B1	6 PK 1413	96FF6C301AE	5 PK 886
89FF6C301B1	3 PK 830	92TF6C301B2	6 PK 1413	96FF6C301AF	5 PK 886
89FF6C301B2	3 PK 830	92XF8620BA	4 PK 1510	96FF6C301BC	5 PK 1130
89FF6C301D1	3 PK 1025	93BB6C301AA	6 PK 1718	96FF6C301BE	5 PK 1140
89FF6C301D2	3 PK 1025	93BB6C301AB	6 PK 1718	96FF6C301CC	5 PK 675
89FF6C301E2	3 PK 815	93BB6C301BD	6 PK 2080	96FF6C301CD	5 PK 675
89FF6C301E2	3 PK 815	93BB6C301BE	6 PK 2080	96FF6C301DA	5 PK 1015
89FF6K254AC	323ST	93BB6C301CD	5 PK 870	96FF6C301EA	5 PK 1025
89FF6K254AD	323ST	93BB6C301DD	5 PK 580	96FF6C301FA	5 PK 1025
89FF6K254CB	310UT	93BB6C301EC	5 PK 886	96FF6C301GA	5 PK 710
89FF6K254DC	304UT	93FF6C301AA	5 PK 1015	96FF6K254AA	324ST
89FF6K254DD	304UT	93FF6C301DA	5 PK 1015	96FF6K254BA	320ST
89FF6K288AA	ZRK 1000	93FF6K254BA	320ST	96FF6K254DB	304UT
89FF6K288AB	ZRK 1000	93TF6C301A1	4 PK 980	96FF6K288AB	ZRK 1000
89FF6K288AC	ZRK 1000	93TF6C301A2	4 PK 980	96MF6C301A	6 PK 1185
89SM6268AC	ZRK 1107	944F6C301CA	6 PK 1635	96MF6C301BA	6 PK 1765
89SM6268BC	ZRK 1104	948F6C301AB	6 PK 1265	96MF6C301B	6 PK 1751
90FF6268BA	ZRK 1000	948F6C301BA	6 PK 1540	96MF6C301C	6 PK 1930
91FF6C301A1	5 PK 1015	948F6C301CA	6 PK 1920	96MF6C301D	6 PK 1775
91FF6C301A2	5 PK 1015	948F6C301CB	6 PK 1920	96MM6K288A	ZRK 1172
91SF19A216A	319UR	948F6C301DA	6 PK 1555	96MM6K288A	ZRK 1172
91SF19A216A	319UR	94AB6C301AA	6 PK 1675	96MM6M250A	325ST
91SF6C301A1	6 PK 1635	94AB6C301C1	6 PK 1015	96WF6C301A	6 PK 2040
91SF6C301A2	6 PK 1635	94AB6C301D1	6 PK 1655	96WF6C301A	6 PK 2040
91SF6C301A2	6 PK 1635	94FB6C301A2	6 PK 935	96WF6C301B	6 PK 1755 TM
91SF6C301B1	6 PK 1420	94FB6C301B2	6 PK 913	974F6C301BA	4 PK 1485
91SF6C301B2	6 PK 1420	94FF6C301AC	4 PK 654	974F6C301CA	4 PK 1510
91SF6C301B2	6 PK 1420	94WF6C301A	6 PK 1413	974F6C301CE	4 PK 1510
91SF6C301C1	6 PK 995	94WF6C301B	6 PK 1775	974F6K288AB	ZRK 1425
91SF6C301C2	6 PK 995	94WF6C301D	6 PK 1930	978M6268A1A	ZRK 1184
91SF6C301C2	6 PK 995	94WF6C301E	6 PK 1975	978M6268A1B	ZRK 1184
91SM6268AA	ZRK 1108	954F8620AB	4 PK 1485	97AB6C301AA	6 PK 1675
91SM6268AAA	ZRK 1108	954F8620BB	4 PK 1510	97AB6C301BA	6 PK 1920
91SM6268BA	ZRK 1107	95BB6C301AA	6 PK 2100	97FF6C301AD	5 PK 1140
91TF6C301A1	6 PK 1413	95TF6C301BA	4 PK 1015	97FF6K254CB	316ST
91TF6C301A2	6 PK 1413	95VW3F572C	AVX 11,5 x 730	97FF6K254CC	316ST
91TF6C301B1	4 PK 962	95VW3F572D	AVX 11,5 x 790	97FF6K254DA	317ST
91TF6C301B2	4 PK 962	95VW6268DA	ZRK 1290	97FF6K254DB	317ST
91TX6C301A1	6 PK 1413	95VW6268DB	ZRK 1290	97FF6K254DC	317ST
91XF6C301B1	6 PK 1352	95VW6C301A	6 PK 1145	97FF6K254DD	317ST
91XF6C301B2	6 PK 1352	95VW6C301A	6 PK 1145	97KB6C301BA	6 PK 1760
91X6C301B1	6 PK 1352	95VW6C301A	6 PK 1145	97KB6C301DA	6 PK 1940
924F6K288AA	ZRK 1424	95VW6C301C	6 PK 1045	97MF6C301BA	6 PK 1765
924F6K288AB	ZRK 1424	95VW6C301C	6 PK 1055	97WF6C301A	6 PK 1432
924F8620AA	4 PK 1485	95VW6C301J	7 PK 1290	97WF6C301B	6 PK 1570
924F8620BA	4 PK 1520	95VW6C301K	7 DPK 1360	97WF6C301C	6 PK 1900
928F6C301A1	6 PK 913	95VW6K254C	128ST	988M6268A2A	ZRK 1184
928F6C301C1	6 PK 1900	95VW6K254D	128ST	988M6268A2B	ZRK 1184
928F6C301C1	6 PK 1900	95WF6C301C	6 PK 1432	988M6K254AB	327ST
928F6C301C2	6 PK 1900	95WF6C301E	6 PK 1570	988M6K254AC	327ST
928F6C301E1	6 PK 1540	95WF6C301G	6 PK 1755 TM	988M6K254AD	327ST
928F6C301E2	6 PK 1540	95WF6C301H	6 PK 1900	988M6K254AE	327ST
928M6268A1B	ZRK 1434	9640115880	6 PK 800	98BB6C301AA	6 PK 1975
928M6268A2C	ZRK 1434	9640115980	6 PK 800	98BB6C301BA	6 PK 2100
928M6268A2D	ZRK 1434	9642383780	6 PK 975	98BB6C301CA	6 PK 2120
928M6K254AC	307ST	9642383980	6 PK 975	98FF6C301CD	6 PK 1413
928M6K254AC	322ST	9648968580	ZRK 1460	98FF6C301DD	6 PK 1718
928M6M250B	308UT	9659795080	ZRK 1460	98KB6C301AA	6 PK 1445
928M6M250D	309UT	9674247880	ZRK 1592	98MF6C301B	6 PK 1740
928X6C301A1	6 PK 913	96FB6C301AC	6 PK 858	98MF6C301C	6 PK 1890
928X6C301C1	6 PK 1900	96FB6C301BC	6 PK 1735	98MF6C301D	6 PK 1915
92FF6C301A2	3 PK 675	96FB6C301CD	6 PK 1440	98MM6K254A	231ST
92FF6C301BB	5 PK 710	96FF6268DB	ZRK 1000	98MM6K254A	231ST
92FJ6C301A2	3 PK 675	96FF6C301A2	5 PK 1015	98MM6K254A	231ST



Teilenummer Part number	Abmessung Dimension
----------------------------	------------------------

Teilenummer Part number	Abmessung Dimension
----------------------------	------------------------

Teilenummer Part number	Abmessung Dimension
----------------------------	------------------------

**FORD**

98MM6K254A	231ST
98MM6K254B	231ST
98MM6K254B	231ST
98MM6K254B	231ST
98MM6K254B	231ST
98VW6A359C	6 DPK 1195
9936621040	6 PK 1038
9M5Q6K288A	ZRK 1592
9S518620AA	4 PK 665
9S518620BA	5 PK 1145
9S518620CA	6 PK 1185
A850X8620AH	AVX 10 x 1325
A86AX6C301A	AVX 13 x 850
A86AX6C301B	AVX 10 x 625
BM5G6K288A	ZRK 1172
C5NE8620B	AVX 13 x 1400
C9NN10C318	AVX 13 x 1400
C9NN10C318	AVX 13 x 1400
D2AE8A615FA	AVX 13 x 1075
D2NN8620A	AVX 13 x 1450
D3NN10C318	AVX 13 x 1400
D3NN10C318	AVX 13 x 1400
D4NN10C318	AVX 13 x 1400
D5NN10C318	AVX 13 x 825
D5NN8620C	AVX 13 x 1175
D6NN8620A	AVX 13 x 1175
D6NN8620A	AVX 13 x 1175 TM
D6NN8620B	AVX 13 x 1475
D6NN8620B	AVX 13 x 1475 TM
D8NN10C318	AVX 13 x 1450
E3EE6268A1A	ZRK 1039
E3EE6268A2A	ZRK 1039
EJ4K1010	4 PK 1015
EJ6K1350	6 PK 1352
EJ6K1415	6 PK 1413
EJ6K1654	6 PK 1655
F3226268A	ZRK 1210
F32Z8620A	5 PK 1030
F32Z8620B	4 PK 920
F32Z8620C	5 PK 1165
F32Z8620J	5 PK 1015
F32Z8620K	4 PK 920
F3DE8620C1A	6 PK 2155
F53E8620AB	6 PK 1820
F53E8620AP	6 PK 1820
F53E8620BB	6 PK 1590
F53E8K543AA	3 PK 685
F53E8K543AB	3 PK 685
F72Z6K254BA	186UT
F7PE8620AA	6 PK 2155
F7PE8620BA	6 PK 2075
F7PE8620BB	6 PK 2075
F83E8620AA	6 PK 1820
F89E8620CB	6 PK 2176
FS0515909	5 PK 1165
FS1115907	5 PK 1030
FS1218381A	4 PK 920
KL1118381B	5 PK 860
KLG415908	5 PK 1015
RF0112205A	ZRK 1225
V68HF6268AA	ZRK 1143
V701M8620AA	AVX 10 x 800
V81EB8A615A	AVX 10 x 980
V81EB8A615A	AVX 11,9 x 982
V86BB6C301A	AVX 10 x 900

**FORD**

V86BB8A615A	AVX 13 x 915
V90HF6C301A	6 PK 1413
V90HF6C301B	AVX 10 x 900
V92HF6C301A	4 PK 985
V93XF6C301A	6 PK 1650
V93XF6C301B	6 PK 1655
V94BF6C301A	4 PK 825
V94BF6C301B	4 PK 860
V97MF6C301A	6 PK 1751
V97MF6C301B	6 PK 1930
VX028109244	111UT
VX028145278	114SR
XF2E8620JA	6 PK 2155
XF2E8620JB	6 PK 2160
XL2E8620BA	6 PK 2191
XM216268BA	ZRK 1338
XM216B260AA	151ST
XM216K254AA	159ST
XM216K297AA	160UT
XM346268BA	ZRK 1168
XM346K254CA	953ST
XM346M250A	954UT
XM348620AA	AVX 13 x 1100
XM348620BA	AVX 13 x 1100
XS2E8620HB	6 PK 2080
XS2E8620MA	6 PK 1820
XS2E8620MB	6 PK 1820
XS2E8620NA	6 PK 1820
XS4Q6B217A	329ST
XS4Q6K288A	ZRK 1353
XS4Q6K288A	ZRK 1353
XS6E6C301BB	6 PK 1700
XS6E6C301JA	6 PK 1940
XS6E6C301JB	6 PK 1940
XS7E6C301C	4 PK 735
XS7G6M250A	555UT
XS7G6M250B	555UT
YC1E6C301A	7 PK 2710 TM
YC1E6C301B	7 PK 2875 TM
YC1E6C301C	7 PK 2710 TM
YC1E6C301D	7 PK 2875 TM
YM216B260AA	161ST
YM216C301C	6 DPK 1320
YM216C301E	6 PK 1265
YM216K254C	152ST
YS4J6K228CA	KT 1035
YS4J6K228DA	KT 1035
YS4J6K288BA	KT 1036
YS4J6K288BS	KT 1006
YS4Q6K254A	249ST
YS4Q6M260A	KT 1319
YS6E6C301AB	6 PK 1610
YS6E6C301BB	6 PK 1685
YS7J6268AB	KT 1011
YS7J6268CA	KT 1529

**FORD OTOSAN**

105E8620	AVX 10 x 750
----------	--------------

**FORD USA**

6C1Q6C301FA	6 PK 2205
JK6812A	6 PK 2050
JK6973	6 PK 2460
JK6991AA	6 PK 2510

**FSO**

96001122	4 PK 698
GMB40750	4 PK 750

**GEELY**

E030000701	ZRK 1003
------------	----------

**GENERAL MOTORS**

08857124	AVX 10 x 913
09966579	AVX 10 x 1235
09966580	AVX 10 x 1225
09966581	AVX 10 x 1425
09966582	AVX 10 x 1325
09966583	AVX 10 x 1125
09966584	AVX 10 x 1275
24426500	519ST
24436052	426UT
24447794	425ST
24447797	425ST
24451896	ZRK 1024
55212159	371ST
55350580	506UT
55352713	418UT
55353810	396ST
55555653	425ST
55560082	425ST
55562217	425ST
55562218	425ST
55570289	425ST
55570290	425ST
55574864	425ST
5636344	ZRK 1466
636728	KT 1461
90006259	AVX 10 x 875
90169083	AVX 10 x 950
90169520	AVX 10 x 970
90180131	500UT
90183426	AVX 10 x 875
90183440	AVX 10 x 913
90264022	501UT
90271857	AVX 10 x 1000
90323501	502ST
90323503	503UT
90324097	508UR
90353176	510ST
90354783	510ST
90406610	AVX 10 x 1000
90409800	AVX 10 x 940
90410386	AVX 10 x 888
90411769	518ST
90411773	505UT
90411774	515ST
90411782	509UT
90411787	504UT
90412115	AVX 10 x 920
90412711	ZRK 1024
90412730	506UT
90412731	507UT
90412783	519ST
90466474	525UT
90499401	510ST
90502286	AVX 10 x 925
90509168	219SR
90509750	210SR
90511911	210SR
90528200	518ST

Teilenummer Part number	Abmessung Dimension	Teilenummer Part number	Abmessung Dimension	Teilenummer Part number	Abmessung Dimension
<b>GENERAL MOTORS</b>		<b>GENERAL MOTORS</b>		<b>GENERAL MOTORS</b>	
90528603	395ST	9128739	506UT	97376296	436UT
90529187	525UT	9128740	507UT	98014186	ZRK 1081
90529188	525UT	9128741	504UT	<b>GREAT WALL</b>	
90529801	ZRK 1330	9129061	ZRK 1330	SMD182294	ZRK 1180
90529809	ZRK 1330	91580003	518ST	<b>HANOMAG</b>	
90529810	223UT	9158004	515ST	3002569X1	AVX 13 x 1550
90530123	519ST	9161179	ZRK 1332	3002569X1	AVX 13 x 1550 TM
90530124	518ST	9162101	KT 1229	3002585X1	AVX 13 x 1250
90530125	515ST	9162107	KT 1340	3002585X1	AVX 13 x 1250 TM
90530126	395ST	9201527	KT 1392	<b>HONDA</b>	
90530598	ZRK 1025	9201537	398ST	06141P28305	ZRK 1163
90531677	ZRK 1292	9201540	399UT	06141P50305	ZRK 1171
90531679	ZRK 1024	9202478	510ST	06141PK1305	ZRK 1117
90531680	ZRK 1024	92062969	ZRK 1256	13405PAAA01	ZRK 1152
90531682	ZRK 1291	92063917	ZRK 1291	13405PAAA02	ZRK 1152
90531857	ZRK 1330	92065368	396ST	13405PAAA03	ZRK 1152
90541734	210SR	92065902	ZRK 1256	13405PT0004	ZRK 1152
90542860	525UT	92066312	ZRK 1291	13405PTO004	ZRK 1152
90543739	525UT	9240033	418UT	14320P5TG00	ZRK 1076
90543873	219SR	93160237	346ST	14325P5TG00	338ST
90570371	ZRK 1023	93160244	342ST	14400634003	ZRK 1033
90570525	510ST	93161478	KT 1434	14400634004	ZRK 1033
90570913	507UT	93161859	KT 1392	14400634005	ZRK 1033
90710530	511ST	93161860	ZRK 1462	14400634005E	ZRK 1033
91017576	AVX 10 x 1300	93174120	KT 1024	14400634012	ZRK 1033
91031186	AVX 10 x 750	93174260	KT 1030	14400634014	ZRK 1033
91073827	AVX 10 x 1375	93174261	KT 1030	144006340141	ZRK 1033
91073828	AVX 10 x 1400	93174262	KT 1025	14400657000	ZRK 1037
91073829	AVX 10 x 1425	93174263	KT 1323	14400657004	ZRK 1037
91073835	AVX 13 x 1325	93174265	KT 1385	14400657014	ZRK 1037
91074366	AVX 10 x 1225	93174266	KT 1159	144006570140	ZRK 1037
91078110	AVX 10 x 1235	93174267	KT 1384	14400657024	ZRK 1038
91078589	AVX 13 x 1000	93178807	421UT	144006570242	ZRK 1038
91079521	AVX 10 x 1125	9317881	ZRK 1540	14400657024E	ZRK 1038
91079525	AVX 10 x 1275	93178812	ZRK 1466	14400P08004	ZRK 1160
91079526	AVX 10 x 1275	93178816	371ST	14400P0A004	ZRK 1062
91079529	AVX 10 x 1325	93180219	KT 1024	14400P13004	ZRK 1408
9108204	357ST	93180815	ZRK 1455	14400P13014	ZRK 1408
91082710	AVX 10 x 1400	93181966	371ST	14400P14004	ZRK 1181
9109416	298ST	93183572	KT 1329	14400P1GE01	ZRK 1160
9109428	KT 1392	93185336	ZRK 1540	14400P1HE01	ZRK 1163
9109430	398ST	93185844	KT 1468	14400P1JE01	ZRK 1165
9109489	631UT	93185845	KT 1207	14400P1KE01	ZRK 1166
9109601	ZRK 1195	93186866	371ST	14400P28004	ZRK 1163
9109609	602ST	93187032	631UT	14400P2A004	ZRK 1160
91102785	AVX 10 x 1150	93188125	KT 1002	14400P2E004	ZRK 1163
9110631	298ST	93188126	KT 1002	14400P2T004	ZRK 1179
9110632	299UT	93188128	KT 1425	14400P45G00	ZRK 1171
9110639	631UT	93188130	KT 1427	14400P45G01	ZRK 1171
9110690	603UT	93188133	KT 1027	14400P5TG00	ZRK 1077
9111144	359UT	93188135	KT 1421	14400P72004	ZRK 1400
9111270	603UT	93191277	KT 1426	14400P72014	ZRK 1400
91125789	AVX 10 x 1425	93191278	KT 1400	14400P7A004	ZRK 1396
91158706	KT 1434	94111624	AVX 13 x 1500	14400P7J004	ZRK 1066
91160164	346ST	94149432	516ST	14400P8AA01	ZRK 1446
91160164	602ST	94382214	521ST	14400P8AA02	ZRK 1446
9118848	219SR	94382215	522UT	14400PAAA01	ZRK 1062
9120501	KT 1461	96440343	ZRK 1595	14400PAAA02	ZRK 1062
9128444	524UT	97112438	520ST	14400PC0004	ZRK 1308
9128516	519ST	97114552	520ST	14400PC0004	ZRK 1308
9128656	519ST	97129939	436UT	14400PC0004	ZRK 1308
9128722	ZRK 1256	97212727	ZRK 1081	14400PC6004	ZRK 1119
9128724	ZRK 1024	97212728	ZRK 1081		
9128725	ZRK 1023	97227192	ZRK 1440		
9128736	509UT	97309459	436UT		



Teilenummer Part number	Abmessung Dimension
----------------------------	------------------------

Teilenummer Part number	Abmessung Dimension
----------------------------	------------------------

Teilenummer Part number	Abmessung Dimension
----------------------------	------------------------

**HONDA**

14400PC6004	ZRK 1119
14400PC6004	ZRK 1119
14400PDAE01	ZRK 1062
14400PE0003	ZRK 1109
14400PE0004	ZRK 1109
14400PE0004	ZRK 1109
14400PE3004	ZRK 1109
14400PEO003	ZRK 1109
14400PEO004	ZRK 1109
14400PH7004	ZRK 1199
14400PH7014	ZRK 1199
14400PK1004	ZRK 1117
14400PK2004	ZRK 1178
14400PLA004	ZRK 1396
14400PLM014	ZRK 1431
14400PLZD00	ZRK 1440
14400PM3004	ZRK 1165
14400PM6004	ZRK 1166
14400PM7004	ZRK 1178
14400PMGE01	ZRK 1160
14400PMMA0	ZRK 1431
14400PMMA0	ZRK 1431
14400PO8004	ZRK 1160
14400PR3004	ZRK 1179
14400PT0004	ZRK 1171
14400PTO004	ZRK 1171
14400PY3004	ZRK 1200
14510634000	880ST
14510P08003	224ST
14510P08004	224ST
14510P2A003	224ST
14510P2A004	224ST
14510P2AJ01	224ST
14510P30003	391ST
14510P5TG00	336ST
14510PD2003	879ST
14510PD2004	879ST
14510PE0003	877ST
14510PE0005	877ST
14510PH1003	879ST
14510PH1004	879ST
14510PM7003	875ST
14510PM7004	875ST
14510PR3003	391ST
14510PR3004	391ST
14510PT0002	876ST
14510PT0003	876ST
14510PT0004	876ST
14520P2A305	224ST
14520P2A306	224ST
14520P5TG00	337UT
18515634670	AVX 13 x 915
185156346712	AVX 13 x 915
19111500155	AVX 10 x 600
19111551010	AVX 10 x 1075
19111551010	AVX 10 x 1075 TM
19111551020	AVX 10 x 1090
19111568040	AVX 10 x 1090
191115900601	AVX 10 x 1400
19111590960	AVX 10 x 900
191115909600	AVX 10 x 900
19230PHM004	5 PK 935
23100148003	AVX 10 x 1100
23100GC3004	AVX 10 x 690
31110634003	AVX 10 x 950

**HONDA**

31110657010	AVX 10 x 925
311106570100	AVX 10 x 935
311106570100	AVX 10 x 938
31110657013	AVX 10 x 925
31110671003	AVX 10 x 965
311106710030	AVX 10 x 960
31110671030	AVX 10 x 960
31110673003	AVX 10 x 875
31110679004	AVX 10 x 875
31110679014	AVX 10 x 875
31110680004	AVX 10 x 875
31110689003	AVX 10 x 975
31110P01003	4 PK 780
31110P01004	4 PK 780
31110P0BA01	6 PK 935
31110P0BA02	6 PK 935
31110P0BA11	6 PK 935
31110P0BA12	6 PK 935
31110P12A01	5 PK 950
31110P12A02	5 PK 950
31110P13003	6 PK 913
31110P1KE01	4 PK 790
31110P1KE03	4 PK 790
31110P1R003	5 PK 835
31110P1R004	5 PK 835
31110P2A003	4 PK 805
31110P2A004	4 PK 805
31110P2J003	4 PK 805
31110P2T003	4 PK 775
31110P2T004	4 PK 775
31110P30003	4 PK 775
31110P300030	4 PK 775
31110P30004	4 PK 775
31110P300040	4 PK 775
31110P30901	4 PK 780
31110P30902	4 PK 775
31110P3F004	4 PK 825
31110P44G03	5 PK 954
31110P5G003	5 PK 935
31110P5K003	6 PK 955
31110P5K004	6 PK 955
31110P5M003	6 PK 913
31110P5M004	6 PK 913
31110P72004	4 PK 790
31110P72902	4 PK 780
31110P73A01	4 PK 763
31110P75004	4 PK 790
31110PA0003	AVX 10 x 925
31110PA0004	AVX 10 x 925
31110PA1740	AVX 10 x 950
31110PA1741	AVX 10 x 950
31110PA1742	AVX 10 x 950
31110PA6003	AVX 10 x 940
31110PA6003	AVX 10 x 950
31110PA6004	AVX 10 x 940
31110PA6004	AVX 10 x 950
31110PA6660	AVX 10 x 975
31110PA6661	AVX 10 x 965
31110PA6662	AVX 10 x 965
31110PA6910	AVX 10 x 990
31110PA6911	AVX 10 x 970
31110PA6911	AVX 10 x 975
31110PA6912	AVX 10 x 975
31110PB1003	AVX 10 x 960
31110PB1003	AVX 10 x 965

**HONDA**

31110PC1003	3 PK 975
31110PC5000	AVX 10 x 950
31110PC6305	AVX 10 x 940
31110PCXG01	6 PK 1138
31110PD2003	4 PK 950
31110PD2004	4 PK 950
31110PDAE01	6 PK 950
31110PE0003	3 PK 740
31110PE0004	3 PK 740
31110PE0004	3 PK 740
31110PE8601	3 PK 960
31110PE8602	3 PK 960
31110PE9210	AVX 10 x 900
31110PE9921	AVX 10 x 875
31110PFB003	3 PK 668
31110PG6003	3 PK 715
31110PG6004	3 PK 715
31110PG6030	3 PK 715
31110PG7661	3 PK 715
31110PG7661	3 PK 715
31110PH0003	5 PK 935
31110PH2003	5 PK 935
31110PH2004	5 PK 935
31110PH2004	5 PK 935
31110PH2J01	5 PK 935
31110PH3003	3 PK 805
31110PH3004	3 PK 805
31110PH3004	3 PK 805
31110PH3J01	3 PK 805
31110PH6003	3 PK 805
31110PH6004	3 PK 805
31110PH7003	3 PK 1080
31110PH7003	3 PK 1080
31110PH7004	3 PK 1080
31110PH7013	3 PK 1080
31110PH9004	AVX 10 x 864
31110PJ70030	3 PK 690
31110PJ70040	3 PK 690
31110PJ70130	3 PK 715
31110PJ70140	3 PK 715
31110PJ7505	3 PK 715
31110PK2003	5 PK 880
31110PK2004	5 PK 880
31110PLAE01	6 PK 858
31110PLAE02	6 PK 858
31110PLR003	6 PK 985
31110PLZD00	6 PK 1275
31110PM3003	3 PK 763
31110PM3003	3 PK 763
31110PM3004	3 PK 763
31110PM3004	3 PK 763
31110PM3005	3 PK 763
31110PM3014	3 PK 763
31110PNEG01	7 PK 1385
31110PNEG02	7 PK 1385
31110PO1003	4 PK 780
31110PO1003	4 PK 780
31110PO1004	4 PK 780
31110PP4E01	3 PK 785
31110PP4E01	3 PK 785
31110PR3003	4 PK 775
31110PR3003	4 PK 775
31110PR3004	4 PK 775
31110PR4A05	4 PK 775
31110PR4A06	4 PK 775



Teilenummer Part number	Abmessung Dimension	Teilenummer Part number	Abmessung Dimension	Teilenummer Part number	Abmessung Dimension
<b>HONDA</b>		<b>HONDA</b>		<b>HONDA</b>	
31110PR5003	4 PK 763	38920P5L004	6 PK 1078	38920PR7A01	4 PK 980
31110PR7A01	5 PK 1104	38920P73003	4 PK 813	38920PR7A02	4 PK 980
31110PR7A12	5 PK 1104	38920P75A01	4 PK 870	38920PRA004	7 PK 1640
31110PRA013	7 PK 1280	38920P75A02	4 PK 870	38920PRA013	7 PK 1640
31110PT0003	5 PK 954	38920P8AA02	6 PK 1175	38920PSGT01	6 PK 995
31110PT0004	5 PK 954	38920P8CA02	6 PK 1175	38920PT0003	5 PK 1104
31110PV0003	4 PK 835	38920P8FA02	6 PK 1190	38920PT00032	5 PK 1104
31110PV0004	4 PK 835	38920P8FA04	6 PK 1190	38920PT0004	5 PK 1104
31110PVO004	4 PK 835	38920PAAA01	6 PK 1105	38920PV0003	4 PK 920
31110PWAG0	5 PK 850	38920PAAA02	6 PK 1105	38920PV0004	4 PK 920
31110PY3003	5 PK 935	38920PC0003	AVX 13 x 1125	38920PW0001	4 PK 845
31110PY3A01	5 PK 935	38920PC1951	AVX 13 x 1060	38920PW0003	4 PK 850
31110RRBA01	7 PK 1640	38920PC6003	AVX 13 x 950	38920PW0004	4 PK 850
311110634003	AVX 10 x 935	38920PC6004	AVX 13 x 950	38920PW0G0	4 PK 845
311110634003	AVX 10 x 938	38920PC6306	AVX 13 x 950	38920PW0G0	4 PK 845
31111634003	AVX 10 x 940	38920PCA003	6 PK 1078	38920PW0J01	5 PK 1155
31111657010	AVX 10 x 930	38920PCA004	6 PK 1078	38920PWA004	6 PK 1138
38763657810	AVX 10 x 1075	38920PCX004	6 PK 1470	38920PWA901	5 PK 1140
38763657810	AVX 10 x 1075 TM	38920PCX024	6 PK 1470	38920PWAJ01	5 PK 1155
38763671003	AVX 10 x 1050	38920PD2952	AVX 13 x 925	38920PY3003	5 PK 962
38763689003	AVX 10 x 1075	38920PD2954	AVX 13 x 950	38920PY3A01	5 PK 962
38763689003	AVX 10 x 1075 TM	38920PDAE01	6 PK 1105	38920RBBE01	7 PK 1750
38763PA0003	AVX 10 x 990	38920PDAE03	6 PK 1105	38920RBBE02	7 PK 1750
38763PA0004	AVX 10 x 990	38920PE0013	AVX 13 x 850	38920RBDE01	7 PK 2271
38763PA0004	AVX 10 x 990	38920PE1701	AVX 13 x 810	38920RBDE02	7 PK 2271
38763PA6003	AVX 10 x 975	38920PE1711	AVX 13 x 850	38920RBDE03	7 PK 1785
38763PA6004	AVX 10 x 975	38920PEC003	4 PK 805	38920RBDE04	7 PK 1785
38763PB3003	AVX 10 x 1075	38920PEC004	4 PK 805	38920RCAA03	6 PK 2140
38763PB3003	AVX 10 x 1075 TM	38920PFB004	3 PK 668	38920RCAA05	6 PK 2140
38763PB3004	AVX 10 x 1075	38920PG6003	AVX 13 x 900	38920REAZ01	5 PK 1145
38763PB3004	AVX 10 x 1075 TM	38920PH1003	4 PK 913	394323100	AVX 13 x 975
38763PB3004	AVX 10 x 1090	38920PH3003	4 PK 913	39820PC3661	AVX 13 x 1100
38920657810	AVX 13 x 835	38920PH9003	AVX 13 x 785	39820PH1003	AVX 10 x 900
38920671003	AVX 13 x 800	38920PHM003	5 PK 1110	56092PE0003	AVX 10 x 888
38920678003	AVX 13 x 765	38920PJ5003	AVX 13 x 930	56992671000	AVX 10 x 685
389206790030	AVX 13 x 765	38920PJ59120	AVX 13 x 900	56992689004	AVX 10 x 685
38920P01003	4 PK 795	38920PJ6661	AVX 13 x 925	56992689004	AVX 10 x 690
38920P01004	4 PK 795	38920PK1003	5 PK 1055	56992692003	AVX 10 x 940
38920P04003	4 PK 850	38920PK1004	5 PK 1055	56992-692-004	AVX 10 x 935
38920P04004	4 PK 850	38920PL2013	4 PK 913	56992-692-004	AVX 10 x 938
38920P08003	4 PK 870	38920PLC003	6 PK 995	569926920040	AVX 10 x 940
38920P08004	4 PK 870	38920PLC004	6 PK 995	56992-692-004	AVX 10 x 935
38920P0A003	6 PK 1115	38920PLR003	6 PK 985	56992-692-004	AVX 10 x 938
38920P0A004	6 PK 1115	38920PLR004	6 PK 985	56992692013	AVX 10 x 940
38920P0AJ01	6 PK 1115	38920PLZD00	6 PK 1625	56992-692-013	AVX 10 x 935
38920P0AJ02	6 PK 1115	38920PM3003	4 PK 870	56992-692-013	AVX 10 x 938
38920P13J01	6 PK 1045	38920PM3003	4 PK 870	569926920130	AVX 10 x 940
38920P14A01	5 PK 1070	38920PM3014	4 PK 870	56992-692-013	AVX 10 x 935
38920P14A02	5 PK 1070	38920PM3014	4 PK 870	56992-692-013	AVX 10 x 938
38920P1E003	6 PK 1090	38920PM5A11	4 PK 870	56992692014	AVX 10 x 940
38920P1EJ01	6 PK 1090	38920PM5A12	4 PK 870	56992P02003	4 PK 813
38920P1EJ02	6 PK 1090	38920PMET01	6 PK 985	56992P02004	4 PK 813
38920P1R003	5 PK 935	38920PNA003	7 PK 1775	56992P04004	4 PK 1065
38920P1R004	5 PK 935	38920PNA004	7 PK 1775	56992P04J02	4 PK 1065
38920P2A003	4 PK 825	38920PNB003	7 PK 1730	56992P0A003	4 PK 1065
38920P2T003	4 PK 845	38920PNB004	7 PK 1730	56992P0A004	4 PK 1065
38920P30003	4 PK 835	38920PO1003	4 PK 795	56992P0AA01	4 PK 1065
38920P30004	4 PK 835	38920PO1004	4 PK 795	56992P0AJ01	4 PK 1065
38920P30505	4 PK 835	38920PO8003	4 PK 870	56992P0AJ02	4 PK 1065
38920P3F003	4 PK 845	38920PO8004	4 PK 870	56992P11003	4 PK 1020
38920P3F004	4 PK 845	38920PP4E01	4 PK 813	56992P13003	4 PK 1020
38920P54003	4 PK 813	38920PP4E02	4 PK 813	56992P1JE01	4 PK 845
38920P54004	4 PK 813	38920PR3003	4 PK 835	56992P1KE03	4 PK 813
38920P5A004	5 PK 954	38920PR3003	4 PK 835	56992P2A003	4 PK 845
38920P5L003	6 PK 1078	38920PR3004	4 PK 835	56992P2A004	4 PK 845



Teilenummer Part number	Abmessung Dimension
----------------------------	------------------------

Teilenummer Part number	Abmessung Dimension
----------------------------	------------------------

Teilenummer Part number	Abmessung Dimension
----------------------------	------------------------

**HONDA**

56992P2T003	4 PK 875
56992P2T004	4 PK 875
56992P30003	4 PK 870
56992P30004	4 PK 870
56992P3F003	4 PK 900
56992P45G01	4 PK 1075
56992P5G003	4 PK 950
56992P5K003	4 PK 1050
56992P5K004	4 PK 1050
56992P5TG00	6 PK 1185
56992P5TG01	6 PK 1185
56992P5TG20	6 PK 1460
56992P72003	4 PK 920
56992P72004	4 PK 920
56992P76003	4 PK 1020
56992P8AA01	4 PK 1110
56992PA6003	AVX 10 x 925
56992PA6004	AVX 10 x 925
56992PAAA01	4 PK 1065
56992PC6003	AVX 10 x 900
56992PC6004	AVX 10 x 900
56992PC6014	AVX 10 x 900
56992PDAE01	4 PK 1065
56992PDEE01	4 PK 1020
56992PE0003	AVX 10 x 888
56992PEJ004	3 PK 890
56992PG6003	AVX 10 x 900
56992PG6004	AVX 10 x 900
56992PH1003	AVX 10 x 900
56992PH1004	AVX 10 x 900
56992PH3004	AVX 10 x 913
56992PH7003	AVX 10 x 1050
56992PK1003	4 PK 980
56992PK1004	4 PK 980
56992PK1013	4 PK 980
56992PL2003	AVX 10 x 1075
56992PL2003	AVX 10 x 1075 TM
56992PL29010	AVX 10 x 1090
56992PLM003	4 PK 1015
56992PLM004	4 PK 1015
56992PM3003	AVX 10 x 785
56992PM7003	AVX 10 x 800
56992PM7004	AVX 10 x 800
56992PO2003	4 PK 813
56992PO2004	4 PK 813
56992-PP5-E0	AVX 10 x 935
56992-PP5-E0	AVX 10 x 938
56992PP5E02	AVX 10 x 940
56992-PP5-E0	AVX 10 x 935
56992-PP5-E0	AVX 10 x 938
56992PSA004	4 PK 1030
56992PT0003	4 PK 1050
56992PT0004	4 PK 1050
56992PT0J01	4 PK 1075
56992PT0J02	4 PK 1075
56992PT0J01	4 PK 1075
56992PT0J02	4 PK 1075
56992PV0003	4 PK 735
56992PV0004	4 PK 735
56992PY3004	4 PK 950
8763PA6003	AVX 10 x 975
89206920130	AVX 13 x 875
894382106	4 PK 966
91920PL2013	4 PK 913
9194009101	4 PK 913

**HONDA**

GTB2003	ZRK 1077
GTB2004	ZRK 1076
XHM460	ZRK 1199

**HYUNDAI**

0K88R12205	ZRK 1403
0K88R15987	5 PK 1680
2312724001	AVX 13 x 850
2312728100	4 PK 913
2312728240	4 PK 940
2312733300	4 PK 962
2312736000	AVX 13 x 975
2335632010	ZRK 1388
2335632020	ZRK 1388
2335632030	ZRK 1388
2335632050	ZRK 1388
2335633110	ZRK 1459
2335633120	ZRK 1459
2335633130	ZRK 1459
2335633140	ZRK 1459
2335633150	ZRK 1459
2335633160	ZRK 1459
2335638000	ZRK 1578
2335638010	ZRK 1578
2335638011	ZRK 1578
2335638020	ZRK 1578
2335642011	ZRK 1277
2335642200	ZRK 1153
2335642500	ZRK 1202
2335732000	931UT
2335732010	931UT
2335732020	931UT
2335732030	931UT
2335732040	931UT
2335732050	330UT
2335733120	850UT
2335733130	850UT
2335733350	166UT
2335738001	166UT
2335742010	929ST
2335742020	929ST
2335742030	929ST
2431202701	ZRK 1070
2431221040	ZRK 1036
2431222010	ZRK 1156
2431222611	ZRK 1333
2431222612	ZRK 1333
2431222613	ZRK 1333
2431223001	ZRK 1169
2431223002	ZRK 1169
2431223201	ZRK 1170
2431223202	ZRK 1170
2431223400	ZRK 1170
2431224000	ZRK 1017
2431224010	ZRK 1017
2431224050	ZRK 1017
2431226000	ZRK 1164
2431226001	ZRK 1164
2431226050	ZRK 1164
2431227000	ZRK 1454
2431227250	ZRK 1454
2431232555	ZRK 1175
2431232560	ZRK 1174
2431232610	ZRK 1285
2431232620	ZRK 1285

**HYUNDAI**

2431232820	ZRK 1259
2431233010	ZRK 1193
2431233020	ZRK 1193
2431233030	ZRK 1193
2431233060	ZRK 1193
2431233110	ZRK 1329
2431233120	ZRK 1329
2431233130	ZRK 1329
2431233140	ZRK 1329
2431233150	ZRK 1329
2431233160	ZRK 1329
2431235000	ZRK 1192
2431237100	ZRK 1704
2431237400	ZRK 1704
2431237500	ZRK 1704
2431238010	ZRK 1073
2431238020	ZRK 1073
2431238210	ZRK 1429
2431238220	ZRK 1429
2431542101	ZRK 1260
2431542200	ZRK 1522
2431742000	927ST
2431742010	927ST
2431742020	927ST
2441002510	296ST
2441002550	296ST
2441021010	925ST
2441021014	925ST
2441022000	178ST
2441022020	178ST
2441023011	185UT
2441023400	185UT
2441023500	185UT
2441026000	178ST
2441032000	192ST
2441032010	192ST
2441032020	192ST
2441032040	192ST
2441035000	194ST
2441035010	194ST
2441035020	194ST
2441035060	194ST
2481023011	184UT
2481023050	184UT
2481023400	184UT
2481023500	184UT
2481026010	444UT
2481026020	444UT
2481033021	189UT
2481033024	189UT
2481038001	189UT
2521111000	AVX 10 x 813
2521121000	AVX 10 x 875
2521132000	AVX 10 x 965
2521202500	4 PK 775
2521202550	4 PK 780
2521203010	5 EPK 898
2521221200	4 PK 870
2521221220	4 PK 870
2521222020	4 PK 900
2521222030	4 PK 900
2521223000	4 PK 875
2521223020	4 PK 875
2521223700	4 PK 890
2521224320	4 PK 870



Teilenummer Part number	Abmessung Dimension
----------------------------	------------------------

Teilenummer Part number	Abmessung Dimension
----------------------------	------------------------

Teilenummer Part number	Abmessung Dimension
----------------------------	------------------------

**HYUNDAI**

2521224350	4 PK 870
2521225000	6 PK 2585
2521225020	6 PK 2510
2521226000	4 PK 850
2521226001	4 PK 845
2521227000	6 PK 1515
2521227001	6 PK 1515
2521227002	6 PK 1515
2521227010	6 PK 1515
2521227160	6 PK 1400
2521227400	6 PK 1515
2521227501	6 PK 1440
2521227502	6 PK 1440
2521227551	6 PK 1440
2521227552	6 PK 1395
252122A001	5 PK 1790
252122A112	5 PK 1850
252122A120	5 PK 1800
252122A121	5 PK 1800
252122B020	6 PK 1255
252122B030	6 PK 955
2521232510	4 PK 980
2521232520	4 PK 980
2521232550	4 PK 980
2521233000	4 PK 980
2521233050	4 PK 980
2521233060	4 PK 980
2521233100	4 PK 995
2521233150	4 PK 995
2521233160	4 PK 995
2521235010	5 PK 1240
2521235020	5 PK 1240
2521235050	5 PK 1240
2521236070	5 PK 1345
2521237101	6 PK 2000
2521237102	6 PK 2000
2521237110	6 PK 2000
2521237111	6 PK 2000
2521237160	6 PK 1700
2521237161	6 PK 1700
2521237162	6 PK 1695
2521237181	6 PK 2000
2521238000	4 PK 950
2521238001	4 PK 950
2521239800	5 PK 1130
252123C100	6 PK 2475
252123E000	6 PK 2055
252124A000	7 PK 2283
252124A010	7 PK 1730
252124A100	7 PK 2271
3733029000	6 PK 1130
3733029100	6 PK 1740
3733029102	6 PK 1740
57161H1300	4 PK 1080
57161H1500	4 PK 835
5717002710	4 PK 750
571702D000	3 PK 668
571702D101	3 PK 675
5717038000	5 PK 1110
5717038010	5 PK 1390
5717039000	5 PK 905
571814A000	4 PK 1060
5723122000	4 PK 615
5723123500	4 PK 635
5723124000	AVX 13 x 625

**HYUNDAI**

5723128000	AVX 13 x 625
5723129050	4 PK 615
88R12205	ZRK 1403
96188881	6 PK 1740
96209043	6 PK 1130
9771302000	4 PK 675
9771322000	4 PK 875
9771322060	4 PK 835
9771322260	4 PK 825
9771322261	4 PK 813
9771323300	4 PK 950
9771326300	6 PK 1195
9771328240	4 PK 940
9771329000	4 PK 850
9771329500	4 PK 850
977132D000	4 PK 813
977132D100	4 PK 855
977132D510	4 PK 855
9771333340	4 PK 962
9771339850	6 PK 1230
997132E000	4 PK 855
MD113564	ZRK 1017
MD116786	ZRK 1017
OK88R12205	ZRK 1403

**INNOCENTI**

33402327	AVX 10 x 813
46406340	4 PK 940
46408751	ZRK 1244
46456894	4 PK 962
46537099	4 PK 962
46542302	4 PK 962
46770220	5 PK 886
71719174	4 PK 913
7670173	5 PK 1000
7732138	5 PK 886
7750728	3 PK 685
7765719	5 PK 886
AAE3550	AVX 10 x 813

**INTERNATIONAL HARV.**

118094R1	AVX 10 x 800
3132523R1	AVX 10 x 1225
3136257R1	AVX 13 x 1325
3136257R1	AVX 13 x 1325 TM
3136258R1	AVX 13 x 1350 TM
3138935R1	AVX 13 x 1425
3138935R1	AVX 13 x 1425 TM
3139157R1	AVX 13 x 1575
3139157R1	AVX 13 x 1575 TM
3218043R1	AVX 13 x 1125
3218043R1	AVX 13 x 1125 TM
32181050	AVX 10 x 625
3218951R1	AVX 13 x 1350 TM
3218952R1	AVX 13 x 1425
3218952R1	AVX 13 x 1425 TM
716415R1	AVX 10 x 1250
716417R1	AVX 10 x 1300
717356R91	AVX 10 x 1250

**ISUZU**

1136710180	AVX 13 x 1300
1136710300	AVX 13 x 1675
1136710410	AVX 13 x 915
1136710490	AVX 13 x 1300

**ISUZU**

1136711030	AVX 13 x 1350
1136711040	AVX 13 x 1350
1136711770	AVX 13 x 1475
1136711780	AVX 13 x 1475
1136712110	AVX 13 x 1450
1136712120	AVX 13 x 1450
1136713010	AVX 13 x 1450
1240553	ZRK 1050
1854733	6 PK 2285
1854734	6 PK 2040
1987947654	AVX 13 x 925
31110P01003	4 PK 780
31110P01004	4 PK 780
38920P01003	4 PK 795
38920P010031	4 PK 795
38920P01004	4 PK 795
4300342	AVX 13 x 1500
4300516	ZRK 1050
4304099	ZRK 1269
5125360160	ZRK 1269
5136710040	AVX 10 x 1075
5136710040	AVX 10 x 1075 TM
5136710260	AVX 10 x 775
5136710410	AVX 10 x 1200
5136710411	AVX 10 x 1200
5136710480	AVX 13 x 915
5136710620	AVX 10 x 1200
5136710710	AVX 10 x 1050
5136710780	AVX 13 x 1700
5136710820	AVX 10 x 1200
5136710880	AVX 13 x 1300
5136710900	AVX 13 x 1700
5136711060	AVX 13 x 1500
5136711110	AVX 13 x 1400
5136711130	AVX 13 x 1500
5136711140	AVX 13 x 1575
5136711150	AVX 13 x 1575
5136711160	AVX 13 x 1015
5136711160	AVX 13 x 1015 TM
5136711230	AVX 13 x 1300
5136711270	AVX 10 x 1175
5136711280	AVX 10 x 1175
5136711330	AVX 10 x 1200
5136711380	AVX 10 x 950
5136711560	AVX 10 x 940
5136741140	AVX 13 x 1575
56992P02003	4 PK 813
56992P02004	4 PK 813
5860001460	876ST
5860014030	4 PK 1065
5860077170	6 PK 1115
5860090350	4 PK 805
5860107930	4 PK 845
5866867210	6 PK 884
5867168190	6 PK 2000
5867237830	6 PK 1605
5867257200	6 PK 2000
5867257350	6 PK 2040
5897701710	AVX 10 x 990
636352	ZRK 1280
636366	ZRK 1280
636574	ZRK 1097
809218140	5 PK 880
809218250	5 PK 880
8940307610	AVX 13 x 1500



Teilenummer Part number	Abmessung Dimension
----------------------------	------------------------

Teilenummer Part number	Abmessung Dimension
----------------------------	------------------------

Teilenummer Part number	Abmessung Dimension
----------------------------	------------------------

**ISUZU**

8941077651	AVX 10 x 913
8941077970	AVX 13 x 785
8941077971	AVX 13 x 765
8941079930	AVX 10 x 1025
8941109930	AVX 10 x 1025
8941116240	AVX 13 x 1500
8941116870	AVX 13 x 875
894120507	ZRK 1280
8941245582	AVX 13 x 765
8941245583	AVX 13 x 765
8941251700	AVX 13 x 875
8941316311	AVX 13 x 765
894133971	ZRK 1097
8941339760	AVX 13 x 850
8941374780	4 PK 698
8941390670	4 PK 685
8941406270	AVX 10 x 613
8941417200	AVX 13 x 1000
8941417210	AVX 13 x 1025
8941462300	AVX 13 x 1525
8941464240	AVX 13 x 1525
8941474030	AVX 13 x 765
8941474031	AVX 13 x 765
8941474040	AVX 13 x 865
8941474041	AVX 13 x 865
8941509881	AVX 13 x 925
8941568210	ZRK 1050
8941576650	AVX 10 x 900
8941606560	ZRK 1050
8941675880	AVX 13 x 750
8941675890	AVX 13 x 900
8941675900	AVX 13 x 950
8941751700	AVX 13 x 875
8941761310	AVX 13 x 865
8942030820	AVX 13 x 925 TM
8942030820	AVX 13 x 950
8942046390	AVX 10 x 775
8942072290	AVX 10 x 775
8942118610	AVX 13 x 810
8942179190	AVX 13 x 950
8942179190	AVX 13 x 950 TM
8942179200	AVX 10 x 775
8942179210	AVX 10 x 775
8942185740	AVX 13 x 1025
8942187820	ZRK 1044
894220372A	ZRK 1050
8942210380	AVX 13 x 975
8942213270	AVX 13 x 915
8942218610	AVX 13 x 835
8942224690	AVX 13 x 750
8942228791	AVX 13 x 950
8942228800	AVX 13 x 875
8942252090	AVX 13 x 875
8942274180	AVX 13 x 1030
8942292690	AVX 13 x 992
8942292691	AVX 13 x 1000 TM
8942292691	AVX 13 x 992
8942322841	AVX 13 x 875
8942322871	AVX 10 x 763
8942322872	AVX 10 x 763
8942322873	AVX 10 x 775
8942323100	AVX 13 x 975
8942353910	AVX 13 x 835
8942523420	AVX 13 x 1375
8942523420	AVX 13 x 1375 TM

**ISUZU**

8943358490	4 PK 705
8943603920	4 PK 685
8943627320	6 PK 1045
8943645800	6 PK 950
8943795970	6 PK 962
8943801590	6 PK 962
894380679	ZRK 1097
8943806790	ZRK 1097
8943821060	4 PK 966
8943821071	4 PK 805
8943822140	521ST
8943822151	522UT
894385561	ZRK 1280
8944118600	AVX 13 x 925
894419856	ZRK 1097
8944198560	ZRK 1097
8944273530	AVX 13 x 835
8944338200	522UT
8944349260	AVX 13 x 1525
8944400100	AVX 13 x 1500
8944411480	6 PK 1035
8944411500	6 PK 935
894449930	ZRK 1280
8944499307	ZRK 1280
8944503950	AVX 13 x 1450
8944529040	AVX 13 x 1025
8944680621	6 PK 750
8970105301	511ST
8970163260	ZRK 1235
8970417840	ZRK 1050
8970438660	6 PK 1100
8970631740	6 PK 1540
8970659860	ZRK 1097
8971124380	520ST
8971145520	520ST
8971299391	436UT
8971305610	6 PK 2040
8971863950	6 PK 1250
8972127270	ZRK 1081
8972271920	ZRK 1440
8972290710	6 PK 1590
8973094591	436UT
8973261400	6 PK 1625
8973629260	7 PK 990
8973858450	6 PK 1250
8973858460	6 PK 1610
8980000230	6 PK 1590
8980141860	ZRK 1081
8981077970	AVX 13 x 785
8981606490	AVX 13 x 875
8982185740	AVX 13 x 1400
8982314130	AVX 13 x 810
9136711860	AVX 10 x 864
9136711910	AVX 13 x 1300
9136711940	AVX 10 x 900
9136712020	AVX 10 x 875
9136712160	AVX 13 x 992
9136712660	AVX 10 x 888
9136712940	AVX 10 x 763
9136713290	AVX 13 x 1475
9136713310	AVX 13 x 1450
9136716140	AVX 13 x 950
9136716150	AVX 13 x 1015
9136716150	AVX 13 x 1015 TM
9136716160	AVX 13 x 992

**ISUZU**

9136716300	AVX 13 x 810
9136716310	AVX 13 x 865
9136716360	AVX 10 x 950
9136718010	AVX 13 x 1015
9136718010	AVX 13 x 1015 TM
9136718020	AVX 13 x 992
9136718070	AVX 13 x 835
9136718080	AVX 13 x 992
93891628	AVX 13 x 1025
94029834	ZRK 1269
94030761	AVX 13 x 1500
94141721	AVX 13 x 1025
94146423	AVX 13 x 1525
94156821	ZRK 1050
94160656	ZRK 1050
94232287	AVX 13 x 875
94256977	AVX 10 x 660
94257037	AVX 13 x 1000
94419856	ZRK 1097
94434926	AVX 13 x 1525
94440010	AVX 13 x 1500
97130560	6 PK 2285
97130561	6 PK 2040
9944710770	AVX 13 x 950

**IVECO**

01116061	AVX 13 x 900
01116061	AVX 13 x 900 TM
01119276	AVX 13 x 1075 TM
01161683	AVX 13 x 1100 TM
01161989	AVX 13 x 950
01161989	AVX 13 x 950 TM
01168303	AVX 10 x 1050
01168328	AVX 13 x 1325
01168328	AVX 13 x 1325 TM
01175745	AVX 10 x 975
02234343	AVX 10 x 1375
02235175	AVX 10 x 1300
02235176	AVX 10 x 1350
02235176	AVX 10 x 1350 TM
02235177	AVX 10 x 1400
02235178	AVX 10 x 1100
02235179	AVX 10 x 1125
02235180	AVX 10 x 1150
02235181	AVX 10 x 1175
02235531	AVX 10 x 1275
02235532	AVX 10 x 1340
02235533	AVX 10 x 1340
02235713	AVX 10 x 950
02237477	AVX 10 x 975
02416706	AVX 10 x 950
02419104	AVX 13 x 975
02419104	AVX 13 x 975 TM
02419105	AVX 13 x 1025
02419105	AVX 13 x 1025 TM
07301661	372ST
1119276	AVX 13 x 1075 TM
1161683	AVX 13 x 1100 TM
1161989	AVX 13 x 950
1161989	AVX 13 x 950 TM
127627	ZRK 1462
2235177	AVX 10 x 1400
2237477	AVX 10 x 975
2417875	AVX 13 x 975
2417875	AVX 13 x 975 TM



Teilenummer Part number	Abmessung Dimension	Teilenummer Part number	Abmessung Dimension	Teilenummer Part number	Abmessung Dimension
<b>IVECO</b>		<b>IVECO</b>		<b>IVECO</b>	
2418962	AVX 13 x 1075 TM	4830920	AVX 13 x 1275 TM	61689963	AVX 13 x 1425 TM
2419104	AVX 13 x 975	4830921	AVX 13 x 1675	8822704	AVX 13 x 1375
2419104	AVX 13 x 975 TM	4830921	AVX 13 x 1675 TM	8822704	AVX 13 x 1375 TM
2992484	359UT	4838527	AVX 13 x 1325	93419518	AVX 13 x 850
4147646	AVX 13 x 1050	4838527	AVX 13 x 1325 TM	9400831739	KT 1351
4147646	AVX 13 x 1050 TM	4843795	AVX 13 x 1675	98415921	ZRK 1316
41800219	AVX 13 x 1825	4843795	AVX 13 x 1675 TM	98419390	ZRK 1312
41800219	AVX 13 x 1825 TM	4843796	AVX 13 x 1400 TM	98419528	AVX 13 x 1100 TM
42520250	2/AVX 13 x 1050	4851358	AVX 13 x 1625	98420090	AVX 13 x 1675
42520250	AVX 13 x 1050	4851358	AVX 13 x 1625 TM	98420090	AVX 13 x 1675 TM
42520250	AVX 13 x 1050 TM	4854694	AVX 13 x 1200	98420262	AVX 13 x 1300
42522744	AVX 13 x 1050	4854694	AVX 13 x 1200 TM	98420262	AVX 13 x 1300 TM
42522744	AVX 13 x 1050 TM	4855023	AVX 13 x 1300	98420263	AVX 13 x 1300
4631961	AVX 13 x 1450 TM	4855023	AVX 13 x 1300 TM	98420263	AVX 13 x 1300 TM
4645910	AVX 13 x 1450	4860584	15 PK 954 TM	98420264	AVX 13 x 1290
4645910	AVX 13 x 1450 TM	4898546	8 PK 1230 TM	98420266	AVX 13 x 960
4645911	AVX 13 x 1450 TM	4898547	8 PK 1688 TM	98421395	AVX 13 x 1750
4645913	AVX 13 x 1450 TM	500317024	AVX 13 x 1275 TM	98421395	AVX 13 x 1750 TM
4708482	AVX 13 x 1200 TM	500323627	ZRK 1316	98424128	AVX 13 x 1525
4716471	AVX 13 x 1325	500324346	6 PK 1055	98424128	AVX 13 x 1525 TM
4716471	AVX 13 x 1325 TM	500328020	10 PK 1725 TM	98425938	AVX 13 x 1525
4722565	AVX 13 x 1675	500329310	4 PK 1015	98425941	AVX 13 x 1175
4722565	AVX 13 x 1675 TM	500341618	4 PK 1050	98425941	AVX 13 x 1175 TM
4726466	AVX 13 x 1200 TM	500341808	12 PK 1815 TM	98429196	AVX 13 x 1300
4726678	AVX 13 x 1350 TM	500341808	KT 7003	98429196	AVX 13 x 1300 TM
4727032	AVX 13 x 1825	500341810	12 PK 1830 TM	98429205	AVX 13 x 1350 TM
4727032	AVX 13 x 1825 TM	500352673	4 PK 1070 TM	98430540	AVX 13 x 1725
4732571	AVX 13 x 1025	500352673	4 PK 1075	98432109	AVX 13 x 992
4732571	AVX 13 x 1025 TM	500368902	6 PK 1055	98432111	AVX 13 x 1425
4732574	AVX 13 x 1025 TM	500370647	AVX 13 x 1200	98432111	AVX 13 x 1425 TM
4740847	357ST	500370647	AVX 13 x 1200 TM	98434369	AVX 13 x 1650
4745692	AVX 13 x 1475	500370648	AVX 13 x 1225	98434369	AVX 13 x 1650 TM
4745692	AVX 13 x 1475 TM	500370648	AVX 13 x 1225 TM	98434370	AVX 13 x 1500
4749444	AVX 13 x 1000 TM	500379179	AVX 13 x 1375	98434370	AVX 13 x 1500 TM
4749445	AVX 13 x 1000	500379179	AVX 13 x 1375 TM	98434371	AVX 13 x 1475
4749445	AVX 13 x 1000 TM	500385852	AVX 13 x 1050	98434371	AVX 13 x 1475 TM
4757583	AVX 13 x 1425	500385852	AVX 13 x 1050 TM	98434372	AVX 13 x 1250
4757583	AVX 13 x 1425 TM	500388688	459UT	98434372	AVX 13 x 1250 TM
4759595	AVX 13 x 1450 TM	504005526	8 PK 1158 TM	98434373	AVX 13 x 1125
4759597	AVX 13 x 1450 TM	504012393	4 PK 985	98434373	AVX 13 x 1125 TM
4776672	AVX 13 x 1475 TM	504015725	AVX 13 x 1300	98434375	AVX 13 x 1175
4786727	AVX 13 x 1425	504015725	AVX 13 x 1300 TM	98434375	AVX 13 x 1175 TM
4786727	AVX 13 x 1425 TM	504019980	5 PK 1104	98434544	AVX 13 x 1700
4799021	AVX 13 x 1060	504020489	4 PK 1070 TM	98434544	AVX 13 x 1700 TM
4799021	AVX 13 x 1060 TM	504020489	4 PK 1075	98434545	AVX 13 x 1800
4799024	AVX 13 x 1060 TM	504022568	12 PK 1840 TM	98434545	AVX 13 x 1800 TM
4800089	AVX 13 x 1650	504027703	12 PK 1815 TM	98434546	AVX 13 x 1750
4800089	AVX 13 x 1650 TM	504027703	KT 7003	98434546	AVX 13 x 1750 TM
4809002	AVX 13 x 1550	504032641	4 PK 1025 TM	98434555	AVX 13 x 1350 TM
4809002	AVX 13 x 1550 TM	504032642	6 PK 1570	98434556	AVX 13 x 1275
4813541	AVX 13 x 1450	504032643	6 PK 1610	98434556	AVX 13 x 1275 TM
4813541	AVX 13 x 1450 TM	504046191	KT 7003	98434565	AVX 13 x 1375
4813561	AVX 13 x 1700	504049425	12 PK 1815 TM	98434565	AVX 13 x 1375 TM
4813561	AVX 13 x 1700 TM	504049425	KT 7003	98434569	AVX 13 x 1050
4814275	AVX 10 x 1025	504049426	12 PK 1840 TM	98434569	AVX 13 x 1050 TM
4815459	AVX 13 x 1425	504056043	10 PK 1715 TM	98434569	AVX 13 x 1150
4815459	AVX 13 x 1425 TM	504076915	ZRK 1596	98434569	AVX 13 x 1150 TM
4815464	AVX 13 x 1425	504092335	6 PK 1215	98435375	AVX 13 x 850
4815464	AVX 13 x 1425 TM	504183759	449ST	98435376	AVX 13 x 960
4816716	AVX 13 x 1200	61318427	AVX 13 x 1400 TM	98435377	AVX 13 x 1200
4816716	AVX 13 x 1200 TM	61672688	AVX 13 x 1425	98435377	AVX 13 x 1200 TM
4818791	AVX 13 x 1450	61672688	AVX 13 x 1425 TM	98435378	AVX 13 x 1100 TM
4818791	AVX 13 x 1450 TM	61689613	AVX 13 x 1475	98435379	AVX 13 x 1290
4829322	AVX 13 x 1800	61689613	AVX 13 x 1475 TM	98435379	AVX 13 x 1300
4829322	AVX 13 x 1800 TM	61689963	AVX 13 x 1425	98435379	AVX 13 x 1300 TM





Teilenummer Part number	Abmessung Dimension
----------------------------	------------------------

Teilenummer Part number	Abmessung Dimension
----------------------------	------------------------

Teilenummer Part number	Abmessung Dimension
----------------------------	------------------------

**IVECO**

98435429	AVX 13 x 1300
98435429	AVX 13 x 1300 TM
98435430	AVX 13 x 1350 TM
98436428	AVX 13 x 950
98436428	AVX 13 x 950 TM
98436429	AVX 13 x 1225 TM
98436429	AVX 13 x 1235
98437996	AVX 13 x 975
98437996	AVX 13 x 975 TM
98454854	AVX 13 x 1250
98454854	AVX 13 x 1250 TM
98455820	AVX 13 x 1235
98456206	AVX 13 x 1675
98456206	AVX 13 x 1675 TM
98459286	AVX 13 x 1060
98459286	AVX 13 x 1060 TM
98459452	AVX 13 x 1525
98459452	AVX 13 x 1525 TM
98459454	AVX 13 x 1050
98459454	AVX 13 x 1050 TM
98459455	AVX 13 x 1050
98459455	AVX 13 x 1050 TM
98461747	AVX 13 x 765
98462373	AVX 10 x 925
98463114	359UT
98463582	AVX 13 x 1000
98463584	AVX 13 x 1025
98463584	AVX 13 x 1025 TM
98464038	AVX 13 x 1285
98464044	AVX 13 x 1275
98464044	AVX 13 x 1275 TM
98464571	AVX 13 x 1425
98464571	AVX 13 x 1425 TM
98464573	AVX 13 x 1425
98464573	AVX 13 x 1425 TM
98464574	AVX 13 x 1425
98464574	AVX 13 x 1425 TM
98464713	AVX 13 x 1325
98464713	AVX 13 x 1325 TM
98465794	AVX 13 x 1025
98465794	AVX 13 x 1025 TM
98465812	AVX 13 x 950
98465812	AVX 13 x 950 TM
98465813	AVX 13 x 975
98465813	AVX 13 x 975 TM
98465820	AVX 13 x 1225
98465820	AVX 13 x 1225 TM
98465821	AVX 13 x 1275
98465821	AVX 13 x 1275 TM
98465830	AVX 13 x 1450
98465830	AVX 13 x 1450 TM
98465832	AVX 13 x 1060
98465832	AVX 13 x 1060 TM
98465834	AVX 13 x 1375
98465834	AVX 13 x 1375 TM
98465839	AVX 13 x 1400 TM
98465898	AVX 13 x 1025
98465898	AVX 13 x 1025 TM
98466077	AVX 13 x 1145
98466498	AVX 13 x 1150
98466498	AVX 13 x 1150 TM
98473728	AVX 13 x 1475
98473728	AVX 13 x 1475 TM
99432547	359UT
99449383	AVX 13 x 1350 TM

**IVECO**

99454341	AVX 10 x 935
99454342	AVX 13 x 800
99454342	AVX 13 x 800 TM
99456476	ZRK 1312
99456477	ZRK 1332
99459239	AVX 13 x 1325
99459239	AVX 13 x 1325 TM
99472776	4 PK 1025 TM
99472776	4 PK 1030
99481768	AVX 13 x 1375
99481768	AVX 13 x 1375 TM
99487233	15 PK 938 TM

**JAGUAR**

1S7Q6C301C	6 PK 1642
1X4E8620DB	6 PK 2465
5W9Q6C301A	6 PK 2055
C20887	AVX 13 x 750
C21109	AVX 13 x 825
C23138	AVX 10 x 913
C23344	AVX 13 x 1200
C27844	AVX 13 x 1125
C28955	AVX 13 x 775
C28956	AVX 13 x 1175
C28957	AVX 13 x 875
C29607	AVX 10 x 900
C29849	AVX 10 x 825
C2C37063	6 PK 2315
C2S24900	6 PK 2465
C2S27001	6 PK 1642
C32690	AVX 13 x 800
C36122	AVX 10 x 875
C36123	AVX 13 x 1525
C37139	AVX 10 x 888
C37891	AVX 13 x 1075
C37891CIGFB	AVX 13 x 1075
C41558	AVX 10 x 850
C41588	AVX 10 x 838
C43070	AVX 13 x 850
EAC1323	AVX 13 x 1075
EAC1616	AVX 10 x 850
EAC3850	AVX 10 x 1000
EAC3878	AVX 13 x 975
EAC7033	4 PK 995
EAC9369	4 PK 841
EBC11220	4 PK 1020
EBC11306	5 PK 975
EBC9394	5 PK 830
GFB220	AVX 13 x 1075
NAC2211BA	5 PK 830
NBD3700BA	5 PK 975

**JEEP**

04891661AA	6 PK 1718
05037542AA	6 PK 2075
4612277	6 PK 2465
4638133	6 PK 2404
46510601F	8 PK 2188
4796033	8 PK 2188
4841734AA	6 PK 1420
4854033	6 PK 2240
4854033AB	6 PK 2240
4891587AA	7 PK 2035
4891598AB	6 PK 2550
4891661AA	6 PK 1718

**JEEP**

4891692AB	6 PK 2040
4892791AA	6 PK 2205
5175961AA	7 PK 2035
5281315AC	6 PK 2330
5281351AC	6 PK 2330
530010314	6 PK 2415
53001119	6 PK 1990
53001120	6 PK 2080
53002899	6 PK 2605
53006870	6 PK 2475
53007539	6 PK 2460
53007595	6 PK 1800
53008722	6 PK 2191
53008744	7 PK 2283
53010010	6 PK 1760
53010027	6 PK 2500
53010150	6 PK 2330
53010234	6 PK 2270
53010254	6 PK 1975
53010257	6 PK 2000
53010269	6 PK 2475
53010275	6 PK 2465
53010276	6 PK 2460
53010279	6 PK 2500
53010283	6 PK 1760
53010284	6 PK 1800
53010285	6 PK 1800
53010288	6 PK 2191
53010289	7 PK 2283
53010311	6 PK 1980
53010314	6 PK 2415
53011012	6 PK 1900
53011035	6 PK 2315
53011097	7 PK 2271
53011097AB	7 PK 2271
53011098	7 PK 2276
53012002	6 PK 2415
53012009	6 PK 2255
53013209AC	6 PK 1910
53013298AA	6 PK 2255
53013352AC	6 PK 2145
53013600AA	6 PK 2605
53013676AB	6 PK 2080
53013905AA	6 PK 2191
53031118	6 PK 1800
53032037	6 PK 2215
53032037AC	6 PK 2225
53032037AF	6 PK 2225
53032037AI	6 PK 2225
53032037AJ	6 PK 2205
53054339	6 PK 2270
53054449	6 PK 2285
68001143AA	ZRK 1468
B4061025	6 PK 2605
Q4061025	6 PK 2605

**KÄSSBOHRER**

4765664100	AVX 10 x 900
47656641000	AVX 10 x 900
4765670100	AVX 10 x 1025
47656701000	AVX 10 x 1025
4765670102	AVX 10 x 1025
47656701020	AVX 10 x 1025
4765672100	AVX 10 x 1050
4765686100	AVX 10 x 1375



Teilenummer Part number	Abmessung Dimension
----------------------------	------------------------

Teilenummer Part number	Abmessung Dimension
----------------------------	------------------------

Teilenummer Part number	Abmessung Dimension
----------------------------	------------------------

**KÄSSBOHRER**

47658651000	AVX 10 x 935
4766702100	AVX 13 x 850
4766703100	AVX 13 x 875
4766703100	AVX 13 x 875 TM
4766704100	AVX 13 x 900
4766704100	AVX 13 x 900 TM
47667051000	AVX 13 x 925
47667051000	AVX 13 x 925 TM
4766708100	AVX 13 x 975
4766708100	AVX 13 x 975 TM
47667081000	AVX 13 x 975
47667081000	AVX 13 x 975 TM
4766709100	AVX 13 x 1000
4766709100	AVX 13 x 1000 TM
4766712100	AVX 13 x 1050
4766712100	AVX 13 x 1050 TM
47667151000	AVX 13 x 1100 TM
4766716100	AVX 13 x 1125
4766716100	AVX 13 x 1125 TM
4766716102	AVX 13 x 1125
4766716102	AVX 13 x 1125 TM
47667171000	AVX 13 x 1150
47667171000	AVX 13 x 1150 TM
4766717102	AVX 13 x 1150
4766717102	AVX 13 x 1150 TM
4766718100	AVX 13 x 1175
4766718100	AVX 13 x 1175 TM
4766718102	AVX 13 x 1175
4766718102	AVX 13 x 1175 TM
4766719100	AVX 13 x 1200
4766719100	AVX 13 x 1200 TM
4766719102	2/AVX 13 x 1200
4766719102	AVX 13 x 1200
4766719102	AVX 13 x 1200 TM
4766720100	AVX 13 x 1225
4766720100	AVX 13 x 1225 TM
4766721000	AVX 13 x 1250
4766721000	AVX 13 x 1250 TM
4766721100	AVX 13 x 1250
4766721100	AVX 13 x 1250 TM
4766721102	AVX 13 x 1250
4766721102	AVX 13 x 1250 TM
47667211020	AVX 13 x 1250
47667211020	AVX 13 x 1250 TM
4766721103	AVX 13 x 1250
4766721103	AVX 13 x 1250 TM
4766722000	AVX 13 x 1275
4766722000	AVX 13 x 1275 TM
4766722100	AVX 13 x 1275
4766722100	AVX 13 x 1275 TM
47667221000	AVX 13 x 1275
47667221000	AVX 13 x 1275 TM
4766722102	AVX 13 x 1275
4766722102	AVX 13 x 1275 TM
4766722103	AVX 13 x 1275
4766722103	AVX 13 x 1275 TM
4766723100	AVX 13 x 1300
4766723100	AVX 13 x 1300 TM
4766723102	AVX 13 x 1300
4766723102	AVX 13 x 1300 TM
4766724100	AVX 13 x 1325
4766724100	AVX 13 x 1325 TM
4766724102	AVX 13 x 1325
4766724102	AVX 13 x 1325 TM
4766725100	AVX 13 x 1350 TM

**KÄSSBOHRER**

4766725102	2/AVX 13 x 1350
4766725102	AVX 13 x 1350 TM
4766725103	AVX 13 x 1350 TM
4766726100	AVX 13 x 1375
4766726100	AVX 13 x 1375 TM
47667261000	AVX 13 x 1375
47667261000	AVX 13 x 1375 TM
4766726102	AVX 13 x 1375
4766726102	AVX 13 x 1375 TM
4766727100	AVX 13 x 1400 TM
4766727102	AVX 13 x 1400 TM
4766771100	AVX 13 x 1025
4766771100	AVX 13 x 1025 TM
4766773100	AVX 13 x 1500
4766773100	AVX 13 x 1500 TM
4766773102	2-AVX 13 x 1500 TM
47667731020	AVX 13 x 1500
47667731020	AVX 13 x 1500 TM
47667731030	AVX 13 x 1500
47667731030	AVX 13 x 1500 TM
4766774100	AVX 13 x 1525
47667741020	AVX 13 x 1525
4766775102	AVX 13 x 1550
4766775102	AVX 13 x 1550 TM
4766777102	2-AVX 13 x 1625 TM
4766778100	AVX 13 x 1650
4766778100	AVX 13 x 1650 TM
47667821000	AVX 13 x 1750
47667821000	AVX 13 x 1750 TM
47667831000	AVX 13 x 1800
47667831000	AVX 13 x 1800 TM
47667856003	AVX 13 x 1900
47667856003	AVX 13 x 1900 TM
47667861000	AVX 13 x 1900
47667861000	AVX 13 x 1900 TM
4766788002	AVX 13 x 1950
4766788002	AVX 13 x 1950 TM
4766788100	AVX 13 x 1950
4766788100	AVX 13 x 1950 TM
4766788102	AVX 13 x 1950
4766788102	AVX 13 x 1950 TM
47667951020	AVX 13 x 1550
47667951020	AVX 13 x 1550 TM
47667981000	AVX 13 x 1475
47667981000	AVX 13 x 1475 TM
4766799100	AVX 13 x 1575
4766799100	AVX 13 x 1575 TM
4766873000	AVX 13 x 1250
4766873000	AVX 13 x 1250 TM
47668811000	AVX 13 x 1775
47668811000	AVX 13 x 1775 TM
4766885100	AVX 13 x 1290
476698100	AVX 13 x 750
476698100	AVX 13 x 750 TM
4767701100	AVX 13 x 825
4767702100	AVX 13 x 850
4767704100	AVX 13 x 900
4767704100	AVX 13 x 900 TM
47677051000	AVX 13 x 925
47677051000	AVX 13 x 925 TM
47677141000	AVX 13 x 1075 TM
4767716102	AVX 13 x 1125
4767716102	AVX 13 x 1125 TM
4767718102	AVX 13 x 1175
4767718102	AVX 13 x 1175 TM

**KÄSSBOHRER**

4767720100	AVX 13 x 1225
4767720100	AVX 13 x 1225 TM
47677211020	AVX 13 x 1250
47677211020	AVX 13 x 1250 TM
4767722002	AVX 13 x 1275
4767722002	AVX 13 x 1275 TM
4767723100	AVX 13 x 1300
4767723100	AVX 13 x 1300 TM
4767724003	AVX 13 x 1325
4767724003	AVX 13 x 1325 TM
4767725100	AVX 13 x 1350 TM
4767772102	AVX 13 x 1450
4767772102	AVX 13 x 1450 TM
4767776100	AVX 13 x 1600
4767776100	AVX 13 x 1600 TM
4767776100	AVX 13 x 1625
4767776100	AVX 13 x 1625 TM
47677771020	AVX 13 x 1625
47677771020	AVX 13 x 1625 TM
4767784002	AVP 13 x 1825 TM
4767788002	AVP 13 x 1950 TM
4767795002	AVP 13 x 2450 TM
47680050040	XPB 1500
4768051000	AVX 13 x 1250
4768051000	AVX 13 x 1250 TM
4768052000	AVX 13 x 1200
4768052000	AVX 13 x 1200 TM
4768062000	AVX 13 x 1225
4768062000	AVX 13 x 1225 TM
5000182761	AVX 13 x 1950
5000182761	AVX 13 x 1950 TM
83120651560	AVX 10 x 1000

**KHD**

01180316HX	AVX 13 x 1025
01180316HX	AVX 13 x 1025 TM
1154353	AVX 13 x 1075 TM
1168300	AVX 10 x 950
1168303	AVX 10 x 1050
1168304	AVX 10 x 1075
1168304	AVX 10 x 1075 TM
1168305	AVX 10 x 1150
1168306	AVX 10 x 1175
1168314	AVX 13 x 1075 TM
1168330	AVX 13 x 1350 TM
1172463	AVX 10 x 1000
1172921	AVX 10 x 1025
1173266	AVX 10 x 975
1173539	AVX 10 x 1075
1173539	AVX 10 x 1075 TM
1174282	AVX 13 x 1650
1174282	AVX 13 x 1650 TM
1174283	AVX 13 x 1325
1174283	AVX 13 x 1325 TM
1175745	AVX 10 x 975
1175766	AVX 10 x 1525
1175928	AVX 10 x 1050
1176304	AVX 10 x 1375
1177190	AVX 13 x 1050
1177190	AVX 13 x 1050 TM
1179127	AVX 10 x 1175
1180173	AVX 10 x 1200
11880173	AVX 10 x 1200
2235178	AVX 10 x 1100
2235180	AVX 10 x 1150



Teilenummer Part number	Abmessung Dimension
----------------------------	------------------------

Teilenummer Part number	Abmessung Dimension
----------------------------	------------------------

Teilenummer Part number	Abmessung Dimension
----------------------------	------------------------

KHD	
-----	--

2235181	AVX 10 x 1175
2235253	AVX 10 x 1075
2235253	AVX 10 x 1075 TM
2235254	AVX 10 x 1350
2235254	AVX 10 x 1350 TM
2235257	AVX 10 x 1150
2235258	AVX 10 x 1175
2235263	AVX 10 x 1525
2235373	AVX 10 x 875
2235374	AVX 10 x 900
2235376	AVX 10 x 875
2235377	AVX 10 x 900
2235530	AVX 10 x 1275
2235531	AVX 10 x 1275
2235532	AVX 10 x 1340
2235533	AVX 10 x 1340
2235713	AVX 10 x 950
2235714	AVX 10 x 1325
2235816	AVX 10 x 1325
2237477	AVX 10 x 975
2421916	AVX 13 x 1125
2421916	AVX 13 x 1125 TM
4325382	AVX 13 x 900
4325382	AVX 13 x 900 TM
4342249	AVX 13 x 1450
4342249	AVX 13 x 1450 TM

KIA	
-----	--

0075018381C	AVX 13 x 1125
0075018381C	AVX 13 x 1125 TM
0K01118381A	4 PK 920
0K01232611	AVX 13 x 775
0K05412205	ZRK 1225
0K20312205	ZRK 1281
0K20A15908	4 PK 900
0K20B15909	4 PK 1015
0K21A18381	4 PK 884
0K24415909A	4 PK 1050
0K2A315909	4 PK 1080
0K2AA15907	4 PK 925
0K2AA15908	4 PK 962
0K2AA32907	4 PK 920
0K2CP15909	4 PK 1060
0K2FT15908	4 PK 845
0K2JV15909	4 PK 1020
0K30C15909C	4 PK 970
0K30E12205	ZRK 1442
0K41018381A	AVX 13 x 1450
0K55112205B	ZRK 1402
0K55215909	4 PK 870
0K55315987	5 PK 1590
0K65B15907C	AVX 13 x 900
0K71W18381	4 PK 940
0K88R12205	ZRK 1403
0K88R12205B	ZRK 1403
0K93312730	952UT
0K93712700A	951ST
0K93712730	952UT
0K93812700	951ST
0K93812730	952UT
0K94115908	4 PK 1050
0K95412730	956UT
0K95418381	3 PK 763
0K95512730	956UT
0K95512730A	956UT

KIA	
-----	--

0K95K15909	6 PK 1580
0K96815909	5 PK 1070
0K97212700	953ST
0K97212700A	953ST
0K97212730	954UT
0K97312700	953ST
0K97312700A	953ST
0K97312730	954UT
0K9A015909	4 PK 1110
0K9A115909	4 PK 1110
0K9A315909	5 PK 1070
0K9A615987	6 PK 2013
0K9AA15907	4 PK 940
0K9AC15907	5 PK 950
0W06532611	AVX 13 x 875
0W06532611	AVX 13 x 875 TM
2335633160	ZRK 1459
2335638010	ZRK 1578
2335638011	ZRK 1578
2335638020	ZRK 1578
243120Z000	ZRK 1155
2431223202	ZRK 1170
2431227000	ZRK 1454
243122X000	ZRK 1442
2431237100	ZRK 1704
2431237400	ZRK 1704
2431237500	ZRK 1704
2431238010	ZRK 1073
2431238020	ZRK 1073
2431238220	ZRK 1429
244102X000	950UT
244102X700	951ST
244102X701	951ST
2481023050	184UT
2481023500	184UT
248102X700	952UT
2521202550	4 PK 780
2521223000	4 PK 875
2521223700	4 PK 890
2521224350	4 PK 870
2521225000	6 PK 2585
2521225020	6 PK 2510
2521226000	4 PK 850
2521227002	6 PK 1515
2521227010	6 PK 1515
2521227160	6 PK 1400
2521227350	6 PK 1515
2521227351	6 PK 1515
2521227360	6 PK 1515
252122A000	5 PK 1790
252122A001	5 PK 1790
252122A112	5 PK 1850
252122A120	5 PK 1800
252122A121	5 PK 1800
252122B000	6 PK 2140
252122B010	6 PK 1530
252122B020	6 PK 1255
252122B030	6 PK 955
2521233160	4 PK 995
2521237162	6 PK 1695
2521237181	6 PK 2000
2521239800	5 PK 1130
252123C100	6 PK 2475
252123C200	6 PK 2475
252123E000	6 PK 2055

KIA	
-----	--

252123E050	6 PK 2055
252124A000	7 PK 2283
252124A010	7 PK 1730
252124A100	7 PK 2271
252124A400	7 PK 2255
57161H1300	4 PK 1080
5717002710	4 PK 750
571702D101	3 PK 675
5717038010	5 PK 1390
5717039000	5 PK 905
571814A000	4 PK 1060
9771302000	4 PK 675
9771311200	4 PK 813
977131C200	4 PK 813
9771326300	6 PK 1195
977132D100	4 PK 855
977132D510	4 PK 855
AA33115909	AVX 13 x 900
AA33115909	AVX 13 x 900 TM
B30115909	4 PK 950
B3C715907C	4 PK 850
B3C715909C	4 PK 966
B3C718381B	4 PK 875
KF20212205	ZRK 1168
KK14015909	4 PK 925
KK15012700A	950UT
KK15012700B	950UT
KK15112700	950UT
KK35012205	ZRK 1071
KK37115909	4 PK 900
MB36615907	4 PK 890
MB36615907A	4 PK 890
MB37615907	4 PK 805
MB3C718381B	4 PK 875
MB63012700D	950UT
MB63012700E	950UT
MBP0112205B	ZRK 1071
OK01612205	ZRK 1264
OK20112205	ZRK 1071
OK55112205B	ZRK 1402
OK88R12205	ZRK 1403
OK88R12205B	ZRK 1403

LADA	
------	--

111801041020	6 PK 1015
21011308020	AVX 10 x 935
21011308020	AVX 10 x 938
21011308020	AVX 10 x 940
21011308026	AVX 10 x 935
21011308026	AVX 10 x 938
21051006040	ZRK 1213
21051006118	751ST
21051006124	751ST
21071308020	AVX 10 x 938
21081006040	ZRK 1123
210810060400	ZRK 1123
210810060401	ZRK 1123
21081006120	441ST
210823701720	6 PK 698
21083701720	AVX 10 x 710
21101041020	6 PK 1115
21103701720	6 PK 745
21108114096	6 PK 1125
211081140961	5 PK 1125
21121006040	ZRK 1538





Teilenummer Part number	Abmessung Dimension	Teilenummer Part number	Abmessung Dimension	Teilenummer Part number	Abmessung Dimension
<b>LADA</b>		<b>LANCIA</b>		<b>LANCIA</b>	
211210060400	ZRK 1029	46537099	4 PK 962	60625927	7 PK 1950
21126-100604	ZRK 1593	46540146	6 PK 1695	60626658	6 PK 1990
212151006040	ZRK 1262	46540546	6 PK 1038	60630741	6 PK 1975
212151006120	284ST	46542138	5 PK 940	60653030	6 PK 1965
212151006138	262UT	46542302	4 PK 962	60666949	6 PK 1045
21231041020	5 PK 1815	46548288	ZRK 1422	60666950	6 PK 1840
212310410200	5 PK 1515	46550322	5 PK 1590	60674890	ZRK 1249
212310410203	5 PK 1885	46736814	4 PK 665	60676136	6 PK 1060
212310410203	5 PK 1885	46738444	5 PK 940	60807260	ZRK 1286
3701720	AVX 10 x 710	46738445	3 PK 668	60808954	7 PK 1175
9128736	509UT	46749665	6 PK 1840	60809160	5 PK 940
91541178	4 PK 1230	46751187	ZRK 1322	60810651	7 PK 1970
96142597	ZRK 1262	46751200	4 PK 675	60812001	7 PK 1970
<b>LANCIA</b>		46759720	6 PK 1840	60812329	7 PK 1080
2115483	AVX 13 x 1500	46775098	6 PK 1138	60812350	7 PK 1950
2115483	AVX 13 x 1500 TM	46787905	3 PK 913	60813206	6 PK 1990
2156019	AVX 10 x 965	46787907	6 PK 1760	60813756	6 PK 1045
2173817	AVX 13 x 900	46791187	ZRK 1747	60814576	6 PK 1975
2173817	AVX 13 x 900 TM	46791189	ZRK 1451	60814603	ZRK 1113
2173818	AVX 13 x 1450	46809420	4 PK 665	60815412	6 PK 1078
4152329	ZRK 1087	46820062	6 PK 1185	60815414	6 PK 1975
4158457	AVX 10 x 850	46820063	6 PK 1310	60816660	6 PK 1740
4176840	ZRK 1051	46820063A	6 PK 1310	62308185	AVX 10 x 1013
4182425	ZRK 1087	4829182	AVX 13 x 925	7031864	AVX 10 x 1125
4201439	ZRK 1089	4833708	AVX 13 x 925	7031865	ZRK 1058
4201738	ZRK 1089	4833709	AVX 10 x 635	71718718	4 PK 675
4201739	ZRK 1089	4834370	ZRK 1094	71718838	4 PK 841
4242396	ZRK 1267	4834880	AVX 13 x 825	71719039	4 PK 698
4250074	ZRK 1052	4852376	ZRK 1239	71719398	3 PK 913
4313390	AVX 10 x 825	500323627	ZRK 1316	71719559	5 PK 1570
4324568	ZRK 1053	55183528	ZRK 1466	71719642	4 PK 1100
4371913	AVX 10 x 1000	55187103	ZRK 1451	71719643	ZRK 1422
4401261	ZRK 1267	55191006	6 PK 1195	71719738	4 PK 665
4420507	ZRK 1051	55191970	5 PK 1145	71719745	5 PK 905
4448400	AVX 10 x 838	55192799	5 PK 940	71731639	ZRK 1113
4452647	ZRK 1052	55192802	3 PK 668	71734716	6 PK 1740
4458068	AVX 10 x 864	55193795	5 PK 1145	71736717	KT 1253
46129991	3 PK 855	55202377	6 PK 1185	71736726	KT 1404
46130771	4 PK 1245	55203786	ZRK 1438	71739905	5 PK 940
46136505	3 PK 855	5882989	AVX 10 x 925	71745115	6 PK 1185
46400045	ZRK 1245	5948450	AVX 10 x 1050	71749419	4 PK 1100
46400047	3 PK 668	5948451	AVX 10 x 1050	71749433	5 PK 905
46403659	ZRK 1322	5953873	AVX 10 x 938	71749437	5 PK 1104
46403854	5 PK 940	5953873	AVX 10 x 940	71749474	ZRK 1027
46411594	3 PK 668	5956106	ZRK 1084	7302675	ZRK 1094
46414859	6 PK 1070	5956125	ZRK 1309	7302791	AVX 10 x 635
46414860	6 PK 1718	5956599	AVX 10 x 825	7302819	AVX 10 x 715
46426983	ZRK 1113	5973343	ZRK 1053	7303004	AVX 10 x 925
46429443	4 PK 675	5973727	ZRK 1058	7303315	AVX 10 x 775
46439000	6 PK 1105	5978842	AVX 10 x 913	7303414	ZRK 1100
46444537	6 PK 1740	5980075	AVX 10 x 740	7303462	AVX 10 x 813
46448693	5 PK 940	5992144	5 PK 870	73500782	5 PK 1570
46451652	4 PK 855	60565258	4 PK 790	7533397	AVX 10 x 775
46456894	4 PK 962	60568842	7 PK 1240	7540063	AVX 10 x 813
46457061	ZRK 1027	60573075	7 PK 1175	7541662	AVX 10 x 913
46457742	ZRK 1422	60575209	4 PK 763	7547752	5 PK 1345
46462943	3 PK 668	60603101	6 PK 1990	7552281	AVX 10 x 1090
46462944	5 PK 940	60605423	7 PK 1970	7552380	AVX 10 x 775
46474062	6 PK 1840	60617858	7 PK 1080	7553224	5 PK 850
46479557	6 PK 1760	60617859	7 PK 1950	7553226	5 PK 850
46514138	6 DPK 1225	60617860	6 PK 1045	7553716	AVX 10 x 690
46515401	ZRK 1027	60617862	6 PK 1840	7554502	AVX 10 x 750
46517850	4 PK 841	60618584	7 PK 1970	7554605	AVX 10 x 1125
46517851	4 PK 698	60620887	ZRK 1420	7554701	ZRK 1111
		60625130	ZRK 1249	7565945	6 PK 1610



Teilenummer Part number	Abmessung Dimension
----------------------------	------------------------

Teilenummer Part number	Abmessung Dimension
----------------------------	------------------------

Teilenummer Part number	Abmessung Dimension
----------------------------	------------------------

**LANCIA**

7574198	AVX 10 x 838
7575315	AVX 10 x 1000
7576113	AVX 10 x 1125
7576114	AVX 10 x 1090
7576135	ZRK 1244
7581316	AVX 10 x 825
7581317	AVX 10 x 825
7589248	AVX 13 x 825
7596379	ZRK 1111
7596722	ZRK 1253
7597169	7 PK 1220
7597531	AVX 10 x 813
7604702	AVX 10 x 825
7609091	AVX 10 x 913
7609093	AVX 10 x 888
7610944	AVX 10 x 675
7614957	AVX 10 x 735
7614999	ZRK 1286
7615058	5 PK 985
7617214	AVX 13 x 1025
7617278	AVX 13 x 850
7618521	AVX 10 x 838
7619418	AVX 10 x 675
7621256	AVX 13 x 875
7627908	AVX 13 x 850
7629031	5 PK 905
7629229	5 PK 920
7629235	AVX 13 x 750
7629316	AVX 13 x 800
7629650	7 PK 1675
7631375	5 PK 925
7632090	5 PK 962
7633335	AVX 10 x 735
7633936	4 PK 1100
7635566	4 PK 1100
7636057	4 PK 1050
7636058	4 PK 1050
7636059	4 PK 1060
7636060	4 PK 1060
7636448	3 PK 675
7636895	3 PK 913
7636896	3 PK 913
7638225	AVX 10 x 735
7640256	5 PK 905
7640257	5 PK 985
7640258	5 PK 925
7644467	5 PK 962
7646849	5 PK 1055
7649219	AVX 13 x 850
7651197	4 PK 913
7651549	AVX 13 x 750
7653808	7 PK 1715
7655543	AVX 13 x 850
7655544	AVX 13 x 750
7659062	ZRK 1252
7695546	ZRK 1247
7695968	5 PK 1040
7701471773	KT 1217
7702169	5 PK 1055
7702740	5 PK 1040
7704978	4 PK 675
7706132	5 PK 970
7710579	ZRK 1249
7718418	5 PK 1104
7723828	AVX 10 x 690

**LANCIA**

7732676	ZRK 1246
7743081	ZRK 1244
7745354	4 PK 705
7749145	5 PK 940
7750728	3 PK 685
7750729	4 PK 813
7758972	4 PK 962
7761147	5 PK 940
7764914	ZRK 1747
7765715	5 PK 925
7765716	AVX 10 x 864
7765717	5 PK 962
7766106	6 PK 1138
7766684	6 PK 1038
7773139	5 PK 1080
7774591	ZRK 1252
7776570	AVX 10 x 650
7788011	6 PK 1695
7788553	4 PK 825
7788554	3 PK 685
7799581	4 PK 855
80404106	AVX 10 x 825
82068038	AVX 10 x 1100
82288389	AVX 10 x 1000
82310543	AVX 10 x 1175
82329974	AVX 10 x 1100
82332275	AVX 10 x 700
82336411	AVX 10 x 1225
82341655	AVX 13 x 1825
82342730	AVX 10 x 1140
82398036	AVX 10 x 775
82401268	AVX 13 x 1400
82401269	AVX 13 x 1225
9400816549	ZRK 1144
9400831069	KT 1068
9400831279	KT 1040
9400831489	KT 1216
9400831529	KT 1070
9400831609	KT 1350
9400831929	KT 1428
9463380180	ZRK 1445
9464640380	ZRK 1452
96152078	6 PK 1660
96152082	6 PK 1070
96152084	6 PK 1078
96188881	6 PK 1740
96205509	6 PK 1605
9620550980	6 PK 1605
96236847	6 PK 1165
96242338	6 PK 1105
9624233880	6 PK 1105
9629054080	6 PK 1740
9630796180	6 PK 1751
9631333880	6 PK 1740
96324103	6 PK 1740
9632410380	6 PK 1740
9632959380	ZRK 1703
9633478180	6 PK 1470
9634765180	6 PK 1710
9638027080	6 PK 1580
9638234780	6 PK 1470
9641069580	6 PK 1190
9641705880	6 PK 1710
9644846680	6 PK 1740
9655945780	6 PK 1215

**LANCIA**

9658643680	6 PK 1205
9662187580	ZRK 1575
98415921	ZRK 1316
98419390	ZRK 1312
98455448	5 PK 886

**LAND ROVER**

11282245850	4 PK 841
1316644	6 PK 2080
6G9N8620BB	6 PK 1205
AHU2716	3 PK 750
CDU2160	3 PK 750
ERR0914	5 PK 1140
ERR2215	4 PK 1325
ERR2678	4 PK 1260
ERR3287	7 PK 1605
ERR4461	7 PK 1870
ERR4623	7 PK 2255
ERR5911	7 PK 1580
ERR6896	7 PK 2710 TM
ERR6899	7 PK 1775
ERR914	5 PK 1140
ETC9101	4 PK 841
GFB101750	6 PK 1751
GMB30735	3 PK 750
GMB30755	3 PK 750
GMB50735	5 PK 735
GMB51190	5 PK 1190
GMB61185	6 PK 1185
GMB61465	6 PK 1460
GTB1497XS	ZRK 1749
GTB9000	ZRK 1350
LHN100410	ZRK 1350
LHN100560	ZRK 1749
LHP100550L	338ST
LR000660	448UT
LR000996	6 PK 1748
LR003570	6 PK 1205
LR004257	ZRK 1575
PQR500240	7 PK 2276
PQR500320	7 PK 2276
PQS000100	7 PK 1630
PQS000180	5 PK 886
PQS000190	5 PK 812
PQS000200	5 PK 2020
PQS000220	5 PK 1005
PQS10061	6 PK 1751
PQS100840	5 PK 735
PQS100850	6 PK 1460
PQS100851	6 PK 1460
PQS100900	6 PK 1370
PQS101030	6 PK 1185
PQS101130	5 PK 1190
PQS101180	5 PK 1200
PQS101261	6 PK 1285
PQS101261L	6 PK 1285
PQS101262L	6 PK 1285
PQS101271	6 PK 1560
PQS101271L	6 PK 1560
PQS101272L	6 PK 1560
PQS101300	5 PK 2030
PQS101300L	5 PK 2030
PQS101310	5 PK 870
PQS101310L	5 PK 870
PQS101480	7 PK 2315



Teilenummer Part number	Abmessung Dimension
----------------------------	------------------------

**LAND ROVER**

PQS101490	7 PK 1715
PQS101630	7 PK 2337
PQS500081	6 PK 2080
STC2134	5 PK 1815
STC2326	4 PK 855
STC3397	4 PK 841
STC4455	5 PK 1815

**LDV**

46510641F	6 PK 1910
523000002	6 PK 1910

**LEXUS**

1356829015	ZRK 1323
9008021040	6 PK 1038
9008091088	4 PK 875
9008091147	6 PK 1038
9008091212	4 PK 875
9008091239	6 PK 1038
9091602177	3 PK 763
9091602231	6 PK 2245
9091602309	6 PK 1940
9091602310	6 PK 1940
9091602352	4 PK 805
9091602360	6 PK 2245
9091602371	6 PK 1940
9091602373	6 PK 1055
9091602386	4 PK 875
9091602401	6 PK 1035
9091602404	6 PK 2228
9091602405	6 PK 2228
9091602412	6 PK 1930
9091602437	6 PK 2200
9091602462	6 PK 2260
9091602463	6 PK 2245
9091602471	4 PK 1075
9091602583	6 PK 2260
9091602584	6 PK 2260
9091602585	6 PK 2240
9091602586	6 PK 2245
9091602592	6 PK 2120
9091602632	6 PK 2055
9091602637	6 PK 2100
9091602658	6 PK 2100
9091602661	4 PK 913
9936300890	3 PK 890
9936421070	4 PK 1075
9936430900	4 PK 900
9936480880	4 PK 875
99364C1050	4 PK 1050
9936671050	6 PK 1055
99366C2200	6 PK 2200
99366C2230	6 PK 2228
99366D2230	6 PK 2228
99366H2230	6 PK 2228

**LEYLAND**

13H1329	AVX 10 x 864
13H1448	AVX 13 x 1125
13H1448	AVX 13 x 1125 TM
13H1733	AVX 13 x 1075 TM
13H1756	AVX 13 x 1300
13H1756	AVX 13 x 1300 TM
13H1840	AVX 13 x 1075 TM
13H199	AVX 13 x 1125

Teilenummer Part number	Abmessung Dimension
----------------------------	------------------------

**LEYLAND**

13H199	AVX 13 x 1125 TM
13H2096	AVX 13 x 1525
13H2126	AVX 13 x 1525
13H2173	AVX 13 x 1300
13H2173	AVX 13 x 1300 TM
13H2659	AVX 13 x 1100 TM
13H3065	AVX 13 x 900
13H3065	AVX 13 x 900 TM
13H3348	AVX 13 x 1025
13H3348	AVX 13 x 1025 TM
13H3708	AVX 13 x 875
13H3708	AVX 13 x 875 TM
13H3726	AVX 10 x 1050
13H3820	AVX 10 x 888
13H4366	AVX 10 x 888
13H4583	AVX 10 x 888
13H4646	AVX 13 x 975
13H4646	AVX 13 x 975 TM
13H4706	AVX 10 x 850
13H480	AVX 13 x 1150
13H480	AVX 13 x 1150 TM
13H503	AVX 10 x 925
13H5373	AVX 10 x 825
13H566	AVX 13 x 950
13H566	AVX 13 x 950 TM
13H589	AVX 10 x 813
13H6869	AVX 10 x 1050
13H7104	AVX 10 x 1175
13H7105	AVX 10 x 1140
13H760	AVX 10 x 1110
13H7975	AVX 10 x 1050
13H8309	AVX 10 x 888
13H8310	AVX 10 x 900
13H8339	AVX 10 x 825
13H8389	AVX 10 x 813
13H848	AVX 13 x 1100 TM
13H859	AVX 10 x 813
13H8673	AVX 10 x 838
13H923	AVX 10 x 900
13H9393	AVX 10 x 1225
13H9620	AVX 10 x 950
602473	AVX 13 x 818
611023	AVX 10 x 1225
ADU6528	AVX 10 x 940
AHU2177	AVX 10 x 785
C20887	AVX 13 x 750
C20887	AVX 13 x 750 TM
C28957	AVX 13 x 875
C28957	AVX 13 x 875 TM
C29607	AVX 10 x 900
EAC3850	AVX 10 x 1000
GFB101	AVX 10 x 925
GFB102	AVX 10 x 813
GFB138	AVX 10 x 838
GFB182	AVX 10 x 888
GFB193	AVX 10 x 813

**LOTUS**

A907E0191Z	ZRK 1370
------------	----------

**MACK**

88GB447P728	10 PK 1860 TM
-------------	---------------

**MAN**

06560792332	AVX 13 x 1300
-------------	---------------

Teilenummer Part number	Abmessung Dimension
----------------------------	------------------------

**MAN**

06560792332	AVX 13 x 1300 TM
06580100539	AVX 13 x 950
06580100539	AVX 13 x 950 TM
06580100540	AVX 13 x 1000
06580100540	AVX 13 x 1000 TM
06580410238	AVX 13 x 1425
06580410238	AVX 13 x 1425 TM
06580420225	AVX 13 x 1100 TM
06580420238	AVX 13 x 1425
06580420238	AVX 13 x 1425 TM
06580420242	AVX 13 x 1525
06580420242	AVX 13 x 1525 TM
06580422240	AVX 13 x 1475
06580422240	AVX 13 x 1475 TM
06580430121	AVX 10 x 1000
06580430126	AVX 10 x 1125
06580430133	AVX 13 x 1300
06580430133	AVX 13 x 1300 TM
06580430221	AVX 13 x 1000
06580430221	AVX 13 x 1000 TM
06580430226	AVX 13 x 1125
06580430226	AVX 13 x 1125 TM
06580430234	AVX 13 x 1325
06580430234	AVX 13 x 1325 TM
06580430237	AVX 13 x 1400 TM
06580430240	AVX 13 x 1575
06580430240	AVX 13 x 1575 TM
06580430241	AVX 13 x 1500
06580430241	AVX 13 x 1500 TM
06580430242	AVX 13 x 1525
06580430242	AVX 13 x 1525 TM
06580430243	AVX 13 x 1550
06580430243	AVX 13 x 1550 TM
06580430255	AVX 13 x 1100 TM
06580430283	AVX 13 x 1425
06580430283	AVX 13 x 1425 TM
06580432224	AVX 13 x 1075 TM
06580432230	AVX 13 x 1225
06580432230	AVX 13 x 1225 TM
06580432232	AVX 13 x 1275
06580432232	AVX 13 x 1275 TM
06580432233	AVX 13 x 1300
06580432233	AVX 13 x 1300 TM
06580432238	AVX 13 x 1425
06580432238	AVX 13 x 1425 TM
06580432239	AVX 13 x 1450
06580432239	AVX 13 x 1450 TM
06580432242	AVX 13 x 1525
06580432243	AVX 13 x 1550
06580432243	AVX 13 x 1550 TM
06580432245	AVX 13 x 1600
06580432245	AVX 13 x 1600 TM
06580432246	AVX 13 x 1625
06580432246	AVX 13 x 1625 TM
06580432247	AVX 13 x 1650
06580432247	AVX 13 x 1650 TM
06580450241	AVX 13 x 1500
06580450241	AVX 13 x 1500 TM
06580452230	AVX 13 x 1225
06580452230	AVX 13 x 1225 TM
06580470133	AVX 10 x 1300
06580470227	AVX 13 x 1150
06580470227	AVX 13 x 1150 TM
06580470230	AVX 13 x 1225
06580470230	AVX 13 x 1225 TM



Teilenummer Part number	Abmessung Dimension
----------------------------	------------------------

Teilenummer Part number	Abmessung Dimension
----------------------------	------------------------

Teilenummer Part number	Abmessung Dimension
----------------------------	------------------------

**MAN****MAN****MAN**

06580472221	AVX 13 x 1100 TM
06580472224	AVX 13 x 1075 TM
06580472225	AVX 13 x 1100 TM
06580472226	AVX 13 x 1125
06580472226	AVX 13 x 1125 TM
06580472230	AVX 13 x 1225
06580472230	AVX 13 x 1225 TM
06580472234	AVX 13 x 1325
06580472234	AVX 13 x 1325 TM
06580472238	AVX 13 x 1425
06580472238	AVX 13 x 1425 TM
06580472241	AVX 13 x 1500
06580472241	AVX 13 x 1500 TM
06580472242	AVX 13 x 1525
06580472242	AVX 13 x 1525 TM
06580472243	AVX 13 x 1550
06580472243	AVX 13 x 1550 TM
06580472244	AVX 13 x 1575
06580472244	AVX 13 x 1575 TM
06580472245	AVX 13 x 1600
06580472245	AVX 13 x 1600 TM
06580480231	AVX 13 x 1250
06580480231	AVX 13 x 1250 TM
06580482231	AVX 13 x 1250
06580482231	AVX 13 x 1250 TM
06580490010	AVX 13 x 800
06580490010	AVX 13 x 800 TM
06580490026	6 PK 1515 TM
06580490038	8 PK 1495 TM
06580490044	8 PK 1495 TM
06580590206	XPB 1500
06580720231	AVX 13 x 1250
06580720231	AVX 13 x 1250 TM
06580721111	AVX 10 x 750
06580721181	AVX 10 x 925
06580721201	AVX 10 x 975
06580721211	AVX 10 x 1000
06580721261	AVX 10 x 1125
06580721312	AVX 10 x 1250
06580721321	AVX 10 x 1275
06580721361	AVX 10 x 1425
06580721372	AVX 10 x 1400
06580721422	AVX 10 x 1525
06580721542	10 x 1822
06580722112	AVX 13 x 750
06580722112	AVX 13 x 750 TM
06580722133	AVX 13 x 800
06580722133	AVX 13 x 800 TM
06580722141	AVX 13 x 825
06580722192	AVX 13 x 950
06580722192	AVX 13 x 950 TM
06580722201	AVX 13 x 975
06580722201	AVX 13 x 975 TM
06580722212	AVX 13 x 1000
06580722212	AVX 13 x 1000 TM
06580722222	AVX 13 x 1025
06580722222	AVX 13 x 1025 TM
06580722231	AVX 13 x 1050
06580722231	AVX 13 x 1050 TM
06580722242	AVX 13 x 1075 TM
06580722252	AVX 13 x 1100 TM
06580722262	AVX 13 x 1125
06580722262	AVX 13 x 1125 TM
06580722292	AVX 13 x 1200
06580722292	AVX 13 x 1200 TM

06580722293	AVX 13 x 1200
06580722293	AVX 13 x 1200 TM
06580722301	AVX 13 x 1225
06580722301	AVX 13 x 1225 TM
06580722302	AVX 13 x 1225
06580722302	AVX 13 x 1225 TM
06580722311	AVX 13 x 1250
06580722311	AVX 13 x 1250 TM
06580722312	AVX 13 x 1250
06580722312	AVX 13 x 1250 TM
06580722321	AVX 13 x 1275
06580722321	AVX 13 x 1275 TM
06580722322	AVX 13 x 1275
06580722322	AVX 13 x 1275 TM
06580722323	AVX 13 x 1275
06580722323	AVX 13 x 1275 TM
06580722331	AVX 13 x 1300
06580722331	AVX 13 x 1300 TM
06580722332	AVX 13 x 1300
06580722332	AVX 13 x 1300 TM
06580722342	AVX 13 x 1325
06580722342	AVX 13 x 1325 TM
06580722344	AVX 13 x 1325
06580722344	AVX 13 x 1325 TM
06580722352	2/AVX 13 x 1350
06580722382	AVX 13 x 1425
06580722382	AVX 13 x 1425 TM
06580722391	AVX 13 x 1450
06580722391	AVX 13 x 1450 TM
06580722392	AVX 13 x 1450
06580722392	AVX 13 x 1450 TM
06580722401	AVX 13 x 1475
06580722401	AVX 13 x 1475 TM
06580722402	AVX 13 x 1475
06580722402	AVX 13 x 1475 TM
06580722412	AVX 13 x 1500
06580722412	AVX 13 x 1500 TM
06580722422	AVX 13 x 1525
06580722422	AVX 13 x 1525 TM
06580722431	AVX 13 x 1550
06580722431	AVX 13 x 1550 TM
06580722432	AVX 13 x 1550
06580722432	AVX 13 x 1550 TM
06580722433	AVX 13 x 1550
06580722433	AVX 13 x 1550 TM
06580722442	AVX 13 x 1575
06580722442	AVX 13 x 1575 TM
06580722452	AVX 13 x 1600
06580722452	AVX 13 x 1600 TM
06580722501	AVX 13 x 1725
06580722511	AVX 13 x 1750
06580722511	AVX 13 x 1750 TM
06580722542	AVX 13 x 1825
06580722542	AVX 13 x 1825 TM
06580731212	AVX 10 x 1000
06580731241	AVX 10 x 1075
06580731241	AVX 10 x 1075 TM
06580731252	AVX 10 x 1100
06580731321	AVX 10 x 1275
06580731351	AVX 10 x 1350
06580731351	AVX 10 x 1350 TM
06580731361	AVX 10 x 1375
06580731381	AVX 10 x 1425
06580732133	AVX 13 x 800
06580732133	AVX 13 x 800 TM

06580732142	AVX 13 x 825
06580732143	AVX 13 x 825
06580732151	AVX 13 x 850
06580732162	AVX 13 x 875
06580732162	AVX 13 x 875 TM
06580732172	AVX 13 x 900
06580732172	AVX 13 x 900 TM
06580732182	AVX 13 x 925
06580732182	AVX 13 x 925 TM
06580732192	AVX 13 x 950
06580732192	AVX 13 x 950 TM
06580732202	AVX 13 x 975
06580732202	AVX 13 x 975 TM
06580732212	AVX 13 x 1000
06580732212	AVX 13 x 1000 TM
06580732222	AVX 13 x 1025
06580732222	AVX 13 x 1025 TM
06580732232	2/AVX 13 x 1050
06580732232	AVX 13 x 1050
06580732232	AVX 13 x 1050 TM
06580732242	AVX 13 x 1075 TM
06580732252	AVX 13 x 1100 TM
06580732262	AVX 13 x 1125
06580732262	AVX 13 x 1125 TM
06580732272	AVX 13 x 1150
06580732272	AVX 13 x 1150 TM
06580732282	AVX 13 x 1175
06580732282	AVX 13 x 1175 TM
06580732283	AVX 13 x 1425
06580732283	AVX 13 x 1425 TM
06580732292	2/AVX 13 x 1200
06580732292	AVX 13 x 1200
06580732292	AVX 13 x 1200 TM
06580732301	AVX 13 x 1225
06580732301	AVX 13 x 1225 TM
06580732302	AVX 13 x 1225
06580732302	AVX 13 x 1225 TM
06580732311	AVX 13 x 1250
06580732311	AVX 13 x 1250 TM
06580732312	AVX 13 x 1250
06580732312	AVX 13 x 1250 TM
06580732321	AVX 13 x 1275
06580732321	AVX 13 x 1275 TM
06580732323	3/AVX 13 x 1275
06580732323	AVX 13 x 1275
06580732323	AVX 13 x 1275 TM
06580732332	AVX 13 x 1300
06580732332	AVX 13 x 1300 TM
06580732334	AVX 13 x 1300
06580732334	AVX 13 x 1300 TM
06580732342	AVX 13 x 1325
06580732342	AVX 13 x 1325 TM
06580732343	AVX 13 x 1325
06580732343	AVX 13 x 1325 TM
06580732351	AVX 13 x 1350 TM
06580732352	2/AVX 13 x 1350
06580732352	AVX 13 x 1350 TM
06580732362	AVX 13 x 1375
06580732362	AVX 13 x 1375 TM
06580732371	AVX 13 x 1400 TM
06580732372	AVX 13 x 1400 TM
06580732374	AVX 13 x 1400 TM
06580732382	AVX 13 x 1425
06580732382	AVX 13 x 1425 TM
06580732383	AVX 13 x 1425



Teilenummer Part number	Abmessung Dimension
----------------------------	------------------------

Teilenummer Part number	Abmessung Dimension
----------------------------	------------------------

Teilenummer Part number	Abmessung Dimension
----------------------------	------------------------

**MAN**

06580732383	AVX 13 x 1425 TM
06580732391	AVX 13 x 1450
06580732391	AVX 13 x 1450 TM
06580732392	AVX 13 x 1450
06580732392	AVX 13 x 1450 TM
06580732394	AVX 13 x 1450
06580732394	AVX 13 x 1450 TM
06580732402	AVX 13 x 1475
06580732402	AVX 13 x 1475 TM
06580732403	AVX 13 x 1475
06580732403	AVX 13 x 1475 TM
06580732412	AVX 13 x 1500
06580732412	AVX 13 x 1500 TM
06580732413	AVX 13 x 1500
06580732413	AVX 13 x 1500 TM
06580732414	AVX 13 x 1500
06580732414	AVX 13 x 1500 TM
06580732422	AVX 13 x 1525
06580732422	AVX 13 x 1525 TM
06580732432	AVX 13 x 1550
06580732432	AVX 13 x 1550 TM
06580732433	AVX 13 x 1550
06580732433	AVX 13 x 1550 TM
06580732442	AVX 13 x 1575
06580732442	AVX 13 x 1575 TM
06580732443	AVX 13 x 1575
06580732443	AVX 13 x 1575 TM
06580732452	AVX 13 x 1600
06580732452	AVX 13 x 1600 TM
06580732462	AVX 13 x 1625
06580732462	AVX 13 x 1625 TM
06580732472	AVX 13 x 1650
06580732472	AVX 13 x 1650 TM
06580732482	AVX 13 x 1675
06580732482	AVX 13 x 1675 TM
06580732492	AVX 13 x 1700
06580732492	AVX 13 x 1700 TM
06580732493	AVX 13 x 1700
06580732493	AVX 13 x 1700 TM
06580732502	AVX 13 x 1725
06580732512	AVX 13 x 1750
06580732512	AVX 13 x 1750 TM
06580732522	AVX 13 x 1775
06580732522	AVX 13 x 1775 TM
06580732523	AVX 13 x 1775
06580732523	AVX 13 x 1775 TM
06580732532	AVX 13 x 1800
06580732532	AVX 13 x 1800 TM
06580732542	AVX 13 x 1825
06580732542	AVX 13 x 1825 TM
06580732572	AVX 13 x 1900
06580732572	AVX 13 x 1900 TM
06580732592	AVX 13 x 1950
06580732592	AVX 13 x 1950 TM
06580790016	AVX 13 x 1325
06580790016	AVX 13 x 1325 TM
06580790017	AVX 10 x 1225
06580790022	AVX 10 x 875
06580790026	AVX 13 x 1250
06580790026	AVX 13 x 1250 TM
06580790028	AVX 13 x 1425
06580790028	AVX 13 x 1425 TM
06580792332	AVX 13 x 1300
06580792332	AVX 13 x 1300 TM
065810722441	AVX 13 x 1575

**MAN**

065810722441	AVX 13 x 1575 TM
51.95800-7394	KT 7005
51.95800-7396	KT 7006
51.95800-7397	KT 7005
51.96820-0238	KT 7006
51.96820-0239	KT 7005
51968200128	AVX 13 x 1475
51968200128	AVX 13 x 1475 TM
51968200132	AVX 10 x 1425
51968200143	AVX 13 x 1550
51968200143	AVX 13 x 1550 TM
51968200152	AVX 13 x 1290
51968200153	AVX 13 x 1550
51968200153	AVX 13 x 1550 TM
51968200153	AVX 13 x 1575
51968200153	AVX 13 x 1575 TM
51968200156	AVX 13 x 1650
51968200156	AVX 13 x 1650 TM
51968200162	AVX 13 x 1575
51968200162	AVX 13 x 1575 TM
51968200226	12 PK 1965 TM
51968200231	12 PK 1865 TM
51968200238	8 PK 880 TM
51968200239	8 PK 1376 TM
51968200242	10 PK 1860 TM
51968200243	8 PK 1275 TM
51968200250	12 PK 1515 TM
51968200253	12 PK 1300 TM
51968200257	8 PK 1327 TM
51968200265	9 PK 1200 TM
51968200269	4 PK 1290 TM
51968200270	14 PK 1305 TM
51968200271	5 PK 1482 TM
51968200272	8 PK 1635 TM
51968200273	8 PK 1920 TM
51968200280	8 PK 1327 TM
51968200304	4 PK 1455 TM
51968200310	10 PK 1580 TM
51968200313	8 PK 1515 TM
51968200314	4 PK 1380 TM
51968200317	4 PK 1390 TM
51968200322	8 PK 1158 TM
51968200335	8 PK 1920 TM
51968200336	8 PK 1635 TM
51968200344	8 PK 1635 TM
51968203001	AVX 13 x 1600
51968203001	AVX 13 x 1600 TM
51968206001	AVX 13 x 1600
51968206001	AVX 13 x 1600 TM
51968206027	AVX 13 x 1600
51968206027	AVX 13 x 1600 TM
51968206034	AVX 13 x 1450
51968206034	AVX 13 x 1450 TM
51968206046	AVX 13 x 1300
51968206046	AVX 13 x 1300 TM
51968206086	AVX 13 x 1300
51968206086	AVX 13 x 1300 TM
51968206117	AVX 13 x 1300
51968206117	AVX 13 x 1300 TM
6580410236	AVX 13 x 1375
6580410236	AVX 13 x 1375 TM
6580430236	AVX 13 x 1375
6580430236	AVX 13 x 1375 TM
6580432236	AVX 13 x 1375
6580432236	AVX 13 x 1375 TM

**MAN**

6580722331	AVX 13 x 1290
81968206018	AVX 13 x 1775
81968206018	AVX 13 x 1775 TM
81968206019	AVX 13 x 1275
81968206019	AVX 13 x 1275 TM
87680900118	AVX 10 x 950
87680900121	AVX 10 x 1000
87680900238	AVX 13 x 1425
87680900238	AVX 13 x 1425 TM
88968200001	6 PK 2200
K0001174284	AVX 13 x 1350 TM

**MASSEY FERGUSON**

1447778M91	AVX 13 x 1375
1447778M91	AVX 13 x 1375 TM
2614B159	AVX 13 x 1375
2614B159	AVX 13 x 1375 TM
3038999M1	AVX 13 x 1375
3038999M1	AVX 13 x 1375 TM
3581611M1	AVX 13 x 1375
3581611M1	AVX 13 x 1375 TM

**MAZDA**

024918381B	AVX 10 x 1000
030518381A	AVX 13 x 975
030579252	AVX 13 x 925
032418381	AVX 10 x 785
032418381A	AVX 10 x 785
050418381B	AVX 13 x 950
060518381	AVX 13 x 1000
0605183891	AVX 13 x 985
075018381A	AVX 13 x 1125
082018381	AVX 10 x 825
1037660	ZRK 1184
1049578	6 PK 1975
1049613	6 PK 2100
1361733	ZRK 1335
156218381	AVX 10 x 825
175713715	AVX 10 x 888
175718381	AVX 10 x 800
1A2318381	4 PK 870
1E0315907	6 PK 1735
1E0315907A	6 PK 1735
1E0315907B	6 PK 1735
1E0315908	6 PK 1440
1E0315908A	6 PK 1440
1E0315909	6 PK 1900
1E0315909A	6 PK 1900
1E0315909B	6 PK 1900
1E0315909D	6 PK 1900
1E0318381	6 PK 858
1E0318381A	6 PK 858
1E0512205	ZRK 1172
1E0512730	325ST
1E0515907	6 PK 1751
1E0515908	6 PK 1775
1E0515909	6 PK 1930
1E0518381	6 PK 1185
1E0612205	ZRK 1172
1E0612700	231ST
1E0612700A	231ST
1E0612700B	231ST
1E0712205	ZRK 1000
1E0712700	324ST
1E0712700A	316ST





Teilenummer Part number	Abmessung Dimension
----------------------------	------------------------

Teilenummer Part number	Abmessung Dimension
----------------------------	------------------------

Teilenummer Part number	Abmessung Dimension
----------------------------	------------------------

**MAZDA**

1E0712700B	316ST
1E0712720	320ST
1E0713823	ZRK 1000
1E0713823A	ZRK 1000
1E0715907	5 PK 1140
1E0715907A	5 PK 1140
1E0715907B	5 PK 1140
1E0715909	5 PK 675
1E0718381	5 PK 886
1E0718381A	5 PK 886
1E0723951	304UT
1E0723951A	304UT
1E0723951B	304UT
1E0723951C	304UT
1E1012700	231ST
1E1012700A	231ST
1E1012700C	231ST
1E1115907	6 PK 1610
1E1212205A	ZRK 1000
1E1212205B	ZRK 1000
1E1223951	304UT
1N1515909	4 PK 813
1N2018381	4 PK 1110
227618381A	AVX 13 x 950
227618381B	AVX 13 x 900
232913715	AVX 10 x 825
267718381	AVX 13 x 850
3252729	AVX 13 x 1100
3707248	6 PK 2080
387418381	AVX 13 x 1075
3BC715909C	4 PK 966
489318382	AVX 13 x 1225
7204039	3 PK 685
811818381	AVX 13 x 875
831118381A	AVX 10 x 785
856215906	AVX 13 x 1050
887118381	AVX 10 x 800
95WF6C301H	6 PK 1900
96423837	6 PK 975
96FB6C301AC	6 PK 858
96FB6C301BC	6 PK 1735
96FB6C301CD	6 PK 1440
96FF6268DA	ZRK 1000
96FF6C301AE	5 PK 886
96FF6C301BE	5 PK 1140
96FF6C301CD	5 PK 675
96MF6C301A	6 PK 1185
96MF6C301B	6 PK 1751
96MF6C301C	6 PK 1930
96MF6C301D	6 PK 1775
97FF6C301AC	5 PK 1140
98BB6C301BA	6 PK 2100
AJ0315908	6 PK 2080
AJ0315908A	6 PK 2080
AJ0315908B	6 PK 2080
AJ0318381	3 PK 685
AJ5215908	6 PK 2080
AM0618381A	AVX 13 x 950
AS0115907C	4 PK 900
AS0315909	6 PK 1795
AY14060922	6 PK 925
B30115909	4 PK 950
B30318381	AVX 10 x 888
B30318381A	AVX 10 x 888
B36015907A	4 PK 875

**MAZDA**

B36615907	4 PK 890
B36615908	4 PK 884
B36615908A	4 PK 884
B36615909	4 PK 1005
B3C715907B	4 PK 845
B3C715907C	4 PK 850
B3C715909A	4 PK 962
B3C715909C	4 PK 966
B3C718381	4 PK 875
B3C718381A	4 PK 875
B3C718381B	4 PK 875
B3J215909	4 PK 966
B3P515908	4 PK 875
B3P715908	4 PK 875
B50115908	4 PK 890
B58718381	4 PK 884
B58815909	4 PK 1015
B59515909	4 PK 995
B59615907	4 PK 890
B59615909	4 PK 995
B59618381	4 PK 884
B59712205	ZRK 1281
B5A118381	4 PK 875
B5C715909	4 PK 954
B5C815909	4 PK 954
B60118381	AVX 10 x 888
B60118381A	AVX 10 x 888
B61115908	AVX 13 x 950
B61215909A	4 PK 980
B61H18381	AVX 13 x 900
B61P15907	4 PK 870
B61P15907A	4 PK 855
B63012700A	950UT
B63012700B	950UT
B63012700C	950UT
B63012700D	950UT
B63012700E	950UT
B63015907	4 PK 875
B63015907A	4 PK 875
B63015907B	4 PK 875
B63112700C	950UT
B63H15909	4 PK 954
B65712205	ZRK 1281
B66012205A	ZRK 1008
B66012205B	ZRK 1008
B66012205C	ZRK 1008
B66012700A	951ST
B66012700B	951ST
B66012700C	951ST
B66012700D	951ST
B66012700E	951ST
B66012700F	951ST
B66012730B	952UT
B66012730C	952UT
B66015908	4 PK 890
B66115909	4 PK 995
B6A915908A	4 PK 905
B6A915909A	4 PK 1005
B6BF15907	4 PK 890
B6BF18381	4 PK 884
B6BF18381A	4 PK 890
B6C715909	4 PK 950
B6DG15909	4 PK 995
B6S712205	ZRK 1281
B6S712205A	ZRK 1281

**MAZDA**

B6S712205B	ZRK 1281
B6S712205C	ZRK 1281
B6S712205C9	ZRK 1281
B6S712205D	ZRK 1281
B6S715909	4 PK 1015
B6S718381A	AVX 13 x 900
B6S718381AB	AVX 13 x 900
B6S718381B	AVX 13 x 900
B6SF18381	AVX 13 x 900
B6SF18381A	AVX 13 x 900
B6SF18381B	AVX 13 x 900
BP0112205	ZRK 1071
BP0112205A	ZRK 1071
BP0112205B	ZRK 1071
BP0112205B9	ZRK 1071
BP0112SF0	ZRK 1071
BP0212205	ZRK 1071
BP0212205A	ZRK 1071
BP0212205B9	ZRK 1071
BP2515908	4 PK 890
BP2515908A	4 PK 890
BP4W15907A	4 PK 860
BP4W15907B	4 PK 855
BP4W18381	4 PK 884
BPD415909	4 PK 1005
BPE615909	4 PK 1005
BPE715909	4 PK 1005
BPE815908	4 PK 850
BPE815909A	4 PK 950
BPF315909A	4 PK 950
BPH715909	4 PK 1005
C20112201	ZRK 1172
C20112201A	ZRK 1172
C20112500	231ST
C20112500A	231ST
C20112500B	231ST
CY0115908A	6 PK 1138
CY0115908B	6 PK 1138
CY0115908C	6 PK 1138
D53015907	4 PK 870
D53015909	4 PK 1080
E30115907	AVX 13 x 1125
E301181	AVX 10 x 960
E30118381	AVX 10 x 960
E33115907	4 PK 1180
E35618381	AVX 10 x 960
E35618381X	AVX 10 x 965
E56115907	4 PK 1040
F20115907A	5 PK 1015
F20115908A	5 PK 950
F20115909A	5 PK 1060
F20118381A	3 PK 763
F20118908A	5 PK 950
F20212205	ZRK 1168
F202122059A	ZRK 1168
F20312205	ZRK 1168
F203122059A	ZRK 1168
F20312205X	ZRK 1168
F21012205	ZRK 1168
F23015909	5 PK 1060
F26218381A	3 PK 763
F2E618381X	AVX 13 x 785
F2F618381	3 PK 763
F53E8K543AA	3 PK 685
F80112205	ZRK 1042

Teilenummer Part number	Abmessung Dimension	Teilenummer Part number	Abmessung Dimension	Teilenummer Part number	Abmessung Dimension
<b>MAZDA</b>		<b>MAZDA</b>		<b>MAZDA</b>	
F80112700C	955ST	FP0112205A	ZRK 1209	KF3315907	4 PK 920
F80115381A	4 PK 813	FP0112205A9	ZRK 1209	KFC815907	4 PK 905
F80212205	ZRK 1042	FP0112700	243UT	KJ0115907	8 PK 1635 TM
F80212205X	ZRK 1042	FP0112700A	243UT	KJ0118381A	7 PK 1605
F80215907A	5 PK 975	FP0115907	5 PK 1025	KL0112205	ZRK 1234
F80612205	ZRK 1115	FP0115907A9	5 PK 1025	KL0112730A	196UT
F80715907	5 PK 1015	FP0115909	5 PK 1145	KL0112740	197UT
F80715908A	5 PK 950	FP0215909	5 PK 1145	KL0112750	198UT
F80715909A	5 PK 1055	FP0215909A	5 PK 1145	KL0212750	198UT
F80812205	ZRK 1115	FP0415907A	5 PK 1025	KL4715907	4 PK 920
F80815381	4 PK 875	FP0512700A	243UT	KL4715908	5 PK 1000
F80912205	ZRK 1115	FP0512700B	243UT	KL4715908A	5 PK 1000
F809122059A	ZRK 1115	FS0112205	ZRK 1210	KL7015908	5 PK 1000
F80912205X	ZRK 1115	FS0112205A	ZRK 1210	KL7015908A	5 PK 1000
F82A15909	4 PK 980	FS0112205A9	ZRK 1210	KLY212SJ0	198UT
F82A18381A	4 PK 925	FS0112205AG	ZRK 1210	L32715909	6 PK 2215
F82B15909	4 PK 980	FS0112700A	186UT	L32715909A	6 PK 2215
F85118381A	AVX 13 x 775	FS0112700B	186UT	L32715909B	6 PK 2215
F85218381	AVX 13 x 950	FS0112730A	187UT	L32915909	6 PK 2305
F87418381	AVX 13 x 825	FS0212205	ZRK 1210	L32915909A	6 PK 2305
F8AG18381X	AVX 13 x 950	FS0505909	5 PK 1165	L32915909B	6 PK 2305
F8B212205	ZRK 1162	FS0512700	186UT	L33615909	6 PK 2285
F8B212205A	ZRK 1162	FS0512700A	186UT	L33615909A	6 PK 2285
F8B212205A9	ZRK 1162	FS0512700B	186UT	L33615909B	6 PK 2285
F8B518381	4 PK 813	FS0515907	5 PK 1030	L37315909	6 PK 1330
F8B518381C	4 PK 813	FS0515909	5 PK 1165	L37G15909	6 PK 2285
FE0112205	ZRK 1044	FS0518381	4 PK 920	L37K15909	6 PK 2315
FE0212205	ZRK 1044	FS1115907	5 PK 1030	L3B615909	6 PK 2285
FE0312205	ZRK 1120	FS1115907A	5 PK 1030	L3K915909A	6 PK 2315
FE0412205	ZRK 1120	FS1215909	5 PK 1165	L51015909A	6 PK 2285
FE0512205	ZRK 1335	FS1215909A	5 PK 1165	L51015909B	6 PK 2285
FE0612205	ZRK 1335	FS1215909B	5 PK 1165	L51015909C	6 PK 2285
FE0812205	ZRK 1335	FS1218381	4 PK 920	L53815909A	6 PK 2285
FE0912205	ZRK 1335	FS1218381A	4 PK 920	LF1715909	6 PK 2160
FE09122059A	ZRK 1335	FS1E18381	4 PK 925	LF1715909A	6 PK 2160
FE0912205X	ZRK 1335	FS5918381	4 PK 920	LF1715909B	6 PK 2160
FE1361733	ZRK 1335	FS5918381A	4 PK 920	LF1915909	6 PK 2255
FE1H12205	ZRK 1167	FS5918381B	4 PK 920	LF1915909A	6 PK 2255
FE1H12205A	ZRK 1167	FSJ218381	4 PK 920	LF1915909B	6 PK 2255
FE1H12205A9	ZRK 1167	FSM318381	4 PK 920	LF4J15909A	6 PK 2240
FE1H12205X	ZRK 1167	G60118381	AVX 13 x 1060 TM	LF4J15909B	6 PK 2240
FE1H12700A	953ST	GY0118381	3 PK 685	LF5015908	5 EPK 694
FE1H12730	954UT	GY0215908	6 PK 2100	LF5015909	6 PK 1305
FE1H12730A	954UT	GY0218381A	6 PK 2100	LF5015909A	6 PK 1305
FE1H15907	AVX 13 x 825	J50315381A	6 PK 1400	LF5115909	6 PK 1305
FE1J12205	ZRK 1167	J50315908	4 PK 1030	LF9J15909A	6 PK 2255
FE312205	ZRK 1283	JE4815908	4 PK 1020	LF9M15909A	6 PK 2170
FE3N12205	ZRK 1283	JE5315908A	4 PK 1005	LFG115909B	6 PK 2245
FE3N122059A	ZRK 1283	JE5318381	4 PK 1005	LFH115909B	6 PK 2260
FE3N12205X	ZRK 1283	JE7415907	4 PK 913	LFJ515909B	6 PK 2160
FE3N12730	956UT	JE7415908	5 PK 985	N24915906B	AVX 13 x 1075
FE4618381	AVX 13 x 1000	JF0112205	ZRK 1228	N30413715	AVX 10 x 900
FE4N15909A	5 PK 1060	JF0112205A	ZRK 1228	N32615908	AVX 13 x 975
FE6518381	AVX 13 x 850	JF0112205B	ZRK 1228	N32615909	AVX 13 x 1050
FE7018381	AVX 13 x 750	JF0112205C	ZRK 1228	N32615909X	AVX 13 x 1060
FE7912205	ZRK 1120	JF0112205D	ZRK 1228	N33213813A	AVX 10 x 975
FE8118381	AVX 13 x 1025	JF0118381A	AVX 13 x 1025	N35018381	AVX 10 x 800
FEB118351	AVX 13 x 1025	JF0118381X	AVX 13 x 1015	N35018381X	AVX 10 x 800
FEB118381	AVX 13 x 1025	JF0118381X	AVX 13 x 1015 TM	N37012813X	AVX 10 x 960
FEMJ18381	6 PK 1185	K80515907A	4 PK 920	N37013813A	AVX 10 x 960
FEY812205	ZRK 1120	K80515907B	4 PK 920	N3A115907	6 PK 925
FEY912205	ZRK 1120	K80515908A	5 PK 1015	N3A115908	6 PK 1045
FEY9122059A	ZRK 1120	K80515908B	5 PK 1015	N3A118381	5 PK 1355
FEY912205X	ZRK 1120	K80518381A	5 PK 860	N3H115908	4 PK 780
FP0112205	ZRK 1209	K80518381B	5 PK 860	N3H115908A	4 PK 780



Teilenummer Part number	Abmessung Dimension
----------------------------	------------------------

Teilenummer Part number	Abmessung Dimension
----------------------------	------------------------

Teilenummer Part number	Abmessung Dimension
----------------------------	------------------------

**MAZDA**

N3H118381	5 PK 820
N3H118381A	5 PK 820
N3R115908	4 PK 780
N3R118381	5 PK 820
PN1118381	AVX 13 x 875
PN1118381X	AVX 13 x 875
PN1215909	AVX 13 x 1060 TM
PN1215909	AVX 13 x 1075
PN1315909	AVX 13 x 925
PN4018381	AVX 13 x 900
R20112205	ZRK 1264
R20112205A	ZRK 1264
RF0118381	AVX 13 x 1100
RF0118381X	AVX 13 x 1125
RF0312205	ZRK 1218
RF0312720	808UT
RF0312731	808UT
RF0315930	AVX 13 x 925
RF0315980	AVX 13 x 925
RF0315980X	AVX 13 x 925
RF0515980	AVX 13 x 1050
RF0515980X	AVX 13 x 1030
RF1G12205	ZRK 1401
RF1S18380A	2/AVX 13 x 1050
RF2A-12-205	ZRK 1586
RF2A-12-205A	ZRK 1586
RF2A-12-205B	ZRK 1586
RF2A12700	164UT
RF2A12730	165UT
RF4312205	ZRK 1218
RF5C12205	ZRK 1449
RF5C12205	ZRK 1589
RF5C12205A	ZRK 1449
RF5C12205A	ZRK 1589
RF5C12205A9	ZRK 1449
RF5C12205A9	ZRK 1589
RF5C15909A	8 PK 1175
RF5D15909	8 PK 1225
RF5G15909	8 PK 1230
RF7112205	ZRK 1226
RF7112205X	ZRK 1226
RF7112700C	182ST
RF7112730A	183UT
RF7115907A	AVX 13 x 850
RF7115907B	AVX 13 x 850
RF7115908	AVX 13 x 900
RF7912205	ZRK 1226
RF7J12205	ZRK 1542
RF7J15909	8 PK 1175
RF7L15909	8 PK 1225
RF8G15909	8 PK 1230
RFC612700	182ST
RFC618381	AVX 13 x 850
RFG115908	AVX 13 x 925
RFG118380	AVX 13 x 850
RFG1183841B	AVX 13 x 850
RS7L15909	8 PK 1225
SE0178022	AVX 13 x 1450
SE0818381	AVX 13 x 1100
W06532611	AVX 13 x 875
WL0112205	ZRK 1393
WL01-12-205	ZRK 1393
WL0118381	AVX 13 x 1100
WL5118380	AVX 13 x 1100
WL5118380A	AVX 13 x 1100

**MAZDA**

WL8112205	ZRK 1393
XS2E8620HA	6 PK 2080
XS2Z8620HA	6 PK 2080
Y40112730	332UT
Y40112770	331ST
Y40112770A	331ST
Y40112770B	331ST
Y40112770C	331ST
Y40115907	6 PK 1345
Y40115908	6 PK 1710
Y60112205	ZRK 1460
Y60112205A	ZRK 1460
Y60115909	6 PK 975
Y60115909A	6 PK 975
Y60215909	6 PK 800
Y70112205	ZRK 1280
Y70112700A	520ST
Y70112730	436UT
YF0912205	ZRK 1184
YF0912730	555UT
YF0915908	6 PK 2100
YF0915909	6 PK 1975
YF7112205	ZRK 1184
YF7112205A	ZRK 1184
Z50112205	ZRK 1448
Z50112730	445UT
Z50115909	4 PK 995
Z502-12-205	ZRK 1587
Z60115909	6 PK 1870
Z60115909A	6 PK 1863
ZG0115909A	6 PK 2013
ZJ0115909A	6 PK 2013
ZJ3815908B	6 PK 1840
ZJ3815909	6 PK 1840
ZJ3815909B	6 PK 1840
ZJ3815909C	6 PK 1840
ZL0115907	4 PK 890
ZZS418381	4 PK 665
ZZS618381	4 PK 835

**MERCEDES-BENZ**

0005500033	408UR
0009930696	6 PK 2360
0009931496	6 PK 2585
0009931995	AVX 13 x 950
0009931995	AVX 13 x 950 TM
0009931996	5 PK 1310
0009932096	5 PK 1745
0009932696	9 PK 1888 TM
0009932896	8 PK 2035
0009933396	4 PK 790
0009933496	3 PK 855
0009933696	6 PK 2270
0009933796	6 PK 2373
0009934596	8 PK 2045 TM
0009934696	8 PK 1985 TM
0009936696	7 PK 2315
0009936796	7 PK 2415
0009937296	9 PK 1888 TM
0009937496	9 PK 1725 TM
0009937796	9 PK 1920 TM
0009937896	9 PK 2871 TM
0009938096	11 PK 2871 TM
0009938196	8 PK 1202 TM
0009938296	9 PK 1920 TM

**MERCEDES-BENZ**

0009938496	9 PK 1690 TM
0009939996	10 PK 1845 TM
0009970196	7 PK 2035
0009970892	AVX 10 x 938
0009970892	AVX 10 x 940
0009972492	AVX 10 x 850
0009975192	AVX 13 x 975
0009975192	AVX 13 x 975 TM
0009975492	AVX 13 x 1000
0009975492	AVX 13 x 1000 TM
0009975892	AVX 13 x 950
0009975892	AVX 13 x 950 TM
0009975992	AVX 10 x 875
0009976192	AVX 10 x 960
0009976692	AVX 13 x 1625
0009976692	AVX 13 x 1625 TM
0009976792	AVX 13 x 1425
0009976792	AVX 13 x 1425 TM
0009976892	AVX 10 x 950
0009976992	AVX 10 x 775
0009977092	AVX 13 x 1025
0009977092	AVX 13 x 1025 TM
0009977192	AVX 10 x 925
0009977292	AVX 10 x 775
0009977392	AVX 10 x 960
0009977592	AVX 10 x 913
0009977692	AVX 10 x 1100
0009977792	AVX 13 x 1325
0009977792	AVX 13 x 1325 TM
0009978192	AVX 13 x 1425
0009978192	AVX 13 x 1425 TM
0009978392	AVX 10 x 925
0009978592	AVX 13 x 1000
0009978592	AVX 13 x 1000 TM
0009978692	AVX 13 x 1250
0009978692	AVX 13 x 1250 TM
0009978792	AVX 13 x 1275
0009978792	AVX 13 x 1275 TM
0009978892	AVX 13 x 1325
0009978892	AVX 13 x 1325 TM
0009978992	AVX 13 x 1450
0009978992	AVX 13 x 1450 TM
0009979092	AVX 13 x 1500
0009979092	AVX 13 x 1500 TM
0009979192	AVX 13 x 1525
0009979292	AVX 13 x 1350
0009979292	AVX 13 x 1350 TM
0009979592	AVX 13 x 1550
0009979592	AVX 13 x 1550 TM
0009979692	AVX 13 x 1050
0009979692	AVX 13 x 1050 TM
0009979792	AVX 13 x 1625
0009979792	AVX 13 x 1625 TM
0009979892	AVX 13 x 1300
0009979892	AVX 13 x 1300 TM
0019930696	8 PK 1715 TM
0019931796	6 PK 2285
0019931896	6 PK 2404
0019932596	8 PK 1610 TM
0019932796	9 PK 2140 TM
0019932896	5 PK 1790
0019932996	5 PK 1310
0019933096	5 PK 1745
0019933496	6 PK 2155
0019933696	7 PK 1970





Teilenummer Part number	Abmessung Dimension
----------------------------	------------------------

Teilenummer Part number	Abmessung Dimension
----------------------------	------------------------

Teilenummer Part number	Abmessung Dimension
----------------------------	------------------------

**MERCEDES-BENZ**

0019933896	6 EPK 691
0019933996	6 EPK 691
0019934796	6 PK 1330
0019934896	9 PK 1920 TM
0019935696	9 PK 2125 TM
0019935796	9 PK 1725 TM
0019935996	10 PK 1845 TM
0019936096	11 PK 2020 TM
0019936196	11 PK 2040 TM
0019936396	9 PK 1920 TM
0019937196	9 PK 1920 TM
0019937296	9 PK 2871 TM
0019937496	11 PK 2871 TM
0019937596	7 PK 2035
0019937696	3 EPK 806
0019937796	5 PK 1745
0019937896	6 PK 2315
0019938296	5 PK 1310
0019938396	6 PK 2360
0019938696	6 PK 2260
0019970092	AVX 13 x 1375
0019970092	AVX 13 x 1375 TM
0019970292	AVX 13 x 1550
0019970292	AVX 13 x 1550 TM
0019970392	AVX 13 x 1200
0019970392	AVX 13 x 1200 TM
0019971192	AVX 13 x 1550
0019971192	AVX 13 x 1550 TM
0019971592	AVX 13 x 1325
0019971592	AVX 13 x 1325 TM
0019972192	AVX 10 x 960
0019972392	AVX 13 x 1325
0019972392	AVX 13 x 1325 TM
0019972592	AVX 13 x 1400
0019972592	AVX 13 x 1400 TM
0019972692	AVX 13 x 1000
0019972692	AVX 13 x 1000 TM
0019972892	AVX 10 x 800
0019973292	AVX 13 x 1500
0019973292	AVX 13 x 1500 TM
0019973392	AVX 13 x 1525
0019973592	AVX 13 x 1625
0019973592	AVX 13 x 1625 TM
0019973692	AVX 13 x 1375
0019973692	AVX 13 x 1375 TM
0019973792	AVX 10 x 900
0019973892	AVX 10 x 1225
0019974092	AVX 13 x 975
0019974092	AVX 13 x 975 TM
0019974192	AVX 13 x 800
0019974192	AVX 13 x 800 TM
0019974292	AVX 10 x 800
0019974392	AVX 13 x 1075
0019974392	AVX 13 x 1075 TM
0019974592	AVX 10 x 875
0019974992	AVX 13 x 985
0019975092	AVX 13 x 1400 TM
0019975192	AVX 13 x 1375
0019975192	AVX 13 x 1375 TM
0019975592	AVX 13 x 1125
0019975592	AVX 13 x 1125 TM
0019975692	AVX 13 x 1475
0019975692	AVX 13 x 1475 TM
0019975792	AVX 13 x 1525
0019975892	AVX 13 x 1350

**MERCEDES-BENZ**

0019975892	AVX 13 x 1350 TM
0019976092	AVX 13 x 975
0019976092	AVX 13 x 975 TM
0019976096	11 PK 2020 TM
0019976196	11 PK 2040 TM
0019976492	AVX 13 x 750
0019976492	AVX 13 x 750 TM
0019976792	AVX 13 x 1375
0019976792	AVX 13 x 1375 TM
0019976892	AVX 13 x 1125
0019976892	AVX 13 x 1125 TM
0019976992	AVX 13 x 1475
0019976992	AVX 13 x 1475 TM
0019977192	AVX 13 x 1375
0019977192	AVX 13 x 1375 TM
0019977292	AVX 13 x 1475
0019977292	AVX 13 x 1475 TM
0019977392	AVX 13 x 1475
0019977392	AVX 13 x 1475 TM
0019977492	AVX 13 x 1525
0019977492	AVX 13 x 1525 TM
0019977592	AVX 13 x 1450
0019977592	AVX 13 x 1450 TM
0019977692	AVX 13 x 1200
0019977692	AVX 13 x 1200 TM
0019977792	AVX 13 x 1475
0019977792	AVX 13 x 1475 TM
0019977992	AVX 13 x 1325
0019977992	AVX 13 x 1325 TM
0019978092	AVX 13 x 875
0019978092	AVX 13 x 875 TM
0019978692	AVX 13 x 1125
0019978692	AVX 13 x 1125 TM
0019978792	AVX 13 x 1075
0019978792	AVX 13 x 1075 TM
0019978892	AVX 13 x 1900
0019978892	AVX 13 x 1900 TM
0019979092	AVX 13 x 1500
0019979092	AVX 13 x 1500 TM
0019979192	AVX 13 x 1525
0019979492	AVX 13 x 1100
0019979492	AVX 13 x 1100 TM
0019979692	AVX 13 x 1100
0019979692	AVX 13 x 1100 TM
0019979792	AVX 13 x 1525
0019979792	AVX 13 x 1525 TM
0019979892	AVX 13 x 1525
0019979992	AVX 13 x 1625
0019979992	AVX 13 x 1625 TM
0029930896	6 PK 2225
0029930996	6 PK 2140
0029932496	8 PK 1215 TM
0029932996	8 PK 2045 TM
0029933096	6 PK 2390
0029933296	6 PK 2215
0029934296	7 PK 2035
0029970092	AVX 13 x 1500
0029970092	AVX 13 x 1500 TM
0029970192	AVX 13 x 1600
0029970192	AVX 13 x 1600 TM
0029970292	AVX 13 x 1600
0029970292	AVX 13 x 1600 TM
0029970392	AVX 13 x 1625
0029970392	AVX 13 x 1625 TM
0029970492	AVX 13 x 1325

**MERCEDES-BENZ**

0029970492	AVX 13 x 1325 TM
0029970592	AVX 13 x 1475
0029970592	AVX 13 x 1475 TM
0029970692	AVX 10 x 1000
0029970792	AVX 13 x 975
0029970792	AVX 13 x 975 TM
0029970892	AVX 10 x 935
0029970892	AVX 10 x 938
0029970992	AVX 10 x 938
0029970992	AVX 10 x 940
0029971092	AVX 10 x 950
0029971392	AVX 13 x 1475
0029971392	AVX 13 x 1475 TM
0029971692	AVX 13 x 1375
0029971692	AVX 13 x 1375 TM
0029971992	AVX 10 x 1000
0029972092	AVX 10 x 975
0029972392	AVX 10 x 1215
0029972592	AVX 13 x 850
0029972692	AVX 13 x 925
0029972692	AVX 13 x 925 TM
0029972792	AVX 10 x 740
0029972892	AVX 10 x 740
0029972892	AVX 10 x 940
0029973092	AVX 13 x 850
0029973192	AVX 10 x 1225
0029973292	AVX 10 x 1225
0029973392	AVX 13 x 1300
0029973392	AVX 13 x 1300 TM
0029973592	AVX 10 x 980
0029973592	AVX 13 x 900 TM
0029973692	AVX 13 x 1100
0029973692	AVX 13 x 1100 TM
0029973892	AVX 13 x 1025
0029973892	AVX 13 x 1025 TM
0029974192	AVX 13 x 1250
0029974192	AVX 13 x 1250 TM
0029974292	AVX 13 x 1290
0029974292	AVX 13 x 1300
0029974292	AVX 13 x 1300 TM
0029974392	AVX 13 x 1375
0029974392	AVX 13 x 1375 TM
0029974492	AVX 13 x 1350
0029974492	AVX 13 x 1350 TM
0029974692	AVX 13 x 1125
0029974692	AVX 13 x 1125 TM
0029974792	AVX 10 x 813
0029974892	AVX 13 x 775
0029974992	AVX 10 x 850
0029975092	AVX 10 x 1184
0029975192	AVX 10 x 1184
0029975292	AVX 13 x 950
0029975292	AVX 13 x 950 TM
0029975392	AVX 13 x 825
0029975492	AVX 13 x 1100
0029975492	AVX 13 x 1100 TM
0029975592	AVX 10 x 975
0029975792	AVX 10 x 825
0029975892	AVX 10 x 975
0029975992	AVX 13 x 1425
0029975992	AVX 13 x 1425 TM
0029976292	AVX 10 x 1150
0029976392	AVX 10 x 1150
0029976792	AVX 13 x 925
0029976792	AVX 13 x 925 TM



Teilenummer Part number	Abmessung Dimension
----------------------------	------------------------

Teilenummer Part number	Abmessung Dimension
----------------------------	------------------------

Teilenummer Part number	Abmessung Dimension
----------------------------	------------------------

**MERCEDES-BENZ****MERCEDES-BENZ****MERCEDES-BENZ**

0029976892	AVX 13 x 1150
0029976892	AVX 13 x 1150 TM
0029976992	AVX 13 x 1150
0029976992	AVX 13 x 1150 TM
0029977092	AVX 10 x 800
0029977192	AVX 10 x 975
0029977292	AVX 10 x 975
0029977392	AVX 13 x 1275
0029977392	AVX 13 x 1275 TM
0029977492	AVX 13 x 1525
0029977592	AVX 13 x 1525
0029977592	AVX 13 x 1525 TM
0029977692	AVX 10 x 1150
0029978292	AVX 13 x 1050
0029978292	AVX 13 x 1050 TM
0029978392	AVX 10 x 925
0029978492	AVX 10 x 888
0029978592	AVX 13 x 1125
0029978592	AVX 13 x 1125 TM
0029978692	AVX 13 x 825
0029978792	AVX 13 x 1200
0029978792	AVX 13 x 1200 TM
0029978992	AVX 10 x 1075
0029978992	AVX 10 x 1075 TM
0029979092	AVX 13 x 1150
0029979092	AVX 13 x 1150 TM
0029979492	AVX 13 x 785
0029979592	AVX 10 x 960
0029979792	AVX 13 x 1075
0029979792	AVX 13 x 1075 TM
0029979892	AVX 13 x 1225
0029979892	AVX 13 x 1225 TM
0029979992	AVX 13 x 1375
0029979992	AVX 13 x 1375 TM
0039970192	AVX 13 x 1025
0039970192	AVX 13 x 1025 TM
0039970292	AVX 13 x 1375
0039970292	AVX 13 x 1375 TM
0039970392	AVX 13 x 1350
0039970392	AVX 13 x 1350 TM
0039970492	AVX 13 x 1700
0039970492	AVX 13 x 1700 TM
0039970592	AVX 13 x 1150
0039970592	AVX 13 x 1150 TM
0039970692	AVX 13 x 1150
0039970692	AVX 13 x 1150 TM
0039970792	AVX 13 x 1250
0039970792	AVX 13 x 1250 TM
0039970892	AVX 10 x 675
0039971092	AVX 13 x 1575
0039971092	AVX 13 x 1575 TM
0039971492	AVX 13 x 950
0039971492	AVX 13 x 950 TM
0039971592	AVX 13 x 1500
0039971592	AVX 13 x 1500 TM
0039971692	AVX 13 x 1125
0039971692	AVX 13 x 1125 TM
0039971992	AVX 13 x 1375
0039971992	AVX 13 x 1375 TM
0039972392	AVX 13 x 1475
0039972392	AVX 13 x 1475 TM
0039972492	AVX 13 x 725
0039972592	AVX 10 x 913
0039972692	AVX 13 x 1200
0039972692	AVX 13 x 1200 TM

0039972792	AVX 10 x 1250
0039972892	AVX 10 x 1250
0039972992	AVX 13 x 1475
0039972992	AVX 13 x 1475 TM
0039973092	AVX 13 x 1525
0039973092	AVX 13 x 1525 TM
0039973192	AVX 13 x 1500
0039973192	AVX 13 x 1500 TM
0039973392	AVX 13 x 1325
0039973392	AVX 13 x 1325 TM
0039973492	AVX 10 x 938
0039973492	AVX 10 x 940
0039973592	AVX 10 x 980
0039973692	AVX 13 x 1300
0039973692	AVX 13 x 1300 TM
0039973792	AVX 13 x 1700
0039973792	AVX 13 x 1700 TM
0039974192	AVX 13 x 1650
0039974192	AVX 13 x 1650 TM
0039974292	AVX 13 x 1400
0039974292	AVX 13 x 1400 TM
0039974392	AVX 13 x 1400
0039974392	AVX 13 x 1400 TM
0039974492	AVX 10 x 1200
0039974592	AVX 10 x 1200
0039974692	AVX 10 x 1275
0039974792	AVX 13 x 1750
0039974792	AVX 13 x 1750 TM
0039974892	AVP 13 x 1950 TM
0039974892	AVX 13 x 1950
0039974892	AVX 13 x 1950 TM
0039974992	AVP 13 x 1950 TM
0039974992	AVX 13 x 1950
0039974992	AVX 13 x 1950 TM
0039975092	AVX 13 x 1000
0039975092	AVX 13 x 1000 TM
0039975292	AVX 13 x 1250
0039975292	AVX 13 x 1250 TM
0039975392	AVX 13 x 1290
0039975392	AVX 13 x 1300
0039975392	AVX 13 x 1300 TM
0039975492	AVX 13 x 1475
0039975492	AVX 13 x 1475 TM
0039975592	AVX 10 x 913
0039975692	AVX 13 x 1400
0039975692	AVX 13 x 1400 TM
0039975792	AVX 13 x 1200
0039975792	AVX 13 x 1200 TM
0039975892	AVX 13 x 1900
0039975892	AVX 13 x 1900 TM
0039975992	AVX 13 x 1200
0039975992	AVX 13 x 1200 TM
0039976092	AVX 13 x 1900
0039976092	AVX 13 x 1900 TM
0039976292	AVX 13 x 1325
0039976292	AVX 13 x 1325 TM
0039976392	AVX 10 x 1225
0039976492	AVX 10 x 763
0039976892	AVX 10 x 970
0039976992	AVX 13 x 1150
0039976992	AVX 13 x 1150 TM
0039977292	AVX 10 x 1215
0039977392	AVX 13 x 1900
0039977392	AVX 13 x 1900 TM
0039977492	AVX 13 x 1200

0039977492	AVX 13 x 1200 TM
0039977592	AVX 13 x 1900
0039977592	AVX 13 x 1900 TM
0039977792	AVX 13 x 1325
0039977792	AVX 13 x 1325 TM
0039977892	AVX 13 x 1525
0039977992	AVX 13 x 1650
0039977992	AVX 13 x 1650 TM
0039978292	AVX 13 x 850
0039978392	AVX 13 x 1550
0039978392	AVX 13 x 1550 TM
0039978592	AVX 13 x 1325
0039978592	AVX 13 x 1325 TM
0039978692	AVX 13 x 1200
0039978692	AVX 13 x 1200 TM
0039979192	AVP 13 x 2050 TM
0039979292	AVP 13 x 2050 TM
0039979392	AVX 13 x 1275
0039979392	AVX 13 x 1275 TM
0039979492	AVX 10 x 700
0039979592	AVX 10 x 1184
0049970092	AVX 13 x 1375
0049970092	AVX 13 x 1375 TM
0049970192	AVX 13 x 1300
0049970192	AVX 13 x 1300 TM
0049970292	AVX 13 x 1300
0049970292	AVX 13 x 1300 TM
0049970392	AVX 10 x 763
0049970492	AVX 13 x 1285
0049970592	AVX 13 x 950
0049970592	AVX 13 x 950 TM
0049970892	AVX 10 x 930
0049971292	AVX 13 x 1275
0049971292	AVX 13 x 1275 TM
0049971392	AVX 13 x 1450
0049971392	AVX 13 x 1450 TM
0049971395	AVX 13 x 1450
0049971395	AVX 13 x 1450 TM
0049971792	AVX 13 x 1325
0049971792	AVX 13 x 1325 TM
0049972792	AVX 13 x 1800
0049972792	AVX 13 x 1800 TM
0049973092	AVX 13 x 1725
0049973192	AVX 13 x 1950
0049973192	AVX 13 x 1950 TM
0049973392	AVX 13 x 1350
0049973392	AVX 13 x 1350 TM
0049973492	AVX 13 x 1600
0049973492	AVX 13 x 1600 TM
0049973592	AVX 13 x 875
0049973592	AVX 13 x 875 TM
0049973692	AVX 13 x 975
0049973692	AVX 13 x 975 TM
0049973992	AVX 10 x 1025
0049974092	AVX 13 x 1375
0049974092	AVX 13 x 1375 TM
0049975892	AVX 13 x 1475
0049975892	AVX 13 x 1475 TM
0049975992	AVX 13 x 1475
0049975992	AVX 13 x 1475 TM
0049976192	AVX 13 x 1625
0049976192	AVX 13 x 1625 TM
0049976392	AVX 13 x 1425
0049976392	AVX 13 x 1425 TM
0049976992	AVX 13 x 1125



Teilenummer Part number	Abmessung Dimension
----------------------------	------------------------

Teilenummer Part number	Abmessung Dimension
----------------------------	------------------------

Teilenummer Part number	Abmessung Dimension
----------------------------	------------------------

**MERCEDES-BENZ**

0049976992	AVX 13 x 1125 TM
0049977492	AVX 13 x 875
0049977492	AVX 13 x 875 TM
0049977792	AVX 10 x 938
0049977792	AVX 10 x 940
0049977992	AVX 13 x 1350
0049977992	AVX 13 x 1350 TM
0049978092	AVX 10 x 960
0049978492	AVX 13 x 1150
0049978492	AVX 13 x 1150 TM
0049978592	AVX 10 x 1000
0049978792	AVX 10 x 938
0049978792	AVX 10 x 940
0049978892	AVX 13 x 1325
0049978892	AVX 13 x 1325 TM
0049979092	AVX 13 x 1525
0049979092	AVX 13 x 1525 TM
0049979292	AVX 13 x 1425
0049979292	AVX 13 x 1425 TM
0049979392	AVX 13 x 925
0049979392	AVX 13 x 925 TM
0049979492	AVX 13 x 875
0049979492	AVX 13 x 875 TM
0049979592	AVX 13 x 750
0049979592	AVX 13 x 750 TM
0049979892	AVX 13 x 850
0049979992	AVX 13 x 1150
0049979992	AVX 13 x 1150 TM
0059970192	AVX 13 x 875
0059970192	AVX 13 x 875 TM
0059970792	AVX 13 x 750
0059970792	AVX 13 x 750 TM
0059970892	AVX 13 x 900
0059970892	AVX 13 x 900 TM
0059970992	AVX 13 x 925
0059970992	AVX 13 x 925 TM
0059971092	AVX 13 x 950
0059971092	AVX 13 x 950 TM
0059971192	AVX 13 x 950
0059971192	AVX 13 x 950 TM
0059971292	AVX 13 x 1050
0059971292	AVX 13 x 1050 TM
0059971392	AVX 13 x 1100
0059971392	AVX 13 x 1100 TM
0059971492	AVX 13 x 1100
0059971492	AVX 13 x 1100 TM
0059971592	AVX 13 x 1118
0059971692	AVX 13 x 1118
0059971792	AVX 13 x 1125
0059971792	AVX 13 x 1125 TM
0059971892	AVX 13 x 1225
0059971892	AVX 13 x 1225 TM
0059971992	AVX 13 x 1275
0059971992	AVX 13 x 1275 TM
0059972092	AVX 13 x 1350
0059972092	AVX 13 x 1350 TM
0059972292	AVX 13 x 1290
0059972292	AVX 13 x 1300
0059972292	AVX 13 x 1300 TM
0059972392	AVX 13 x 1500
0059972392	AVX 13 x 1500 TM
0059972492	AVX 13 x 1525
0059972792	AVX 13 x 1550
0059972792	AVX 13 x 1550 TM
0059972792	AVX 13 x 1575 TM

**MERCEDES-BENZ**

0059972892	AVX 13 x 1575
0059972892	AVX 13 x 1575 TM
0059973092	AVX 13 x 1700
0059973092	AVX 13 x 1700 TM
0059973692	AVX 13 x 1800
0059973692	AVX 13 x 1800 TM
0059973992	AVX 13 x 1375
0059973992	AVX 13 x 1375 TM
0059974192	AVX 13 x 1750
0059974192	AVX 13 x 1750 TM
0059974292	AVP 13 x 2050 TM
0059974392	AVX 13 x 1325
0059974392	AVX 13 x 1325 TM
0059974492	AVX 13 x 1050
0059974492	AVX 13 x 1050 TM
0059975192	AVX 10 x 1000
0059975292	AVX 13 x 1145
0059975392	AVX 13 x 1000
0059975392	AVX 13 x 1000 TM
0059975692	AVX 10 x 1025
0059975892	AVX 10 x 920
0059976092	AVX 13 x 1175
0059976092	AVX 13 x 1175 TM
0059976292	AVX 13 x 818
0059976692	AVX 10 x 1005
0059976792	AVX 10 x 1005
0059976892	AVX 13 x 1000
0059976892	AVX 13 x 1000 TM
0059976992	AVX 13 x 1025
0059976992	AVX 13 x 1025 TM
0059977092	AVX 13 x 1550
0059977092	AVX 13 x 1550 TM
0059977192	AVX 13 x 1015 TM
0059977692	AVX 13 x 910
0059977792	AVX 10 x 1200
0059977892	AVX 10 x 1140
0059978192	AVX 13 x 835
0059978292	AVX 13 x 875
0059978292	AVX 13 x 875 TM
0059978392	AVX 10 x 875
0059978692	AVX 13 x 1015 TM
0059979192	AVX 13 x 950
0059979192	AVX 13 x 950 TM
0059979292	AVX 10 x 864
0059979592	AVX 10 x 1110
0059979692	AVX 10 x 1050
0059979892	AVX 13 x 1285
0059979992	AVX 13 x 1275
0059979992	AVX 13 x 1275 TM
0069970292	AVX 10 x 913
0069970592	AVX 13 x 975
0069970592	AVX 13 x 975 TM
0069970692	AVX 13 x 1675
0069970692	AVX 13 x 1675 TM
0069970792	AVX 10 x 1005
0069970992	AVX 13 x 750
0069970992	AVX 13 x 750 TM
0069971092	AVX 13 x 1025
0069971092	AVX 13 x 1025 TM
0069971292	AVX 13 x 875
0069971292	AVX 13 x 875 TM
0069971592	AVX 10 x 1150
0069971692	AVX 13 x 1000
0069971692	AVX 13 x 1000 TM
0069971792	AVX 10 x 930

**MERCEDES-BENZ**

0069971892	AVX 10 x 960
0069972092	AVX 13 x 1175
0069972092	AVX 13 x 1175 TM
0069972192	AVX 13 x 1175
0069972192	AVX 13 x 1175 TM
0069972492	AVX 10 x 750
0069972592	AVX 10 x 950
0069972692	AVX 10 x 990
0069972892	AVX 10 x 1225
0069972992	AVX 10 x 838
0069973092	AVX 10 x 980
0069973292	AVX 10 x 935
0069973292	AVX 10 x 938
0069973392	AVX 10 x 1184
0069973492	AVX 10 x 1225
0069973692	AVX 13 x 825
0069973992	AVX 13 x 1125
0069973992	AVX 13 x 1125 TM
0069974392	AVX 13 x 1025
0069974392	AVX 13 x 1025 TM
0069974792	AVX 13 x 1600
0069974792	AVX 13 x 1600 TM
0069974992	AVX 13 x 1125
0069974992	AVX 13 x 1125 TM
0069975092	AVX 13 x 1500
0069975092	AVX 13 x 1500 TM
0069975192	AVX 13 x 1525
0069975292	AVX 13 x 1475
0069975292	AVX 13 x 1475 TM
0069975792	AVX 13 x 1675
0069975792	AVX 13 x 1675 TM
0069976092	AVX 10 x 1100
0069976192	AVX 10 x 1140
0069976292	AVX 13 x 930
0069976392	AVX 13 x 925
0069976392	AVX 13 x 925 TM
0069976892	AVX 13 x 818
0069976992	AVX 13 x 975
0069976992	AVX 13 x 975 TM
0069977092	AVX 13 x 950
0069977092	AVX 13 x 950 TM
0069977192	AVX 13 x 1375
0069977192	AVX 13 x 1375 TM
0069977392	AVX 13 x 1125
0069977392	AVX 13 x 1125 TM
0069977492	AVX 13 x 900
0069977492	AVX 13 x 900 TM
0069977592	AVX 13 x 825
0069977792	AVX 10 x 913
0069977892	AVX 13 x 1350
0069977892	AVX 13 x 1350 TM
0069977992	AVX 10 x 700
0069979092	AVX 13 x 1025
0069979092	AVX 13 x 1025 TM
0069979292	AVX 10 x 975
0069979392	AVX 13 x 1450
0069979392	AVX 13 x 1450 TM
0069979792	AVX 13 x 1025
0069979792	AVX 13 x 1025 TM
0069979992	AVX 13 x 900
0069979992	AVX 13 x 900 TM
007753009501	AVX 10 x 625
007753009502	AVX 10 x 750
007753009504	AVX 10 x 850
007753009507	AVX 10 x 925



Teilenummer Part number	Abmessung Dimension
----------------------------	------------------------

Teilenummer Part number	Abmessung Dimension
----------------------------	------------------------

Teilenummer Part number	Abmessung Dimension
----------------------------	------------------------

**MERCEDES-BENZ****MERCEDES-BENZ****MERCEDES-BENZ**

007753009509	AVX 10 x 975
007753009511	AVX 10 x 1025
007753009535	AVX 10 x 675
007753012500	AVX 13 x 750
007753012500	AVX 13 x 750 TM
007753012502	AVX 13 x 850
007753012503	AVX 13 x 950
007753012503	AVX 13 x 950 TM
007753012504	AVX 13 x 975
007753012504	AVX 13 x 975 TM
007753012505	AVX 13 x 1000
007753012505	AVX 13 x 1000 TM
007753012506	AVX 13 x 1025
007753012506	AVX 13 x 1025 TM
007753012507	AVX 13 x 1050
007753012507	AVX 13 x 1050 TM
007753012508	AVX 13 x 1075
007753012508	AVX 13 x 1075 TM
007753012510	AVX 13 x 1125
007753012510	AVX 13 x 1125 TM
007753012511	AVX 13 x 1200
007753012511	AVX 13 x 1200 TM
007753012512	AVX 13 x 1225
007753012512	AVX 13 x 1225 TM
007753012513	AVX 13 x 1250
007753012513	AVX 13 x 1250 TM
007753012515	AVX 13 x 1325
007753012515	AVX 13 x 1325 TM
007753012516	AVX 13 x 1350
007753012516	AVX 13 x 1350 TM
007753012517	AVX 13 x 1400
007753012517	AVX 13 x 1400 TM
007753012519	AVX 13 x 1425
007753012519	AVX 13 x 1425 TM
007753012520	AVX 13 x 1450
007753012520	AVX 13 x 1450 TM
007753012521	AVX 13 x 1475
007753012521	AVX 13 x 1475 TM
007753012523	AVX 13 x 1500
007753012523	AVX 13 x 1500 TM
007753012524	AVX 13 x 1550
007753012524	AVX 13 x 1550 TM
007753012525	AVX 13 x 1600
007753012525	AVX 13 x 1600 TM
007753012529	AVX 13 x 1700
007753012529	AVX 13 x 1700 TM
007753012530	AVX 13 x 1750
007753012530	AVX 13 x 1750 TM
007753012531	AVX 13 x 1800
007753012531	AVX 13 x 1800 TM
007753012533	AVX 13 x 1900
007753012533	AVX 13 x 1900 TM
007753012539	AVX 13 x 1175
007753012539	AVX 13 x 1175 TM
007753012540	AVX 13 x 1250
007753012540	AVX 13 x 1250 TM
007753012540	AVX 13 x 1275 TM
007753012550	AVX 13 x 1375
007753012550	AVX 13 x 1375 TM
007753012558	AVX 13 x 825
007753012559	AVX 13 x 875
007753012559	AVX 13 x 875 TM
007753012561	AVX 13 x 900
007753012561	AVX 13 x 900 TM
007753012567	AVX 13 x 1150

007753012567	AVX 13 x 1150 TM
007753012573	AVX 13 x 1725
007753112501	AVX 13 x 1750
007753112501	AVX 13 x 1750 TM
007753112504	AVX 13 x 1475
007753112504	AVX 13 x 1475 TM
007753112527	AVX 13 x 1375
007753112527	AVX 13 x 1375 TM
0079970192	AVX 13 x 1625
0079970192	AVX 13 x 1625 TM
0079970292	AVX 13 x 1825 TM
0079970392	AVX 13 x 1025
0079970392	AVX 13 x 1025 TM
0079970792	AVX 13 x 1825
0079970792	AVX 13 x 1825 TM
0079970892	AVX 13 x 1050
0079970892	AVX 13 x 1050 TM
0079971092	AVX 13 x 1450
0079971092	AVX 13 x 1450 TM
0079971492	AVX 10 x 913
0079971692	AVX 13 x 1025 TM
0079971892	AVX 10 x 975
0079972292	AVX 13 x 1300
0079972292	AVX 13 x 1300 TM
0079972692	AVX 10 x 975
0079972792	AVX 13 x 1575
0079972792	AVX 13 x 1575 TM
0079973192	AVX 13 x 1375
0079973192	AVX 13 x 1375 TM
0079973892	AVX 13 x 1800
0079973892	AVX 13 x 1800 TM
0079974592	AVX 13 x 1575
0079974592	AVX 13 x 1575 TM
0079974692	AVX 13 x 1625
0079974692	AVX 13 x 1625 TM
0079974792	AVX 13 x 1675
0079974792	AVX 13 x 1675 TM
0079974992	AVX 13 x 1100
0079974992	AVX 13 x 1100 TM
0079975092	AVX 13 x 1100
0079975092	AVX 13 x 1100 TM
0079975192	AVX 13 x 1125
0079975192	AVX 13 x 1125 TM
0079975292	AVX 13 x 1150
0079975292	AVX 13 x 1150 TM
0079975492	AVX 13 x 1175
0079975492	AVX 13 x 1175 TM
0079976492	AVX 13 x 1950
0079976492	AVX 13 x 1950 TM
0079976592	AVP 13 x 1950 TM
0079976592	AVX 13 x 1950 TM
0079976892	AVX 13 x 1235
0079977892	AVX 10 x 900
0079978092	6 PK 1980
0079978192	6 PK 2330
0079978292	6 PK 2245
0079978492	6 PK 2120
0079978892	6 PK 1840
0079979092	6 PK 1015
0079979092	6 PK 1015 TM
0079979492	6 PK 1015
0079979492	6 PK 1015 TM
0080329030	AVX 13 x 1225
0080329030	AVX 13 x 1225 TM
0089970092	AVX 13 x 1375

0089970092	AVX 13 x 1375 TM
0089970192	6 PK 2030
0089970492	AVX 13 x 1475
0089970492	AVX 13 x 1475 TM
0089970592	AVX 13 x 1950
0089970592	AVX 13 x 1950 TM
0089970992	6 PK 2100
0089971092	6 PK 2460
0089971792	6 PK 2176
0089971892	6 PK 2260
0089971992	6 PK 2465
0089972192	6 PK 2080
0089972292	6 PK 2145
0089972692	6 PK 2100
0089973292	6 PK 1015
0089973292	6 PK 1015 TM
0089973392	6 PK 2055
0089973492	6 PK 2120
0089973492	6 PK 2120 TM
0089973592	6 PK 2030
0089973692	6 PK 2100
0089973792	6 PK 2080
0089973892	6 PK 2145
0089974492	6 PK 1885
0089974592	6 PK 1980
0089974892	AVX 13 x 960
0089976392	6 PK 2020
0089976692	AVX 13 x 700
0089976992	6 PK 2176
0089977092	6 PK 2257
0089977092	6 PK 2260
0089977192	6 PK 1015
0089977192	6 PK 1015 TM
0089977292	6 PK 1885
0089977392	6 PK 1980
0089977692	AVX 13 x 1075
0089977692	AVX 13 x 1075 TM
0089977792	9 PK 4100 TM
0089978792	6 PK 2205
0089978892	6 PK 2285
0089979092	6 PK 2000
0089979192	6 PK 1885
0089979292	6 PK 2055
0089979392	6 PK 2050
0089979892	AVX 13 x 1425
0089979892	AVX 13 x 1425 TM
0099970292	AVX 10 x 990
0099970392	AVX 10 x 1005
0099971492	6 PK 1950
0099971692	6 PK 2415
0099971792	6 PK 2360
0099971892	6 PK 2445
0099972892	6 PK 2030
0099974092	6 PK 1185
0099974392	AVX 13 x 1475
0099974392	AVX 13 x 1475 TM
0099974692	AVX 13 x 1600
0099974692	AVX 13 x 1600 TM
0099974792	AVX 13 x 1015 TM
0099974892	AVX 13 x 1015 TM
0099975297	AVX 10 x 990
009997532	AVX 10 x 1005
0099975392	AVX 10 x 1005
0099975492	6 PK 2176
0099975892	6 PK 2460



Teilenummer Part number	Abmessung Dimension
----------------------------	------------------------

Teilenummer Part number	Abmessung Dimension
----------------------------	------------------------

Teilenummer Part number	Abmessung Dimension
----------------------------	------------------------

**MERCEDES-BENZ**

0099975992	AVX 13 x 1675
0099975992	AVX 13 x 1675 TM
0099976092	8 PK 2465
0099976092	8 PK 2585 TM
0099976292	AVX 13 x 1350
0099976292	AVX 13 x 1350 TM
0099976392	AVX 13 x 1375
0099976392	AVX 13 x 1375 TM
0099976492	AVX 13 x 1400
0099976492	AVX 13 x 1400 TM
0099976592	2/AVX 13 x 1350
0099976592	AVX 13 x 1350
0099976592	AVX 13 x 1350 TM
0099976692	AVX 13 x 1375
0099976692	AVX 13 x 1375 TM
0099976792	AVX 13 x 1400
0099976792	AVX 13 x 1400 TM
0099976892	AVX 13 x 1025
0099976892	AVX 13 x 1025 TM
0099976992	AVX 13 x 1025 TM
0099977092	AVX 13 x 1050
0099977092	AVX 13 x 1050 TM
0099977192	2/AVX 13 x 1050
0099977192	AVX 13 x 1050
0099977192	AVX 13 x 1050 TM
0099977592	AVX 13 x 1300
0099977592	AVX 13 x 1300 TM
0099977692	AVX 13 x 1300
0099977692	AVX 13 x 1300 TM
0099977792	AVX 13 x 1325
0099977792	AVX 13 x 1325 TM
0099977892	AVX 13 x 1325
0099977892	AVX 13 x 1325 TM
0099977992	6 PK 2465
0099978592	8 PK 2465
0099978692	8 PK 2465
0099978792	8 PK 2465
0099979192	6 PK 2155
0099979492	6 PK 1950
0099979592	8 PK 2337
0099979692	8 PK 2440
0107561	AVX 13 x 1350
0107561	AVX 13 x 1350 TM
0109970592	6 PK 2040
0109970692	6 PK 2140
0109970992	9 PK 4145 TM
0109971192	8 PK 2523 TM
0109971692	7 PK 1385
0109972092	AVX 13 x 1025
0109972092	AVX 13 x 1025 TM
0109972692	AVP 13 x 2450 TM
0109972992	8 PK 2380 TM
0109973392	AVX 13 x 1085
0109973792	AVX 13 x 1450
0109973792	AVX 13 x 1450 TM
0109973892	AVX 13 x 1175
0109973892	AVX 13 x 1175 TM
0109974392	6 PK 2535
0109974592	6 PK 2535
0109974692	8 PK 2585 TM
0109974892	6 PK 2080
0109974992	AVX 13 x 1025
0109974992	AVX 13 x 1025 TM
0109975292	AVX 13 x 1350
0109975292	AVX 13 x 1350 TM

**MERCEDES-BENZ**

0109975792	6 PK 2330
0109975892	6 PK 2415
0109975992	6 PK 2176
0109976292	6 PK 2050
0109976392	6 PK 2445
0109976592	3-SPB 2100 TM
0109977092	6 PK 2050
0109977092	6 PK 2055
0109977192	6 PK 2040
0109977292	6 PK 2330
0109977392	8 PK 2585 TM
0109977492	6 PK 2535
0109977892	6 PK 2535
0109977992	6 PK 2140
0109978092	6 PK 2080
0109978192	6 PK 2415
0109978192	6 PK 2415 TM
0109978292	6 PK 2176
0109978392	6 PK 2445
0109978492	6 PK 2460
0109978592	8 PK 2523 TM
0109978692	6 PK 2140
0109978792	6 PK 2245
0109978892	6 PK 2228
0109978992	6 PK 2475
0109979192	6 PK 2191
0109979292	6 PK 2445
0109979892	6 PK 2585
0119970092	2 PJ 860
0119970192	6 PK 1775
0119970292	6 PK 1870
0119970492	6 PK 2330
0119970592	6 PK 2415
0119970692	6 PK 2445
0119970892	6 PK 2510
0119970992	6 PK 2510
0119971492	6 PK 2080
0119971592	6 PK 2100
0119971692	6 PK 2120 TM
0119971792	6 PK 2140
0119971892	6 PK 2055
0119971992	6 PK 2155
0119972092	6 PK 2100
0119972192	6 PK 2205
0119972892	6 PK 2145
0119972992	6 PK 2535
0119973092	6 PK 2460
0119973192	AVX 13 x 975
0119973192	AVX 13 x 975 TM
0119973392	6 PK 1330
0119973492	6 PK 2380
0119973692	6 PK 1760
0119973792	6 PK 1863
0119973892	6 PK 2130
0119974292	6 PK 2040
0119974592	6 PK 2510
0119974792	6 PK 2415
0119974892	6 PK 2115
0119974992	6 PK 2215
0119975292	6 PK 2155
0119975392	6 PK 2000
0119975492	6 PK 2040
0119975592	6 PK 2205
0119975692	6 PK 2030
0119975892	6 PK 1330

**MERCEDES-BENZ**

0119976392	8 PK 2337
0119976492	8 PK 2440
0119976592	6 PK 2245
0119976792	6 PK 2585
0119976892	6 PK 2535
0119976992	7 PK 1290
0119977192	7 DPK 1360
0119978092	6 PK 2120
0119978292	6 PK 2360
0119978492	6 PK 2065
0119978592	6 PK 2120
0119978692	6 PK 2315
0119978792	6 PK 2390
0119979192	5 PK 1290
0119979292	5 PK 1750
0119979392	5 PK 1290
0119979492	5 PK 1750
0119979692	6 PK 2315
0119979742	6 PK 2390
0119979792	6 PK 2390
0129970092	5 PK 1270
0129970192	5 PK 1720
0129970592	6 PK 2191
0129970692	6 PK 2160
0129970792	6 PK 2270
0129970892	6 PK 2240
0129970992	6 PK 2205
0129971092	6 PK 2285
0129971192	6 PK 2285
0129971592	6 PK 2055
0129971892	AVX 10 x 1225
0129971892	AVX 10 x 1400
0129972092	9 PK 2125 TM
0129972192	11 PK 2055 TM
0129972992	6 PK 2345
0129973592	6 PK 2315
0129973692	6 PK 2390
0129974292	6 PK 2075
0129974392	6 PK 2160
0129974592	6 PK 1205
0129974792	6 PK 2191
0129974892	6 PK 2260
0129975092	6 PK 2270
0129975192	6 PK 2315
0129975492	6 PK 1352
0129975592	6 PK 1352
0129975892	6 PK 2030
0129975992	6 PK 1775
0129976092	9 PK 1725 TM
0129976192	9 PK 1610 TM
0129976392	11 PK 2040 TM
0129976492	11 PK 2020 TM
0129977092	6 PK 2390
0129977492	5 PK 1270
0129977592	5 PK 1720
0129977692	5 PK 1290
0129977792	5 PK 1750
0129978492	AVX 13 x 875
0129978492	AVX 13 x 875 TM
0129979392	AVX 13 x 1200
0129979392	AVX 13 x 1200 TM
0129979592	AVX 13 x 1325
0129979592	AVX 13 x 1325 TM
0129979792	AVX 13 x 1150
0129979792	AVX 13 x 1150 TM





Teilenummer Part number	Abmessung Dimension
----------------------------	------------------------

Teilenummer Part number	Abmessung Dimension
----------------------------	------------------------

Teilenummer Part number	Abmessung Dimension
----------------------------	------------------------

**MERCEDES-BENZ**

0139970392	AVX 13 x 1150
0139970392	AVX 13 x 1150 TM
0139970492	AVX 13 x 1400
0139970492	AVX 13 x 1400 TM
0139970692	AVX 13 x 1000
0139970692	AVX 13 x 1000 TM
0139970792	AVX 13 x 1250
0139970792	AVX 13 x 1250 TM
0139970892	AVX 13 x 1300
0139970892	AVX 13 x 1300 TM
0139970992	AVX 13 x 950
0139970992	AVX 13 x 950 TM
0139971192	6 PK 2191
0139971292	AVX 13 x 1225
0139971292	AVX 13 x 1225 TM
0139971492	5 PK 1290
0139971592	5 PK 1750
0139971692	10 PK 1005 TM
0139971792	9 PK 2010 TM
0139972292	6 PK 2191
0139972392	6 PK 2260
0139972592	6 PK 2075
0139972692	6 PK 2160
0139972992	10 PK 1845 TM
0139973092	11 PK 2020 TM
0139973192	10 PK 1860 TM
0139973292	AVX 13 x 1275
0139973292	AVX 13 x 1275 TM
0139973792	AVX 13 x 950
0139973792	AVX 13 x 950 TM
0139974092	6 PK 2020
0139974192	6 PK 2130
0139974392	9 PK 1888 TM
0139974492	7 PK 2283
0139974592	6 PK 2140
0139974692	6 PK 1870
0139974792	6 PK 1870
0139974892	6 PK 1863
0139975092	7 PK 2276
0139975792	9 PK 1920 TM
0139976192	9 PK 2060 TM
0139977392	7 PK 2315
0139977492	7 PK 2415
0139978092	AVX 13 x 1050
0139978092	AVX 13 x 1050 TM
0139978192	AVX 13 x 1350
0139978192	AVX 13 x 1350 TM
0139978292	AVX 13 x 950
0139978292	AVX 13 x 950 TM
0139978292	AVX 13 x 960
0139978692	AVX 13 x 1725
0139978792	6 PK 2373
0139979092	AVX 13 x 1000
0139979092	AVX 13 x 1000 TM
0139979292	AVX 13 x 1675
0139979292	AVX 13 x 1675 TM
0139979392	AVX 13 x 1625
0139979392	AVX 13 x 1625 TM
0139979492	AVX 13 x 900
0139979492	AVX 13 x 900 TM
0139979592	AVX 13 x 1600
0139979592	AVX 13 x 1600 TM
0139979692	AVX 13 x 925
0139979692	AVX 13 x 925 TM
0139979792	AVX 13 x 1575

**MERCEDES-BENZ**

0139979792	AVX 13 x 1575 TM
0149970292	AVX 13 x 975
0149970292	AVX 13 x 975 TM
0149970492	6 PK 2270
0149970692	6 PK 2260
0149970792	6 PK 2260
0149970892	6 PK 2075
0149970992	6 PK 2191
0149971092	6 PK 2240
0149971092	6 PK 2245
014997109264	6 PK 2245
0149971192	6 PK 2160
0149971292	6 PK 2160
0149971392	5 PK 1260
0149971492	5 PK 1715
0149971592	7 PK 2276
0149971692	7 PK 2283
0149971792	6 PK 2260
0149973292	5 PK 1290
0149973392	5 PK 1750
0149973792	7 PK 2337
0149974592	9 PK 1725 TM
0149975292	12 PK 1400 TM
0149976092	9 PK 2100 TM
0149976892	9 PK 2295 TM
0149977192	6 PK 2380
0149977392	9 PK 1888 TM
0149977792	7 PK 2276
0149977892	8 PK 1610 TM
0159970092	6 PK 2228
0159970292	6 PK 2255
0159970392	7 PK 2276
0159971192	9 PK 1610 TM
0159971792	9 PK 2010 TM
0159972092	9 PK 2060 TM
0159972192	9 PK 1780 TM
0159972592	6 PK 2404
0159973292	8 PK 1610 TM
0159973792	9 PK 2295 TM
0159974792	5 PK 1300
0159974892	5 PK 1765
019975092	AVX 13 x 1400
019975092	AVX 13 x 1400 TM
0199977492	7 PK 2415
057903137H	6 PK 1625
07753012574	AVX 13 x 725
079970892	AVX 13 x 1050
079970892	AVX 13 x 1050 TM
1022006970	410SR
1029970092	6 PK 1885
1029977292	6 PK 1885
1032000570	402SR
1032000870	411SR
1042000470	405SR
1139970092	6 PK 2460
1139970292	6 PK 2445
1159970392	6 PK 2415
1192000370	406SR
1192000470	407UR
1192001470	414UR
1199972292	6 PK 1840
1202000470	404SR
125X1000	AVX 13 x 1000
125X1000	AVX 13 x 1000 TM
125X1000N27	AVX 13 x 1000

**MERCEDES-BENZ**

125X1000N27	AVX 13 x 1000 TM
125X1025N27	AVX 13 x 1025
125X1025N27	AVX 13 x 1025 TM
125X1275N27	AVX 13 x 1275
125X1275N27	AVX 13 x 1275 TM
125X1300N27	AVX 13 x 1300
125X1300N27	AVX 13 x 1300 TM
125X1450N27	AVX 13 x 1450
125X1450N27	AVX 13 x 1450 TM
125X1475N27	AVX 13 x 1475
125X1475N27	AVX 13 x 1475 TM
125X1500N27	AVX 13 x 1500
125X1500N27	AVX 13 x 1500 TM
125X1600N27	AVX 13 x 1600
125X1600N27	AVX 13 x 1600 TM
129975892	6 PK 2030
1559970392	6 PK 2415
1669973092	7 PK 2337
19937596	7 PK 2035
2203557/5	6 PK 2080
308392	AVX 10 x 1050
3459977192	AVX 13 x 1150
3459977192	AVX 13 x 1150 TM
3459977292	AVX 13 x 1750
3459977292	AVX 13 x 1750 TM
3739977292	2-SPB 2100 TM
4379970292	AVX 13 x 1350
4379970292	AVX 13 x 1350 TM
4422000770	409SR
4768010000	9 PK 4145 TM
4768010000	9 PK 4145 TM
4768017000	9 PK 4100 TM
47680170000	9 PK 4100 TM
5412001070	KT 7004
5412001870	KT 7004
5419970192	9 PK 2125 TM
5419970892	9 PK 1888 TM
5419970992	9 PK 2835 TM
5419970992	KT 7004
5419971092	9 PK 2295 TM
5419972592	12 PK 1515 TM
5419972692	11 PK 1890 TM
5419972792	11 PK 2835 TM
5419972892	8 PK 1215 TM
5419973092	12 PK 1507 TM
5429970392	9 PK 2871 TM
6012000770	401UR
6012000970	400SR
6012001070	403UR
6019810027	413UR
6019970292	6 PK 2055
6019970592	6 PK 995
6129970092	6 PK 2255
6139930195	3-SPB 2100 TM
6429970292	7 PK 2035
69973292	AVX 10 x 935
9062000570	460SR
9062001570	460SR
9062001870	460SR
9069931596	8 PK 1688 TM
9069931696	8 PK 1215 TM
9069932296	8 PK 2080 TM
9069932696	10 PK 1400 TM
9069932896	10 PK 1240 TM
9069933396	8 PK 1940 TM

Teilenummer Part number	Abmessung Dimension
----------------------------	------------------------

Teilenummer Part number	Abmessung Dimension
----------------------------	------------------------

Teilenummer Part number	Abmessung Dimension
----------------------------	------------------------

**MERCEDES-BENZ**

9069933696	8 PK 1985 TM
9069933996	8 PK 1365 TM
9069934096	8 PK 1940 TM
9069934196	8 PK 1915 TM
9069934496	8 PK 1175
9069934596	8 PK 1190 TM
9069934996	8 PK 1190 TM
9069936296	8 PK 1190 TM
9069936596	10 PK 1670 TM
9069936696	10 PK 1815 TM
9069936796	8 PK 1635 TM
9069936896	8 PK 1688 TM
9069937096	8 PK 1850 TM
9069937196	8 PK 1420 TM
9069937296	8 PK 2523 TM
9069937496	8 PK 1956 TM
9069937996	8 PK 1376 TM
9069937996	KT 7005
9069938996	8 PK 1795 TM
9069970792	8 PK 1480 TM
9069970992	8 PK 2605 TM
9069971192	8 PK 2080 TM
9069971292	8 PK 2000 TM
9069971392	8 PK 1190 TM
9069971492	8 PK 1175
9069971992	8 PK 1956 TM
9069972192	10 PK 1768 TM
9069972392	8 PK 2045 TM
9069972492	8 PK 1420 TM
9069972692	10 PK 1350 TM
9069972892	8 PK 1910 TM
9069972892	8 PK 1915 TM
9069972992	8 PK 2523 TM
9069973192	8 PK 1850 TM
9069973292	8 PK 1985 TM
9069973392	10 PK 1240 TM
9069973592	8 PK 1940 TM
9069973692	8 PK 2560 TM
9069973892	10 PK 2240 TM
9069974092	10 PK 1620 TM
9069974492	8 PK 1220 TM
9069974592	10 PK 1400 TM
9069974692	10 PK 1670 TM
9069974792	10 PK 1815 TM
A0009932096	5 PK 1745
A0019933096	5 PK 1745
A0019933896	6 EPK 691
A0019933996	6 EPK 691
A0019937696	3 EPK 806
A0019937796	5 PK 1745
A0029932496	8 PK 1215 TM
A0029970892	AVX 10 x 935
A0069973292	AVX 10 x 935
A0109970992	9 PK 4145 TM
A0109972692	AVP 13 x 2450 TM
A0109976592	3-SPB 2100 TM
A0119975692	6 PK 2030
A47680100000	9 PK 4145 TM
A47680170000	9 PK 4100 TM
A9069937496	8 PK 1956 TM
A9069971992	8 PK 1956 TM
A9069972892	8 PK 1910 TM
BMK1020	AVX 13 x 1375
BMK1020	AVX 13 x 1375 TM

**MERCURY**

0009977492	AVX 13 x 1600
0009977492	AVX 13 x 1600 TM

**MG**

13H924	AVX 10 x 938
1H1001	AVX 10 x 900
ADU6528	AVX 10 x 938
AEA489	AVX 10 x 900
AHU2174	4 PK 890
CDU2160	3 PK 750
GCB10937	AVX 10 x 938
GFB123	AVX 13 x 1100 TM
GFB128	AVX 13 x 1075 TM
GFB189	AVX 13 x 1075
GFB189	AVX 13 x 1075 TM
GFB21075	AVX 13 x 1075 TM
GFB243	AVX 13 x 1075 TM
GFB272	AVX 10 x 938
GFB60937	AVX 10 x 938
GFB701	AVX 10 x 938
GFB80890	4 PK 890
GFB90890	5 PK 890
GMB40890	4 PK 890
GMB50735	5 PK 735
GMB51202	5 PK 1200
GTB1497XS	ZRK 1749
GTB9000	ZRK 1350
LHN100410	ZRK 1350
LHN100560	ZRK 1749
PQS100850	6 PK 1460
PQS100940	5 PK 1145
PQS101030	6 PK 1185
PQS101180	5 PK 1200
PQS101261	6 PK 1285
PQS101262	6 PK 1285
PQS101271	6 PK 1560
PQS101272	6 PK 1560
PQS101300	5 PK 2030
PQS101310	5 PK 870
PQS101450	3 PK 740
PSQ100840	5 PK 735
PSQ101590	5 PK 1165
TKC2808	AVX 10 x 938

**MINI**

11280300802	6 PK 1375
11281497435	6 PK 1055
11281505672	6 PK 894
11287509992	6 PK 1035
11287518249	6 PK 894
11287518250	6 PK 1035
11287518251	6 PK 1055
11287520199	6 PK 1390
11287526363	6 PK 894
11287526364	6 PK 1055
11287534703	6 PK 870
11287545120	6 PK 1375
11287566789	6 PK 906
11287571377	6 PK 906
11287790919	3 EPK 885
11287791336	7 PK 1175
11287791337	7 PK 935
11287795036	6 PK 800
11287798112	6 PK 975
11287801391	7 PK 1175

**MINI**

11287801393	7 PK 935
11317805957	ZRK 1460
7790919	3 EPK 885
7805957	ZRK 1460
9682237080	6 PK 800

**MINI**

030768	AVX 10 x 864
1340A004	6 PK 1890
1340A035	5 PK 1790
1340A052	6 PK 1190
1340A058	4 PK 875
1340A065	4 PK 763
1340A066	4 PK 780
1340A078	5 PK 1190
1340A113	5 PK 1190
14451A023	4 PK 805
2335633160	ZRK 1459
30621589	KT 1434
4451A020	6 PK 1718
4451A023	4 PK 805
4451A058	4 PK 985
4451A059	6 PK 1718
4451A108	6 PK 1718
7700108148	5 PK 1125
7700109477	6 PK 1795
7700109601	ZRK 1067
7700865429	6 PK 1138
AY1404154M	4 PK 1540
M343741	602ST
M616942	5 PK 1125
M809320	6 PK 1138
M819189	6 PK 1642
M819383	ZRK 1146
M855992	603UT
M855993	602ST
M864046	ZRK 1195
M864049	631UT
M883810	ZRK 1067
M883832	6 PK 1795
MB076213	AVX 13 x 750
MB076629	AVX 13 x 625
MB166386	AVX 13 x 785
MB166411	AVX 13 x 750
MB167065	AVX 13 x 900
MB167069	AVX 13 x 1000
MB167069	AVX 13 x 1000 TM
MB182294	ZRK 1180
MB266253	AVX 13 x 1015
MB266253	AVX 13 x 1015 TM
MB272653	AVX 13 x 950
MB332253	AVX 13 x 800
MB332253	AVX 13 x 800 TM
MB439336	4 PK 920
MB439494	4 PK 925
MB439714	4 PK 913
MB501593	AVX 13 x 625
MB553391	AVX 13 x 625
MB553429	AVX 13 x 625
MB553430	AVX 13 x 800
MB553431	AVX 13 x 625
MB553792	AVX 13 x 975
MB568898	4 PK 940
MB568899	4 PK 950
MB657285	4 PK 995



Teilenummer Part number	Abmessung Dimension
----------------------------	------------------------

Teilenummer Part number	Abmessung Dimension
----------------------------	------------------------

Teilenummer Part number	Abmessung Dimension
----------------------------	------------------------

**MITSUBISHI**

MB813251	5 PK 1125
MB813272	5 PK 1110
MB813382	AVX 13 x 950
MB813600	6 PK 1145
MB813806	5 PK 880
MB813867	5 PK 1145
MB831600	6 PK 1145
MB879764	6 PK 1145
MB897764	6 PK 1145
MB917985	5 PK 1110
MB917986	5 PK 860
MB918384	5 PK 1040
MB946603	5 PK 1060
MB958695	5 PK 1240
MB958696	4 PK 940
MD0021663	AVX 10 x 935
MD005350	AVX 10 x 813
MD005351	AVX 10 x 813
MD007528	AVX 10 x 925
MD007528	AVX 10 x 935
MD007528	AVX 10 x 938
MD007628	AVX 10 x 935
MD007628	AVX 10 x 938
MD008965	928ST
MD008968	ZRK 1213
MD009060	AVX 10 x 935
MD009060	AVX 10 x 938
MD009352	ZRK 1213
MD009650	397UT
MD011351	AVX 10 x 864
MD011536	192ST
MD012587	191UT
MD013805	ZRK 1258
MD015310	ZRK 1258
MD015311	ZRK 1388
MD015701	ZRK 1259
MD021458	AVX 13 x 925
MD021663	AVX 10 x 938
MD025522	AVX 13 x 950
MD025522	AVX 13 x 950 TM
MD025523	AVX 10 x 960
MD025523	AVX 10 x 965
MD025826	AVX 10 x 935
MD025826	AVX 10 x 938
MD026572	AVX 10 x 935
MD026572	AVX 10 x 938
MD027458	AVX 10 x 935
MD027458	AVX 10 x 938
MD030599	ZRK 1036
MD030600	ZRK 1036
MD030605	925ST
MD030768	AVX 10 x 864
MD040754	931UT
MD041390	ZRK 1259
MD041407	ZRK 1388
MD041704	AVX 10 x 975
MD050119	ZRK 1277
MD050125	929ST
MD050130	ZRK 1260
MD050135	927ST
MD050175	ZRK 1277
MD060461	ZRK 1260
MD068173	ZRK 1285
MD069671	4 PK 870
MD069672	4 PK 940

**MITSUBISHI**

MD070584	AVX 13 x 1000
MD071350	AVX 13 x 1000
MD074251	4 PK 980
MD076231	AVX 13 x 750
MD095193	AVX 13 x 1000
MD095866	ZRK 1258
MD098491	ZRK 1259
MD098492	ZRK 1285
MD099706	ZRK 1036
MD099707	ZRK 1260
MD101800	5 PK 1240
MD102248	ZRK 1258
MD102249	ZRK 1259
MD104578	194ST
MD106103	ZRK 1388
MD106658	4 PK 870
MD109958	926ST
MD110029	ZRK 1329
MD110709	ZRK 1285
MD111147	4 PK 980
MD111427	ZRK 1192
MD113562	ZRK 1213
MD113563	ZRK 1036
MD113564	ZRK 1017
MD115677	5 PK 1015
MD115976	850UT
MD115977	ZRK 1459
MD116786	ZRK 1017
MD117356	4 PK 875
MD117358	4 PK 875
MD118572	4 PK 875
MD118716	6 PK 1635
MD120487	ZRK 1175
MD120557	AVX 13 x 1025
MD122602	4 PK 985
MD128765	330UT
MD130766	4 PK 985
MD132479	4 PK 985
MD133115	ZRK 1329
MD133116	ZRK 1193
MD134377	ZRK 1260
MD134958	5 PK 1240
MD134959	6 PK 1635
MD137245	5 PK 1330
MD137594	4 PK 995
MD140227	ZRK 1175
MD140228	ZRK 1259
MD140229	ZRK 1285
MD142117	5 PK 1345
MD144817	4 PK 985
MD145713	ZRK 1329
MD145716	ZRK 1459
MD145813	ZRK 1156
MD146186	930ST
MD152622	ZRK 1277
MD156604	189UT
MD163032	4 PK 780
MD165995	6 PK 1070
MD166385	AVX 10 x 1000
MD169592	237UT
MD171373	4 PK 780
MD171748	ZRK 1329
MD171749	ZRK 1459
MD172376	4 PK 920
MD172544	5 PK 950

**MITSUBISHI**

MD173201	4 PK 920
MD173536	3 PK 763
MD174352	190ST
MD175375	199ST
MD176386	ZRK 1207
MD176387	ZRK 1208
MD179620	ZRK 1435
MD179679	4 PK 920
MD180106	5 PK 925
MD180574	4 PK 763
MD182201	ZRK 1193
MD182291	ZRK 1329
MD182292	ZRK 1541
MD182293	ZRK 1176
MD182294	ZRK 1180
MD182295	ZRK 1459
MD182537	188UT
MD183556	4 PK 763
MD184973	4 PK 950
MD185963	AVX 13 x 975
MD185964	AVX 13 x 785
MD186111	4 PK 635
MD186123	4 PK 980
MD186124	4 PK 980
MD186125	4 PK 985
MD186126	4 PK 995
MD187461	5 PK 1240
MD187462	5 PK 1345
MD187463	6 PK 1070
MD188026	5 PK 950
MD188826	4 PK 1125
MD189130	4 PK 698
MD189521	ZRK 1174
MD189522	ZRK 1177
MD191218	4 PK 940
MD191982	ZRK 1437
MD192068	166UT
MD192295	ZRK 1459
MD192731	189UT
MD192808	4 PK 763
MD192809	5 PK 950
MD197122	ZRK 1061
MD197142	ZRK 1329
MD197153	ZRK 1522
MD197722	5 PK 925
MD198169	AVX 13 x 1025
MD199223	5 PK 1130
MD199224	4 PK 1065
MD199418	ZRK 1193
MD199826	4 PK 1125
MD300470	ZRK 1522
MD300473	ZRK 1202
MD300587	4 PK 698
MD301833	4 PK 775
MD303031	4 PK 900
MD303375	ZRK 1211
MD304887	5 PK 1345
MD307487	ZRK 1430
MD308925	4 PK 954
MD310014	4 PK 1060
MD310371	5 PK 1040
MD310484	ZRK 1202
MD310616	4 PK 985
MD310617	4 PK 698
MD310836	ZRK 1437



Teilenummer Part number	Abmessung Dimension	Teilenummer Part number	Abmessung Dimension	Teilenummer Part number	Abmessung Dimension
<b>MITSUBISHI</b>		<b>MITSUBISHI</b>		<b>MITSUBISHI</b>	
MD311554	5 PK 954	MD363023	4 PK 1005	XD134377	ZRK 1260
MD311704	4 PK 1080	MD363460	5 PK 962	XD140227	ZRK 1175
MD312400	4 PK 775	MD366357	5 PK 865	XD140228	ZRK 1259
MD3130370	5 PK 985	MD366490	7 PK 2415	XD140229	ZRK 1285
MD314456	ZRK 1405	MD368858	4 PK 1125	XD145813	ZRK 1156
MD314778	4 PK 595	MD369862	6 PK 1370	XD179620	ZRK 1435
MD315265	199ST	MD373620	5 PK 865	XD182291	ZRK 1329
MD316140	5 PK 1130	MD373622	5 PK 1300	XD182293	ZRK 1176
MD317142	6 PK 1060	MD375935	5 PK 1060	XD182294	ZRK 1180
MD317245	5 PK 1330	MD377381	6 PK 1440	XD191982	ZRK 1437
MD317528	5 PK 1080	MD553429	AVX 13 x 625	XD307487	ZRK 1430
MD317529	5 PK 1330	MD568898	4 PK 940	XD314456	ZRK 1405
MD317871	ZRK 1430	MD865078	631UT	XD319023	ZRK 1211
MD318667	6 PK 1070	MD883811	346ST	XD322641	ZRK 1409
MD318874	6 PK 1205	ME900247	AVX 13 x 1275	XD326059	ZRK 1329
MD319023	ZRK 1211	ME900247	AVX 13 x 1275 TM	XD329639	ZRK 1065
MD319917	5 PK 1080	ME900249	AVX 13 x 1275	XD331076	ZRK 1541
MD320174	339ST	ME900249	AVX 13 x 1275 TM		
MD322330	4 PK 900	ME902206	AVX 13 x 1200	<b>MORRIS</b>	
MD322641	ZRK 1409	ME902206	AVX 13 x 1200 TM	13H924	AVX 10 x 938
MD323573	6 PK 1205	ME909202	AVX 13 x 800	ADU6528	AVX 10 x 938
MD325262	5 PK 975	ME909202	AVX 13 x 800 TM	GCB10937	AVX 10 x 938
MD325599	5 PK 1060	MH014093	AVX 13 x 1175	GFB123	AVX 13 x 1100 TM
MD325600	5 PK 870	MH014093	AVX 13 x 1175 TM	GFB128	AVX 13 x 1075 TM
MD325854	ZRK 1203	MH014378	AVX 13 x 1200	GFB189	AVX 13 x 1075 TM
MD326025	ZRK 1329	MH014378	AVX 13 x 1200 TM	GFB21075	AVX 13 x 1075 TM
MD326059	ZRK 1329	MH014379	AVX 13 x 1200	GFB243	AVX 13 x 1075 TM
MD326780	4 PK 940	MH014379	AVX 13 x 1200 TM	GFB272	AVX 10 x 938
MD326781	5 PK 1390	MN128695	6 PK 1830	GFB60937	AVX 10 x 938
MD326782	5 PK 1090	MN155725	7 PK 2415	GFB701	AVX 10 x 938
MD329625	927ST	MN155726	4 PK 970	TKC2802	AVX 10 x 938
MD329639	ZRK 1065	MN155728	5 PK 1130		
MD331076	ZRK 1541	MN158794	6 PK 1795	<b>MOSKVICH</b>	
MD331884	5 PK 1300	MN158795	6 PK 1445	2101-1308020	AVX 10 x 938
MD334464	4 PK 780	MN163085	6 PK 1880		
MD336149	ZRK 1176	MN176569	5 PK 1219	<b>MWM</b>	
MD337406	4 PK 884	MN176570	5 PK 920	603450201075	AVX 10 x 1075
MD337407	5 PK 940	MN183019	5 PK 900	603450201075	AVX 10 x 1075 TM
MD337658	4 PK 1060	MN183597	7 PK 2415	603450201100	AVX 10 x 1100
MD338461	4 PK 940	MN183866	6 PK 1885	603450201250	AVX 10 x 1250
MD338462	5 PK 1370	MN187466	ZRK 1329	603450201275	AVX 10 x 1275
MD338513	5 PK 865	MN195737	5 PK 905	603451101325	AVX 10 x 1325
MD339525	5 PK 1070	MN980100	ZRK 1468	603451111350	AVX 10 x 1350
MD340589	6 PK 962	MN980101	423ST	603451111350	AVX 10 x 1350 TM
MD340625	ZRK 1203	MN980104	163UT	603451111400	AVX 13 x 1400 TM
MD340887	6 PK 1445	MN980107	424UT	603451311375	AVX 13 x 1375
MD342154	ZRK 1072	MN982127	448UT	603451311375	AVX 13 x 1375 TM
MD343575	4 PK 780	MQ900831	4 PK 1110		
MD343741	602ST	MQ900832	4 PK 980	<b>NISSAN</b>	
MD344478	5 PK 954	MR148271	4 PK 940	0197810924	AVX 13 x 925
MD345384	5 PK 1080	MR148323	4 PK 925	0197810934	AVX 13 x 950
MD345395	5 PK 865	MR460467	4 PK 790	0197810944	AVX 13 x 950
MD345397	5 PK 1060	MR984778	ZRK 1459	0197810954	AVX 13 x 950
MD349465	5 PK 940	MR988922	4 PK 1540	0197810984	AVX 13 x 985
MD350259	6 PK 1215	MR994718	6 PK 1870	0197810994	AVX 13 x 1000
MD350607	4 PK 715	MW30621261	603UT	0197811004	AVX 13 x 975
MD352473	166UT	MW30621589	KT 1434	0197811264	AVX 13 x 1275
MD353700	ZRK 1541	MZ701085	4 PK 925	0197811514	AVX 13 x 1500
MD355002	4 PK 980	X1145A051	ZRK 1072	0197811564	AVX 13 x 1575
MD357086	5 PK 962	XD009352	ZRK 1213	0197811574	AVX 13 x 1575
MD360214	6 PK 1775	XD030600	ZRK 1036	0197811614	AVX 13 x 1625
MD360215	6 PK 1440	XD102248	ZRK 1258	0211704523	AVX 13 x 1050
MD361162	3 PK 775	XD106103	ZRK 1388	0211707020	AVX 13 x 1075
MD361164	4 PK 855	XD111427	ZRK 1192	0211707023	AVX 13 x 1075
MD363022	4 PK 970	XD113564	ZRK 1017	0211707023K	AVX 13 x 1075



Teilenummer Part number	Abmessung Dimension	Teilenummer Part number	Abmessung Dimension	Teilenummer Part number	Abmessung Dimension
<b>NISSAN</b>		<b>NISSAN</b>		<b>NISSAN</b>	
0211708523	AVX 13 x 1100	117200W002	6 PK 1060	1172053Y20	4 PK 805
0211712523	AVX 13 x 1125	117201600	4 PK 725	1172054B00	6 PK 884
0211714253	AVX 13 x 1150	1172016A01	AVX 13 x 800	1172059S01	4 PK 875
0211776023	AVX 13 x 750	1172016A10	AVX 13 x 800	1172067A00	4 PK 1015
0211777523	AVX 13 x 775	1172016E01	4 PK 735	1172067S00	4 PK 860
0211779523	AVX 13 x 800	1172016E02	4 PK 725	1172067S01	4 PK 860
0211780523	AVX 13 x 800	1172016V01	4 PK 1110	1172069000	AVX 10 x 875
0211780528	AVX 13 x 800	1172016V02	4 PK 1110	1172069200	AVX 10 x 950
0211790023	AVX 13 x 900	1172016V11	4 PK 1110	1172069900	AVX 10 x 990
0211790523	AVX 13 x 900	1172017S00	AVX 13 x 1000	1172069901	AVX 10 x 990
0211791023	AVX 13 x 900	1172017S10	AVX 13 x 1000	1172069901	AVX 10 x 995
0211792023	AVX 13 x 925	1172018000	AVX 10 x 838	1172069T01	AVX 13 x 1150
0211792523	AVX 13 x 925	1172018001	AVX 10 x 838	117206F900	5 PK 962
117069901	AVX 10 x 990	1172018002	AVX 10 x 838	117206F905	5 PK 775
1172000Q1E	7 PK 1970	117201F700	6 PK 675	117206N200	6 PK 2245
1172000Q1T	7 PK 1705	117201F710	4 PK 654	117206N20A	6 PK 2245
1172000Q1U	5 PK 1200	117201P100	6 PK 845	1172070J00	4 PK 835
1172000QA2	6 PK 1205	117201P101	6 PK 845	1172070J05	4 PK 825
1172000QAJ	5 PK 1125	1172021000	AVX 10 x 888	1172071E10	4 PK 725
1172000QAM	6 PK 894	1172022101	AVX 10 x 913	1172071J00	4 PK 813
1172000QAN	5 PK 1130	1172022J00	AVX 13 x 1075	1172071J01	4 PK 813
1172000QAP	5 PK 1200	1172022J10	AVX 13 x 1075	1172071J05	4 PK 913
1172000QAR	3 PK 740	1172023100	AVX 10 x 888	1172073000	AVX 10 x 1050
1172000QAS	4 PK 925	1172024U00	4 PK 875	1172073600	AVX 10 x 950
1172000QAT	4 PK 905	1172025604	AVX 10 x 850	1172077701	AVX 10 x 975
1172000QAV	3 PK 740	117202600	4 PK 775	1172077702	AVX 10 x 975
1172001B00	3 PK 877	1172026E02	4 PK 775	1172077A00	4 PK 913
1172001B01	3 PK 913	1172026E12	4 PK 775	1172077A00T	4 PK 913
1172001B02	3 PK 785	1172028E10	4 PK 705	1172077A10	4 PK 913
1172001B04	3 PK 785	117202F000	4 PK 805	1172077A12	4 PK 835
1172001B05	3 PK 763	117202F005	4 PK 805	1172078000	AVX 10 x 1050
1172003J00	AVX 10 x 1140	117202F200	4 PK 825	1172078201	AVX 10 x 1025
1172003N00	5 PK 900	117202F205	4 PK 835	1172078221	AVX 10 x 950
1172005E00	AVX 13 x 900	117202M310	4 PK 715	1172080W00	AVX 10 x 920
1172005E05	AVX 13 x 900	1172030R00	6 PK 1305	11720-80W00	AVX 10 x 935
1172005E10	AVX 13 x 900	1172030R10	6 PK 1305	11720-80W00	AVX 10 x 938
1172005E15	AVX 13 x 900	11720-30W00	AVX 10 x 935	11720-80W10	AVX 10 x 935
1172005E60	AVX 13 x 775	11720-30W00	AVX 10 x 938	11720-80W10	AVX 10 x 938
1172005E60	AVX 13 x 785	1172031U00	6 PK 884	1172083000	AVX 13 x 900
1172005E65	AVX 13 x 750	1172031U02	6 PK 884	1172085G00	4 PK 913
1172005E70	AVX 13 x 775	117204007	4 PK 813	1172085G10	4 PK 913
1172005E70	AVX 13 x 785	1172042L01	4 PK 850	1172097E10	5 PK 860
1172005E75	AVX 13 x 725	1172042L02	4 PK 860	117209C601	AVX 13 x 1100
1172006E01	AVX 10 x 1050	1172042L03	4 PK 850	117209C604	AVX 13 x 1100
11720-06E06	AVX 10 x 935	1172042L12	4 PK 860	117209F600	6 PK 820
11720-06E06	AVX 10 x 938	117204A0A1	4 PK 841	117209F605	6 PK 820
1172008E01	AVX 10 x 1050	117204F100	6 PK 675	117209F610	6 PK 820
1172008E02	AVX 10 x 1050	117204F105	6 PK 884	11720AA000	4 PK 890
11720-08E06	AVX 10 x 935	117204F110	4 PK 654	11720AR000	6 PK 1950
11720-08E06	AVX 10 x 938	117204M510	6 PK 820	11720AR010	6 PK 1940
11720-08E07	AVX 10 x 935	117204M511	6 PK 820	11720AW300	7 PK 1793
11720-08E07	AVX 10 x 938	117204M512	6 PK 820	11720B1100	AVX 10 x 1050
117200C800	5 PK 950	117204P100	6 PK 1175	11720B1101	AVX 10 x 1050
117200C805	5 PK 950	117204P101	6 PK 1175	11720BC21A	7 PK 1040
117200C810	4 PK 905	117204P102	6 PK 1175	11720BC21B	7 PK 1040
117200E010	4 PK 825	117204P10A	6 PK 1145	11720BC21C	7 PK 1040
117200M000	4 PK 825	117204S100	5 PK 805	11720BN700	5 PK 1130
117200M010	4 PK 825	1172050A00	4 PK 995	11720BN701	5 PK 1200
117200M200	6 PK 825	1172050A10	4 PK 995	11720BX000	4 PK 835
117200M311	4 PK 1100	1172052F00	5 PK 935	11720BX005	4 PK 835
117200M313	4 PK 1110	1172052F10	5 PK 935	11720BX010	3 PK 668
117200N500	4 PK 1125	1172053J10	4 PK 835	11720BX015	3 PK 668
117200N502	4 PK 1125	1172053Y00	4 PK 805	11720CK80A	6 PK 1215
117200P500	4 PK 1015	1172053Y01	4 PK 805	11720D0101	AVX 10 x 875
117200W000	6 PK 1060	1172053Y10	4 PK 805	11720D2000	AVX 10 x 875



Teilenummer Part number	Abmessung Dimension	Teilenummer Part number	Abmessung Dimension	Teilenummer Part number	Abmessung Dimension
<b>NISSAN</b>		<b>NISSAN</b>		<b>NISSAN</b>	
11720D2005	AVX 10 x 875	11720V7310	4 PK 870	1192041B00	6 PK 955
11720D2005J	AVX 10 x 875	11720V7311	4 PK 870	1192041B01	6 PK 955
11720D2005K	AVX 10 x 875	11720VB500	AVX 13 x 1075	1192041B02	6 PK 955
11720D2800	AVX 13 x 850	11720VB510	AVX 13 x 1075	1192042L01	4 PK 920
11720D2811	AVX 13 x 850	11720VC101	7 PK 1640	119204F105	6 PK 955
11720D4001	4 PK 962	11720VC102	7 PK 1640	119204M500	6 PK 1115
11720D4007	4 PK 813	11720VC103	7 PK 1640	1192053J00	6 PK 1035
11720D4007T	4 PK 813	11720VC200	6 PK 1060	1192053J0010	6 PK 1038
11720D4008	4 PK 813	11720VJ200	4 PK 913	1192053J01	6 PK 1035
11720D4017	4 PK 813	11720VS40A	7 PK 1640	1192053J10	6 PK 1035
11720D4018	4 PK 813	11720W0700	AVX 13 x 875	1192053J20	4 PK 850
11720D4201	6 PK 730	11720W3411	AVX 13 x 1025	1192058S00	4 PK 920
11720D4202	4 PK 705	11720W4405	AVX 10 x 875	1192058S01	4 PK 925
11720E3000	AVX 10 x 864	11720Y4000	AVX 13 x 900	119205C000	4 PK 920
11720E3001	AVX 10 x 900	11720Y4005	AVX 13 x 875	119205F600	6 PK 955
11720E3005	AVX 10 x 900	11721H7200	AVX 10 x 975	119205U011	6 PK 1025
11720E3010	AVX 10 x 864	1175001B00	3 PK 630	1192060U01	4 PK 950
11720E3011	AVX 10 x 864	1175005E00	AVX 13 x 900	119206J900	6 PK 1115
11720E3015	AVX 10 x 864	1175005E10	AVX 13 x 900	119206J910	6 PK 1115
11720E3015	AVX 10 x 875	11750C6000	AVX 13 x 1350	1192070J00	6 PK 1035
11720E4600	AVX 10 x 850	11750D1100	AVX 13 x 750	1192077A00	4 PK 835
11720E8700	AVX 13 x 850	11750D1116	AVX 10 x 550	1192077A10	4 PK 835
11720ED00B	7 PK 1140	11750D2810	AVX 10 x 613	1192077A12	4 PK 835
11720EL00A	6 PK 1205	11750V2000	AVX 13 x 1125	1192085E01	4 PK 1180
11720EN20A	6 PK 1210	11750V5700	AVX 13 x 835	1192085E11	4 PK 1180
11720ET00A	6 PK 1210	11750Y4015	AVX 13 x 1200	1192097E20	4 PK 1180
11720F6300	4 PK 1050	1192000QAB	5 PK 1110	1192097E26	4 PK 1180
11720F6310	4 PK 1050	1192001B10	4 PK 813	119209F500	6 PK 1025
11720F6501	4 PK 1050	1192001M01	AVX 13 x 800	119209F505	6 PK 1025
11720F6600	4 PK 1040	1192004U00	4 PK 950	119209F605	6 PK 1115
11720G0300	AVX 10 x 838	1192004W00	AVX 13 x 825	11920AG900	4 PK 950
11720G0390J	AVX 10 x 838	1192005E05	AVX 13 x 960	11920BX000	4 PK 1065
11720G0390K	AVX 10 x 838	1192005E15	AVX 13 x 960	11920BX005	6 PK 1070
11720H7200	AVX 10 x 965	1192006P01	4 PK 950	11920BX00A	4 PK 1065
11720H7210	AVX 10 x 975	119200E000	6 PK 1025	11920C6000	AVX 13 x 975
11720JD00B	7 PK 1150	119200E001	6 PK 1025	11920C8600	AVX 13 x 1500
11720JD00C	7 PK 1150	119200H600	4 PK 855	11920D4007	4 PK 813
11720JG70B	7 PK 1705	119200H610	4 PK 855	11920D4201	6 PK 884
11720N8500	AVX 10 x 900	119200M800	6 PK 1015	11920F6100	4 PK 1415
11720N8503	AVX 10 x 950	119200M801	6 PK 1015	11920F6110	4 PK 1415
11720N9510	AVX 10 x 950	119200P500	4 PK 954	11920F6111	4 PK 1415
11720N9510	AVX 10 x 975	119200W000	5 PK 1280	11920F6501	4 PK 966
11720N9515	AVX 10 x 950	119200W001	5 PK 1280	11920H8900	AVX 13 x 800
11720N9520	AVX 10 x 975	119200W002	5 PK 1280	11920H8900	AVX 13 x 810
11720N9700	AVX 10 x 900	1192010G01	AVX 13 x 1450	11920M6601	AVX 13 x 850
11720N9710	AVX 10 x 888	1192010G02	AVX 13 x 1450	11920M6660	AVX 13 x 825
11720N9800	AVX 10 x 875	1192016E01	6 PK 1195	11920N9505	AVX 13 x 850
11720P0300	AVX 10 x 900	1192016V00	4 PK 913	11920Q5200	4 PK 835
11720P0305	AVX 13 x 875	1192016V10	4 PK 913	11920V2000	AVX 13 x 900
11720P8010	AVX 13 x 1125	119201F700	6 PK 955	11920V2100	AVX 13 x 825
11720Q5201	4 PK 813	119201P100	4 PK 1015	11920V7301	4 PK 845
11720S0101	AVX 10 x 864	119201P110	4 PK 1015	11920V7302	4 PK 850
11720V0702	AVX 13 x 975	1192021B00	4 PK 835	11920V7311	4 PK 845
11720V0703	AVX 13 x 975	1192021B05	4 PK 825	1195004U00	4 PK 950
11720V0710	AVX 13 x 975	1192021M00	AVX 13 x 825	1195006E01	AVX 10 x 950
11720V2000	AVX 13 x 875	1192027N00	4 PK 1190	1195008E00	AVX 10 x 950
11720V2010	AVX 13 x 900	1192028E10	6 PK 884	1195008E01	AVX 10 x 950
11720V5300	4 PK 1020	1192028L00	AVX 13 x 900	1195008E05	AVX 10 x 950
11720V5302	4 PK 1030	119202F200	6 PK 1025	11950-08E05	AVX 10 x 938
11720V5303	4 PK 1020	119202F205	6 PK 1025	11950-08E15	AVX 10 x 935
11720V5312	4 PK 1030	119202Y501	6 PK 1105	11950-08E15	AVX 10 x 938
11720V5313	4 PK 1030	1192030R10	4 PK 875	11950-08E5	AVX 10 x 935
11720V7300	4 PK 870	1192030W00	AVX 13 x 825	119500M200	4 PK 813
11720V7301	4 PK 870	1192031U00	6 PK 1100	119500M210	4 PK 725
11720V7302	4 PK 855	1192031U02	6 PK 1100	119500P600	4 PK 905



Teilenummer Part number	Abmessung Dimension	Teilenummer Part number	Abmessung Dimension	Teilenummer Part number	Abmessung Dimension
<b>NISSAN</b>		<b>NISSAN</b>		<b>NISSAN</b>	
119500P610	4 PK 913	11950V7710	3 PK 830	1307000QAE	398ST
119500P611	4 PK 905	11950W4410	AVX 13 x 800	1307000QAF	398ST
1195016E10	4 PK 1040	1302800QAC	ZRK 1428	1307001B00	813ST
1195018E10	4 PK 1040	1302801700	ZRK 1040	1307001B01	813ST
1195024U05	4 PK 970	1302801M00	ZRK 1275	1307001M00	812UT
1195031U00	4 PK 775	1302801M10	ZRK 1275	1307005E00	818UT
1195031U01	4 PK 775	1302801M85	ZRK 1275	1307005E10	818UT
1195031U02	4 PK 775	130280B700	ZRK 1326	1307016A10	808UT
1195035F00	4 PK 841	130280B725	ZRK 1326	1307016A11	808UT
1195041B00	4 PK 763	130280B785	ZRK 1326	130702J600	810ST
1195041B01	4 PK 763	1302811M00	ZRK 1042	1307057J00	810ST
1195041B02	4 PK 763	1302811M10	ZRK 1042	1307057J01	810ST
1195042L00	3 PK 855	1302811MOO	ZRK 1042	1307057J10	810ST
1195042L10	3 PK 855	1302812G00	ZRK 1370	130706F900	254ST
119504F105	4 PK 763	1302816A01	ZRK 1095	130706F901	254ST
119504S100	5 PK 1230	1302816A10	ZRK 1095	13070D0100	817ST
1195053J10	4 PK 845	1302816E00	ZRK 1370	13070V7201	807ST
1195053J20	4 PK 845	1302816E10	ZRK 1370	13070V7203	807ST
1195054C00	4 PK 920	1302820R00	ZRK 1040	1307405E00	819UT
1195054C10	4 PK 920	1302820R85	ZRK 1040	130750M900	810ST
1195058S01	3 PK 850	130282J600	ZRK 1169	1307700QAA	399UT
1195058S02	3 PK 850	130282J625	ZRK 1169	1307700QAD	600ST
1195059S02	4 PK 950	130282J685	ZRK 1169	1307700QAF	630UT
1195059W00	AVX 13 x 750	1302831B10	ZRK 1206	1307700QAG	169ST
119505C005	4 PK 1015	1302831B85	ZRK 1206	1307700QAJ	630UT
119505F600	4 PK 763	1302831B86	ZRK 1206	1307700QAL	169ST
119505J001	4 PK 855	1302850A00	ZRK 1275	1307754A00	809UT
119505J010	4 PK 855	1302851E00	ZRK 1221	1307754A01	809UT
119505J011	4 PK 855	1302851E10	ZRK 1221	130776F900	255UT
1195060U05	7 PK 1280	1302851E25	ZRK 1221	130776F901	255UT
1195065F10	3 PK 877	1302851E85	ZRK 1221	13077V7200	806UT
1195067S00	3 PK 855	1302854A00	ZRK 1095	13077V7202	806UT
1195067S01	3 PK 855	1302854A01	ZRK 1095	13077V7203	806UT
1195070J00	4 PK 845	1302854A10	ZRK 1095	1370BN700	KT 1368
1195070J05	4 PK 845	1302854A25	ZRK 1095	14853H9910	AVX 10 x 1000
1195071E00	4 PK 900	1302854A85	ZRK 1095	14853M9910	AVX 10 x 1000
1195071E10	4 PK 900	1302857J01	ZRK 1169	1680600Q0A	KT 1434
1195072B00	4 PK 725	1302857J25	ZRK 1169	1680600Q0B	ZRK 1067
1195072B01	4 PK 725	1302861A00	ZRK 1042	1680600QA1	ZRK 1470
1195085E00	4 PK 1040	130287C000	ZRK 1189	1680600QA6	KT 1406
1195086L00	4 PK 900	1302881T00	ZRK 1450	1680600QA7	ZRK 1470
1195097E00	4 PK 985	1302881T25	ZRK 1450	1680600QA8	KT 1368
119509F600	4 PK 845	1302885E00	ZRK 1370	1680600QAA	ZRK 1470
119509F605	4 PK 845	1302885E86	ZRK 1370	1680600QAB	KT 1126
119509F610	4 PK 850	13028AW300	ZRK 1428	1680600QAB	KT 1406
11950AR000	4 PK 950	13028AW301	ZRK 1428	1680600QAF	KT 1434
11950C8600	AVX 13 x 1275	13028BN700	ZRK 1325	1680600QAG	KT 1126
11950D2015	AVX 13 x 750	13028D0100	ZRK 1038	1680600QAG	KT 1392
11950D2016	AVX 10 x 550	13028D1700	ZRK 1040	1680600QAJ	KT 1434
11950D2017	AVX 13 x 750	13028D2800	ZRK 1095	1680600QAT	KT 1126
11950D4200	4 PK 940	13028D4211	ZRK 1221	1680600QAX	KT 1368
11950D4201	4 PK 920	13028R7400	ZRK 1271	1680600QBB	KT 1368
11950D4202	4 PK 940	13028V5000	ZRK 1058	1680600QBE	ZRK 1325
11950D4210	4 PK 940	13028V5001	ZRK 1058	168060M900	ZRK 1300
11950D4211	4 PK 920	13028V5200	ZRK 1370	1680613C00	ZRK 1287
11950EB300	4 PK 825	13028V5201	ZRK 1370	1680616A00	ZRK 1300
11950EB30A	4 PK 825	13028V5220	ZRK 1370	1680616A10	ZRK 1300
11950F6101	3 PK 1000	13028V5221	ZRK 1370	168062J600	ZRK 1324
11950F6102	3 PK 1000	13028V7210	ZRK 1282	168062J625	ZRK 1324
11950F6111	3 PK 1000	13028V7211	ZRK 1282	1680654A00	ZRK 1300
11950V7300	3 PK 830	13028V7225	ZRK 1282	1680654A10	ZRK 1300
11950V7301	3 PK 835	1307000QAA	168UT	1680654A25	ZRK 1300
11950V7302	3 PK 830	1307000QAB	335ST	168069C600	ZRK 1189
11950V7310	3 PK 830	1307000QAC	346ST	16806G5500	ZRK 1287
11950V7311	3 PK 835	1307000QAD	398ST	16806G5510	ZRK 1287



Teilenummer Part number	Abmessung Dimension	Teilenummer Part number	Abmessung Dimension	Teilenummer Part number	Abmessung Dimension
<b>NISSAN</b>		<b>OPEL</b>		<b>OPEL</b>	
16806G5525	ZRK 1287	11282245848	5 PK 1815	1340661	5 PK 880
16806V0700	ZRK 1032	1136713010	AVX 13 x 1450	1340662	6 PK 1590
16806V0710	ZRK 1032	11720DB000	7 PK 1920	1340663	6 PK 1900
16806V0711	ZRK 1032	1336671	AVX 10 x 900	1340664	6 PK 1800
16806V7200	ZRK 1282	1340003	5 PK 1355	1340665	6 PK 1870
16806Y9701	ZRK 1032	1340004	6 PK 1718	1340666	6 PK 1863
2106629W00	AVX 13 x 925	1340007	AVX 10 x 888	1340667	5 PK 1030
21066R8300	AVX 13 x 1000	1340008	6 PK 1245	1340668	5 PK 880
21066T9307	AVX 13 x 950	1340017	5 PK 1355	1340668	AVX 10 x 975
2106710600	AVX 10 x 975	1340248	6 PK 1330	1340669	5 PK 880
2106710800	AVX 10 x 990	1340261	6 PK 1413	1340669	AVX 10 x 925
2106729913	AVX 10 x 838	1340272	6 PK 1900	1340671	5 PK 1355
2106737602	AVX 13 x 950	1340273	6 PK 1900	1340671	AVX 10 x 900
2106737603	AVX 13 x 950	1340275	6 PK 1555	1340672	5 PK 1355
2106773000	AVX 10 x 1050	1340279	6 PK 1450	1340673	AVX 10 x 1075
2106778500	AVX 10 x 864	1340283	6 PK 2390	1340673	AVX 10 x 1075 TM
21067L0100	AVX 13 x 925	1340510	6 PK 1863	1340674	5 PK 1030
2114090104	AVX 13 x 1625	1340527	6 PK 2120	1340674	AVX 10 x 1050
2114090503	AVX 13 x 1575	1340538	219SR	1340675	5 PK 880
2114096002	AVX 13 x 1575	1340552	219SR	1340676	AVX 10 x 1350
2114096005	AVX 13 x 1575	1340600	6 PK 1250	1340677	5 PK 1030
2114096010	AVX 13 x 1575	1340601	6 PK 1590	1340678	5 PK 880
2160037W02	AVX 13 x 750	1340603	4 PK 966	1340678	AVX 10 x 864
2320190001	AVX 13 x 750	1340605	AVX 10 x 1025	1340679	AVX 10 x 925
2320190009	AVX 13 x 750	1340607	6 PK 1795	1340680	AVX 10 x 950
2436029000	277UT	1340608	6 PK 1900	1340681	AVX 13 x 915
2437029000	274ST	1340611	5 PK 1815	1340682	AVX 10 x 1350
7700109632	ZRK 1067	1340612	AVX 10 x 913	1340683	6 PK 1600
7700110203	ZRK 1462	1340613	6 PK 1725	1340684	AVX 10 x 1350
7700111822	346ST	1340614	6 PK 1900	1340685	AVX 10 x 1275
7701473849	KT 1392	1340615	6 PK 2260	1340686	AVX 10 x 1125
8200020924	5 PK 1130	1340616	6 PK 1800	1340686	AVX 10 x 1140
8200039519	ZRK 1325	1340617	6 PK 1460	1340687	AVX 10 x 888
8200064664	342ST	1340618	6 PK 1530	1340689	AVX 10 x 1150
8200127467	398ST	1340619	6 PK 894	1340689	AVX 10 x 1175
8200127627	ZRK 1462	1340620	6 PK 1725	1340694	AVX 10 x 1325
8200243021	6 PK 1205	1340621	6 PK 1725	1340696	AVX 10 x 888
8200356446	7 PK 1970	1340622	AVX 10 x 925	1340697	AVX 10 x 900
A127AV200AG	AVX 10 x 875	1340625	6 PK 1900	1340699	AVX 10 x 1140
A172067A00	4 PK 1015	1340626	6 PK 1800	1340703	AVX 10 x 900
A195042L00	3 PK 855	1340627	6 PK 1800	1340704	AVX 10 x 888
A302854A85	ZRK 1095	1340628	5 PK 1355	1340705	AVX 10 x 950
A680613C25	ZRK 1287	1340629	5 PK 1230	1340706	AVX 10 x 950
AY1404154M	4 PK 1540	1340635	5 PK 1210	1340707	AVX 10 x 950
AY1405107M	5 PK 1070	1340636	5 PK 1680	1340709	AVX 10 x 925
AY14060922	6 PK 925	1340637	5 PK 940	1340710	AVX 10 x 950
		1340639	6 PK 1870	1340712	AVX 10 x 975
		1340640	4 PK 884	1340713	AVX 10 x 925
		1340641	5 PK 1355	1340713	AVX 10 x 938
		1340642	5 PK 1230	1340714	AVX 10 x 913
		1340643	6 PK 1530	1340718	AVX 10 x 960
		1340644	6 PK 894	1340718	AVX 10 x 965
		1340645	6 PK 1460	1340720	AVX 10 x 1000
		1340646	6 PK 1800	1340721	5 PK 1015
		1340647	6 PK 1900	1340723	AVX 10 x 1025
		1340648	6 PK 1725	1340724	5 PK 970
		1340649	6 PK 2020	1340725	AVX 13 x 875
		1340650	5 PK 1255	1340727	AVX 13 x 925
		1340651	6 PK 1863	1340728	6 PK 1460
		1340652	5 PK 1680	1340729	AVX 10 x 920
		1340653	219SR	1340730	AVX 10 x 935
		1340657	5 PK 1255	1340730	AVX 10 x 938
		1340658	5 PK 1210	1340734	AVX 10 x 935
		1340659	6 PK 1863	1340734	AVX 10 x 938
		1340660	5 PK 1030	1340734	AVX 10 x 940
<b>OPEL</b>					
090091742	AVX 10 x 888				
090108360	ZRK 1014				
090169081	AVX 10 x 875				
090169083	AVX 10 x 950				
090324699	ZRK 1016				
090409800	AVX 10 x 940				
090410387	AVX 10 x 960				
090411009	AVX 10 x 1025				
090412115	AVX 10 x 920				
090448698	AVX 10 x 900				
09129067	AVX 10 x 925				
09292426	AVX 10 x 888				
09292427	AVX 10 x 900				
11053599	AVX 10 x 900				
11063969	AVX 10 x 800				
11064889	AVX 10 x 950				
11072021	AVX 10 x 888				





Teilenummer Part number	Abmessung Dimension	Teilenummer Part number	Abmessung Dimension	Teilenummer Part number	Abmessung Dimension
<b>OPEL</b>		<b>OPEL</b>		<b>OPEL</b>	
1340735	AVX 10 x 960	1855750	6 PK 2055	4410548	342ST
1340736	5 PK 985	24404052	5 PK 1230	4411717	5 PK 1125
1340737	AVX 10 x 1025	24413292	6 PK 1900	4414599	6 PK 1800
1340738	AVX 10 x 920	24413293	6 PK 1800	4416361	7 PK 1105
1340739	AVX 10 x 900	24413294	6 PK 1870	4416369	631UT
1340742	6 PK 1900	24419361	5 PK 1255	4416576	ZRK 1475
1340743	6 PK 1725	24419362	5 PK 1210	4418675	7 PK 1793
1340745	6 PK 1795	24419363	6 PK 2020	4430217	6 PK 1840
1340746	6 PK 1530	24422964	ZRK 1455	4430891	KT 1434
1340747	6 PK 894	24426500	519ST	4430895	KT 1409
1354707	AVX 13 x 875	24426540	5 PK 1030	4431667	7 PK 1970
1603688	KT 1465	24435940	5 PK 1030	4431762	KT 1392
1606190	KT 1024	24435953	5 PK 880	4431763	ZRK 1462
1606191	KT 1030	24451895	ZRK 1026	4434866	7 PK 2000
1606192	KT 1030	24452029	6 PK 1800	4435288	7 PK 1110
1606193	KT 1025	24452031	6 PK 1880	4500033	5 PK 1200
1606194	KT 1323	24462695	6 PK 1990	4500034	6 PK 858
1606196	KT 1385	24466972	5 PK 1030	4500056	6 PK 845
1606197	KT 1159	24466975	5 PK 1025	4500879	ZRK 1332
1606198	KT 1384	24466976	5 PK 880	4501807	KT 1340
1606262	KT 1207	3009003	AVX 10 x 875	4504163	ZRK 1022
1606274	KT 1024	301201A	AVX 10 x 888	4506085	KT 1392
1606281	KT 1329	3012097	AVX 10 x 1000	4506086	ZRK 1462
1606305	KT 1468	3013008	AVX 10 x 950	4506090	398ST
1606306	KT 1207	3013009	AVX 10 x 913	4506092	399UT
1606314	KT 1405	3013010	AVX 10 x 925	4506181	6 PK 1795
1606340	KT 1425	3847708	AVX 10 x 1350	4506189	6 PK 1145
1606342	KT 1425	3847710	AVX 10 x 1350	4710920	4 PK 763
1606343	KT 1427	3848346	AVX 10 x 975	4803451	6 PK 2404
1606349	KT 1427	395464985	6 PK 1318	4805292	ZRK 1256
1606356	KT 1405	4300342	AVX 13 x 1500	4805335	ZRK 1595
1606360	KT 1443	4400204	357ST	4808188	6 PK 1890
1606368	KT 1002	4401416	298ST	4810711	5 PK 1025
1606369	KT 1002	4401428	KT 1392	545482	AVX 10 x 800
1606385	KT 1027	4401429	ZRK 1462	55185077	6 PK 1185
1606387	KT 1421	4401430	398ST	55185078	6 PK 1318
1606389	KT 1465	4401489	631UT	55202584	6 PK 800
1606390	KT 1465	4401601	ZRK 1195	55350420	5 PK 1450
1854422	210SR	4401609	602ST	55350421	5 PK 1545
1854429	508UR	4401649	6 PK 1138	55350580	506UT
1854433	210SR	4401801	KT 1229	55351458	5 PK 1030
1854436	210SR	4402116	6 PK 1138	55351459	5 PK 880
1854704	AVX 10 x 888	4402599	6 PK 1130	55351782	ZRK 1330
1854706	AVX 10 x 785	4402631	298ST	55353810	396ST
1854708	6 PK 2228	4402632	299ST	55354681	6 PK 1880
1854710	AVX 10 x 800	4402638	ZRK 1069	55562422	5 PK 1355
1854711	AVX 10 x 888	4402639	631UT	55562423	5 PK 1355
1854713	6 PK 2270	4402690	603UT	55562866	6 PK 1900
1854714	6 PK 2260	4403027	ZRK 1312	55563395	6 PK 1900
1854715	4 PK 805	4403144	359UT	55563925	6 PK 1555
1854716	AVX 13 x 1525	4403270	603UT	55564654	6 PK 1370
1854718	AVX 10 x 785	4403471	6 PK 850	55564655KA	6 PK 1413
1854719	AVX 13 x 875	4403472	6 PK 870	55565301	6 PK 1450
1854722	4 PK 780	4404042	6 PK 870	55566900	6 PK 1718
1854723	6 PK 2260	4404043	6 PK 850	55566905	6 PK 1245
1854725	4 PK 780	4405275	7 PK 1145	55567191	519ST
1854726	AVX 13 x 1500	4405280	7 PK 1793	55567786	6 PK 2390
1854727	AVX 13 x 1500	4408352	5 PK 1125	55570508	6 PK 1330
1854728	6 PK 2020	4408392	ZRK 1475	5636086	ZRK 1081
1854730	AVX 13 x 1325	4408922	346ST	5636106	ZRK 1440
1854730	AVX 13 x 1325 TM	4408922	602ST	5636130	425ST
1854733	6 PK 2285	4409473	ZRK 1067	5636343	ZRK 1540
1854734	6 PK 2040	4409485	KT 1434	5636344	ZRK 1466
1854736	4 PK 805	4410172	6 PK 1795	5636350	ZRK 1256
1855700	6 PK 2055	4410513	346ST	5636351	ZRK 1023

Teilenummer Part number	Abmessung Dimension	Teilenummer Part number	Abmessung Dimension	Teilenummer Part number	Abmessung Dimension
<b>OPEL</b>		<b>OPEL</b>		<b>OPEL</b>	
5636354	ZRK 1022	5867298320	6 PK 1370	636366	ZRK 1280
5636355	ZRK 1025	5867314180	6 PK 2013	636367	ZRK 1011
5636356	ZRK 1292	5867314190	6 PK 2065	636368	ZRK 1016
5636357	KT 1024	60169195	AVX 10 x 925	636370	ZRK 1278
5636357	ZRK 1024	614531	5 PK 1030	636371	ZRK 1014
5636358	ZRK 1291	6340540	5 PK 2020	636372	ZRK 1292
5636359	ZRK 1256	6340600	5 PK 1240	636375	ZRK 1111
5636361	ZRK 1023	6340601	5 PK 1240	636383	521ST
5636362	ZRK 1024	6340602	6 PK 1990	636415	509UT
5636363	ZRK 1291	6340603	6 PK 1880	636416	505UT
5636364	ZRK 1292	6340605	5 PK 1450	636418	504UT
5636369	ZRK 1330	6340606	5 PK 1545	636420	418UT
5636370	ZRK 1256	6340609	5 PK 1030	636421	500UT
5636372	ZRK 1256	6340610	5 PK 880	636422	501UT
5636373	ZRK 1026	6340611	6 PK 1920	636423	503UT
5636374	ZRK 1023	6340613	5 PK 1370	636424	525UT
5636376	ZRK 1431	6340615	6 PK 1185	636560	ZRK 1278
5636384	396ST	6340616	6 PK 1318	636561	ZRK 1292
5636395	436UT	6340617	6 PK 1275	636562	ZRK 1016
5636402	ZRK 1440	6340618	6 PK 1605	636563	ZRK 1015
5636415	507UT	6340619	6 PK 1055	636564	ZRK 1011
5636416	506UT	6340620	6 PK 1413	636565	ZRK 1278
5636418	525UT	6340622	6 PK 1880	636566	ZRK 1292
5636419	507UT	6340623	6 PK 1800	636567	ZRK 1011
5636421	525UT	6340624	7 PK 1920	636568	ZRK 1023
5636422	525UT	6340625	6 PK 1625	636569	ZRK 1025
5636423	223UT	6340626	5 PK 1210	636570	ZRK 1235
5636424	504UT	6340627	5 PK 1210	636571	ZRK 1022
5636425	509UT	6340633	6 PK 1800	636573	ZRK 1291
5636426	506UT	6340634	6 PK 1460	636575	ZRK 1024
5636427	507UT	6340635	6 PK 1530	636576	ZRK 1025
5636429	518ST	6340636	6 PK 1725	636578	ZRK 1097
5636436	ZRK 1455	6340637	6 PK 1900	636579	ZRK 1022
5636451	425ST	6340638	6 PK 2020	636654	519ST
5636452	ZRK 1455	6340639	5 PK 1230	636666	ZRK 1280
5636454	418UT	6340640	5 PK 1355	636723	395ST
5636455	506UT	6340641	5 PK 1240	636725	519ST
5636456	371ST	6340656	5 PK 940	636726	515ST
5636463	ZRK 1540	6340657	5 PK 1210	636727	518ST
5636469	425ST	6340658	6 PK 1605	636728	KT 1461
5636475	371ST	6340660	5 PK 1680	636729	395ST
5636486	425ST	6340661	6 PK 1370	636730	436UT
5636501	525UT	6340662	6 PK 1310	636731	516ST
5636560	ZRK 1292	6340663	6 PK 1055	636732	502ST
5636561	KT 1024	6340665	6 PK 1413	636734	510ST
5636562	ZRK 1023	6340666	6 PK 1370	636735	511ST
5636563	ZRK 1291	6340668	6 PK 1600	636737	515ST
5636564	ZRK 1026	6340669	6 PK 1625	636738	518ST
5636565	KT 1024	6340671	6 PK 1250	636739	519ST
5636565	ZRK 1024	6340672	6 PK 1610	636740	510ST
5636566	ZRK 1330	6340673	6 PK 1590	636741	520ST
5636569	ZRK 1025	6340674	6 PK 1370	636742	516ST
5636576	ZRK 1025	6340675	6 PK 1413	636745	520ST
5636721	510ST	636160	425ST	636746	518ST
5636722	510ST	636227	ZRK 1081	636747	436UT
5636725	425ST	636228	ZRK 1023	636748	510ST
5636730	524UT	636352	ZRK 1280	636749	510ST
5636732	519ST	636355	ZRK 1097	636928	436UT
5636733	519ST	636357	ZRK 1111	636929	425ST
5636738	515ST	636359	ZRK 1278	636931	371ST
5636740	519ST	636360	ZRK 1013	64552245451	4 PK 780
5636743	421UT	636361	ZRK 1014	6536364	ZRK 1292
5636745	371ST	636363	ZRK 1278	6606028	KT 1426
5636746	396ST	636364	ZRK 1015	6606029	KT 1400
5636978	426UT	636365	ZRK 1016	6650346	AVX 10 x 975



Teilenummer Part number	Abmessung Dimension
----------------------------	------------------------

Teilenummer Part number	Abmessung Dimension
----------------------------	------------------------

Teilenummer Part number	Abmessung Dimension
----------------------------	------------------------

## OPEL

## OPEL

## OPEL

7700109477	6 PK 1795
7700865429	6 PK 1138
815971	522UT
8200023912	6 PK 1145
8200059423	6 PK 850
8200059425	6 PK 870
8200113203	6 PK 1795
8941464230	AVX 13 x 1525
8943855610	ZRK 1280
8944499307A	ZRK 1280
8944503950	AVX 13 x 1450
8944686520	AVX 13 x 875
8972328750	6 PK 1275
8972328760	6 PK 1625
8973242970	6 PK 1600
8980100460	6 PK 1625
90006259	AVX 10 x 875
90006263	AVX 10 x 888
90006265	AVX 10 x 975
90006266	AVX 10 x 925
90006267	AVX 10 x 913
90076999	AVX 10 x 1075
90076999	AVX 10 x 1075 TM
90080214	ZRK 1111
90088832	AVX 10 x 875
90090214	ZRK 1111
90091612	AVX 10 x 950
90091742	AVX 10 x 888
90091743	AVX 10 x 900
90096480	AVX 10 x 950
90108360	ZRK 1014
90122429	ZRK 1278
90128821	ZRK 1013
90156794	AVX 10 x 825
90156974	AVX 10 x 825
90169079	AVX 10 x 960
90169080	AVX 10 x 925
90169081	AVX 10 x 875
90169082	AVX 10 x 1090
90169083	AVX 10 x 950
90169084	AVX 10 x 850
90169195	AVX 10 x 938
90169520	AVX 10 x 975
90180131	500UT
90183140	AVX 10 x 920
90183426	AVX 10 x 875
90183427	AVX 10 x 888
90193440	AVX 10 x 913
90194098	AVX 10 x 763
90194995	AVX 10 x 813
90215247	AVX 10 x 785
90231797	AVX 10 x 1000
90231883	ZRK 1016
90233194	5 PK 1015
90234902	ZRK 1278
90260872	AVX 10 x 800
90264022	501UT
90271857	AVX 10 x 1000
90280404	ZRK 1011
90280872	AVX 10 x 800
90281312	ZRK 1015
90281901	AVX 10 x 1025
90285678	6 PK 2228
90285679	6 PK 1460
90299369	AVX 13 x 875

90299440	AVX 10 x 913
90299503	5 PK 970
90323501	502ST
90323503	603UT
90324097	508UR
90324698	ZRK 1016
90324699	ZRK 1016
90325578	ZRK 1278
90351803	AVX 10 x 913
90352379	ZRK 1014
90352928	AVX 10 x 935
90352928	AVX 10 x 938
90353176	510ST
90353179	ZRK 1292
90353211	ZRK 1278
90354782	ZRK 1292
90354783	510ST
90354783	ZRK 1016
90399370	AVX 10 x 690
90409610	AVX 10 x 1000
90409781	6 PK 2270
90409782	6 PK 1900
90409800	AVX 10 x 935
90409800	AVX 10 x 938
90409900	ZRK 1278
90410014	ZRK 1278
90410223	ZRK 1292
90410224	ZRK 1011
90410225	ZRK 1011
90410316	5 PK 985
90410386	AVX 10 x 888
90410387	AVX 10 x 965
90410700	6 PK 1725
90410771	ZRK 1022
90410784	ZRK 1015
90411028	6 PK 1795
90411769	518ST
90411770	ZRK 1023
90411773	505UT
90411774	515ST
90411775	ZRK 1025
90411782	509UT
90411787	504UT
90412730	506UT
90412731	507UT
90412783	519ST
90412885	6 PK 894
90444421	6 PK 1530
90444422	6 PK 1530
90444423	6 PK 1795
9044486	AVX 10 x 813
90448002	6 PK 2260
90466255	AVX 10 x 913
90466262	ZRK 1025
90466474	525UT
90466524	6 PK 1900
90467130	6 PK 1460
90469984	ZRK 1023
90469987	ZRK 1025
90486316	6 PK 894
90490781	6 PK 2270
90499401	510ST
90500227	6 PK 1725
90500228	6 PK 1900
90500354	6 PK 2260

90500360	ZRK 1022
90501383	6 PK 1530
90501384	6 PK 1460
90501385	6 PK 2260
90501386	6 PK 1725
90502286	AVX 10 x 925
90502734	6 PK 1900
90502735	6 PK 1800
90509168	219SR
90509315	5 PK 1815
90509751	4 PK 780
90510025	AVX 10 x 913
90510253	6 PK 1800
90510610	6 PK 1530
90510611	6 PK 894
90510612	6 PK 894
90512538	4 PK 780
90528200	518ST
90528603	395ST
90528761	6 PK 2020
90529187	525UT
90529188	525UT
90529810	223UT
90529914	6 PK 1870
90530123	519ST
90530124	518ST
90530125	515ST
90530126	395ST
90530286	ZRK 1023
90530598	ZRK 1025
90530599	ZRK 1022
90531033	ZRK 1025
90531677	ZRK 1292
90531678	ZRK 1292
90531679	ZRK 1024
90531680	ZRK 1024
90531681	ZRK 1291
90531858	ZRK 1026
90531966	5 PK 1355
90531967	5 PK 1230
90541338	6 PK 1800
90542746	5 PK 1355
90542748	5 PK 1230
90542860	525UT
90543739	525UT
90543873	219SR
90570371	ZRK 1023
90570525	510ST
90570913	507UT
90571757	4 PK 884
90573797	5 PK 940
90581641	5 PK 1255
90581642	6 PK 1863
90710530	511ST
90880972	AVX 10 x 800
9108204	357ST
9109416	298ST
9109429	ZRK 1462
9109430	398ST
9109601	ZRK 1195
9109609	602ST
9109649	6 PK 1138
9110116	6 PK 1138
9110599	6 PK 1130
9110631	298ST





Teilenummer Part number	Abmessung Dimension	Teilenummer Part number	Abmessung Dimension	Teilenummer Part number	Abmessung Dimension
<b>OPEL</b>		<b>OPEL</b>		<b>OPEL</b>	
9110632	299UT	9129465	6 PK 1795	93181712	6 PK 1460
9110638	ZRK 1069	9129468	6 PK 1900	93181714	6 PK 1530
9110639	631UT	9129851	6 PK 2020	93181716	6 PK 1725
9111144	359UT	91580003	518ST	93181718	6 PK 1900
9111471	6 PK 850	9158004	515ST	93181720	6 PK 2020
9111472	6 PK 870	9158380	6 PK 1460	93181966	371ST
9112042	6 PK 870	9160333	5 PK 1200	93181984	6 PK 1370
9112043	6 PK 850	9160334	6 PK 858	93182238	5 PK 1230
91126379	5 PK 1355	9160356	6 PK 845	93182241	5 PK 1355
91126380	5 PK 1230	9179797	5 PK 1240	93182264	5 PK 940
91126381	6 PK 1530	9192568	5 PK 1255	93182266	5 PK 1210
91126382	6 PK 894	9194660	5 PK 1210	93182272	5 PK 1680
91126384	6 PK 1460	9194661	5 PK 1210	93182274	5 PK 1240
91126385	6 PK 1800	9194939	6 PK 1863	93185361	6 PK 1370
91126386	6 PK 1900	9195191	5 PK 1030	93185569	5 PK 1255
91126387	6 PK 1725	9195192	5 PK 880	93185756	6 PK 2120
91126402	6 PK 1863	9196546	6 PK 1863	93185849	KT 1405
91126403	5 PK 1680	9196547	6 PK 1863	93186955	7 PK 1105
91131979	6 PK 1863	9198522	6 PK 1145	93188702	ZRK 1475
91132010	5 PK 1030	9198828	5 PK 1355	93190604	6 PK 1370
91140570	AVX 10 x 825	9198829	5 PK 1355	93190605	6 PK 1413
91142246	AVX 10 x 875	9201528	ZRK 1462	93192015	6 PK 1413
91149489	6 PK 1530	9201537	398ST	93192778	ZRK 1097
91150005	6 PK 1725	9201540	399UT	93195484	7 PK 1105
91151716	6 PK 1800	9201679	5 PK 1030	93195485	7 PK 1793
91153769	8 PK 2188	9201688	5 PK 880	93196419	4 PK 763
91158702	ZRK 1067	9201722	5 PK 1030	93198391	6 PK 1795
91159962	5 PK 1125	9201723	5 PK 880	93198427	7 PK 2000
91159999	ZRK 1475	9201850	6 PK 1795	93198514	7 PK 1110
91160164	602ST	9202478	510ST	94108204	AVX 13 x 1325
9117585	5 PK 1210	92061744	6 PK 2055	94108204	AVX 13 x 1325 TM
9117586	5 PK 1210	92061745	6 PK 2055	94120507	ZRK 1280
9117587	5 PK 1680	92063918	ZRK 1023	94146423	AVX 13 x 1525
9117588	5 PK 1680	92063944	ZRK 1256	94149432	516ST
9117589	5 PK 940	92065368	396ST	94333098	AVX 10 x 950
9117590	5 PK 940	9224265	5 PK 1355	94337004	AVX 13 x 925
9118367	4 PK 805	9224371	5 PK 1680	94380679	ZRK 1097
9118611	5 PK 1355	9240033	418UT	94382106	4 PK 966
9118612	5 PK 1230	93160191	6 PK 1795	94382107	4 PK 805
9118613	6 PK 1530	93160244	342ST	94382214	521ST
9118614	6 PK 894	93160750	5 PK 1125	94382215	522UT
9118616	6 PK 1460	93161358	6 PK 1840	94385561	ZRK 1280
9118617	6 PK 1800	93161481	KT 1409	94442970	AVX 13 x 1500
9118618	6 PK 1900	93161809	7 PK 1970	94482166	AVX 13 x 1450
9118619	6 PK 1725	93171378	5 PK 2020	949602	8 PK 2188
9118620	6 PK 2020	93172363	5 PK 1240	950350	AVX 10 x 875
9118624	6 PK 1863	93172364	5 PK 1240	950350	AVX 10 x 888
9118721	5 PK 1255	93172366	5 PK 1240	950351	AVX 10 x 888
9118722	5 PK 1680	93172367	5 PK 1240	950352	AVX 10 x 850
9118848	219SR	93172395	6 PK 1990	950353	AVX 10 x 875
9120501	KT 1461	93172396	6 PK 1990	950354	AVX 10 x 925
9121108	7 PK 1145	93172397	6 PK 1880	950355	AVX 10 x 875
9121113	7 PK 1793	93172398	6 PK 1880	950356	AVX 10 x 875
9128444	524UT	93175325	6 PK 1880	950357	AVX 10 x 1075
9128516	519ST	93178811	ZRK 1540	950357	AVX 10 x 1075 TM
9128656	519ST	93178812	ZRK 1466	950358	AVX 10 x 875
9128723	ZRK 1292	93178816	371ST	950359	AVX 10 x 1075
9128725	ZRK 1023	93179102	6 PK 1055	950359	AVX 10 x 1075 TM
9128736	509UT	93180563	7 PK 1920	950360	AVX 10 x 875
9128739	506UT	93180815	ZRK 1455	950362	AVX 10 x 825
9128740	507UT	93181138	6 PK 1055	950363	AVX 10 x 763
9128741	504UT	93181196	6 PK 1413	950364	AVX 10 x 813
9128952	5 PK 1210	93181316	5 PK 1210	950365	AVX 10 x 800
9129060	ZRK 1026	93181317	5 PK 1210	950366	AVX 10 x 950
9129460	5 PK 1230	93181710	6 PK 1800	950367	AVX 10 x 813



Teilenummer Part number	Abmessung Dimension
----------------------------	------------------------

**OPEL**

950371	AVX 10 x 813
950373	AVX 13 x 1450
950375	AVX 13 x 1450
96413861	ZRK 1026
96440421	6 PK 2065
96628779	6 PK 2404
96628792	6 PK 1890
97016326	ZRK 1235
97046326	ZRK 1235
97065986	ZRK 1097
97074109	AVX 13 x 915
97112438	520ST
97114552	520ST
97130560	6 PK 2285
97130561	6 PK 2040
97143724	ZRK 1431
97186395	6 PK 1250
97186396	6 PK 1590
97229071	6 PK 1590
97232826	6 PK 1625
97232875	6 PK 1275
97232876	6 PK 1625
97324297	6 PK 1600
97350979	6 PK 1920
97355691	6 PK 1605
97385845	6 PK 1250
97385846	6 PK 1610
97714044	AVX 13 x 1450
98000023	6 PK 1590
98007135	6 PK 1605
98010045	6 PK 1600
98010046	6 PK 1625

**PERKINS**

2614A015	AVX 10 x 775
2614A031	AVX 10 x 975
2614A053	AVX 10 x 1250
2614B540	AVX 13 x 1150
2614B540	AVX 13 x 1150 TM
2614B542	AVX 13 x 1175
2614B542	AVX 13 x 1175 TM
2614B544	AVX 13 x 1200
2614B544	AVX 13 x 1200 TM
2614B550	AVX 13 x 1275
2614B550	AVX 13 x 1275 TM
2614B552	AVX 13 x 1300
2614B552	AVX 13 x 1300 TM
2614B553	AVX 13 x 1312
2614B554	AVX 13 x 1325
2614B554	AVX 13 x 1325 TM
2614B556	AVX 13 x 1350 TM
2614B558	AVX 13 x 1375
2614B558	AVX 13 x 1375 TM
2614B560	AVX 13 x 1400 TM
2614B562	AVX 13 x 1425
2614B562	AVX 13 x 1425 TM
2614B570	AVX 13 x 1525
2614B588	AVX 13 x 1500
2614B588	AVX 13 x 1500 TM
2614B658	2/AVX 13 x 1350
2614B840	AVX 13 x 1150
2614B840	AVX 13 x 1150 TM
2614B844	AVX 13 x 1200
2614B844	AVX 13 x 1200 TM
2614B852	AVX 13 x 1300

Teilenummer Part number	Abmessung Dimension
----------------------------	------------------------

**PERKINS**

2614B852	AVX 13 x 1300 TM
2614B853	AVX 13 x 1312
2614B856	AVX 13 x 1350 TM
2614B858	AVX 13 x 1375
2614B858	AVX 13 x 1375 TM
2614B864	AVX 13 x 1450
2614B864	AVX 13 x 1450 TM
2614B958	2/AVX 13 x 1350
2614B968	AVX 13 x 1500
2614B968	AVX 13 x 1500 TM
2614B970	AVX 13 x 1525

**PEUGEOT**

0000128119	551UR
051361	281ST
0816.89	ZRK 1703
0816.A0	ZRK 1703
081616	ZRK 1051
081619	ZRK 1267
081622	ZRK 1262
081624	ZRK 1125
081629	ZRK 1125
081631	ZRK 1129
081632	ZRK 1131
081633	ZRK 1096
081634	ZRK 1274
081636	ZRK 1114
081637	ZRK 1118
081640	ZRK 1137
081642	ZRK 1114
081644	ZRK 1118
081646	ZRK 1262
081648	ZRK 1128
081653	ZRK 1143
081654	ZRK 1144
081655	ZRK 1110
081656	ZRK 1114
081658	ZRK 1262
081660	ZRK 1128
081662	ZRK 1128
081663	ZRK 1254
081664	ZRK 1142
081665	ZRK 1138
081667	ZRK 1125
081668	ZRK 1141
081669	ZRK 1127
081671	ZRK 1128
081672	ZRK 1262
081673	ZRK 1029
081679	ZRK 1244
081685	ZRK 1537
081686	ZRK 1457
081688	ZRK 1078
081693	ZRK 1351
081696	ZRK 1352
081698	ZRK 1029
081699	ZRK 1312
0816A1	ZRK 1149
0816A3	ZRK 1316
0816A4	ZRK 1332
0816A6	ZRK 1445
0816A8	ZRK 1352
0816A9	ZRK 1352
0816C1	ZRK 1078
0816C2	ZRK 1149

Teilenummer Part number	Abmessung Dimension
----------------------------	------------------------

**PEUGEOT**

0816C8	ZRK 1068
0816E0	ZRK 1537
0816E4	ZRK 1441
0816E5	ZRK 1312
0816E6	ZRK 1441
0816F0	ZRK 1467
0816F2	ZRK 1457
0816F4	ZRK 1149
0816F7	ZRK 1453
0816G1	ZRK 1456
0816G3	ZRK 1452
0816G4	ZRK 1588
0816G7	ZRK 1460
0816G8	ZRK 1705
0816H3	ZRK 1703
0816H5	ZRK 1705
0816H6	ZRK 1537
0816H7	ZRK 1537
0816J5	ZRK 1575
081817	289UT
081819	275ST
081820	279ST
081821	350ST
081823	359UT
081824	357ST
082053	252ST
082910	180ST
082911	284ST
082912	256ST
082917	350ST
082919	252ST
082920	260ST
082921	284ST
082922	270ST
082930	254ST
082931	273ST
082932	283ST
082933	274ST
082935	283ST
082942	260ST
082943	270ST
082945	254ST
082946	273ST
082949	227UT
082952	240ST
082954	252ST
082960	250UT
082961	250UT
082962	250UT
082963	250UT
082966	294ST
082967	294ST
082969	239ST
082974	240ST
082976	294ST
082977	294ST
082978	239ST
082979	239ST
082982	226ST
082988	331ST
082989	331ST
082990	345ST
082992	294ST
082993	294ST
082996	294ST



Teilenummer Part number	Abmessung Dimension	Teilenummer Part number	Abmessung Dimension	Teilenummer Part number	Abmessung Dimension
<b>PEUGEOT</b>		<b>PEUGEOT</b>		<b>PEUGEOT</b>	
0829A0	333ST	083157	KT 1309	128026	4 PK 950
0829A1	334UT	083158	KT 1433	128035	6 PK 894
0829A3	447ST	083159	KT 1433	128037	4 PK 900
0829A4	447ST	083160	KT 1350	128040	3 PK 945
0829A7	294ST	083161	KT 1350	128043	6 PK 894
0829C7	226ST	083162	KT 1327	128045	6 PK 913
0829C8	333ST	083163	KT 1310	128046	6 PK 995
083002	262UT	083165	KT 1244	128048	6 PK 950
083011	255UT	083166	KT 1244	128050	6 PK 950
083012	280UT	083167	KT 1309	128057	5 PK 1390
083013	277UT	083168	KT 1309	128058	5 PK 1450
083014	255UT	083173	KT 1351	128065	6 PK 950
083016	255UT	083174	KT 1351	128066	6 PK 913
083020	225UT	083176	KT 1373	128117	268SR
083023	241UT	083177	KT 1373	128118	552UR
083028	293UT	083178	KT 1518	128119	551UR
083029	293UT	083179	KT 1518	128139	552UR
083030	293UT	083180	KT 1328	26207509	350ST
083031	293UT	083181	KT 1328	400308	AVX 10 x 913
083032	357ST	083182	KT 1327	400313	AVX 10 x 913
083036	255UT	083183	KT 1327	400325	AVX 10 x 913
083037	255UT	083184	KT 1398	400332	AVX 10 x 1050
083040	359UT	083185	KT 1398	400365	AVX 10 x 800
083042	295UT	083186	KT 1370	400366	AVX 10 x 775
083044	241UT	083187	KT 1370	400381	AVX 10 x 813
083046	384UT	083188	KT 1244	400387	AVX 10 x 613
083048	332UT	083189	KT 1244	400398	AVX 10 x 850
083049	332UT	083190	KT 1353	400720	AVX 10 x 1300
083051	448UT	083192	KT 1428	400721	AVX 10 x 1215
083061	225UT	0831K6	KT 1415	400735	AVX 10 x 1225
083062	334UT	0831K8	KT 1417	400799	5 PK 880
083063	384UT	0831L0	KT 1331	400906	AVX 10 x 1025
083072	448UT	0831L2	KT 1332	400914	AVX 10 x 913
083074	448UT	0831L4	KT 1521	400922	AVX 10 x 650
083101	KT 1057	0831L6	KT 1330	400931	AVX 10 x 550
083102	KT 1013	0831L7	KT 1330	400941	4 PK 635
083103	KT 1019	0831N2	KT 1433	400942	4 PK 1030
083104	KT 1058	0831N3	KT 1433	400972	4 PK 635
083106	KT 1068	0831N4	KT 1518	400978	4 PK 635
083108	KT 1162	0831P1	KT 1390	400986	4 PK 1030
083111	KT 1070	0831Q3	KT 1013	456902	AVX 10 x 625
083113	KT 1013	0831Q4	KT 1019	456903	AVX 10 x 700
083114	KT 1019	0831R8	KT 1327	456904	AVX 10 x 650
083117	KT 1068	0831S2	KT 1351	456907	AVX 10 x 740
083124	KT 1063	0831S7	KT 1309	456908	AVX 10 x 650
083127	KT 1040	0831T4	KT 1244	456909	AVX 10 x 600
083132	KT 1216	0831T9	KT 1331	456911	AVX 10 x 617
083133	KT 1216	0831V0	KT 1521	456912	AVX 10 x 550
083134	KT 1522	128001	AVX 10 x 888	456914	AVX 10 x 600
083135	KT 1522	128002	AVX 10 x 1025	456915	AVX 10 x 613
083136	KT 1083	128003	AVX 10 x 1140	5000037891	AVP 13 x 2050 TM
083140	KT 1327	128003	AVX 10 x 1150	5003344281	5 PK 1104
083141	KT 1327	128004	AVX 10 x 1110	500345344	6 PK 913
083144	KT 1058	128005	AVX 10 x 1125	505732	AVX 10 x 900
083145	KT 1058	128006	AVX 10 x 1200	5489380	269SR
083146	KT 1084	128007	AVX 10 x 1125	5490590	282SR
083147	KT 1084	128012	AVX 10 x 825	5491190	269SR
083148	KT 1216	128014	AVX 10 x 1000	574046	AVX 10 x 888
083149	KT 1216	128015	AVX 10 x 775	574090	AVX 10 x 750
083150	KT 1071	128017	5 PK 1390	574527	AVX 13 x 1075
083151	KT 1071	128018	5 PK 1450	574901	AVX 10 x 600
083152	KT 1070	128019	5 PK 925	574902	AVX 10 x 613
083153	KT 1070	128023	5 PK 1390	574904	AVX 10 x 650
083155	KT 1244	128024	5 PK 1450	574905	AVX 10 x 650
083156	KT 1309	128025	4 PK 870	574908	AVX 10 x 700



Teilenummer Part number	Abmessung Dimension
----------------------------	------------------------

Teilenummer Part number	Abmessung Dimension
----------------------------	------------------------

Teilenummer Part number	Abmessung Dimension
----------------------------	------------------------

## PEUGEOT

## PEUGEOT

## PEUGEOT

574909	AVX 10 x 725
574910	AVX 10 x 725
574911	AVX 10 x 750
574912	AVX 10 x 785
574913	AVX 10 x 775
574914	AVX 10 x 800
574915	AVX 10 x 813
574918	AVX 10 x 850
574919	AVX 10 x 888
574921	AVX 10 x 913
574922	AVX 10 x 925
574924	AVX 10 x 938
574924	AVX 10 x 940
574928	AVX 10 x 1000
574929	AVX 10 x 1025
574930	AVX 10 x 1050
574932	AVX 10 x 1125
574933	AVX 10 x 1140
574934	AVX 10 x 1175
574935	AVX 10 x 1200
575004	AVX 10 x 1175
575011	AVX 10 x 1100
575012	AVX 10 x 935
575012	AVX 10 x 938
575012	AVX 10 x 940
575013	AVX 10 x 1150
575014	AVX 10 x 960
575014	AVX 10 x 965
575015	AVX 10 x 1215
575016	AVX 10 x 1100
575016	AVX 10 x 1110
575017	AVX 10 x 950
575018	AVX 10 x 700
575019	AVX 10 x 1175
575020	AVX 10 x 1000
575022	AVX 10 x 1110
575026	AVX 10 x 875
575028	AVX 10 x 675
575028	AVX 10 x 685
575029	AVX 10 x 900
575030	AVX 10 x 750
575031	AVX 10 x 1090
575031	AVX 10 x 1100
575032	AVX 10 x 900
575035	AVX 10 x 1000
575036	AVX 10 x 750
575037	AVX 10 x 775
575037	AVX 10 x 785
575040	AVX 10 x 725
575042	AVX 10 x 1000
575044	AVX 10 x 750
575046	AVX 10 x 735
575049	AVX 10 x 1100
575051	AVX 10 x 750
575052	AVX 10 x 925
575053	AVX 10 x 700
575054	AVX 10 x 1175
575055	4 PK 698
575056	4 PK 970
575058	AVX 10 x 938
575058	AVX 10 x 940
575060	AVX 10 x 750
575061	AVX 10 x 850
575062	4 PK 985
575063	AVX 10 x 925

575066	4 PK 1218
575069	4 PK 715
575070	4 PK 954
575072	AVX 10 x 1050
575073	AVX 10 x 710
575074	5 PK 725
575075	5 PK 1015
575076	4 PK 795
575077	5 PK 715
575078	4 PK 1230
575079	5 PK 970
575080	4 PK 855
575081	5 PK 1230
575082	AVX 10 x 675
575083	5 PK 698
575084	5 PK 1270
575085	5 PK 850
575086	5 PK 698
575087	5 PK 1140
575088	5 PK 710
575089	5 PK 1125
575090	AVX 10 x 775
575091	5 PK 1165
575092	5 PK 735
575094	4 PK 715
575095	5 PK 1025
575096	6 PK 1700
575097	6 PK 698
575098	6 PK 1070
5750A0	6 PK 1100
5750A1	6 PK 1660
5750A2	6 PK 1078
5750A5	6 PK 698
5750A6	6 PK 1130
5750C0	5 PK 1155
5750C1	6 PK 1175
5750C2	5 PK 1025
5750C3	6 PK 730
5750C4	5 PK 850
5750C7	5 PK 805
5750C8	5 PK 1255
5750C9	6 PK 1145
5750D0	5 PK 1190
5750D2	5 PK 715
5750D4	5 PK 1165
5750D7	5 PK 698
5750E6	6 PK 913
5750E7	6 PK 800
5750E8	6 PK 1010
5750E9	6 PK 1145
5750EJ	6 PK 1580
5750EN	6 PK 1390
5750EX	6 PK 1440
5750F0	6 PK 1700
5750FA	6 PK 1725
5750FH	6 PK 1205
5750FK	6 PK 1190
5750FN	6 PK 870
5750FP	6 PK 1153
5750FQ	5 PK 1219
5750FS	6 PK 800
5750FV	6 PK 975
5750FX	6 PK 1345
5750FY	6 PK 1710
5750GG	6 PK 1185

5750GL	6 PK 1740
5750GN	6 PK 1125
5750GP	6 PK 1390
5750GR	6 PK 1695
5750GW	6 PK 1145
5750GX	6 PK 1153
5750GY	6 PK 1560
5750HG	6 PK 1748
5750J9	6 PK 1700
5750K0	6 PK 1145
5750K2	5 PK 775
5750K4	5 PK 962
5750K6	6 PK 1863
5750K7	6 PK 1863
5750K9	6 PK 1115
5750KR	6 PK 1675
5750KX	6 PK 1560
5750KZ	6 PK 1470
5750L1	6 PK 1740
5750L3	6 PK 1153
5750L7	4 PK 1030
5750L9	6 PK 1165
5750LC	6 PK 730
5750LE	6 PK 1215
5750LG	6 PK 1710
5750M0	6 PK 1205
5750M1	6 PK 1605
5750M3	6 PK 1190
5750M4	6 PK 1105
5750M6	6 PK 1725
5750P0	4 PK 755
5750P5	5 PK 715
5750P7	5 PK 1030
5750P9	5 PK 775
5750PL	6 PK 1055
5750PP	6 PK 1070
5750PR	6 PK 1565
5750PS	6 PK 1885
5750PV	6 PK 730
5750Q1	5 PK 1055
5750Q5	6 PK 1605
5750QE	6 PK 1675
5750QG	6 PK 962
5750QJ	6 PK 850
5750QL	6 PK 1210
5750QP	6 PK 1000
5750QQ	6 PK 870
5750QS	6 PK 1185
5750QW	6 PK 1590
5750R6	6 PK 1751
5750R7	6 PK 1600
5750RC	6 PK 1215
5750RG	6 PK 906
5750RH	6 PK 1700
5750RQ	6 PK 1710
5750RS	6 PK 1165
5750RT	6 PK 1165
5750RV	6 EPK 1090
5750RW	6 EPK 1090
5750RX	6 PK 1352
5750RZ	6 PK 1205
5750S0	6 PK 1740
5750S1	6 PK 865
5750S3	6 PK 1025
5750S5	6 PK 1390



Teilenummer Part number	Abmessung Dimension	Teilenummer Part number	Abmessung Dimension	Teilenummer Part number	Abmessung Dimension
<b>PEUGEOT</b>		<b>PEUGEOT</b>		<b>PEUGEOT</b>	
5750S7	6 PK 1735	5750XR	6 PK 1710	75491923	268SR
5750S9	6 PK 1605	5750XS	6 PK 1740	75515868	268SR
5750SA	6 EPK 780	5750XW	6 PK 1045	7618111	5 PK 925
5750SG	6 PK 1195	5750XZ	6 PK 865	816A6	ZRK 1445
5750SQ	4 PK 698	5750Y0	6 PK 1390	91508298	256ST
5750SS	4 PK 954	5750Y1	6 PK 1390	9151357980	ZRK 1125
5750SY	5 PK 1140	5750Y5	6 PK 1710	91516768	4 PK 841
5750SZ	5 PK 710	5750Y6	6 PK 1390	9151772280	ZRK 1125
5750T1	6 PK 1450	5750YC	6 PK 1450	91538722	260ST
5750T2	6 PK 1010	5750YE	6 PK 1565	91541144	5 PK 725
5750T3	6 PK 1565	5750YG	6 PK 1751	91541175	5 PK 725
5750T5	6 PK 1470	5750YH	6 PK 1670	9301036280	ZRK 1262
5750T7	6 PK 1740	5750YK	6 EPK 780	93501404	284ST
5750T9	6 PK 1751	5750YL	6 EPK 1090	93501405	262UT
5750TA	5 PK 1125	5750YL	6 PK 1590	93510847	263SR
5750TE	6 PK 1070	5750YP	6 PK 800	9400816589	ZRK 1262
5750TF	6 PK 1100	5750YQ	6 PK 975	95006057	271UR
5750TG	6 PK 1660	5750YX	6 PK 1245	95495830	289UT
5750TH	6 PK 1078	5750Z0	6 PK 1450	95577540	289UT
5750TJ	6 PK 698	5750Z2	6 PK 1565	95590353	257SK
5750TL	5 PK 1155	5750Z4	6 PK 1735	95619217	350ST
5750TP	6 PK 730	5750Z6	6 PK 1751	95640195	254ST
5750TV	5 PK 1190	5750Z8	6 PK 1440	96001122	4 PK 698
5750TX	5 PK 690	5750ZF	6 PK 800	96004619	253SR
5750VC	6 PK 1145	575108	553UR	96010657	270ST
5750VH	6 PK 1205	575111	553UR	96012051	4 PK 813
5750VL	6 PK 800	575112	271UR	96014397	5 PK 1270
5750VN	6 PK 975	575114	553UR	96019295	4 PK 855
5750VP	6 PK 1345	575115	251SR	96021925	5 PK 698
5750VQ	6 PK 1710	575118	278SR	96036288	551UR
5750VR	6 PK 1185	575126	276SR	9603879880	ZRK 1118
5750VS	6 PK 1740	575138	251SR	96046092	5 PK 850
5750VT	6 PK 1125	575147	554UT	96046099	4 PK 635
5750VV	6 PK 1145	575184	554UT	96046101	5 PK 1390
5750VX	6 PK 1748	575191	554UT	9605062	4 PK 1030
5750VZ	6 PK 1145	5755018	AVX 10 x 700	96050625	4 PK 1030
5750W1	6 PK 1045	575753	AVX 13 x 1000	9605284780	ZRK 1138
5750W5	6 PK 1205	645355	AVX 13 x 900	960547	AVX 10 x 550
5750W6	6 PK 1725	645377	4 PK 841	96054790	AVX 10 x 550
5750W7	6 PK 750	6453A0	4 PK 1020	96056183	275ST
5750W8	5 PK 775	6453AF	5 PK 1025	96059324	5 PK 710
5750WE	6 PK 1863	6453C5	253SR	96059541	5 PK 1450
5750WG	6 PK 1560	6453C6	263SR	96074514	251SR
5750WH	6 PK 1470	6453CT	5 PK 1104	96076190	552UR
5750WJ	6 PK 1153	6453CZ	5 PK 1030	96081660	ZRK 1128
5750WL	6 PK 1165	6453E5	4 PK 813	96088591	278SR
5750WN	6 PK 730	6453FJ	5 PK 1104	96094102	280UT
5750WP	6 PK 1710	6453G4	253SR	96097691	281ST
5750WQ	6 PK 1605	6453L2	4 PK 841	96098279	279ST
5750WV	5 PK 715	6453NY	5 PK 1104	96099089	255UT
5750WY	6 PK 1055	6453TT	4 EPK 1102	96100168	ZRK 1128
5750WZ	6 PK 1070	6453TV	5 PK 1025	96106737	4 PK 715
5750X0	6 PK 865	6453W1	6 PK 925	96112418	253SR
5750X1	6 PK 1025	645592	AVX 13 x 1350	96112753	553UR
5750X2	6 PK 1390	6455B2	4 PK 962	96120257	6 PK 913
5750X3	6 PK 1735	645627	AVX 13 x 1350	96124532	4 PK 715
5750X9	6 PK 1470	645641	AVX 13 x 1375	96135989	4 PK 950
5750XA	6 PK 1565	645701	AVX 13 x 900	96137001	273ST
5750XC	6 PK 1885	645725	AVX 13 x 1350	96140606	6 PK 1863
5750XE	5 PK 1055	645752	AVX 13 x 900	9614252580	ZRK 1262
5750XF	6 PK 962	645753	AVX 13 x 1000	96142597	ZRK 1262
5750XG	6 PK 1000	645782	AVX 13 x 900	96142840	6 PK 698
5750XJ	6 PK 1185	6543CH	5 PK 1080	96144507	6 PK 730
5750XK	6 PK 1590	7081671	ZRK 1128	96144514	6 PK 1175
5750XN	6 PK 1215	7081671114X1	ZRK 1128	96146660	553UR





Teilenummer Part number	Abmessung Dimension
----------------------------	------------------------

Teilenummer Part number	Abmessung Dimension
----------------------------	------------------------

Teilenummer Part number	Abmessung Dimension
----------------------------	------------------------

**PEUGEOT**

96147542	5 PK 1025
96152078	6 PK 1660
96152079	6 PK 1660
96152083	6 PK 1070
96152085	6 PK 1078
96152089	6 PK 1100
96155010	6 PK 1010
96155951	6 PK 1700
96156400	276SR
96159233	277UT
96161329	5 PK 850
9616341080	5 PK 690
96165809	5 PK 962
96165811	5 PK 775
96171886	274ST
9617800980	225UT
96180219	6 PK 1145
96180220	6 PK 1145
96188881	6 PK 1740
96192361	241UT
96197629	ZRK 1537
96201309	255UT
9620409980	ZRK 1262
96205509	6 PK 1605
96209042	6 PK 730
9621203380	227UT
9622313180	ZRK 1351
9622315380	ZRK 1351
96225744	283ST
96235499	6 PK 1105
96236849	6 PK 1165
96236952	6 PK 1605
96245972	3 PK 866
96251516	6 PK 1605
9626157480	ZRK 1352
96273679	5 PK 715
96273681	5 PK 775
96278607	251SR
96278805	240ST
96289902	554UT
9629082280	ZRK 1352
96296777	250UT
96308935	6 PK 1751
9631203080	ZRK 1457
96313338	6 PK 1740
96316038	6 PK 1565
96317187	6 PK 1725
96327221	295UT
96334782	6 PK 1470
9633713380	ZRK 1467
96337272	6 PK 1450
9634087880	225UT
9634106180	ZRK 1456
9634740180	ZRK 1456
96350076	ZRK 1149
96353368	239ST
9635438380	ZRK 1068
96370580	239ST
9637240580	ZRK 1149
96374926	226ST
9637492680	226ST
96375140	ZRK 1445
96375295	6 PK 1440
96378749	294ST
9637914380	ZRK 1537

**PEUGEOT**

9638115380	250UT
9638355980	ZRK 1453
96398222	294ST
9639842180	ZRK 1537
96403456	294ST
9640379480	6 PK 1153
9640419580	ZRK 1453
9640669280	ZRK 1441
9640810680	ZRK 1441
9640828480	447ST
9640828680	ZRK 1452
96410695	6 PK 1190
96410697	6 PK 1205
96413140	331ST
96415393	332UT
96417058	6 PK 1710
96420067	554UT
9642006780	554UT
96420439	6 PK 1725
9642383880	6 PK 1710
9642458680	6 PK 730
96429298	345ST
96433296	294ST
9644258480	448UT
9645717480	ZRK 1460
9645717580	ZRK 1460
9646864480	ZRK 1705
9647367480	ZRK 1588
9648473280	334UT
9648704380	333ST
9650686080	6 PK 1215
965114480	6 PK 1710
9651764880	6 PK 1710
9653204380	6 PK 1000
9653226080	ZRK 1441
9653226280	ZRK 1441
9655279280	6 PK 1205
9655945780	6 PK 1215
9661728880	6 EPK 1090
9663100880	6 EPK 780
9663101080	6 EPK 1090
96654092	275ST
96817523	6 PK 1245
9681752380	6 PK 1245
9682237380	6 PK 975
9682305780	448UT
97518683	4 PK 1020
97522886	252ST
97535002	252ST
98485800	5 PK 1080
98487322	6 PK 894

**PLYMOUTH**

4298114	4 PK 1050
---------	-----------

**POLMO**

066111	ZRK 1380
4153752	AVX 10 x 950

**PONTIAC**

24508560	6 PK 1760
24573322	5 PK 1140

**PORSCHE**

047260849	AVX 13 x 900
-----------	--------------

**PORSCHE**

047260849A	AVX 13 x 875
047903137	AVX 10 x 900
047903137A	AVX 10 x 900
048260849	AVX 13 x 900
056109119A	ZRK 1056
19201350	AVX 10 x 710
9001920050	AVX 10 x 975
90019200550	AVX 10 x 975
90019201350	AVX 13 x 1100
90019202050	AVX 10 x 1025
90019202150	AVX 10 x 950
90019202650	AVX 13 x 1125
90019202750	AVX 13 x 1100
92312612800	AVX 13 x 1025
92810535100	458UT
92810551212	456ST
92810557102	457UT
92810557104	465UT
93012621600	308UT
93310616100	AVX 10 x 710
94410202507	451ST
94410221902	ZRK 1298
94410221904	ZRK 1298
94410227704	453UT
94410227706	453UT
94410502704	463UT
94410513703	ZRK 1130
94410515704	ZRK 1130
94410524103	455UT
94410527302	450UT
94410563104	454ST
94410563105	462ST
94410563110	462ST
95510293400	6 PK 2475
98010225102	5 PK 1270
9919200650	AVX 10 x 825
99610215164	6 PK 2115
99610215165	6 PK 1930
99610215166	6 PK 2115
99610215193	6 PK 2260
99913230550	AVX 13 x 1125
99919200550	AVX 10 x 975
99919200650	AVX 10 x 825
99919200950	AVX 10 x 700
99919201850	AVX 10 x 925
99919202050	AVX 10 x 900
99919209750	AVX 10 x 725
99919209850	AVX 10 x 725
99919211750	AVX 13 x 1050
99919212350	AVX 10 x 875
99919212750	AVX 13 x 1025
99919212850	AVX 13 x 975
99919212950	AVX 13 x 1050
99919213550	AVX 10 x 875
99919214650	AVX 13 x 1075
99919215450	AVX 10 x 1050
99919216150	AVX 13 x 1050
99919217350	AVX 13 x 1200
99919217650	AVX 10 x 715
99919217750	AVX 10 x 1050
99919219350	AVX 10 x 875
99919220050	AVX 10 x 888
99919220450	5 PK 735
99919220650	5 PK 1005
99919220750	5 PK 1000



Teilenummer Part number	Abmessung Dimension
----------------------------	------------------------

Teilenummer Part number	Abmessung Dimension
----------------------------	------------------------

Teilenummer Part number	Abmessung Dimension
----------------------------	------------------------

**PORSCHE**

99919221450	4 PK 860
99919223650	AVX 10 x 950
99919224150	AVX 10 x 950
99919225450	AVX 13 x 1150
99919225550	AVX 13 x 1200
99919225950	5 PK 886
99919226650	6 PK 858
99919226950	6 PK 858
99919227650	AVX 13 x 1055
99919227650A	AVX 13 x 1055
99919227750	AVX 10 x 685
99919227850	AVX 10 x 700
99919228250	6 PK 720
99919228350	6 PK 1000
99919228450	6 PK 720
99919228550	6 PK 1000
99919229050	6 PK 720
99919229150	6 PK 1000
99919229350	AVX 13 x 1030
99919229350A	AVX 13 x 1030
99919229450	AVX 10 x 740
99919229550	6 PK 1000
99919229950	6 PK 1000
99919230550	AVX 13 x 1125
99919230650	AVX 13 x 950
99919230750	AVX 10 x 685
99919230750A	AVX 10 x 685
99919230850	AVX 10 x 695
99919230850A	AVX 10 x 695
99919232950	AVX 10 x 775
99919233550	AVX 13 x 1075
99919233850	AVX 10 x 775
99919234350	AVX 10 x 763
99919234750	6 PK 870
99919235250	AVX 13 x 1075
99919235250	AVX 13 x 1075 TM
99919236350	AVX 13 x 1075
99919236550	6 PK 1555
99919237250	AVX 10 x 763
99919237950	6 PK 2285
9991924850	AVX 13 x 1125
99919253650	6 PK 1413

**PROTON**

145813	ZRK 1156
MB288838	AVX 13 x 625
MD069671	4 PK 870
MD106658	4 PK 870
MD118572	4 PK 875
MD145813	ZRK 1156
MD171373	4 PK 780
MD176386	ZRK 1207
MD180574	4 PK 763
MD183556	4 PK 763
MD186111	4 PK 635
MD192319	ZRK 1198
MD192809	5 PK 950
MD303288	4 PK 595
MD314778	4 PK 595
PW502943	4 PK 870
PW510580	4 PK 870
PW510942	5 PK 950
PW510943	4 PK 780
PW510944	4 PK 595
PW850769	4 PK 595

**RENAULT**

0000323580	AVX 13 x 1450 TM
0000323786	AVX 13 x 1450
0000323786	AVX 13 x 1450 TM
0000323804	AVX 13 x 1525
0000323804	AVX 13 x 1525 TM
0000323948	AVX 13 x 1450 TM
0023223065	2-AVX 13 x 1500 TM
0023223078	AVX 13 x 1100
0023223078	AVX 13 x 1100 TM
0023223091	AVX 13 x 900
0023223091	AVX 13 x 900 TM
0023223097	AVX 10 x 1300
0023223131	AVX 13 x 1300
0023223131	AVX 13 x 1300 TM
0023223139	AVX 13 x 925
0023223139	AVX 13 x 925 TM
0023223140	AVX 13 x 1275
0023223140	AVX 13 x 1275 TM
0023223142	AVX 13 x 1475
0023223142	AVX 13 x 1475 TM
0023223143	AVX 13 x 1100
0023223148	AVX 13 x 1675 TM
0023223148	AVX 13 x 1700
0023223154	AVX 13 x 1450
0023223154	AVX 13 x 1450 TM
0023223156	AVX 10 x 913
0023223157	AVX 10 x 975
0038445003	AVX 13 x 1600
0038445003	AVX 13 x 1600 TM
0921232003	AVX 13 x 800
0921232003	AVX 13 x 800 TM
0921232005	AVX 13 x 850
119202Y501	6 PK 1105
1195031U02	4 PK 775
130C11321R	KT 1409
2521227360	6 PK 1515
323561	AVX 13 x 1525 TM
323580	AVX 13 x 1450
323580	AVX 13 x 1450 TM
323948	AVX 13 x 1450
323948	AVX 13 x 1450 TM
5000020188	AVX 13 x 1400
5000020189	AVX 13 x 1400
5000020190	AVX 13 x 1475
5000021655	AVX 13 x 1325
5000022632	AVX 13 x 1300
5000030114	AVX 13 x 1800
5000030307	AVX 13 x 1425
5000030848	AVX 13 x 1750
5000031149	AVX 13 x 1050
5000031150	AVX 13 x 1425
5000031369	AVX 13 x 1050
5000031483	AVX 13 x 1050
5000033012	AVX 13 x 1000
5000033043	AVX 13 x 850
5000033045	AVX 13 x 750
5000034802	AVX 10 x 990
5000035610	AVX 13 x 1200
5000044858	AVX 13 x 925
5000044858	AVX 13 x 925 TM
5000048933	AVX 13 x 1150
5000048933	AVX 13 x 1150 TM
5000049298	AVX 13 x 925
5000049298	AVX 13 x 925 TM
5000049619	AVX 13 x 1200

**RENAULT**

5000131716	AVX 10 x 750
5000133113	AVX 10 x 1225
5000136827	AVX 13 x 1025
5000136827	AVX 13 x 1025 TM
5000168027	AVX 13 x 1050
5000168027	AVX 13 x 1050 TM
5000168463	AVX 13 x 1425
5000168463	AVX 13 x 1425 TM
5000182327	AVX 10 x 975
5000182761	AVP 13 x 1950 TM
50001847819	ZRK 1316
5000240844	AVX 13 x 750
5000240844	AVX 13 x 750 TM
5000293612	ZRK 1316
5000552494	AVX 13 x 825
5000564556	AVX 13 x 1050
5000564556	AVX 13 x 1050 TM
5000566546	AVX 13 x 1350
5000566546	AVX 13 x 1350 TM
5000566547	AVX 13 x 1450
5000566547	AVX 13 x 1450 TM
5000592731	AVX 10 x 990
5000612768	AVX 10 x 950
5000625394	AVX 13 x 1425
5000625394	AVX 13 x 1425 TM
5000626261	AVX 13 x 1250
5000626261	AVX 13 x 1250 TM
5000659558	AVX 13 x 1075
5000659559	AVX 10 x 1125
5000659559	AVX 13 x 1075
5000659559	AVX 13 x 1075 TM
5000663786	AVX 10 x 1350
5000663787	AVX 13 x 1175
5000663787	AVX 13 x 1175 TM
5000663788	AVX 13 x 1500
5000666711	AVX 13 x 1200
5000666711	AVX 13 x 1200 TM
5000666879	AVX 13 x 1150
5000666879	AVX 13 x 1150 TM
5000666880	AVX 13 x 1175
5000666880	AVX 13 x 1175 TM
5000666883	AVX 13 x 1400
5000666883	AVX 13 x 1450
5000666883	AVX 13 x 1450 TM
5000666884	AVX 13 x 1450
5000666884	AVX 13 x 1450 TM
5000666889	AVX 10 x 875
5000666898	AVX 13 x 1225
5000666898	AVX 13 x 1225 TM
5000670601	AVX 13 x 1375
5000670601	AVX 13 x 1375 TM
5000670639	AVX 13 x 1600
5000670639	AVX 13 x 1600 TM
5000670641	AVX 13 x 1650
5000670641	AVX 13 x 1650 TM
5000670728	5 PK 1010 TM
5000678324	AVX 13 x 1350
5000678324	AVX 13 x 1350 TM
5000678543	6 PK 1245 TM
5000678605	5 PK 1540 TM
5000679653	6 PK 1755 TM
5000679654	8 PK 1560 TM
5000681349	AVX 13 x 1575
5000681349	AVX 13 x 1575 TM
5000681406	AVX 13 x 1650



Teilenummer Part number	Abmessung Dimension
----------------------------	------------------------

Teilenummer Part number	Abmessung Dimension
----------------------------	------------------------

Teilenummer Part number	Abmessung Dimension
----------------------------	------------------------

RENAULT	
---------	--

5000681406	AVX 13 x 1650 TM
5000681668	5 PK 886
5000686250	AVX 13 x 1425
5000686250	AVX 13 x 1425 TM
5000686251	AVX 13 x 1650
5000686251	AVX 13 x 1650 TM
5000686286	AVX 13 x 1450
5000686286	AVX 13 x 1450 TM
5000686366	AVX 13 x 1250
5000686366	AVX 13 x 1250 TM
5000686547	AVX 13 x 1175
5000686547	AVX 13 x 1175 TM
5000686548	AVX 13 x 1200
5000686548	AVX 13 x 1200 TM
5000686549	AVX 13 x 1525
5000686549	AVX 13 x 1525 TM
5000686684	9 PK 1200 TM
5000686750	9 PK 1290 TM
5000686828	AVX 13 x 1450
5000686828	AVX 13 x 1450 TM
5000686852	AVX 13 x 1425
5000686852	AVX 13 x 1425 TM
5000686855	AVX 13 x 1650
5000686855	AVX 13 x 1650 TM
5000686864	AVX 13 x 1350
5000686864	AVX 13 x 1350 TM
5000686893	AVX 13 x 1250
5000686893	AVX 13 x 1250 TM
5000686895	AVX 13 x 1225
5000686895	AVX 13 x 1225 TM
5000689151	AVX 13 x 1450
5000689151	AVX 13 x 1450 TM
5000689152	AVX 13 x 1450
5000689152	AVX 13 x 1450 TM
5000693021	6 PK 1660
5000693140	6 PK 1755 TM
5000785325	AVX 13 x 1200
5000785370	AVX 13 x 1350
5000785370	AVX 13 x 1350 TM
5000785475	AVX 10 x 1125
5000785652	AVX 10 x 913
5000786244	AVX 13 x 1425
5000786244	AVX 13 x 1425 TM
5000786244	AVX 13 x 1450
5000786244	AVX 13 x 1450 TM
5000786245	AVX 13 x 1475
5000786245	AVX 13 x 1475 TM
5000786246	AVX 13 x 1525
5000786246	AVX 13 x 1525 TM
5000786246	AVX 13 x 1550
5000786359	AVX 13 x 1550
5000786359	AVX 13 x 1550 TM
5000786360	AVX 13 x 1625
5000786360	AVX 13 x 1625 TM
5000786386	AVX 13 x 900
5000786386	AVX 13 x 900 TM
5000786386	AVX 13 x 925
5000786386	AVX 13 x 925 TM
5000786518	AVX 10 x 1350
5000786661	AVX 10 x 975
5000787170	AVX 13 x 1400
5000787170	AVX 13 x 1400 TM
5000787245	AVX 13 x 1475
5000787245	AVX 13 x 1475 TM
5000787519	AVX 13 x 1625

RENAULT	
---------	--

5000787519	AVX 13 x 1650
5000787519	AVX 13 x 1650 TM
5000787739	AVX 13 x 1525
5000787739	AVX 13 x 1550
5000787739	AVX 13 x 1550 TM
5000788119	AVX 10 x 913
5000788120	AVX 10 x 975
5000788121	AVX 10 x 1125
5000788122	AVX 10 x 1350
5000788123	AVX 13 x 1075
5000788123	AVX 13 x 1075 TM
5000788124	AVX 13 x 1175
5000788124	AVX 13 x 1175 TM
5000788125	AVX 13 x 1525
5000788125	AVX 13 x 1525 TM
5000788221	AVX 13 x 1225
5000788221	AVX 13 x 1250
5000788221	AVX 13 x 1250 TM
5000788222	AVX 13 x 1650
5000788483	AVX 10 x 1125
5000788662	AVX 10 x 975
5000788998	AVX 13 x 1700
5000788998	AVX 13 x 1700 TM
5000789707	AVX 13 x 1575
5000789707	AVX 13 x 1575 TM
5000789901	AVX 13 x 1125
5000789901	AVX 13 x 1125 TM
5000789953	AVX 13 x 1125
5000789953	AVX 13 x 1125 TM
5000789954	AVX 13 x 1550
5000789954	AVX 13 x 1550 TM
5000793149	AVX 13 x 1450
5000793150	AVX 13 x 1075
5000793150	AVX 13 x 1075 TM
5000793181	AVX 13 x 1175
5000793181	AVX 13 x 1175 TM
5000793182	AVX 13 x 1125
5000793182	AVX 13 x 1125 TM
5000814593	ZRK 1100
5000815440	ZRK 1102
5000816448	AVX 13 x 1125
5000816448	AVX 13 x 1125 TM
5000820749	AVX 13 x 1050
5000820749	AVX 13 x 1050 TM
5000820750	AVX 13 x 1425
5000820750	AVX 13 x 1425 TM
5000878606	AVX 13 x 1050
5000878606	AVX 13 x 1050 TM
5000878607	AVX 13 x 1375
5000878607	AVX 13 x 1375 TM
5000879339	AVX 13 x 1575
5000879339	AVX 13 x 1575 TM
5000879340	AVX 13 x 1775
5000879340	AVX 13 x 1775 TM
5000882120	AVX 13 x 950
5000882120	AVX 13 x 950 TM
5000954214	AVX 13 x 1625
5000954214	AVX 13 x 1625 TM
5000988950	AVX 13 x 1060 TM
5001001259	359UT
5001001267	ZRK 1100
5001001272	357ST
5001014471	AVX 13 x 1075
5001014471	AVX 13 x 1075 TM
5001014473	AVX 13 x 1175

RENAULT	
---------	--

5001014473	AVX 13 x 1175 TM
5001014573	AVX 13 x 1150
5001014573	AVX 13 x 1150 TM
5001014574	AVX 13 x 1450
5001014574	AVX 13 x 1450 TM
5001014848	AVX 13 x 1100
5001014848	AVX 13 x 1100 TM
5001822055	AVX 13 x 875
5001822055	AVX 13 x 875 TM
5001822405	AVX 13 x 1600
5001822405	AVX 13 x 1600 TM
5001822980	AVX 13 x 1600
5001822980	AVX 13 x 1600 TM
5001823624	AVX 13 x 1525
5001823624	AVX 13 x 1525 TM
5001836605	ZRK 1312
5001844336	AVX 13 x 1750
5001844336	AVX 13 x 1750 TM
500786245	AVX 13 x 1475
500786245	AVX 13 x 1475 TM
5010019725	AVX 13 x 1475
5010019725	AVX 13 x 1475 TM
5010095041	6 PK 1110 TM
5010128087	XPB 1500
5010222059	AVX 13 x 1825
5010222059	AVX 13 x 1825 TM
5010248035	6 PK 1080 TM
5010257794	AVX 13 x 1300
5010257794	AVX 13 x 1300 TM
5010284590	AVX 13 x 1500
5010284590	AVX 13 x 1500 TM
5010284890	AVX 13 x 1175
5010284890	AVX 13 x 1175 TM
5010284906	6 PK 1055
5010284916	4 PK 1015
5010295397	5 PK 1025 TM
5010295531	6 PK 1065 TM
5010330805	8 PK 1560 TM
5010330872	6 PK 1425 TM
5010359915	6 PK 1065 TM
5010359916	6 PK 1425 TM
5010412143	6 PK 1245 TM
5010437106	6 PK 1055
5010437130	AVX 13 x 1525
5010437130	AVX 13 x 1525 TM
5010437300	AVX 13 x 1050
5010437300	AVX 13 x 1050 TM
5010437301	AVX 13 x 1060 TM
5010437309	AVX 13 x 1060 TM
5010437598	6 PK 1055
5010437648	6 PK 1055
5010477334	5 PK 1025 TM
5010477336	5 PK 1045 TM
5010477337	5 PK 1240 TM
5010477766	6 PK 1395 TM
5010477837	5 PK 1045 TM
5010550411	5 PK 1260 TM
6000002810	AVX 10 x 675
6000003202	AVX 10 x 675
6000003312	AVX 10 x 675
6000068014	6 PK 825
6001008128	AVX 10 x 1200
6001548021	4 PK 715
6005000475	AVX 13 x 1275
6005000844	AVX 10 x 1050





Teilenummer Part number	Abmessung Dimension	Teilenummer Part number	Abmessung Dimension	Teilenummer Part number	Abmessung Dimension
<b>RENAULT</b>		<b>RENAULT</b>		<b>RENAULT</b>	
6005000927	AVX 13 x 1250	7700111671	5 PK 1750	7700503052	AVX 10 x 850
7420543484	8 PK 1435 TM	7700111761	ZRK 1075	7700523844	AVX 10 x 700
7420725537	8 PK 1515 TM	7700111822	346ST	7700525075	AVX 10 x 1200
7430638277	246ST	7700111983	ZRK 1195	7700525076	AVX 10 x 1225
7438610040	KT 1317	7700112528	ZRK 1327	7700532588	AVX 10 x 625
7438610041	KT 1118	7700112719	6 PK 1210	7700545221	AVX 10 x 825
7438630590	707UT	7700113061	ZRK 1103	7700546002	AVX 10 x 825
7438642251	246ST	7700113373	ZRK 1327	7700546003	AVX 10 x 825
7438670484	246ST	7700113558	ZRK 1470	7700546003	AVX 10 x 838
7439135036	708ST	7700113559	ZRK 1183	7700547324	AVX 10 x 650
7439135733	ZRK 1191	7700114127	ZRK 1436	7700549230	AVX 10 x 1225
7439146139	714UR	7700114235	6 PK 1660	7700557552	AVX 10 x 850
7439146376	707UT	7700114352	6 PK 1400	7700559731	AVX 10 x 700
7439146377	707UT	7700114635	6 PK 1125	7700565018	AVX 10 x 725
7439146899	6 PK 1240	7700114730	6 PK 1130	7700566951	AVX 10 x 838
7439146900	6 PK 1605	7700114860	167UT	7700567694	AVX 10 x 675
7439180954	ZRK 1191	7700115075	632ST	7700567695	AVX 10 x 650
7439440329	246ST	7700115862	298ST	7700579245	AVX 10 x 1075
7439440383	ZRK 1187	7700116047	ZRK 1069	7700579245	AVX 10 x 1075 TM
7700006809	AVX 10 x 1225	7700116049	603UT	7700580482	AVX 10 x 850
7700008695	AVX 10 x 1400	7700116050	611UT	7700580778	AVX 13 x 992
7700010200	AVX 13 x 1285	7700116054	299UT	7700585501	AVX 13 x 1025
7700013050	AVX 10 x 1375	7700116058	ZRK 1069	7700586110	AVX 10 x 613
7700019548	AVX 10 x 1425	7700116192	632ST	7700586110	AVX 10 x 625
7700037231	10 PK 1240 TM	7700260886	6 PK 1025	7700589404	AVX 10 x 700
7700062268	8 PK 1540 TM	7700260887	4 PK 1125	7700590371	AVX 13 x 1175
7700066723	8 PK 1956 TM	7700260889	6 PK 1240	7700614038	AVX 10 x 864
7700066725	8 PK 1940 TM	7700260891	621SR	7700618657	ZRK 1051
7700066739	8 PK 2605 TM	7700266794	616SR	7700619572	AVX 10 x 625
7700068151	4 PK 1015	7700267321	AVX 13 x 925	7700621031	AVX 10 x 700
7700068536	8 PK 1610 TM	7700267321	AVX 13 x 925 TM	7700621031	AVX 10 x 710
7700069032	8 PK 1560 TM	7700267464	5 PK 1330	7700624261	AVX 10 x 725
7700100119	ZRK 1522	7700267782	617ST	7700624262	AVX 10 x 850
7700100460	ZRK 1197	7700267935	616SR	7700624361	AVX 10 x 725
7700100531	ZRK 1183	7700267945	AVX 13 x 925	7700627033	AVX 10 x 813
7700100670	ZRK 1075	7700267945	AVX 13 x 925 TM	7700627459	AVX 10 x 1075
7700100671	632ST	7700268227	AVX 13 x 850	7700627459	AVX 10 x 1075 TM
7700101248	ZRK 1470	7700268229	AVX 10 x 625	7700630569	AVX 10 x 913
7700101261	6 PK 1751	7700268230	AVX 10 x 1250	7700632624	AVX 13 x 900
7700101474	6 PK 1400	7700268232	AVX 10 x 1250	7700632624	AVX 13 x 900 TM
7700101840	ZRK 1195	7700268238	AVX 10 x 1250	7700634518	AVX 10 x 1000
7700102047	ZRK 1103	7700268296	AVX 10 x 775	7700638898	AVX 11,9 x 758
7700103243	ZRK 1183	7700268754	AVX 10 x 1250	7700639484	AVX 10 x 1300
7700104596	ZRK 1195	7700271121	AVX 10 x 685	7700640354	AVX 10 x 975
7700105888	6 PK 1190	7700271122	AVX 10 x 725	7700644463	AVX 10 x 685
7700106241	ZRK 1103	7700271218	3 PK 775	7700646190	AVX 10 x 685
7700106243	ZRK 1183	7700271603	4 PK 1180	7700646222	AVX 10 x 825
7700107150	168UT	7700271618	609UR	7700646222	AVX 10 x 838
7700107175	6 PK 1751	7700271648	6 PK 1550	7700647366	AVX 10 x 1075
7700107249	631UT	7700272653	4 PK 1165	7700647366	AVX 10 x 1075 TM
7700107261	ZRK 1075	7700272741	6 PK 1550	7700647521	AVX 10 x 1013
7700107305	ZRK 1075	7700273010	4 PK 1260	7700648156	AVX 10 x 850
7700107493	5 PK 1110	7700273245	4 PK 1265	7700649825	AVX 10 x 775
7700107494	5 PK 1104	7700273277	630UT	7700649923	AVX 10 x 1075
7700108117	335ST	7700273279	ZRK 1317	7700649923	AVX 10 x 1075 TM
7700108148	5 PK 1125	7700273280	ZRK 1317	7700654664	AVX 10 x 613
7700108412	ZRK 1470	7700273611	ZRK 1317	7700654665	AVX 13 x 1015
7700108589	6 PK 1138	7700273650	ZRK 1317	7700654665	AVX 13 x 1015 TM
7700108626	242UT	7700300347	5 PK 1200	7700658289	AVX 10 x 1000
7700108920	167UT	7700300348	6 PK 858	7700658289	AVX 11,9 x 1010
7700109226	5 PK 1125	7700300614	6 PK 845	7700660586	614ST
7700109477	6 PK 1795	7700315600	6 PK 870	7700662412	AVX 10 x 700
7700109601	ZRK 1067	7700315601	6 PK 850	7700663010	AVX 10 x 1013
7700109632	ZRK 1067	7700332862	6 PK 1165	7700663157	AVX 13 x 825
7700110203	ZRK 1462	7700479118	AVX 11,9 x 758	7700663544	ZRK 1261



Teilenummer Part number	Abmessung Dimension
----------------------------	------------------------

Teilenummer Part number	Abmessung Dimension
----------------------------	------------------------

Teilenummer Part number	Abmessung Dimension
----------------------------	------------------------

RENAULT	
---------	--

7700663550	ZRK 1051
7700664248	AVX 10 x 1225
7700665224	625ST
7700666593	ZRK 1267
7700667399	AVX 10 x 1013
7700667399	AVX 11,9 x 1010
7700667586	AVX 13 x 865
7700670935	AVX 10 x 1225
7700673236	AVX 10 x 600
7700680398	AVX 10 x 1300
7700680399	AVX 10 x 1013
7700680399	AVX 11,9 x 1010
7700682388	AVX 10 x 800
7700682425	AVX 10 x 813
7700683283	AVX 10 x 825
7700683284	AVX 13 x 1050
7700685633	AVX 10 x 1140
7700690029	AVX 13 x 835
7700690965	AVX 10 x 1140
7700691465	AVX 13 x 1025
7700692315	180ST
7700692315	614ST
7700694741	AVX 11,9 x 1010
7700696055	ZRK 1101
7700696825	AVX 11,9 x 1010
7700696986	606ST
7700696987	607UT
7700697947	AVX 11,9 x 1183
7700699438	AVX 13 x 1025
7700704697	AVX 10 x 700
7700704698	AVX 10 x 710
7700704701	AVX 10 x 700
7700708337	607UT
7700708784	AVX 10 x 990
7700709398	4 PK 875
7700711047	ZRK 1101
7700717284	ZRK 1129
7700717899	4 PK 884
7700718260	AVX 13 x 725
7700718261	4 PK 884
7700718601	AVX 13 x 750
7700718725	ZRK 1129
7700718726	ZRK 1131
7700718752	ZRK 1133
7700718836	ZRK 1131
7700720082	AVX 13 x 875
7700720082	AVX 13 x 875 TM
7700720366	601ST
7700720452	5 PK 870
7700720582	AVX 11,9 x 1010
7700720780	5 PK 1165
7700721690	618UT
7700722452	625ST
7700722704	6 PK 1710
7700723964	6 PK 884
7700725577	ZRK 1276
7700726440	602ST
7700727166	ZRK 1147
7700729330	4 PK 875
7700729540	5 PK 850
7700729580	ZRK 1129
7700729751	6 PK 1175
7700729752	6 PK 1138
7700731717	AVX 10 x 1140
7700731718	AVX 10 x 1140

RENAULT	
---------	--

7700731789	AVX 10 x 1175
7700732795	AVX 10 x 1140
7700733489	611UT
7700733788	5 PK 886
7700734955	5 PK 886
7700735486	603UT
7700735904	6 PK 1695
7700735905	6 PK 1460
7700736085	600ST
7700736204	AVX 10 x 1000
7700736419	610ST
7700736969	ZRK 1106
7700738035	6 PK 1100
7700738783	6 PK 1413
7700740637	6 PK 1165
7700741506	ZRK 1276
7700742336	AVX 10 x 690
7700743548	6 PK 870
7700743549	6 PK 1175
7700743777	ZRK 1018
7700744380	6 PK 1165
7700744391	AVX 10 x 725
7700744961	5 PK 850
7700745215	614ST
7700745397	6 PK 1010
7700746125	AVX 11,9 x 1010
7700747381	6 PK 850
7700749104	AVX 10 x 1005
7700749115	AVX 11,9 x 758
7700749117	AVX 11,9 x 758
7700749225	ZRK 1145
7700749393	6 PK 900
7700850028	3 PK 815
7700850113	3 PK 715
7700850114	4 PK 1075
7700850603	604UR
7700850766	6 PK 1190
7700850789	605UR
7700851321	612SR
7700851954	6 PK 1550
7700852114	625ST
7700852410	608SR
7700853230	6 PK 1145
7700853242	613UR
7700853550	623UT
7700853616	6 PK 1190
7700853660	ZRK 1131
7700853838	3 PK 890
7700853862	ZRK 1261
7700853887	4 PK 1218
7700853990	4 PK 1218
7700854083	AVX 10 x 1250
7700854163	ZRK 1129
7700854326	4 PK 1065
7700854495	3 PK 890
7700855096	4 PK 1060
7700855098	6 PK 1740
7700856107	4 PK 735
7700856127	626UT
7700856351	ZRK 1131
7700856888	624SR
7700857065	6 PK 1165
7700857070	6 PK 1660
7700857071	6 PK 1432
7700857325	ZRK 1135

RENAULT	
---------	--

7700857879	627ST
7700858762	AVX 10 x 1150
7700859638	6 PK 1950
7700859639	6 PK 1010
7700859654	6 PK 1685
7700860463	6 PK 1642
7700860795	ZRK 1197
7700860833	5 PK 900
7700860897	ZRK 1204
7700861464	5 PK 655
7700861465	5 PK 775
7700861466	5 PK 1378
7700861467	4 PK 962
7700862173	5 PK 1260
7700862615	628UT
7700863095	ZRK 1103
7700863111	611UT
7700863112	603UT
7700863113	602ST
7700864019	5 PK 820
7700864813	6 PK 1153
7700865429	6 PK 1138
7700865588	5 PK 1515
7700866063	6 PK 1125
7700866437	3 PK 835
7700867939	5 PK 905
7700868273	5 PK 880
7700868878	6 PK 1125
7700869440	6 PK 894
7700869538	6 PK 1642
7700869685	4 PK 995
7700869686	4 PK 1237
7700869687	3 PK 1040
7700870367	4 PK 735
7700870896	4 PK 735
7700870961	6 PK 1685
7700871168	614ST
7700871169	625ST
7700872023	ZRK 1436
7700872531	627ST
7700872533	5 PK 880
7700872579	ZRK 1436
7700873731	627ST
7700874202	6 PK 1400
7700875305	195UT
7700875307	631UT
7700875412	ZRK 1522
7700875439	ZRK 1195
7700875585	ZRK 1146
77008857325	ZRK 1135
7701005702	AVX 10 x 1215
7701009603	AVX 10 x 1200
7701010887	AVX 10 x 1175
7701017999	AVX 10 x 1050
7701018003	AVX 10 x 913
7701018003	AVX 10 x 925
7701018005	AVX 13 x 1050
7701018005	AVX 13 x 1050 TM
7701023183	AVX 13 x 1300
7701023183	AVX 13 x 1300 TM
7701027182	AVX 10 x 1350
7701029700	AVX 10 x 1060
7701029702	AVX 10 x 1175
7701029703	AVX 10 x 1200
7701029704	AVX 10 x 1250



Teilenummer Part number	Abmessung Dimension	Teilenummer Part number	Abmessung Dimension	Teilenummer Part number	Abmessung Dimension
<b>RENAULT</b>		<b>RENAULT</b>		<b>RENAULT</b>	
7701029705	AVX 10 x 1250	7701468168	KT 1048	7711115394	169ST
7701029706	AVX 13 x 1300	7701469774	KT 1059	8200004342	6 PK 1775
7701029706	AVX 13 x 1300 TM	7701469776	KT 1117	8200004593	399UT
7701029707	AVX 10 x 1350	7701469821	KT 1086	8200007980	398ST
7701029708	AVX 10 x 1175	7701469822	KT 1065	8200009194	398ST
7701029709	AVX 10 x 1225	7701469823	KT 1066	8200009194B	398ST
7701029710	AVX 10 x 1400	7701469833	KT 1018	8200020924	5 PK 1130
7701029736	AVX 10 x 1050	7701471382	KT 1406	8200023912	6 PK 1145
7701035242	ZRK 1312	7701471426	KT 1141	8200027520	4 PK 735
7701035651	4 PK 560	7701471519	KT 1118	8200034396	5 PK 1200
7701035652	5 PK 820	7701471520	KT 1317	8200035827	169ST
7701035653	ZRK 1239	7701471769	KT 1091	8200036780	ZRK 1069
7701039690	5 PK 925	7701471770	KT 1229	8200039519	ZRK 1325
7701040204	359UT	7701471771	KT 1229	8200041848	3 PK 750
7701040944	4 PK 560	7701471772	KT 1098	8200041850	4 PK 925
7701043483	ZRK 1312	7701471773	KT 1217	8200041851	4 PK 905
7701044188	ZRK 1332	7701471774	KT 1340	8200041852	4 PK 1540
7701052770	6 PK 1920	7701471864	KT 1131	8200045127	167UT
7701055086	6 PK 1920	7701471866	KT 1129	8200045735	632ST
7701057890	7 PK 1920	7701471974	KT 1406	8200046148	ZRK 1475
7701057891	7 PK 1640	7701472185	KT 1434	8200051091	603UT
7701063978	ZRK 1436	7701472292	KT 1315	8200051092	611UT
7701063979	ZRK 1145	7701472329	KT 1392	8200058139	6 PK 1642
7701063980	ZRK 1075	7701472644	KT 1126	8200059395	6 PK 1138
7701063999	ZRK 1183	7701472675	KT 1126	8200059423	6 PK 850
7701064005	ZRK 1327	7701472696	KT 1408	8200059425	6 PK 870
7701064316	ZRK 1475	7701472725	KT 1128	8200061345	167UT
7701064326	ZRK 1069	7701472726	KT 1018	8200061673	5 PK 1110
7701064333	5 PK 886	7701473001	KT 1252	8200061697	167UT
7701064344	6 PK 1642	7701473053	KT 1315	8200064664	342ST
7701064349	5 PK 880	7701473120	KT 1368	8200065601	3 PK 740
7701065088	6 PK 1215	7701473312	KT 1434	8200071399	7 PK 1785
7701069667	7 PK 1640	7701473849	KT 1392	8200072113	7 PK 1125
7701268230	AVX 10 x 1275	7701474019	KT 1312	8200078576	6 PK 1605
7701348137	AVX 10 x 660	7701474021	KT 1409	8200079341	298ST
7701348228	AVX 10 x 725	7701474022	KT 1312	8200086697	167UT
7701348229	AVX 10 x 850	7701474022	KT 1315	8200088894	ZRK 1183
7701348230	AVX 10 x 775	7701474023	KT 1409	8200089047	6 PK 1190
7701348230	AVX 11,9 x 758	7701474359	KT 1410	8200093814	6 PK 1800
7701348323	AVX 10 x 650	7701474443	KT 1371	8200098343	ZRK 1183
7701348346	AVX 13 x 850	7701474514	6 PK 1105	8200102612	630UT
7701348507	AVX 10 x 1013	7701474517	4 PK 775	8200102941	343ST
7701348507	AVX 11,9 x 1010	7701474950	6 PK 1100	8200103069	169ST
7701348508	AVX 10 x 1075	7701475115	KT 1368	8200106085	ZRK 1427
7701348508	AVX 10 x 1075 TM	7701476571	KT 1368	8200111788	7 PK 1775
7701348549	AVX 10 x 700	7701476674	KT 1315	8200113203	6 PK 1795
7701348801	ZRK 1051	7701476675	KT 1312	8200127467	398ST
7701348934	AVX 10 x 1300	7701476675	KT 1476	8200127627	ZRK 1462
7701349028	AVX 10 x 825	7701476745	KT 1252	8200127693	7 PK 1785
7701349028	AVX 10 x 838	7701476884	KT 1129	8200142350	ZRK 1470
7701349038	AVX 10 x 825	7701476885	KT 1059	8200181178	ZRK 1075
7701349225	AVX 10 x 600	7701477012	KT 1368	8200188959	6 PK 1830
7701349226	AVX 10 x 635	7701477013	KT 1126	8200191324	440ST
7701349245	AVX 10 x 800	7701477014	KT 1406	8200200665	7 PK 1793
7701349425	AVX 10 x 900	7701477022	KT 1409	8200200666	7 PK 1145
7701349538	AVX 10 x 1140	7701477023	KT 1410	8200206889	5 PK 1125
7701349580	AVX 10 x 950	7701477024	KT 1128	8200208422	ZRK 1470
7701349590	AVX 10 x 950	7701477028	KT 1368	8200211651	4 PK 715
7701349594	AVX 11,9 x 1010	7701477048	KT 1434	8200211784	630UT
7701349620	AVX 11,9 x 1010	7701477050	KT 1371	8200211989	7 PK 1793
7701468163	KT 1046	7701477093	KT 1409	8200221695	ZRK 1475
7701468164	KT 1043	7701477184	KT 1312	8200222092	167UT
7701468165	KT 1065	7701477380	KT 1392	8200226493	6 PK 1660
7701468166	KT 1264	77018230	AVX 11,9 x 758	8200241629	ZRK 1325
7701468167	KT 1010	770749528	3PK 705	8200243021	6 PK 1205

Teilenummer Part number	Abmessung Dimension
----------------------------	------------------------

Teilenummer Part number	Abmessung Dimension
----------------------------	------------------------

Teilenummer Part number	Abmessung Dimension
----------------------------	------------------------

<b>RENAULT</b>	
----------------	--

8200244615	335ST
8200248497	ZRK 1428
8200251983	ZRK 1428
8200322233	7 PK 1035
8200322234	7 PK 880
8200344791	ZRK 1325
8200347761	440ST
8200356268	6 PK 1820
8200356446	7 PK 1970
8200366318	ZRK 1325
8200420960	631UT
8200420964	631UT
8200454895	169ST
8200461911	ZRK 1462
8200465689	7 PK 1105
8200466868	6 PK 1840
8200469376	611UT
8200483288	242UT
8200493939	7 PK 880
8200499908	167UT
8200499909	167UT
8200508612	ZRK 1325
8200537021	ZRK 1317
8200537023	ZRK 1470
8200537026	ZRK 1470
8200537033	ZRK 1325
8200542739	ZRK 1475
8200542740	ZRK 1067
8200542741	ZRK 1075
8200542743	ZRK 1428
8200542746	ZRK 1069
8200545581	ZRK 1103
8200585574	343ST
8200644900	7 PK 1110
8200676403	167UT
8200676404	167UT
8200704394	169ST
8200709717	346ST
8200786314	5 PK 1125
8200795488	7 PK 1110
8200821800	6 PK 1820
8200821813	6 PK 1205
8200821816	6 PK 1130
8200830182	3 PK 740
8200830184	7 PK 880
8200830187	4 PK 905
8200830190	4 PK 925
8200830192	4 PK 1540
8200830196	7 PK 1035
8200833541	5 PK 1750
8200833543	6 PK 1605
8200833549	6 PK 1795
8200833550	7 PK 1125
8200833554	7 PK 1785
8200833555	7 PK 1793
8200833558	7 PK 1793
8200833566	6 PK 1145
8200833568	6 PK 1775
8200833570	6 PK 1795
8200833574	7 PK 1105
8200839580	398ST
8200841132	5 PK 1110
8200846156	6 PK 1190
8200850092	5 PK 1200
8200897097	ZRK 1470

<b>RENAULT</b>	
----------------	--

8200897100	ZRK 1470
8200989169	167UT
8200989172	167UT
8973331030	6 PK 1920
921232003	AVX 13 x 800
921232003	AVX 13 x 800 TM
921232007	AVX 13 x 1525
921232007	AVX 13 x 1525 TM
9618337580	ZRK 1703
96251516	6 PK 1605
96294079	6 PK 1600
9629407980	6 PK 1600
9630034080	6 PK 1600
96300342	6 PK 1600
9632391980	6 PK 1600
9632600080	6 PK 1600
9638027080	6 PK 1580
9638027180	6 PK 1580
9649592880	6 PK 1590
9652391980	6 PK 1600
98412210	4 PK 560
98423681	5 PK 850
98452287	5 PK 820
98456477	ZRK 1332

<b>RENAULT TRUCKS</b>	
-----------------------	--

5010477838	9 PK 1690 TM
5010550335	KT 7001

<b>ROLLS-ROYCE</b>	
--------------------	--

11287544787	6 PK 1605
UE34568	AVX 10 x 875
UE34569	AVX 10 x 925

<b>ROVER</b>	
--------------	--

13H924	AVX 10 x 935
13H924	AVX 10 x 938
219560	AVX 10 x 813
247920	AVX 10 x 913
247939	AVX 10 x 950
247941	AVX 13 x 1575
276451	AVX 13 x 1475
276741	AVX 13 x 1375
278546	AVX 10 x 850
278547	AVX 10 x 875
279023126306	4 PK 725
279123116302	5 PK 1070
31110P44G03	5 PK 954
31110PB0004	5 PK 954
31110PH7013	3 PK 1080
31110PH7013	3 PK 1080
33402327	AVX 10 x 813
38920P1K505	4 PK 795
38920P2A003	4 PK 825
38920PTO003	5 PK 1104
513907	AVX 10 x 888
524200	AVX 10 x 1050
563132	AVX 10 x 1025
56992P44G03	4 PK 1075
56992PTOJ01	4 PK 1075
596433	AVX 10 x 900
602319	AVX 10 x 1150
611612	AVX 13 x 1000
613602	AVX 10 x 1225
614106	AVX 13 x 925

<b>ROVER</b>	
--------------	--

9194009101	4 PK 913
ADU6528	AVX 10 x 938
ADU8335	259UT
ADU9401	AVX 10 x 1050
AHU2716	3 PK 750
AHU2749	6 PK 1445
BMK1020	AVX 13 x 1350
BMK1046	AVX 13 x 1125
BMK1067	AVX 13 x 1125
BMK1113	AVX 13 x 1075
BMK1963	AVX 10 x 800
BMK686	AVX 10 x 1075
BMK686	AVX 10 x 1075 TM
BMK977	AVX 13 x 1300
CAM7910	AVX 10 x 950
CAM9135	878ST
CAM9153	878ST
CDU2160	3 PK 750
CDU2749	ZRK 1151
CDU3558	258ST
CDU3559	177ST
DBP4066	3 PK 763
DBP4067	3 PK 763
DBP4131	ZRK 1109
DBP4281	3 PK 750
DBP9213	3 PK 740
DBP9214	3 PK 740
DBP9289	ZRK 1109
DBP9290	877ST
DBP9291	877ST
ECP244	ZRK 1199
ERC0026	AVX 13 x 1175
ERC0400	AVX 13 x 850
ERC1347	AVX 13 x 850
ERC2774	AVX 13 x 850
ERC304	AVX 10 x 913
ERC5146	AVX 13 x 750
ERC5836	AVX 10 x 1125
ERC675	AVX 13 x 925
ERC68886	AVX 10 x 1025
ERC7333	ZRK 1214
ERC7763	ZRK 1214
ERC8861	388ST
ERC8938	AVX 10 x 1050
ERR1092	ZRK 1307
ERS0815	ZRK 1307
ETC4272	AVX 13 x 800
ETC7333	ZRK 1214
ETC9080	AVX 13 x 875
FDU1053	875ST
FDU1055	875ST
FDU1464	ZRK 1178
FDU1466	ZRK 1166
FDU1817EVA	3 PK 763
FDU2691	875ST
GCB10937	AVX 10 x 935
GCB10937	AVX 10 x 938
GFB101	AVX 10 x 925
GFB101415	6 PK 1413
GFB101448	6 PK 1445
GFB102	AVX 10 x 813
GFB103	AVX 10 x 900
GFB104	AVX 10 x 825
GFB105	AVX 10 x 1110
GFB1120	5 PK 2030

Teilenummer Part number	Abmessung Dimension	Teilenummer Part number	Abmessung Dimension	Teilenummer Part number	Abmessung Dimension
<b>ROVER</b>		<b>ROVER</b>		<b>ROVER</b>	
GFB1121	5 PK 870	GFB358	4 PK 913	GMB61185	6 PK 1185
GFB1122	6 PK 1560	GFB359	3 PK 1080	GMB61290	6 PK 1285
GFB1123	6 PK 1285	GFB360	3 PK 763	GMB61415	6 PK 1413
GFB120	AVX 10 x 864	GFB366	3 PK 740	GMB61448	6 PK 1445
GFB121	AVX 10 x 850	GFB367	3 PK 763	GMB61465	6 PK 1460
GFB122	AVX 10 x 1125	GFB371	3 PK 1080	GMB61553	6 PK 1555
GFB123	AVX 13 x 1100	GFB372	3 PK 763	GMB70755	3 PK 750
GFB124	AVX 10 x 1025	GFB373	3 PK 763	GRP101448	6 PK 1445
GFB127	AVX 10 x 888	GFB375	4 PK 870	GTB1127A	ZRK 1114
GFB128	AVX 13 x 1075	GFB378	3 PK 1080	GTB1238XS	ZRK 1151
GFB136	AVX 10 x 975	GFB400	4 PK 813	GTB1289	ZRK 1020
GFB142	AVX 10 x 1100	GFB402	5 PK 954	GTB1290	ZRK 1181
GFB144	AVX 10 x 1275	GFB403	5 PK 954	GTB1291	ZRK 1171
GFB145	AVX 10 x 975	GFB404	5 PK 1104	GTB1292	ZRK 1152
GFB147	AVX 13 x 1175	GFB405	4 PK 1075	GTB1497XS	ZRK 1749
GFB165	AVX 10 x 1050	GFB406	5 PK 1104	GTB2003	ZRK 1077
GFB168	AVX 10 x 1025	GFB407	5 PK 1104	GTB2004	ZRK 1076
GFB170	AVX 10 x 1125	GFB408	3 PK 785	GTB2005XS	ZRK 1171
GFB176	AVX 10 x 888	GFB50949	AVX 10 x 950	GTB2017XS	ZRK 1299
GFB183	AVX 10 x 825	GFB60838	AVX 10 x 838	GTB9000	ZRK 1350
GFB183	AVX 10 x 838	GFB60937	AVX 10 x 935	GTB9003XS	ZRK 1299
GFB185	AVX 10 x 813	GFB60937	AVX 10 x 938	GTB9005	ZRK 1334
GFB189	AVX 13 x 1075	GFB61038	AVX 10 x 1050	JPB100045EV	4 PK 813
GFB192	AVX 10 x 838	GFB701	AVX 10 x 935	LHN10013	ZRK 1262
GFB195	AVX 10 x 825	GFB701	AVX 10 x 938	LHN10015	ZRK 1262
GFB196	AVX 10 x 888	GFB702	5 PK 698	LHN10016	ZRK 1020
GFB197	AVX 10 x 838	GFB70755	3 PK 750	LHN100390	ZRK 1299
GFB202	AVX 10 x 1225	GFB80743	4 PK 735	LHN100410	ZRK 1350
GFB205	AVX 10 x 950	GFB80750	4 PK 750	LHN100560	ZRK 1749
GFB206	AVX 10 x 950	GFB80755	4 PK 755	LHN100760	ZRK 1334
GFB20864	AVX 13 x 850	GFB80760	4 PK 763	LHN100830	ZRK 1299
GFB209	AVX 10 x 1100	GFB80770	4 PK 775	LHP100070	277UT
GFB210	AVX 10 x 838	GFB80795	4 PK 795	LHP10009	262UT
GFB21075	AVX 13 x 1075	GFB80910	4 PK 913	LHP10010	284ST
GFB211	AVX 10 x 1225	GFB80925	4 PK 920	LHP10011	193ST
GFB212	AVX 10 x 950	GFB90633	5 PK 640	LHP10013	254ST
GFB213	AVX 10 x 1100	GFB90698	5 PK 698	LHP10014	177ST
GFB214	AVX 10 x 913	GFB91150	5 PK 1145	LHP10015	258ST
GFB215	AVX 13 x 1175	GFB91165	5 PK 1165	LHP10016	193ST
GFB216	AVX 13 x 850	GFB91170	5 PK 1175	LHP100390	336ST
GFB223	AVX 10 x 888	GFB91496	5 PK 1500	LHP100440	876ST
GFB227	AVX 13 x 1175	GFB91790	5 PK 1790	LHP100450	876ST
GFB233	AVX 13 x 850	GMB101	4 PK 790	LHP100550	338ST
GFB240	AVX 10 x 838	GMB102	4 PK 795	LHP100590	274ST
GFB243	AVX 13 x 1075	GMB103	4 PK 813	LHP100790	224ST
GFB246	AVX 10 x 1050	GMB104	5 PK 954	LHP100840	340ST
GFB248	AVX 10 x 1100	GMB107	4 PK 1075	LHV100080	255UT
GFB249	AVX 10 x 950	GMB108	4 PK 870	LHV100120	337UT
GFB250	AVX 10 x 950	GMB109	4 PK 825	LHV100160	341UT
GFB251	AVX 10 x 813	GMB30735	3 PK 750	LHV100160A	341UT
GFB252	AVX 10 x 825	GMB30738	3 PK 740	MVF10001	ZRK 1076
GFB253	AVX 10 x 838	GMB30755	3 PK 750	PQS000367EV	3 PK 763
GFB255	AVX 10 x 950	GMB40750	4 PK 750	PQS000403EV	5 PK 954
GFB258	AVX 10 x 1050	GMB40770	4 PK 775	PQS051495EV	5 PK 1500
GFB259	AVX 13 x 925	GMB40910	4 PK 913	PQS10009EV	AVX 10 x 938
GFB260	AVX 10 x 710	GMB50735	5 PK 735	PQS10013	4 PK 750
GFB262	AVX 10 x 975	GMB50830	5 PK 830	PQS10013EV	4 PK 750
GFB264	AVX 13 x 1075	GMB50956	5 PK 954	PQS10028	4 PK 775
GFB272	AVX 10 x 935	GMB51145	5 PK 1145	PQS10028EV	4 PK 775
GFB272	AVX 10 x 938	GMB51150	5 PK 1145	PQS10035	6 PK 1445
GFB273	AVX 10 x 875	GMB51165	5 PK 1165	PQS10043EV	5 PK 698
GFB303	AVX 13 x 1000	GMB51165XS	5 PK 1165	PQS10044	5 PK 1165
GFB350	3 PK 740	GMB51496	5 PK 1500	PQS10045EV	6 PK 1413
GFB352	3 PK 750	GMB51790	5 PK 1790	PQS10056EV	3 PK 1080
GFB356	3 PK 1080	GMB61180	6 PK 1185	PQS10065EV	3 PK 785





Teilenummer Part number	Abmessung Dimension
----------------------------	------------------------

Teilenummer Part number	Abmessung Dimension
----------------------------	------------------------

Teilenummer Part number	Abmessung Dimension
----------------------------	------------------------

**ROVER**

PQS100760EV	5 PK 1104
PQS100840	5 PK 735
PQS100850	6 PK 1460
PQS100940	5 PK 1145
PQS100950EV	5 PK 1790
PQS101010	4 PK 813
PQS101030	6 PK 1185
PQS101080	4 PK 790
PQS101140	5 PK 830
PQS101160EV	5 PK 954
PQS101180	5 PK 1200
PQS101210	6 PK 1555
PQS101261	6 PK 1285
PQS101262	6 PK 1285
PQS101271	6 PK 1560
PQS101272	6 PK 1560
PQS101290EV	4 PK 1075
PQS101300	5 PK 2030
PQS101310	5 PK 870
PQS101340	4 PK 870
PQS101380	4 PK 795
PQS101450	3 PK 740
PQS101460	4 PK 825
PQS101590	5 PK 1165
PWS100730E	5 PK 1104
RTC9019	AVX 13 x 1175
TKC2802	AVX 10 x 935
TKC2802	AVX 10 x 938
UAM1599	ZRK 1016
WAM2804	ZRK 1150
XHM460	ZRK 1199
XHM5788EVA	4 PK 913

**SAAB**

24435940	5 PK 1030
24452030	6 PK 1900
379117	AVX 13 x 1950
4029195	6 PK 2330
4029203	6 PK 2550
4029930	750UR
4165080	6 PK 1900
4237038	508UR
4356887	5 PK 1590
4356895	6 PK 2330
4356903	6 PK 2550
4359063	6 PK 2625
4359071	6 PK 2013
4360111	6 PK 2305
4360467	6 PK 2305
4395406	6 PK 2013
4395422	6 PK 2305
4395430	6 PK 1890
4395448	6 PK 2330
4395455	6 PK 2550
4395463	6 PK 2228
4448400	AVX 10 x 850
4504080	525UT
4552648	6 PK 2020
4575486	6 PK 1800
4575528	6 PK 1900
4621348	ZRK 1022
4752861	6 PK 2020
4770459	525UT
4770475	525UT
4770483	525UT

**SAAB**

4770491	ZRK 1022
4770558	525UT
4773842	524UT
4896312	6 PK 2000
4899555	6 PK 2020
4904116	6 PK 2550
4904728	6 PK 2625
4961058	6 PK 1800
4961066	6 PK 2345
4965687	6 PK 1980
5340526	6 PK 1800
5340534	6 PK 1900
5342464	6 PK 1920
53430443	6 PK 1920
5343280	6 PK 1900
55201363	6 PK 1725
55556404	5 PK 1030
55564662	6 PK 1725
5590344	6 PK 2415
71854429	508UR
731053	AVX 10 x 1025
7511728	AVX 10 x 975
7551674	5 PK 1610
7579881	5 PK 1610
7596679	5 PK 1590
8000397	AVX 10 x 1000
814186	AVX 13 x 1000
814187	AVX 13 x 1025
814188	AVX 13 x 1050
814189	AVX 13 x 1075
814190	AVX 13 x 1100
814191	AVX 13 x 1125
814192	AVX 13 x 1150
814193	AVX 13 x 1175
814194	AVX 13 x 1200
814195	AVX 13 x 1225
814196	AVX 13 x 1250
814197	AVX 13 x 1275
814199	AVX 13 x 1325
814200	AVX 13 x 1350
814201	AVX 13 x 1375
814202	AVX 13 x 1400
814203	AVX 13 x 1425
814204	AVX 13 x 1450
814205	AVX 13 x 1475
814206	AVX 13 x 1500
814207	AVX 13 x 1525
814208	AVX 13 x 1550
814209	AVX 13 x 1575
814210	AVX 13 x 1600
814211	AVX 13 x 1625
814212	AVX 13 x 1650
814213	AVX 13 x 1675
814214	AVX 13 x 1700
814215	AVX 13 x 1725
814216	AVX 13 x 1750
814217	AVX 13 x 1775
814218	AVX 13 x 1800
814219	AVX 13 x 1825
814222	AVX 13 x 1900
814774	AVX 13 x 950
830050	AVX 10 x 838
8322026	AVX 10 x 813
8339921	AVX 10 x 825
8339939	AVX 10 x 875

**SAAB**

833994	AVX 10 x 990
837573	AVX 10 x 763
8375735	AVX 10 x 775
837911	AVX 10 x 775
838492	AVX 10 x 975
883391	AVX 10 x 1100
90502734	6 PK 1900
9128739	506UT
9240033	418UT
93172363	5 PK 1240
93178807	421UT
93178811	ZRK 1540
93178812	ZRK 1466
93178816	371ST
9318056	5 PK 1610
93181196	6 PK 1413
93181966	371ST
93184450	6 PK 1413
93185049	6 PK 2625
93185050	6 PK 2345
93185051	6 PK 2550
93185058	6 PK 2305
93185336	ZRK 1540
93185379	6 PK 1395
93185756	6 PK 2120
93190810	6 PK 1395
93192015	6 PK 1413
9323510	AVX 10 x 975
9339409	AVX 10 x 1250
9341314	AVX 10 x 975
9347048	AVX 10 x 1250
9361791	AVX 10 x 1175
9367020	AVX 13 x 1175
9369133	AVX 10 x 975
9382383	AVX 13 x 1275

**SAN**

1752151A00	4 PK 813
1752161A00	4 PK 805
3545086CA0	6 PK 1470
4918160A00	4 PK 790
9514160A50	4 PK 805
9514160A60	4 PK 920

**SANTANA**

181675	AVX 10 x 1100
181677	AVX 13 x 925
711644	AVX 10 x 800

**SAURER**

1541330003	AVX 13 x 975
1541330003	AVX 13 x 975 TM
1541330004	AVX 13 x 1300
1541330004	AVX 13 x 1300 TM
4651330030	AVX 13 x 1250
4651330030	AVX 13 x 1250 TM

**SAVIEM**

0023245089	AVX 10 x 990
0023255089	AVX 10 x 990
0023255090	AVX 10 x 950
0023255097	AVX 10 x 925
0023255166	AVX 13 x 1200
0023255166	AVX 13 x 1200 TM
0023255179	AVX 13 x 1125



Teilenummer Part number	Abmessung Dimension
----------------------------	------------------------

Teilenummer Part number	Abmessung Dimension
----------------------------	------------------------

Teilenummer Part number	Abmessung Dimension
----------------------------	------------------------

**SAVIEM**

0023255179	AVX 13 x 1125 TM
0023255182	AVX 13 x 1050
0023255182	AVX 13 x 1050 TM
0023255183	AVX 13 x 1375
0023255183	AVX 13 x 1375 TM
0023255184	AVX 13 x 1400 TM
0023255185	AVX 13 x 1450
0023255185	AVX 13 x 1450 TM
0023255189	AVX 13 x 1650
0023255189	AVX 13 x 1650 TM
0023255191	AVX 13 x 1700
0023255191	AVX 13 x 1700 TM
0023255194	AVX 13 x 1050
0023255194	AVX 13 x 1050 TM
0023255195	AVX 13 x 1225
0023255195	AVX 13 x 1225 TM
0023255196	AVX 13 x 1100 TM
0023255199	AVX 13 x 1100 TM
0023255604	AVX 13 x 900
0023255604	AVX 13 x 900 TM
0023255605	AVX 10 x 1225
0023255644	AVX 13 x 1450
0023255644	AVX 13 x 1450 TM
0023255648	AVX 13 x 1550
0023255648	AVX 13 x 1550 TM
0023255702	AVX 13 x 1250
0023255702	AVX 13 x 1250 TM
0023255703	AVX 13 x 1325
0023255703	AVX 13 x 1325 TM
0023255704	AVX 13 x 1325
0023255704	AVX 13 x 1325 TM
0023255705	AVX 13 x 1375
0023255705	AVX 13 x 1375 TM
0038445011	AVX 10 x 1150
0038445015	AVX 13 x 1700
0038445015	AVX 13 x 1700 TM
0038445016	AVX 13 x 1375
0038445016	AVX 13 x 1375 TM
0854343200	AVX 13 x 1050
0854343200	AVX 13 x 1050 TM
0854649000	AVX 10 x 625
0854649100	AVX 10 x 650
0854679600	AVX 10 x 1050
0854687200	AVX 10 x 975
0855242700	AVX 10 x 1050
0855261000	AVX 13 x 925
0855261000	AVX 13 x 925 TM
0855471100	AVX 13 x 1175
0855471100	AVX 13 x 1175 TM
0855505800	AVX 10 x 850
0855633900	AVX 10 x 625
0855676000	AVX 10 x 725
0855676100	AVX 10 x 850
0855679400	AVX 13 x 875
0855679400	AVX 13 x 875 TM
0855721100	AVX 10 x 750
0855839800	AVX 10 x 700
0855931900	AVX 10 x 660
0857509200	AVX 13 x 1225
0857509200	AVX 13 x 1225 TM
50000182322	AVX 13 x 1650
50000182322	AVX 13 x 1650 TM
50000182325	AVX 13 x 1225
50000182325	AVX 13 x 1225 TM
5000020188	AVX 13 x 1400 TM

**SAVIEM**

5000020189	AVX 13 x 1400 TM
5000020190	AVX 13 x 1475
5000020190	AVX 13 x 1475 TM
5000021655	AVX 13 x 1325
5000021655	AVX 13 x 1325 TM
5000022632	AVX 13 x 1300
5000022632	AVX 13 x 1300 TM
50000255670	AVX 13 x 1475
50000255670	AVX 13 x 1475 TM
50000281868	AVX 13 x 1475
50000281868	AVX 13 x 1475 TM
5000030114	AVX 13 x 1800
5000030114	AVX 13 x 1800 TM
5000030307	AVX 13 x 1425
5000030307	AVX 13 x 1425 TM
5000030848	AVX 13 x 1750
5000030848	AVX 13 x 1750 TM
5000031149	AVX 13 x 1050
5000031149	AVX 13 x 1050 TM
5000031150	AVX 13 x 1425
5000031150	AVX 13 x 1425 TM
5000031369	AVX 13 x 1050
5000031369	AVX 13 x 1050 TM
5000031483	AVX 13 x 1050
5000031483	AVX 13 x 1050 TM
5000033012	AVX 13 x 1000
5000033012	AVX 13 x 1000 TM
5000033043	AVX 13 x 850
5000033045	AVX 13 x 750
5000033045	AVX 13 x 750 TM
5000034802	AVX 10 x 990
5000035610	AVX 13 x 1200
5000035610	AVX 13 x 1200 TM
5000037892	AVX 13 x 1950
5000037892	AVX 13 x 1950 TM
5000041119	AVX 13 x 900
5000041119	AVX 13 x 900 TM
5000041121	AVX 13 x 900
5000041121	AVX 13 x 900 TM
5000041122	AVX 10 x 1225
5000041514	AVX 13 x 1225
5000041514	AVX 13 x 1225 TM
5000042052	AVX 13 x 1325
5000042052	AVX 13 x 1325 TM
5000042347	AVX 13 x 1400 TM
5000042452	AVX 13 x 1125
5000042452	AVX 13 x 1125 TM
5000042711	AVX 13 x 1250
5000042711	AVX 13 x 1250 TM
5000043146	AVX 13 x 1125
5000043146	AVX 13 x 1125 TM
5000043147	AVX 13 x 1175
5000043147	AVX 13 x 1175 TM
5000043148	AVX 10 x 990
5000043149	AVX 13 x 900
5000043149	AVX 13 x 900 TM
5000043202	AVX 13 x 1225
5000043202	AVX 13 x 1225 TM
5000043347	AVX 13 x 1475
5000043347	AVX 13 x 1475 TM
5000043631	AVX 10 x 990
5000043649	AVX 13 x 900
5000043649	AVX 13 x 900 TM
5000043705	AVX 13 x 1125
5000043705	AVX 13 x 1125 TM

**SAVIEM**

5000043771	AVX 13 x 1400 TM
5000044031	AVX 10 x 1225
5000044406	AVX 13 x 1125
5000044406	AVX 13 x 1125 TM
5000044717	AVX 10 x 990
5000044858	AVX 13 x 900
5000044858	AVX 13 x 900 TM
5000046526	AVX 13 x 1250
5000046526	AVX 13 x 1250 TM
5000046541	AVX 13 x 1500
5000046541	AVX 13 x 1500 TM
5000047059	AVX 10 x 1075
5000047059	AVX 10 x 1075 TM
5000047950	AVX 10 x 1075
5000047950	AVX 10 x 1075 TM
5000047952	AVX 10 x 1200
5000048223	AVX 10 x 1200
5000048793	AVX 10 x 1225
5000048794	AVX 10 x 1225
5000048795	AVX 13 x 900
5000048795	AVX 13 x 900 TM
5000048858	AVX 13 x 900
5000048858	AVX 13 x 900 TM
5000048930	AVX 10 x 990
5000048933	AVX 13 x 1125
5000048933	AVX 13 x 1125 TM
5000048934	AVX 13 x 1175
5000048934	AVX 13 x 1175 TM
5000049293	AVX 13 x 1125
5000049293	AVX 13 x 1125 TM
5000049298	AVX 13 x 900
5000049298	AVX 13 x 900 TM
5000049301	AVX 10 x 1225
5000049616	AVX 13 x 1400 TM
5000049619	AVX 13 x 1200
5000049619	AVX 13 x 1200 TM
5000049858	AVX 13 x 900
5000049858	AVX 13 x 900 TM
5000157516	AVX 13 x 1025
5000157516	AVX 13 x 1025 TM
5000168026	AVX 13 x 1375
5000168026	AVX 13 x 1375 TM
5000168112	AVX 13 x 850
5000168115	AVX 13 x 1000
5000168115	AVX 13 x 1000 TM
5000168118	AVX 13 x 750
5000168118	AVX 13 x 750 TM
5000168462	AVX 13 x 1050
5000168462	AVX 13 x 1050 TM
5000182323	AVX 13 x 1550
5000182323	AVX 13 x 1550 TM
5000182324	AVX 13 x 1950
5000182324	AVX 13 x 1950 TM
5000182326	AVX 13 x 1100 TM
5000250769	AVX 13 x 1450
5000250769	AVX 13 x 1450 TM
5000280844	AVX 13 x 1450
5000280844	AVX 13 x 1450 TM
5000434559	AVX 13 x 1650
5000434559	AVX 13 x 1650 TM

**SCANIA**

0454282	8 PK 1255 TM
131350	AVX 13 x 1600 TM
1354390	8 PK 1515 TM



Teilenummer Part number	Abmessung Dimension
----------------------------	------------------------

Teilenummer Part number	Abmessung Dimension
----------------------------	------------------------

Teilenummer Part number	Abmessung Dimension
----------------------------	------------------------

**SCANIA**

1354390	KT 7007
1371531	8 PK 2045 TM
1371532	8 PK 2045 TM
1371533	8 PK 2164 TM
1371788	KT 7007
1372544	AVX 13 x 1600
1372544	AVX 13 x 1600 TM
1372545	AVX 13 x 1900
1372545	AVX 13 x 1900 TM
1374317	AVX 13 x 1750
1374317	AVX 13 x 1750 TM
1376316	8 PK 1515 TM
1389011	8 PK 1985 TM
1389012	8 PK 1540 TM
1389023	8 PK 1515 TM
1389024	8 PK 2130 TM
1389028	8 PK 1985 TM
1389029	8 PK 1540 TM
1389031	8 PK 2215 TM
1389034	8 PK 2215 TM
1389041	8 PK 2045 TM
1389042	8 PK 2164 TM
1389048	8 PK 2130 TM
1389049	8 PK 1515 TM
1389052	8 PK 2000 TM
1389058	8 PK 2080 TM
1389059	8 PK 1795 TM
1389060	8 PK 1255 TM
1389066	8 PK 1220 TM
139954	AVX 13 x 1500
139954	AVX 13 x 1500 TM
1420908	AVX 13 x 1900
1420908	AVX 13 x 1900 TM
1420909	AVX 13 x 1600
1420909	AVX 13 x 1600 TM
1420911	AVX 13 x 1600
1420911	AVX 13 x 1600 TM
1422283	AVX 13 x 1600
1422283	AVX 13 x 1600 TM
1454280	8 PK 1985 TM
1454281	8 PK 1540 TM
1454282	8 PK 1255 TM
1459988	KT 7007
149046	AVX 13 x 1625
149046	AVX 13 x 1625 TM
1490819	8 PK 2130 TM
1490821	8 PK 2130 TM
1493670	KT 7007
1503113	KT 7007
1512179	8 PK 2000 TM
1514865	8 PK 1795 TM
1519788	8 PK 1515 TM
1530960	8 PK 2164 TM
1530973	8 PK 1515 TM
1530974	8 PK 2045 TM
1530979	8 PK 2215 TM
1530984	8 PK 2080 TM
1531241	8 PK 1220 TM
153532	AVX 13 x 1500
153532	AVX 13 x 1500 TM
1545982	KT 7007
167644	AVX 13 x 1450
167644	AVX 13 x 1450 TM
167844	AVX 13 x 1450
167844	AVX 13 x 1450 TM

**SCANIA**

170391	AVX 13 x 1550
170391	AVX 13 x 1550 TM
170856	AVX 13 x 1250 TM
173494	AVX 13 x 1600 TM
173495	AVX 13 x 1625
173495	AVX 13 x 1625 TM
175858	AVX 13 x 1575
175858	AVX 13 x 1575 TM
179648	AVX 13 x 1525
179648	AVX 13 x 1525 TM
1800521	8 PK 1985 TM
188205	AVX 13 x 1450
188205	AVX 13 x 1450 TM
1888463	8 PK 1985 TM
1888464	8 PK 1540 TM
1888522	8 PK 1540 TM
205637	AVX 13 x 1300
205637	AVX 13 x 1300 TM
208981	AVX 13 x 1225
208981	AVX 13 x 1225 TM
287513	AVP 13 x 1825 TM
293009	AVX 13 x 1475
293009	AVX 13 x 1475 TM
293064	AVX 13 x 1200
293064	AVX 13 x 1200 TM
306596	AVX 13 x 1425
306596	AVX 13 x 1425 TM
402038	AVX 13 x 1425
402038	AVX 13 x 1425 TM
411299	AVX 13 x 1900
411299	AVX 13 x 1900 TM
422849	AVX 13 x 1800
422849	AVX 13 x 1800 TM
652150	AVX 13 x 1675
652150	AVX 13 x 1675 TM
804193	AVX 13 x 1175
804193	AVX 13 x 1175 TM
814186	AVX 13 x 1000
814186	AVX 13 x 1000 TM
814187	AVX 13 x 1025
814187	AVX 13 x 1025 TM
814188	AVX 13 x 1050
814188	AVX 13 x 1050 TM
814189	AVX 13 x 1075 TM
814190	AVX 13 x 1100 TM
814191	AVX 13 x 1125
814191	AVX 13 x 1125 TM
814192	AVX 13 x 1150
814192	AVX 13 x 1150 TM
814193	AVX 13 x 1175 TM
814194	AVX 13 x 1200
814194	AVX 13 x 1200 TM
814195	AVX 13 x 1225
814195	AVX 13 x 1225 TM
814196	AVX 13 x 1250
814196	AVX 13 x 1250 TM
814197	AVX 13 x 1275
814197	AVX 13 x 1275 TM
814198	AVX 13 x 1300
814198	AVX 13 x 1300 TM
814199	AVX 13 x 1325
814199	AVX 13 x 1325 TM
814200	AVX 13 x 1350 TM
814201	AVX 13 x 1375
814201	AVX 13 x 1375 TM

**SCANIA**

814202	AVX 13 x 1400 TM
814203	AVX 13 x 1425
814203	AVX 13 x 1425 TM
814204	AVX 13 x 1450
814204	AVX 13 x 1450 TM
814205	AVX 13 x 1475 TM
814206	AVX 13 x 1500
814206	AVX 13 x 1500 TM
814207	AVX 13 x 1525
814209	AVX 13 x 1575
814209	AVX 13 x 1575 TM
814210	AVX 13 x 1600 TM
814211	AVX 13 x 1600 TM
814211	AVX 13 x 1625
814211	AVX 13 x 1625 TM
814216	AVX 13 x 1750
814216	AVX 13 x 1750 TM
814218	AVX 13 x 1800 TM
814219	AVX 13 x 1825
814219	AVX 13 x 1825 TM
814220	AVX 13 x 1825
814220	AVX 13 x 1825 TM
814222	AVX 13 x 1900 TM
814774	AVX 13 x 950
814774	AVX 13 x 950 TM
814834	AVX 13 x 1300
814834	AVX 13 x 1300 TM
815359	AVX 13 x 1300
815359	AVX 13 x 1300 TM
8384927	AVX 10 x 975

**SEAT**

01201204	ZRK 1030
022145933G	6 DPK 1320
026109243	100UT
026109243	175UT
026109243A	100UT
026109243A	175UT
026109243C	100UT
026109243C	175UT
026109243E	100UT
026109243E	175UT
026109243F	100UT
026109243L	100UT
026109243L	175UT
026145271	AVX 10 x 730
026903137C	AVX 10 x 950
027109243	102ST
027198119	KT 1382
027903137	AVX 10 x 630
027903137A	AVX 10 x 864
028109119AC	ZRK 1339
028109119N	ZRK 1339
028109243B	129ST
028109243D	121ST
028109243E	128ST
028109243F	128ST
028109243G	121ST
028109244	111UT
028145271H	AVX 11,5 x 790
028145271M	AVX 11,5 x 790
028145278A	114SR
028145278E	114SR
028198119	KT 1004
028198119A	KT 1021



Teilenummer Part number	Abmessung Dimension	Teilenummer Part number	Abmessung Dimension	Teilenummer Part number	Abmessung Dimension
<b>SEAT</b>		<b>SEAT</b>		<b>SEAT</b>	
028198119B	KT 1014	037903137E	6 PK 894	03L198119	KT 1420
028198119C	KT 1358	037903137F	6 PK 975	03L903137	6 PK 1070
028198119E	KT 1087	037903137G	6 PK 975	03L903137A	6 PK 1580
028198119G	KT 1326	037903137H	6 PK 1035	03L903137B	6 EPK 842
028260849D	6 PK 1145	038109119N	ZRK 1338	03L998037	6 EPK 842
028260849J	6 PK 1145	038109119P	ZRK 1338	045109243A	152ST
028260849L	6 PK 1145	038109119S	ZRK 1338	045109243B	159ST
028903137AD	6 PK 925	038109243	155ST	045109243C	152ST
028903137AM	6 PK 925	038109243D	155ST	045109243D	159ST
028903137AP	5 PK 1219	038109243F	155ST	045109243F	162ST
028903137AS	6 PK 1055	038109243G	155ST	045109244A	160UT
028903137BB	6 PK 1045	038109243H	155ST	045109479B	161ST
028903137T	6 PK 1045	038109243M	162ST	045109479C	151ST
030109243D	125ST	038109243N	155ST	045260849	6 DPK 1188
030109243F	125ST	038109244B	132UT	045903137D	6 PK 995
030109243J	125ST	038109244C	132UT	045903137E	6 PK 858
030109243K	125ST	038109244E	150UT	047903137E	6 PK 1880
030109243L	222ST	038109244H	132UT	047903137G	6 PK 1520
030145933	6 PK 1100	038109244J	163UT	048109119G	ZRK 1222
030145933E	6 PK 1070	038109244M	132UT	048198119	KT 1381
030145933L	6 PK 1070	038109244Q	150UT	051109243	102ST
030145933M	6 PK 1070	038145276	140UR	051109243A	393ST
030145933R	6 PK 1070	038145933J	6 PK 1078	051198119	KT 1288
030145933T	6 PK 1070	038198119	KT 1238	05290313F	AVX 10 x 675
030198119A	KT 1034	038198119A	KT 1237	056109119A	ZRK 1056
030198119B	KT 1285	038198119B	KT 1248	058109244	119UT
030903137K	6 PK 737	038198119C	KT 1237	066145933J	6 DPK 1320
030903137T	6 PK 750	038198119F	KT 1226	066145933K	6 PK 1265
031130113D	ZRK 1265	038903137AA	6 PK 1185	068109243	101ST
032145933	6 PK 1185	038903137E	6 PK 1660	068109243C	101ST
032145933C	6 PK 1125	038903137G	6 PK 906	068109243F	101ST
032145933E	6 PK 1125	038903137J	6 PK 1660	068260849G	AVX 13 x 950
032145933G	6 PK 1125	038903137L	6 PK 1185	068903137D	AVX 10 x 965
032145933S	6 PK 1125	038903137M	6 PK 780	068903137D	AVX 11,9 x 950
032145933T	6 PK 1185	038903137S	6 DPK 1215	068903137D	AVX 11,9 x 965
032198119	KT 1032	039903137N	6 PK 1100	06A109119A	KT 1301
036109181A	147ST	03C145933A	5 PK 491	06A109479	120ST
036109243AB	146ST	03C260849A	6 PK 1700	06A109479A	120ST
036109243AC	148ST	03C903137A	6 PK 1600	06A109479B	120ST
036109243AD	146ST	03D145933AD	6 PK 1880	06A109479C	120ST
036109243AE	148ST	03D145933AG	6 PK 1450	06A145933D	6 PK 1125
036109243AG	148ST	03D145933S	6 PK 1460	06A145933L	6 PK 925
036109243E	146ST	03E260849A	6 PK 1870	06A198119B	KT 1230
036109243F	385ST	03E260849B	6 PK 1870	06A260849B	6 DPK 1195
036109243K	148ST	03F260849A	6 PK 1690	06A260849C	6 DPK 1195
036109243L	146ST	03F903137A	6 PK 1432	06A260849E	6 DPK 1195
036109243R	146ST	03G109119	ZRK 1468	06A260849K	6 PK 1035
036109244C	145UT	03G109119B	ZRK 1468	06A903315D	135SR
036109244D	145UT	03G109243	423ST	06A903315E	135SR
036109244J	145UT	03G109244	424UT	06A903849K	6 PK 1035
036145933AE	6 PK 1190	03G903137A	6 PK 950	06B109243	230ST
036145933AG	6 PK 737	03G903137B	6 PK 1055	06B109243A	127ST
036145933AJ	6 PK 1078	03G903137H	6 PK 820	06B109243D	127ST
036145933F	6 PK 1090	03L109119	ZRK 1544	06B109244	156UT
036145933H	6 PK 1550	03L109119A	ZRK 1544	06B109477	136ST
036145933J	6 PK 1078	03L109119B	ZRK 1572	06B109479	136ST
036145933M	6 PK 745	03L109119C	ZRK 1572	06B198119	KT 1230
036198119	KT 1374	03L109119D	ZRK 1544	06D109119B	ZRK 1443
036198119B	KT 1374	03L109119E	ZRK 1572	06D903137C	6 PK 1570
036198119C	KT 1445	03L109119F	ZRK 1544	06D903137E	6 PK 1570
036198119E	KT 1209	03L109119G	ZRK 1572	06F198119A	KT 1432
036198119F	KT 1374	03L109119J	ZRK 1572	06F260849E	6 PK 1045
037198119	KT 1258	03L109243A	466ST	06F260849L	6 PK 1055
037260849	6 PK 1153	03L109244C	160UT	06F903137E	6 PK 900
037260849C	6 PK 1153	03L109244D	119UT	06F903137L	6 PK 955



Teilenummer Part number	Abmessung Dimension
----------------------------	------------------------

Teilenummer Part number	Abmessung Dimension
----------------------------	------------------------

Teilenummer Part number	Abmessung Dimension
----------------------------	------------------------

**SEAT**

06H121605E	ZRK 1585
06J260849D	6 PK 1115
071145933F	6 PK 1285
071145933N	6 DPK 1352
1H0119137	2 PJ 800
1H0119137A	2 PJ 860
1K0260849B	6 PK 1100
1L0198001	KT 1381
357119137E	2 PJ 800
357119137F	2 PJ 860
3897656	AVX 10 x 1000
3901232	AVX 10 x 775
3902990	AVX 13 x 825
3904815	AVX 13 x 775
3910824	AVX 13 x 1175
3910825	AVX 13 x 1475
3919416	AVX 13 x 1450
3938725	AVX 10 x 875
3938737	AVX 10 x 875
3939739	AVX 10 x 800
39404860	AVX 10 x 750
39530770	AVX 10 x 825
4146147	AVX 10 x 750
4156392	AVX 10 x 800
4156931	AVX 10 x 800
4164623	AVX 10 x 785
4164869	ZRK 1088
4253056	AVX 13 x 750
4365185	ZRK 1030
4367051	ZRK 1054
4406634	ZRK 1057
4418465	ZRK 1030
4420507	ZRK 1051
6K0198001A	KT 1034
6K0198001B	KT 1288
6K0198001D	KT 1032
6Q0260849A	6 PK 1735
6Q0903137A	6 PK 1090
EA03231005	AVX 10 x 750
EA03231006	AVX 10 x 750
EA03231007	AVX 10 x 750
FA01201203	ZRK 1030
FA03231000	AVX 10 x 775
FA03231001	AVX 10 x 775
FA03231002	AVX 10 x 775
FC03231001	AVX 10 x 850
FD03231000	AVX 10 x 800
FD03231001	AVX 10 x 850
FD03231002	AVX 10 x 850
GE04351000	ZRK 1031
HB03231000	AVX 10 x 785
SE020032310	AVX 10 x 800
SE021012012	ZRK 1124
SE021012060	463UT
SE02103931	AVX 13 x 975
SE021039310	AVX 13 x 975
SE021040210	AVX 10 x 750
SE021040210	AVX 10 x 750
SE700032310	AVX 10 x 838
SE700032310	AVX 10 x 825
SE700032310	AVX 10 x 838
SE70003231A	AVX 10 x 838
SE70003231B	AVX 10 x 838
X039402750	ZRK 1124
X039530760	AVX 10 x 838

**SEAT**

X039619190	463UT
X039652540	AVX 10 x 813
XE020032310	AVX 10 x 800
XE021012012	ZRK 1124
XE021040210	AVX 10 x 750
XE700032310	AVX 10 x 838
XO39530760	AVX 10 x 838
XO39652540	AVX 10 x 813

**SGM SAAB**

05492574	ZRK 1182
09128722	ZRK 1256
5492574	ZRK 1182
90571148	ZRK 1256
93386687	ZRK 1256

**SKODA**

005435171	4 PK 950
005435174	6 PK 1675
022145933AG	6 PK 1610
028109119AC	ZRK 1339
028109119N	ZRK 1339
028109243D	121ST
028109243E	128ST
028109243F	128ST
028109243G	121ST
028109244	111UT
028198119A	KT 1021
028198119C	KT 1358
028198119E	KT 1087
028198119G	KT 1326
028903137AP	5 PK 1219
030109243D	125ST
030109243F	125ST
030109243J	125ST
030109243K	125ST
030145933E	6 PK 1070
030145933G	6 PK 1070
030145933K	6 PK 1078
030145933L	6 PK 1070
030903137AB	6 PK 750
030903137T	6 PK 750
032145933AA	6 PK 1550
032145933S	6 PK 1125
032198119	KT 1032
036109119AC	ZRK 1001
036109119AG	ZRK 1001
036109181A	147ST
036109243AB	146ST
036109243AC	148ST
036109243AD	146ST
036109243AE	148ST
036109243AG	148ST
036109243E	146ST
036109243K	148ST
036109243L	146ST
036109243R	146ST
036109244C	145UT
036109244D	145UT
036109244J	145UT
036145933AG	6 PK 737
036145933AJ	6 PK 1078
036145933F	6 PK 1090
036145933H	6 PK 1550
036145933J	6 PK 1078

**SKODA**

036145933M	6 PK 745
036198119	KT 1374
036198119B	KT 1374
036198119C	KT 1445
036198119E	KT 1209
036198119F	KT 1374
038109119B	KT 1248
038109119N	ZRK 1338
038109119P	ZRK 1338
038109119S	ZRK 1338
038109243	155ST
038109243D	155ST
038109243F	155ST
038109243G	155ST
038109243H	155ST
038109243M	162ST
038109243N	155ST
038109244B	132UT
038109244C	132UT
038109244E	150UT
038109244H	132UT
038109244J	163UT
038109244M	132UT
038109244Q	150UT
038145276	140UR
038198119	KT 1238
038198119A	KT 1237
038198119C	KT 1237
038198119F	KT 1226
038903137AA	6 PK 1185
038903137E	6 PK 1660
038903137G	6 PK 906
038903137H	5 PK 1435
038903137J	6 PK 1660
038903137L	6 PK 1185
038903137M	6 PK 780
038903137N	6 PK 1100
038903137T	5 PK 1435
03C145933A	5 PK 491
03C260849A	6 PK 1700
03C903137A	6 PK 1600
03D145933A	6 PK 1748
03D145933AD	6 PK 1880
03D145933AG	6 PK 1450
03D145933AH	6 PK 1880
03D145933AJ	6 PK 1450
03D145933S	6 PK 1460
03E260849A	6 PK 1870
03E260849B	6 PK 1870
03F260849A	6 PK 1690
03F903137A	6 PK 1432
03G109119	ZRK 1468
03G109119B	ZRK 1468
03G109243	423ST
03G109244	424UT
03G903137A	6 PK 950
03G903137B	6 PK 1055
03G903137H	6 PK 820
03L109119	ZRK 1544
03L109119A	ZRK 1544
03L109119B	ZRK 1572
03L109119C	ZRK 1572
03L109119D	ZRK 1544
03L109119E	ZRK 1572
03L109119F	ZRK 1544



Teilenummer Part number	Abmessung Dimension
----------------------------	------------------------

Teilenummer Part number	Abmessung Dimension
----------------------------	------------------------

Teilenummer Part number	Abmessung Dimension
----------------------------	------------------------

**SKODA**

03L109119G	ZRK 1572
03L109119J	ZRK 1572
03L109243A	466ST
03L109244C	160UT
03L109244D	119UT
03L198119	KT 1420
03L903137	6 PK 1070
03L903137B	6 EPK 842
03L998037	6 EPK 842
045109243A	152ST
045109243C	152ST
045109243F	162ST
045109244A	160UT
045109479B	161ST
045903137B	6 PK 995
045903137D	6 PK 995
045903137E	6 PK 858
047145933	6 PK 1675
047145933E	6 PK 1675
047903137AB	6 PK 1748
047903137G	6 PK 1520
047903137R	5 PK 1219
058109244	119UT
058903133	134SR
058903133B	134SR
058903133C	134SR
058903133D	134SR
059109243D	244UT
059109243F	297ST
059109243G	297ST
059109243J	244UT
059109243L	297ST
059109244	415UT
059109244A	415UT
059109244B	415UT
059109479B	247ST
059109487A	248ST
059109487B	248ST
059109487C	248ST
068109243	101ST
068109243C	101ST
068109243F	101ST
06A109119A	KT 1301
06A109119B	ZRK 1216
06A109119C	ZRK 1216
06A109479	120ST
06A109479A	120ST
06A109479B	120ST
06A109479C	120ST
06A145933D	6 PK 1125
06A145933F	6 PK 925
06A198119B	KT 1230
06A260849	6 DPK 1195
06A260849C	6 DPK 1195
06A260849G	6 PK 1035
06A903315D	135SR
06A903315E	135SR
06B109243	230ST
06B109243A	127ST
06B109243B	157ST
06B109243D	127ST
06B109244	156UT
06B109477	136ST
06B109477A	158ST
06B109479	136ST

**SKODA**

06B198119	KT 1230
06B260849A	4 PK 855
06B260849B	4 PK 855
06B260849D	4 PK 855
06B903137	5 PK 1300
06B903137E	5 PK 1300
06D109119B	ZRK 1443
06F198119A	KT 1432
06F260849E	6 PK 1045
06F260849L	6 PK 1055
06F903137E	6 PK 900
06F903137L	6 PK 955
06H121605E	ZRK 1585
06J260849D	6 PK 1115
06Q903137A	6 PK 1090
078109243Q	137UT
078109243R	137UT
078109243S	137UT
078109244H	138UT
078109244J	138UT
078109479E	139ST
078109487A	235UT
078198479	KT 1304
078903137BC	6 PK 1880
101555435	AVX 10 x 925
101565435	AVX 10 x 1050
1K0260849A	6 PK 1100
1K0260849B	6 PK 1100
44105435	4 PK 950
441054351716	4 PK 950
6K0198001D	KT 1032
6Q0260849A	6 PK 1735
6Q0260849C	6 PK 1735
6Q0903137A	6 PK 1090
6U0903137A	4 PK 950
942092509	AVX 10 x 925
942100009	AVX 10 x 1000
942105009	AVX 10 x 1050
946095009	AVX 10 x 950

**SMART**

0003177V0030	4 PK 790
0003190V0050	3 PK 855
0009932396	5 PK 1219
0009932496	5 PK 920
0009932996	5 PK 1790
0018907V0010	4 PK 790
0018908V0010	3 PK 855
0019930796	4 PK 805
0019932896	5 PK 1790
0019934496	4 PK 805
1609970092	4 PK 790
1609970192	3 PK 855

**SSANGYONG**

0079978292	6 PK 2245
0089973492	6 PK 2120
0089973692	6 PK 2100
0109977192	6 PK 2040
0109978892	6 PK 2228
0119971592	6 PK 2100
0119971892	6 PK 2055
0119971992	6 PK 2155
0119974292	6 PK 2040
0119975292	6 PK 2155

**SSANGYONG**

1629973392	6 PK 2228
4714603050	AVX 13 x 1500
517039000	5 PK 905
6619974692	6 PK 2100
6659970392	6 PK 2255
6822603801	AVX 13 x 975

**SUBARU**

1276163E00	ZRK 1154
1276178400	ZRK 1034
13027AA102	ZRK 1284
13028AA027	ZRK 1311
13028AA040	ZRK 1284
13028AA071	ZRK 1311
13028AA072	ZRK 1311
13028AA101	ZRK 1284
13028AA102	ZRK 1284
13028AA181	ZRK 1320
13028AA200	ZRK 1311
13028AA230	ZRK 1320
13028AA240	ZRK 1311
13028KA020	ZRK 1154
13028KA021	ZRK 1154
13029AA010	ZRK 1230
13029AA011	ZRK 1230
13029AA080	ZRK 1230
13033AA000	173UT
13033AA001	173UT
13033AA002	173UT
13033AA040	173UT
13033AA042	173UT
13069AA034	290UT
13069AA035	290UT
13069AA036	290UT
13069AA037	290UT
13069AA060	171UT
13069AA062	171UT
13069AA063	171UT
13073AA080	291UT
13073AA081	291UT
13073AA082	291UT
13073AA140	291UT
13073AA142	291UT
13073AA180	291UT
13073AA190	434UT
13073AA200	172UT
13085AA010	292UT
13085AA080	292UT
13160AA060	ZRK 1311
13160AA110	ZRK 1311
13160KA070	ZRK 1034
1752152E00	4 PK 950
1752160B00	3 PK 815
1752160B20	3 PK 815
1752161A00	4 PK 805
1752186500	4 PK 813
1752186520	4 PK 813
4147054A01	ZRK 1258
414705601	ZRK 1034
414705701	ZRK 1034
4918060B20	4 PK 850
73013AA000	4 PK 884
73013PA000	4 PK 855
73013TA070	4 PK 962
73036GA100	4 PK 985



Teilenummer Part number	Abmessung Dimension
----------------------------	------------------------

Teilenummer Part number	Abmessung Dimension
----------------------------	------------------------

Teilenummer Part number	Abmessung Dimension
----------------------------	------------------------

**SUBARU**

73036GA110	4 PK 1125
73036GA120	AVX 13 x 975
73036GA130	AVX 13 x 1150
73036GA140	AVX 13 x 950
73036GA150	AVX 13 x 1100
731056000	AVX 13 x 1250
73323AA010	4 PK 900
73323AC000	4 PK 900
73323AC010	4 PK 900
73323AC011	4 PK 900
73323AP010	4 PK 900
73323FA000	4 PK 884
73323FA030	4 PK 884
73323FA031	4 PK 884
73323SA000	4 PK 855
8081101100	AVX 10 x 675
809110010	AVX 10 x 775
809110030	AVX 10 x 763
809110050	AVX 10 x 940
809110060	AVX 10 x 775
809110110	AVX 10 x 675
809110140	AVX 10 x 913
809110150	AVX 10 x 715
809110250	AVX 10 x 900
809110280	AVX 10 x 900
809110290	AVX 10 x 900
809110310	AVX 10 x 925
809110320	AVX 10 x 675
809110330	AVX 10 x 715
809110370	AVX 10 x 913
809110380	AVX 10 x 900
809110400	AVX 10 x 700
809110410	AVX 10 x 675
809110550	AVX 10 x 700
809113020	AVX 13 x 975
809113050	AVX 13 x 925
809211010	3 PK 648
809211020	3 PK 735
809213010	4 PK 980
809213040	4 PK 950
809214070	4 PK 725
809214290	4 PK 725
809214320	4 PK 705
809214470	4 PK 845
809214550	4 PK 845
809218130	5 PK 880
809218140	5 PK 880
809218150	5 PK 880
809218160	5 PK 880
809218170	5 PK 880
809218200	5 PK 886
809218210	5 PK 880
809218240	5 PK 886
809218250	5 PK 880
809218270	5 PK 880
809218300	5 PK 880
809218310	5 PK 880
809218340	5 PK 870
809218350	5 PK 870
809218380	5 PK 880
809218390	5 PK 880
809218400	5 PK 870
809218410	5 PK 870
809218420	5 PK 870
809218430	5 PK 880

**SUBARU**

809218750	5 PK 880
809221050	6 PK 1642
809221080	6 PK 1590
809221090	6 PK 1625
809221120	6 PK 1650
809H0410	AVX 10 x 675
809H3050	AVX 13 x 925
9514150F01	4 PK 835
9514163B50	4 PK 790
G3012AA608	4 PK 884
G3031FA613	5 PK 970

**SUZUKI**

1140760A00	ZRK 1158
1140760E00	ZRK 1061
1140763B00	ZRK 1035
1140770C00	ZRK 1295
1140771C00	ZRK 1161
1176163E00	ZRK 1154
1276153B00	ZRK 1173
1276160A00	ZRK 1158
1276160A01	ZRK 1158
1276160B01	ZRK 1308
1276160B10	ZRK 1308
1276160E00	ZRK 1061
1276163B00	ZRK 1035
1276163E00	ZRK 1154
1276167G00	ZRK 1352
1276167J00	ZRK 1441
1276167J0000	ZRK 1441
1276170C00	ZRK 1295
1276171C00	ZRK 1161
1276172F00	ZRK 1296
1276173000	ZRK 1033
1276173001	ZRK 1033
1276173J00	ZRK 1453
1276175500	ZRK 1158
1276178400	ZRK 1034
1276180C00	ZRK 1154
1276182000	ZRK 1035
1276182010	ZRK 1035
127618E01	ZRK 1225
12761M72F10	ZRK 1296
12761M84400	ZRK 1034
12761M84410	ZRK 1543
12761M84430	ZRK 1543
1281053A00	176ST
1281053B00	392UT
1281053B01	392UT
1281066G00	274ST
1281066G000	274ST
1281067G01	250UT
1281067G10	431ST
1281067G100	431ST
1281071C00	181UT
1281071C01	181UT
1281071C02	181UT
1281073001	176ST
1281073002	176ST
1281073003	176ST
1281073J01	331ST
1281073J0100	331ST
1281082000	900UT
1281082001	900UT
1281082002	900UT

**SUZUKI**

1281082003	900UT
1281084000	176ST
1281084001	176ST
1281086500	389UT
1281086501	389UT
1281086CA0	277UT
1282366G00	277UT
1282366G000	277UT
1282367G01	293UT
1282367G01	KT 1433
1282367G10	432UT
1282367G100	432UT
1282373J00	332UT
1282373J0000	332UT
1283086CA0	274ST
175171520	AVX 10 x 775
17521052E00	4 PK 950
1752124J00	5 PK 835
1752151A00	4 PK 813
1752152E00	4 PK 950
1752160A00	4 PK 813
1752160B00	3 PK 815
1752160B01	3 PK 815
1752160B10	3 PK 815
1752160B20	3 PK 815
1752161A00	4 PK 805
1752161A10	4 PK 805
1752162G00	5 PK 1545
1752163250	AVX 10 x 775
1752164J00	5 PK 835
1752165050	AVX 10 x 763
1752166J00	4 PK 950
1752167JA0	7 PK 1385
1752175100	AVX 10 x 775
1752176000	AVX 10 x 825
1752177300	AVX 10 x 750
1752177E00	5 PK 1545
1752177E10	5 PK 1545
1752177E20	5 PK 1545
1752178000	AVX 10 x 813
1752178F00	4 PK 813
1752178K00	6 PK 2050
1752179J50	6 PK 1055
1752179K00	6 PK 2170
1752180F51	4 PK 1040
1752181AA0	4 PK 985
1752182010	AVX 10 x 838
1752182030	AVX 10 x 838
1752183010	AVX 10 x 838
1752183030	AVX 10 x 838
1752183AA0	4 PK 995
1752183E00	4 PK 813
1752184CA0	6 PK 1115
1752184H00	4 PK 850
1752185090	4 PK 1080
1752185300	4 PK 1015
1752185C00	4 PK 813
1752185E00	6 PK 1185
1752185FA0	4 PK 925
1752186500	4 PK 813
1752186510	4 PK 813
1752186520	4 PK 813
17521882030	AVX 10 x 838
17521M68K00	4 PK 900
17521M79F10	4 PK 705

Teilenummer Part number	Abmessung Dimension	Teilenummer Part number	Abmessung Dimension	Teilenummer Part number	Abmessung Dimension
<b>SUZUKI</b>		<b>SUZUKI</b>		<b>TATA (TELCO)</b>	
3534086CA0	6 PK 1145	9514186H00	4 PK 763	254715146321	4 PK 1050
395464985	6 PK 1318	95141M68K00	4 PK 790	254715146332	4 PK 1040
4818052E00	4 PK 950	95141M79F00	3 PK 750	254723126309	6 PK 1318
4918060B10	4 PK 950	96198509	6 PK 1145	254723126320	6 PK 1318
4918060B20	4 PK 850	96209040	6 PK 1145	254723126329	6 PK 1345
4918060G10	4 PK 900	9936380740	3 PK 740	254723126330	6 PK 1360
4918063B10	4 PK 920	<b>TALBOT</b>		278923116302	6 PK 1153
4918063B20	4 PK 825	0013014900	AVX 10 x 785	279015146310	4 PK 715
4918063B50	4 PK 790	0042794400	AVX 10 x 913	279023116304	4 PK 875
4918063G10	4 PK 913	0042794500	AVX 10 x 864	279023116307	4 PK 875
4918065G10	6 PK 1740	0043538000	AVX 10 x 875	279023126306	4 PK 725
4918065G11	6 PK 1725	0055421100	AVX 10 x 900	279023126311	4 PK 725
4918065G20	6 PK 1153	0522066100	AVX 10 x 785	279123116302	5 PK 1070
4918069G00	4 PK 940	1238402	AVX 10 x 960	<b>TOYOTA</b>	
4918073J00	6 PK 1375	1238562	AVX 10 x 935	1276178400	ZRK 1034
4918084A80	6 PK 1965	1238562	AVX 10 x 938	13208AA200	ZRK 1433
4918086000	4 PK 940	128007	AVX 10 x 1125	1350301010	825ST
4918150J40	6 PK 1635	13014900	AVX 10 x 785	1350310010	839ST
4918156B10	4 PK 813	179439	AVX 10 x 775	1350310011	827UT
4918160A00	4 PK 790	20454400	AVX 10 x 1050	1350310021	827UT
4918164J00	4 PK 890	20454500A	AVX 10 x 1050	135031002100	827UT
4918165D40	6 PK 1570	22100Z	AVX 13 x 1060	1350311030	829UT
4918170A10	4 PK 705	26181A	AVX 10 x 888	1350311040	829UT
4918177E00	4 PK 1020	30405T	AVX 13 x 1075	1350327010	420UT
51758124	6 PK 1390	347100	AVX 10 x 785	1350354010	837UT
55185078	6 PK 1318	36942N	AVX 10 x 785	1350354020	837UT
8200059395	6 PK 1138	400332	AVX 10 x 1050	1350354030	833UT
9008090155	5 PK 970	400365	AVX 10 x 800	1350363010	814UT
9091602299	4 PK 805	400366	AVX 10 x 775	1350363011	814UT
9091602422	5 PK 1125	400398	AVX 10 x 850	1350363020	814UT
9091602424	4 PK 870	400906	AVX 10 x 1025	1350363021	814UT
9091602433	4 PK 870	407601	AVX 10 x 975	1350364010	816UT
9091602995	5 PK 1130	409105	AVX 10 x 975	1350364020	816UT
9414160G90	5 PK 1645	409224	AVX 10 x 785	1350364021	816UT
9497000730	4 PK 925	40996V	AVX 10 x 925	1350370040	814UT
9497000740	4 PK 940	427169	AVX 10 x 864	1350388360	814UT
9514150F00	4 PK 835	427944	AVX 10 x 913	1350388361	814UT
9514150F01	4 PK 835	427945	AVX 10 x 913	1350388380	814UT
9514151K00	4 PK 763	456908	AVX 10 x 650	1350388560	814UT
9514155C00	4 PK 750	456909	AVX 10 x 600	1350501010	825ST
9514155C10	4 PK 855	456911	AVX 10 x 617	1350501011	826ST
9514157B50	4 PK 825	456912	AVX 10 x 550	1350502030	830ST
9514157B60	4 PK 925	456914	AVX 10 x 600	1350510010	838ST
9514160A00	4 PK 825	456916	AVX 10 x 613	1350511010	826ST
9514160A10	4 PK 940	522066100	AVX 10 x 785	1350511011	826ST
9514160A50	4 PK 805	55421100	AVX 10 x 900	1350511020	826ST
9514160A60	4 PK 920	574926	AVX 10 x 975	1350511040	828ST
9514160B10	4 PK 950	575055	4 PK 698	1350511050	828ST
9514160B50	4 PK 763	7100127	AVX 10 x 1110	1350515020	825ST
9514160G40	4 PK 995	7100127A	AVX 10 x 1100	1350515031	825ST
9514160G50	4 PK 841	71266250	AVX 10 x 965	1350515040	825ST
9514160G60	4 PK 1005	71266255	AVX 10 x 838	1350515041	825ST
9514160G80	5 PK 1645	71803371	AVX 10 x 813	1350515050	830ST
9514160G90	5 PK 1645	75221594	AVX 10 x 960	1350515060	830ST
9514163B50	4 PK 790	75221595	AVX 10 x 813	1350527010	419ST
9514164A00	4 PK 841	9151357980	ZRK 1125	1350527010F	419ST
9514164A10	4 PK 950	9226505	AVX 10 x 965	1350554010	836ST
9514165D00	4 PK 1090	9226506	AVX 10 x 965	1350554020	832ST
9514167D00	5 PK 1645	9350050180	AVX 10 x 750	1350554021	832ST
9514170F01	4 PK 835	9750987880	AVX 10 x 700	1350563010	835ST
9514173J00	6 PK 1718	<b>TATA (TELCO)</b>		1350563011	835ST
9514183C10	4 PK 775	254715146314	4 PK 1050	1350563021	835ST
9514184A00	6 PK 2120	254715146315	4 PK 1050	1350564011	815ST
9514184EA0	6 PK 1318			1350564012	815ST
9514185C60	4 PK 940				





Teilenummer Part number	Abmessung Dimension
----------------------------	------------------------

Teilenummer Part number	Abmessung Dimension
----------------------------	------------------------

Teilenummer Part number	Abmessung Dimension
----------------------------	------------------------

## TOYOTA

## TOYOTA

## TOYOTA

1350564020	815ST
1350564021	815ST
1350574010	831ST
1350574011	831ST
1350574021	831ST
1356803010	ZRK 1227
1356803020	ZRK 1227
1356809020	ZRK 1003
1356809030	ZRK 1004
1356809040	ZRK 1227
1356809041	ZRK 1227
1356809130	ZRK 1580
135680L010	ZRK 1580
1356811010	ZRK 1005
1356811020	ZRK 1005
1356811050	ZRK 1006
1356811051	ZRK 1006
1356811052	ZRK 1006
1356811053	ZRK 1006
1356811070	ZRK 1005
1356811071	ZRK 1005
1356811080	ZRK 1007
1356811081	ZRK 1007
1356815010	ZRK 1034
1356815040	ZRK 1037
1356815041	ZRK 1037
1356815042	ZRK 1037
1356815050	ZRK 1037
1356816010	ZRK 1126
1356816020	ZRK 1126
1356816040	ZRK 1003
1356816050	ZRK 1003
1356816051	ZRK 1003
1356816060	ZRK 1004
1356816070	ZRK 1004
1356817010	ZRK 1105
13568-17020	ZRK 1569
13568-17021	ZRK 1569
1356819025	ZRK 1006
1356819045	ZRK 1003
1356819046	ZRK 1003
1356819055	ZRK 1004
1356819056	ZRK 1004
1356819065	ZRK 1105
1356819095	ZRK 1005
1356819105	ZRK 1007
1356819106	ZRK 1007
1356819125	ZRK 1034
1356819135	ZRK 1037
1356819145	ZRK 1126
1356819165	ZRK 1005
13568-19175	ZRK 1569
13568-19176	ZRK 1569
1356819185	ZRK 1003
1356820020	ZRK 1323
1356827010	ZRK 1447
1356829015	ZRK 1323
1356829025	ZRK 1323
1356829035	ZRK 1447
1356830010	ZRK 1580
1356839010	ZRK 1580
1356839015	ZRK 1580
1356839016	ZRK 1580
1356854010	ZRK 1059
1356854020	ZRK 1059

1356854030	ZRK 1059
1356854038	ZRK 1059
1356854050	ZRK 1136
1356854051	ZRK 1136
1356854060	ZRK 1136
1356854070	ZRK 1134
1356854071	ZRK 1134
1356854080	ZRK 1134
1356854090	ZRK 1136
1356859015	ZRK 1059
1356859016	ZRK 1059
1356859017	ZRK 1059
1356859025	ZRK 1136
1356859026	ZRK 1136
1356859027	ZRK 1136
1356859065	ZRK 1134
1356859066	ZRK 1134
1356859075	ZRK 1136
1356859106	ZRK 1134
1356863010	ZRK 1085
1356863020	ZRK 1085
1356863022	ZRK 1085
1356863023	ZRK 1085
1356864010	ZRK 1148
1356864011	ZRK 1148
1356869045	ZRK 1085
1356869065	ZRK 1148
1356869066	ZRK 1148
1356874010	ZRK 1227
1356874011	ZRK 1227
1356874012	ZRK 1227
1356874013	ZRK 1227
1356874020	ZRK 1227
1356879025	ZRK 1227
1356879045	ZRK 1255
1356879095	ZRK 1227
1356879215	ZRK 1227
1356879225	ZRK 1227
1356887103	ZRK 1159
1356887104	ZRK 1159
1356887183	ZRK 1159
1356887184	ZRK 1159
1356888361	ZRK 1255
1356888381	ZRK 1255
1356888382	ZRK 1255
38920PWAJ01	5 PK 1155
50840	AVX 10 x 838
50885	AVX 10 x 888
5490460N	AVX 10 x 838
6PK1675	6 PK 1675
6PK1720	6 PK 1718
9008021040	6 PK 1038
9008090155	5 PK 970
9008091049	5 PK 1110
9008091050	5 PK 970
9008091051	3 PK 630
9008091054	3 PK 750
9008091055	5 PK 970
9008091078	3 PK 630
9008091079	3 PK 763
9008091082	5 PK 890
9008091087	6 PK 1035
9008091088	4 PK 875
9008091090	4 PK 1050
9008091092	4 PK 940

9008091093	4 PK 875
9008091099	5 PK 1110
9008091101	4 PK 1100
9008091121	6 PK 1940
9008091133	5 PK 1110
9008091134	6 PK 1540
9008091147	6 PK 1038
9008091168	6 PK 1930
9008091170	4 PK 850
9008091196	6 PK 1775
9008091198	6 PK 780
9008091199	6 PK 1730
9008091212	4 PK 875
9008091214	7 PK 1933
9008091223	6 PK 1765
9009982018	5 PK 1055
9036300890	3 PK 945
9086010700	AVX 10 x 1075
9086010700	AVX 10 x 1075 TM
9086109800	AVX 13 x 975
9087108905	AVX 13 x 900
9087109705	AVX 13 x 975
9089511800	AVX 13 x 1200
9091602024	AVX 10 x 864
9091602039B	AVX 10 x 838
9091602044	AVX 13 x 1075
9091602045	AVX 13 x 1075
9091602052	AVX 13 x 900
9091602055	AVX 13 x 900
9091602060	AVX 13 x 900
9091602061	AVX 13 x 900
90916-02070	AVX 10 x 935
90916-02070	AVX 10 x 938
9091602074	AVX 10 x 900
9091602076	AVX 10 x 925
9091602078	AVX 13 x 1225
9091602080	AVX 13 x 825
9091602092	AVX 10 x 1125
9091602098	AVX 10 x 965
9091602107	AVX 13 x 1200
9091602113	AVX 13 x 800
9091602116	5 PK 1104
9091602119	AVX 10 x 975
9091602122	3 PK 800
9091602123	AVX 10 x 960
9091602123	AVX 10 x 965
9091602125	AVX 10 x 850
9091602133	AVX 13 x 1000
9091602135	4 PK 813
9091602136	4 PK 813
9091602140	AVX 13 x 835
9091602144	AVX 13 x 975
9091602146	4 PK 1260
9091602147	5 PK 940
9091602148	5 PK 830
9091602149	5 PK 830
9091602154	AVX 10 x 775
9091602157	5 PK 950
9091602158	5 PK 850
9091602169	AVX 13 x 1000
9091602173	5 PK 985
9091602177	3 PK 763
9091602183	AVX 13 x 1000
9091602184	5 PK 850
9091602185	5 PK 850



Teilenummer Part number	Abmessung Dimension	Teilenummer Part number	Abmessung Dimension	Teilenummer Part number	Abmessung Dimension
<b>TOYOTA</b>		<b>TOYOTA</b>		<b>TOYOTA</b>	
9091602186	5 PK 880	9091602356	5 PK 1000	9091602507	5 PK 1219
9091602191	5 PK 1060	9091602357	5 PK 1015	9091602508	5 PK 1180
9091602192	5 PK 1060	9091602358	5 PK 1015	9091602509	5 PK 1110
9091602194	4 PK 1180	9091602360	6 PK 2245	9091602510	7 PK 1150
9091602196	AVX 13 x 1200	9091602361	6 PK 2270	9091602511	7 PK 1640
9091602197	5 PK 1104	9091602363	3 PK 800	9091602513	7 PK 1933
9091602200	4 PK 845	9091602364	4 PK 845	9091602515	7 PK 1920
9091602201	5 PK 1055	9091602365	4 PK 875	9091602516	6 PK 1670
9091602203	5 PK 1210	9091602370	5 PK 1030	9091602517	5 PK 886
9091602204	5 PK 1210	9091602372	AVX 13 x 950	9091602521	3 PK 850
9091602205	3 PK 763	9091602373	6 PK 1055	9091602522	3 PK 850
9091602207	5 PK 1125	9091602374	6 PK 1055	9091602523	7 PK 1093
9091602209	AVX 13 x 1050	9091602378	4 PK 1180	9091602524	7 PK 1473
9091602212	4 PK 825	9091602380	7 PK 2276	9091602533	5 PK 1240
9091602216	5 PK 1015	9091602382	5 PK 1104	9091602534	6 PK 1885
9091602219	5 PK 1000	9091602383	5 PK 1104	9091602535	6 PK 1540
9091602221	4 PK 920	9091602384	4 PK 1180	9091602537	6 PK 1695
9091602223	4 PK 950	9091602386	4 PK 875	9091602539	6 PK 1400
9091602231	6 PK 2245	9091602392	6 PK 1138	9091602540	6 PK 1940
9091602232	5 PK 950	9091602395	5 PK 1125	9091602545	6 PK 1420
9091602235	AVX 13 x 1050	9091602396	5 PK 1125	9091602546	6 PK 1695
9091602237	AVX 13 x 950	9091602399	3 PK 835	9091602547	6 PK 1880
9091602238	5 PK 865	9091602401	6 PK 1035	9091602549	6 PK 1695
9091602246	5 PK 1140	9091602402	5 PK 1025	9091602550	5 PK 1250
9091602248	AVX 10 x 1000	9091602403	5 PK 1025	9091602555	6 PK 1900
9091602256	5 PK 1104	9091602404	6 PK 2228	9091602557	7 PK 935
9091602257	5 PK 1104	9091602405	6 PK 2228	9091602558	7 PK 1175
9091602262	AVX 13 x 850	9091602410	4 PK 825	9091602559	6 PK 1730
9091602265	4 PK 825	9091602412	6 PK 1930	9091602560	4 PK 1770
9091602267	4 PK 835	9091602422	5 PK 1125	9091602561	4 PK 1710
9091602268	4 PK 875	9091602424	4 PK 870	9091602566	4 PK 1770
9091602269	4 PK 875	9091602430	5 PK 1070	9091602569	4 PK 1170
9091602270	5 PK 1110	9091602432	6 PK 1885	9091602570	3 PK 860
9091602273	AVX 10 x 775	9091602433	4 PK 870	9091602574	6 PK 1700
9091602281	AVX 10 x 975	9091602440	6 PK 2215	9091602575	3 PK 850
9091602293	5 PK 1015	9091602441	6 PK 2215	9091602585	6 PK 2240
9091602294	5 PK 1015	9091602458	6 PK 1885	9091602586	6 PK 2245
9091602295	5 PK 1000	9091602462	6 PK 2260	9091602596	7 PK 1595
9091602296	5 PK 1000	9091602463	6 PK 2245	9091602597	7 PK 1595
9091602298	4 PK 805	9091602464	6 PK 2228	9091602598	7 PK 1933
9091602299	4 PK 805	9091602467	5 PK 1090	9091602600	7 PK 1920
9091602301	AVX 13 x 950	9091602468	6 PK 1540	9091602601	7 PK 1920
9091602302	4 PK 1180	9091602469	6 PK 1560	9091602602	6 PK 870
9091602303	5 PK 970	9091602470	6 PK 1840	9091602606	6 PK 1210
9091602305	6 PK 1950	9091602471	4 PK 1075	9091602630	6 PK 1920
9091602308	6 PK 1975	9091602475	4 PK 1770	9091602639	7 PK 1870
9091602309	6 PK 1940	9091602476	4 PK 1770	9091602640	7 PK 2283
9091602310	6 PK 1940	9091602477	4 PK 1710	9091602641	3 PK 763
9091602314	3 PK 740	9091602478	4 PK 1710	9091602647	5 PK 1190
9091602318	3 PK 750	9091602482	6 PK 1820	9091602650	6 PK 1240
9091602319	4 PK 825	9091602486	6 PK 1695	9091602664	6 PK 1230
9091602320	4 PK 813	9091602487	6 PK 1400	9091602669	4 PK 841
9091602330	AVX 10 x 1000	9091602490	7 PK 1970	9091602673	6 PK 925
9091602332	4 PK 813	9091602491	7 PK 1595	9091602674	6 PK 1185
9091602335	6 PK 2020	9091602492	6 PK 1910	9091602995	5 PK 1130
9091602336	5 PK 865	9091602493	7 PK 1920	9091620820	4 PK 825
9091602337	5 PK 865	9091602494	7 PK 1595	9091691088	6 PK 1940
9091602341	4 PK 825	9091602495	5 PK 1130	90916A2007	6 PK 1940
9091602344	5 PK 1110	9091602499	4 PK 920	90916T2005	7 PK 1093
9091602345	5 PK 1110	9091602500	4 PK 1180	90916T2006	7 PK 1515
9091602348	4 PK 920	9091602501	4 PK 1180	90916T2014	7 PK 1933
9091602350	4 PK 805	9091602502	7 PK 1933	90916W2001	6 PK 970
9091602352	4 PK 805	9091602503	7 PK 1933	90916W2002	6 PK 1210
9091602354	4 PK 860	9091602504	6 PK 1870	90916W2003	6 PK 850
9091602355	5 PK 1000	9091602506	6 PK 1820	90916W2004	6 PK 1730



Teilenummer Part number	Abmessung Dimension
----------------------------	------------------------

Teilenummer Part number	Abmessung Dimension
----------------------------	------------------------

Teilenummer Part number	Abmessung Dimension
----------------------------	------------------------

## TOYOTA

90916W2005	6 PK 1560
90916W2006	6 PK 1870
90916W2007	6 PK 1420
90916W2008	6 PK 1695
90916W2010	7 PK 2000
90916W2011	6 PK 1245
90916W2013	7 PK 1370
90916W2014	7 PK 1870
90916W2015	6 PK 1760
90916W2017	6 PK 1760
90916W2018	6 PK 1230
90916WX001	6 PK 800
90916WX002	6 PK 962
9184007203	4 PK 715
9184008603	4 PK 860
9185008804	5 PK 880
9185011909	5 PK 1190
9185012103	5 PK 1210
94854403	ZRK 1003
94854404	ZRK 1004
96368342	6 PK 1775
9649006280	6 PK 962
9652945780	6 PK 962
9932100805	AVX 10 x 800
9932100810	AVX 10 x 800
9932100840	AVX 10 x 838
993210084083	AVX 10 x 838
9932100850	AVX 10 x 850
9932100851	AVX 10 x 850
9932100860	AVX 10 x 864
9932100870	AVX 10 x 875
9932100885	AVX 10 x 888
9932100895	AVX 10 x 900
9932100898	AVX 10 x 900
9932100985	AVX 10 x 990
9932110835	AVX 10 x 838
9932110843	AVX 10 x 838
9932150840	AVX 10 x 838
9932150895	AVX 10 x 900
9932150975	AVX 10 x 975
9932150985	AVX 10 x 990
9932150995	AVX 10 x 990
9932200805	AVX 13 x 825
9932200860	AVX 13 x 850
9932200880	AVX 13 x 875
9932200900	AVX 13 x 900
9932200910	AVX 13 x 925
9932200920	AVX 13 x 925
9932200940	AVX 13 x 950
9932200950	AVX 13 x 950
9932200960	AVX 13 x 975
9932200980	AVX 13 x 975
9932201045	AVX 13 x 1050
9932201250	AVX 13 x 1250
9932201375	AVX 13 x 1375
9932201400	AVX 13 x 1400
9932210875	AVX 13 x 875
9932211250	AVX 13 x 1250
9932250875	AVX 13 x 875
9932250985	AVX 13 x 985
9932251250	AVX 13 x 1250
9933100870	AVX 10 x 875
9933100880	AVX 10 x 888
9933100890	AVX 10 x 888
9933110841	AVX 10 x 838

## TOYOTA

9933110870	AVX 10 x 875
9933200805	AVX 13 x 800
9933200850	AVX 13 x 850
9933200900	AVX 13 x 900
9933200905	AVX 13 x 900
9933200980	AVX 13 x 985
9933200985	AVX 13 x 1000
9933200985	AVX 13 x 985
9933201055	AVX 13 x 1050
9933201360	AVX 13 x 1375
9933201395	AVX 13 x 1400
9933210820	AVX 13 x 825
9933210860	AVX 13 x 865
9933210865	AVX 13 x 865
9933210865	AVX 13 x 875
9933210870	AVX 13 x 875
9933210890	AVX 13 x 900
9933210905	AVX 13 x 900
9933211000	AVX 13 x 1000
9933211120	AVX 13 x 1125
9933211205	AVX 13 x 1200
9933211495	AVX 13 x 1500
9933251130	AVX 10 x 1125
9933251135	AVX 13 x 1125
9933260975	AVX 10 x 960
9933260975	AVX 10 x 965
9933261205	AVX 13 x 1200
9934150840	AVX 10 x 838
9934201095	AVX 13 x 1100
9934201100	AVX 13 x 1100
9934201115	AVX 13 x 1100
9934311090	X17 x 1080
9936300630	3 PK 630
9936300750	3 PK 750
9936300760	3 PK 763
9936300800	3 PK 800
9936300890	3 PK 890
9936300950	3 PK 945
9936300960	3 PK 960
9936300970	3 PK 975
9936310630	3 PK 630
9936320630	3 PK 630
9936320750	3 PK 750
9936320760	3 PK 763
9936330630	3 PK 630
9936330750	3 PK 750
9936330760	3 PK 763
9936330850	3 PK 850
9936331120	3 PK 1120
9936350630	3 PK 630
9936350760	3 PK 763
9936350975	3 PK 975
9936351110	5 PK 1110
9936370630	3 PK 630
9936370760	3 PK 763
9936380630	3 PK 630
9936380750	3 PK 750
9936380760	3 PK 763
9936390630	3 PK 630
9936390750	3 PK 750
9936390760	3 PK 763
9936390850	3 PK 850
9936391120	3 PK 1120
9936400720	4 PK 715
9936400770	4 PK 775

## TOYOTA

9936400790	4 PK 790
9936400800	4 PK 805
9936400840	4 PK 841
9936400845	4 PK 845
9936400850	4 PK 850
9936400860	4 PK 860
9936400870	4 PK 870
9936400890	4 PK 890
9936400910	4 PK 913
9936400920	4 PK 920
9936400930	4 PK 925
9936400940	4 PK 940
9936400970	4 PK 970
9936400980	4 PK 980
9936401080	4 PK 1080
9936401090	4 PK 1090
9936401100	4 PK 1100
9936410850	4 PK 850
9936420720	4 PK 715
9936420770	4 PK 775
9936420790	4 PK 790
9936420820	4 PK 825
9936420830	4 PK 835
9936420840	4 PK 841
9936420850	4 PK 850
9936420860	4 PK 860
9936420870	4 PK 870
9936420880	4 PK 875
9936420890	4 PK 890
9936420900	4 PK 900
9936420920	4 PK 920
9936420930	4 PK 925
9936420940	4 PK 940
9936421070	4 PK 1075
9936421090	4 PK 1090
9936421110	4 PK 1110
9936421120	4 PK 1125
9936430770	4 PK 775
9936430850	4 PK 850
9936430860	4 PK 860
9936430900	4 PK 900
9936430940	4 PK 940
9936431110	4 PK 1100
9936431240	4 PK 1237
9936450720	4 PK 715
9936450810	4 PK 813
9936450830	4 PK 835
9936450840	4 PK 841
9936450880	4 PK 875
9936450890	4 PK 890
9936450900	4 PK 900
9936450940	4 PK 940
9936451070	4 PK 1075
9936451100	4 PK 1100
9936451110	4 PK 1110
9936451160	4 PK 1165
9936451170	4 PK 1170
9936451200	4 PK 1190
9936470720	4 PK 715
9936470830	4 PK 835
9936470840	4 PK 841
9936470860	4 PK 860
9936470890	4 PK 890
9936470970	4 PK 970
9936471100	4 PK 1100





Teilenummer Part number	Abmessung Dimension	Teilenummer Part number	Abmessung Dimension	Teilenummer Part number	Abmessung Dimension
<b>TOYOTA</b>		<b>TOYOTA</b>		<b>TOYOTA</b>	
9936480720	4 PK 715	9936521190	5 PK 1190	9936581210	5 PK 1210
9936480750	4 PK 750	9936521210	5 PK 1210	9936581220	5 PK 1219
9936480810	4 PK 813	9936521220	5 PK 1219	9936590890	5 PK 890
9936480820	4 PK 825	9936531080	5 PK 1080	9936590910	5 PK 905
9936480830	4 PK 835	9936531090	5 PK 1090	9936591090	5 PK 1090
9936480850	4 PK 850	9936531100	5 PK 1104	9936591110	5 PK 1110
9936480860	4 PK 860	9936531110	5 PK 1110	9936591120	5 PK 1125
9936480880	4 PK 875	9936531120	5 PK 1125	9936591190	5 PK 1190
9936480910	4 PK 913	9936531130	5 PK 1130	9936591240	5 PK 1240
9936480930	4 PK 925	9936531210	5 PK 1210	99365A0930	5 PK 935
9936481070	4 PK 1075	9936550790	5 PK 790	99365A1190	5 PK 1190
9936481080	4 PK 1080	9936550820	5 PK 820	99365C0930	5 PK 935
9936481100	4 PK 1100	9936550830	5 PK 830	99365C1110	5 PK 1110
9936481110	4 PK 1110	9936550870	4 PK 870	99365C1190	5 PK 1190
9936481120	4 PK 1125	9936550880	5 PK 880	99365D1110	5 PK 1110
9936481770	4 PK 1770	9936550890	5 PK 890	99365D1190	5 PK 1190
9936490880	4 PK 875	9936550895	5 PK 900	9936601050	6 PK 1055
9936490920	4 PK 920	9936550900	5 PK 900	9936620780	6 PK 780
9936490930	4 PK 925	9936550910	5 PK 905	9936621040	6 PK 1038
9936490940	4 PK 940	9936550920	5 PK 920	9936621050	6 PK 1055
9936491080	4 PK 1080	9936550930	5 PK 935	9936631040	6 PK 1038
9936491180	4 PK 1180	9936550940	5 PK 940	9936631040	6 PK 1045
99364C1050	4 PK 1050	9936550950	5 PK 950	9936631820	6 PK 1820
99364H1390	4 PK 1390 TM	9936550960	5 PK 970	9936650820	6 PK 820
9936500780	5 PK 775	9936550970	5 PK 970	9936650940	6 PK 935
9936500790	5 PK 790	9936551000	5 PK 1000	9936670820	6 PK 820
9936500800	5 PK 805	9936551050	5 PK 1055	9936671050	6 PK 1055
9936500825	5 PK 830	9936551070	5 PK 1070	9936680730	6 PK 730
9936500830	5 PK 830	9936551080	5 PK 1080	9936680780	6 PK 780
9936500860	5 PK 860	9936551100	5 PK 1104	9936680820	6 PK 820
9936500870	5 PK 870	9936551110	5 PK 1110	9936680940	6 PK 935
9936500880	5 PK 880	9936551120	5 PK 1125	9936690820	6 PK 820
9936500900	5 PK 900	9936551130	5 PK 1130	99366A0780	6 PK 780
9936500930	5 PK 935	9936551210	5 PK 1210	99366C0970	6 PK 970
9936500970	5 PK 970	9936551290	5 PK 1290	99366C1040	6 PK 1045
9936500980	5 PK 975	9936551300	5 PK 1300	99366C1220	6 PK 1215
9936501000	5 PK 1000	9936560970	5 PK 970	99366D1040	6 PK 1045
9936501010	5 PK 1015	9936561140	5 PK 1140	99366D1930	6 PK 1930
9936501050	5 PK 1055	9936570820	5 PK 820	99366H1040	6 PK 1045
9936501060	5 PK 1060	9936570840	5 PK 835	99366H1840	6 PK 1840
9936501080	5 PK 1080	9936570880	5 PK 880	99366K0910	6 PK 913
9936501100	5 PK 1104	9936570980	5 PK 970	99366K1040	6 PK 1045
9936501110	5 PK 1110	9936571070	5 PK 1070	99366K1230	6 PK 1230
9936501120	5 PK 1125	9936571090	5 PK 1090	99366K1770	6 PK 1765
9936501290	5 PK 1290	9936571100	5 PK 1104	9936700920	7 PK 920
9936501300	5 PK 1300	9936571110	5 PK 1110	993670092083	7 PK 920
9936502295	5 PK 1000	9936571120	5 PK 1125	9936750920	7 PK 920
9936510970	5 PK 970	9936571190	5 PK 1190	99367L1370	7 PK 1370
9936510980	5 PK 975	9936571290	5 PK 1290	99367L1870	7 PK 1870
9936511110	5 PK 1110	9936580820	5 PK 820	9936C1220	6 PK 1215
9936511190	5 PK 1190	9936580840	5 PK 835	9938591110	5 PK 1110
9936520870	4 PK 870	9936580870	4 PK 870	99385C1110	5 PK 1110
9936520880	5 PK 880	9936580890	5 PK 890	99385D1110	5 PK 1110
9936520920	5 PK 920	9936580910	5 PK 905	9952100870	AVX 10 x 875
9936520970	5 PK 970	9936580920	5 PK 920	9952110780	AVX 10 x 775
9936520980	5 PK 970	9936580970	5 PK 970	9952110789	AVX 10 x 785
9936521010	5 PK 1015	9936581030	5 PK 1030	9952110808	AVX 10 x 800
9936521030	5 PK 1030	9936581080	5 PK 1080	9952110839	AVX 10 x 838
9936521050	5 PK 1055	9936581090	5 PK 1090	9952110843	AVX 10 x 838
9936521060	5 PK 1060	9936581100	5 PK 1104	9952110851	AVX 10 x 850
9936521070	5 PK 1070	9936581110	5 PK 1110	9952110853	AVX 10 x 850
9936521080	5 PK 1080	9936581120	5 PK 1125	9952110860	AVX 10 x 864
9936521100	5 PK 1104	9936581130	5 PK 1130	9952110873	AVX 10 x 875
9936521110	5 PK 1110	9936581150	5 PK 1145	9952110880	AVX 10 x 875
9936521130	5 PK 1130	9936581190	5 PK 1190	9952110885	AVX 10 x 888



Teilenummer Part number	Abmessung Dimension
----------------------------	------------------------

Teilenummer Part number	Abmessung Dimension
----------------------------	------------------------

Teilenummer Part number	Abmessung Dimension
----------------------------	------------------------

**TOYOTA**

9952110887	AVX 10 x 888
9952110889	AVX 10 x 888
9952110897	AVX 10 x 900
9952110902	AVX 10 x 900
9952110929	AVX 10 x 925
9952210808	AVX 13 x 825
9952210848	AVX 13 x 850
9952210890	AVX 13 x 900
9952210892	AVX 13 x 900
9952210900	AVX 13 x 900
9952210901	AVX 13 x 900
9952210904	AVX 13 x 900
9952210911	AVX 13 x 925
9952210913	AVX 13 x 925
9952210918	AVX 13 x 925
9952210925	AVX 13 x 925
9952210926	AVX 13 x 925
9952210934	AVX 13 x 950
9952210938	AVX 13 x 950
9952210942	AVX 13 x 950
9952210951	AVX 13 x 950
9952210958	AVX 13 x 950
9952210958	AVX 13 x 960
9952210960	AVX 13 x 975
9952210964	AVX 13 x 975
9952210976	AVX 13 x 975
9952210980	AVX 13 x 975
9952211002	AVX 13 x 1100
9952211159	AVX 13 x 1150
9952211180	AVX 13 x 1175
9952211192	AVX 13 x 1200
9952211218	AVX 13 x 1225
9952211232	AVX 13 x 1225
9952211243	AVX 13 x 1250
9952211256	AVX 13 x 1250
9952211275	AVX 13 x 1250
9952211363	AVX 13 x 1375
9952211390	AVX 13 x 1400
9952211920	AVX 13 x 925
99919225550	AVX 13 x 1200
MN195737	5 PK 905
SU00100085	ZRK 1351
SU00100088	437ST
SU00100089	384UT
SU00100542	332UT
SU00100543	331ST
SU00100544	ZRK 1441
SU00100545	KT 1328
SU00100784	384UT

**TRIUMPH**

13H924	AVX 10 x 938
201403	AVX 10 x 1050
214239	AVX 10 x 1110
214303	AVX 10 x 1025
214314	AVX 10 x 1110
214325	AVX 10 x 1100
217391	AVX 10 x 1100
217607	AVX 10 x 950
ADU6528	AVX 10 x 938
BNP2955	ZRK 1033
BNP2956	ZRK 1033
GCB10937	AVX 10 x 938
GFB123	AVX 13 x 1100 TM
GFB189	AVX 13 x 1075

**TRIUMPH**

GFB272	AVX 10 x 938
GFB60937	AVX 10 x 938
GFB701	AVX 10 x 938
TKC1616	AVX 10 x 1100
TKC2165	AVX 10 x 1100
TKC2444	AVX 13 x 925
TKC2802	AVX 10 x 938
TKC386	AVX 10 x 900
TKC6621	AVX 10 x 1100
TRC2801	AVX 10 x 975

**UAZ**

9681308020	AVX 10 x 938
------------	--------------

**VAG**

058198119A	KT 1356
06C109119	ZRK 1433

**VAUXHALL**

090409610	AVX 10 x 1000
090409800	AVX 10 x 940
090410387	AVX 10 x 960
090411009	AVX 10 x 1025
090412115	AVX 10 x 920
090448698	AVX 10 x 900
09129067	AVX 10 x 925
11282245848	5 PK 1815
1136713010	AVX 13 x 1450
1340275	6 PK 1555
1340279	6 PK 1450
1340510	6 PK 1863
1340527	6 PK 2120
1340600	6 PK 1250
1340601	6 PK 1590
1340603	4 PK 966
1340605	AVX 10 x 1025
1340607	6 PK 1795
1340608	6 PK 1900
1340611	5 PK 1815
1340613	6 PK 1725
1340614	6 PK 1900
1340615	6 PK 2260
1340616	6 PK 1800
1340617	6 PK 1460
1340618	6 PK 1530
1340619	6 PK 894
1340620	6 PK 1725
1340621	6 PK 1725
1340625	6 PK 1900
1340626	6 PK 1800
1340627	6 PK 1800
1340628	5 PK 1355
1340629	5 PK 1230
1340630	5 PK 1355
1340631	5 PK 1230
1340635	5 PK 1210
1340636	5 PK 1680
1340637	5 PK 940
1340639	6 PK 1870
1340640	4 PK 884
1340641	5 PK 1355
1340642	5 PK 1230
1340643	6 PK 1530
1340644	6 PK 894
1340645	6 PK 1460

**VAUXHALL**

1340646	6 PK 1800
1340647	6 PK 1900
1340648	6 PK 1725
1340649	6 PK 2020
1340651	6 PK 1863
1340652	5 PK 1680
1340657	5 PK 1255
1340658	5 PK 1210
1340660	5 PK 1030
1340661	5 PK 880
1340662	6 PK 1590
1340663	6 PK 1900
1340664	6 PK 1800
1340665	6 PK 1870
1340666	6 PK 1863
1340667	5 PK 1030
1340668	5 PK 880
1340669	5 PK 880
1340671	AVX 10 x 900
1340674	5 PK 1030
1340675	5 PK 880
1340677	5 PK 1030
1340678	5 PK 880
1340680	AVX 10 x 950
1340683	6 PK 1600
1340685	AVX 10 x 1275
1340704	AVX 10 x 888
1340714	AVX 10 x 913
1340718	AVX 10 x 965
1340721	5 PK 1015
1340724	5 PK 970
1340725	AVX 13 x 875
1340727	AVX 13 x 925
1340728	6 PK 1460
1340729	AVX 10 x 920
1340730	AVX 10 x 935
1340730	AVX 10 x 938
1340734	AVX 10 x 935
1340734	AVX 10 x 938
1340736	5 PK 985
1340738	AVX 10 x 920
1340739	AVX 10 x 900
1340742	6 PK 1900
1340743	6 PK 1725
1340745	6 PK 1795
1340746	6 PK 1530
1340747	6 PK 894
1606194	KT 1323
1606196	KT 1385
1606198	KT 1384
1606305	KT 1468
1854708	6 PK 2228
1854710	AVX 10 x 800
1854713	6 PK 2270
1854714	6 PK 2260
1854715	4 PK 805
1854716	AVX 13 x 1525
1854722	4 PK 780
1854723	6 PK 2260
1854726	AVX 13 x 1500
1854727	AVX 13 x 1500
1854728	6 PK 2020
1854730	AVX 13 x 1325
1854730	AVX 13 x 1325 TM
1854733	6 PK 2285

Teilenummer Part number	Abmessung Dimension	Teilenummer Part number	Abmessung Dimension	Teilenummer Part number	Abmessung Dimension
<b>VAUXHALL</b>		<b>VAUXHALL</b>		<b>VAUXHALL</b>	
1854734	6 PK 2040	6340605	5 PK 1450	90264022	501UT
1854736	4 PK 805	6340606	5 PK 1545	90280404	ZRK 1011
1855700	6 PK 2055	6340611	6 PK 1920	90280872	AVX 10 x 800
1855750	6 PK 2055	6340613	5 PK 1370	90281312	ZRK 1015
24413292	6 PK 1900	6340615	6 PK 1185	90281901	AVX 10 x 1025
24413293	6 PK 1800	6340617	6 PK 1275	90285678	6 PK 2228
24413294	6 PK 1870	6340618	6 PK 1605	90285679	6 PK 1460
24426500	519ST	6340625	6 PK 1625	90299440	AVX 10 x 913
24435940	5 PK 1030	6340626	5 PK 1210	90299503	5 PK 970
24466972	5 PK 1030	6340627	5 PK 1210	90323501	502ST
4401428	KT 1392	6340656	5 PK 940	90323503	503UT
4401601	ZRK 1195	6340666	6 PK 1370	90324097	508UR
4401649	6 PK 1138	6340671	6 PK 1250	90324699	ZRK 1016
4402116	6 PK 1138	6340673	6 PK 1590	90325578	ZRK 1278
4402599	6 PK 1130	6352976	AVX 10 x 965	90351803	AVX 10 x 913
4403027	ZRK 1312	636355	ZRK 1097	90352379	ZRK 1014
4403471	6 PK 850	636357	ZRK 1111	90352928	AVX 10 x 935
4403472	6 PK 870	636367	ZRK 1011	90352928	AVX 10 x 938
4404042	6 PK 870	636371	ZRK 1014	90353176	510ST
4405275	7 PK 1145	636372	ZRK 1292	90353179	ZRK 1292
4408352	5 PK 1125	636561	ZRK 1292	90354782	ZRK 1292
4408392	ZRK 1475	636566	ZRK 1292	90354783	510ST
4409473	ZRK 1067	636567	ZRK 1011	90354783	ZRK 1016
4416361	7 PK 1105	636568	ZRK 1023	90409781	6 PK 2270
4418674	7 PK 1105	636575	ZRK 1024	90409782	6 PK 1900
4418675	7 PK 1793	636578	ZRK 1097	90409800	AVX 10 x 935
4430217	6 PK 1840	636654	519ST	90409800	AVX 10 x 938
4500033	5 PK 1200	636728	KT 1461	90409900	ZRK 1278
4500034	6 PK 858	6376167	AVX 10 x 938	90410014	ZRK 1278
4500056	6 PK 845	64552245451	4 PK 780	90410223	ZRK 1292
4506085	KT 1392	7180685	AVX 10 x 938	90410224	ZRK 1011
4506086	ZRK 1462	8200059423	6 PK 850	90410225	ZRK 1011
4506181	6 PK 1795	8200059425	6 PK 870	90410316	5 PK 985
4506189	6 PK 1145	8825967	AVX 10 x 965	90410386	AVX 10 x 888
4710920	4 PK 763	8944503950	AVX 13 x 1450	90410387	AVX 10 x 965
4805514	6 PK 2065	8972328750	6 PK 1275	90410700	6 PK 1725
4808188	6 PK 1890	90006259	AVX 10 x 875	90410771	ZRK 1022
55185077	6 PK 1185	90076999	AVX 10 x 1075	90410784	ZRK 1015
55185078	6 PK 1318	90076999	AVX 10 x 1075 TM	90411028	6 PK 1795
55350420	5 PK 1450	90080214	ZRK 1111	90411769	518ST
55350421	5 PK 1545	90088832	AVX 10 x 875	90411770	ZRK 1023
55350580	506UT	90090214	ZRK 1111	90411773	505UT
55351782	ZRK 1330	90091742	AVX 10 x 888	90411774	515ST
55353810	396ST	90108360	ZRK 1014	90411775	ZRK 1025
55567191	519ST	90128821	ZRK 1013	90411777	ZRK 1291
5636343	ZRK 1540	90156794	AVX 10 x 825	90411782	509UT
5636344	ZRK 1466	90169079	AVX 10 x 960	90411787	504UT
5636357	ZRK 1024	90169079	AVX 10 x 965	90412730	506UT
5636358	ZRK 1291	90169080	AVX 10 x 925	90412731	507UT
5636361	ZRK 1024	90169081	AVX 10 x 875	90412745	6 PK 1530
5636362	ZRK 1024	90169083	AVX 10 x 950	90412783	519ST
5636369	ZRK 1330	90169084	AVX 10 x 850	90412885	6 PK 894
5636373	ZRK 1026	90169195	AVX 10 x 925	90444421	6 PK 1530
5636374	ZRK 1023	90180131	500UT	90444422	6 PK 1530
5636376	ZRK 1431	90183426	AVX 10 x 875	90444423	6 PK 1795
5636452	ZRK 1455	90183427	AVX 10 x 888	90448002	6 PK 2260
5636463	ZRK 1540	90183440	AVX 10 x 913	90466255	AVX 10 x 913
5636565	ZRK 1024	90194098	AVX 10 x 763	90466474	525UT
5636566	ZRK 1330	90194995	AVX 10 x 813	90466524	6 PK 1900
6315516	AVX 10 x 935	90215347	AVX 10 x 785	90467131	6 PK 1725
6315516	AVX 10 x 938	90231797	AVX 10 x 1000	90469987	ZRK 1025
6340600	5 PK 1240	90231883	ZRK 1016	90486316	6 PK 894
6340601	5 PK 1240	90233194	5 PK 1015	90499401	510ST
6340602	6 PK 1990	90234902	ZRK 1278	90499525	ZRK 1256
6340603	6 PK 1880	90260872	AVX 10 x 800	90500227	6 PK 1725



Teilenummer Part number	Abmessung Dimension
----------------------------	------------------------

Teilenummer Part number	Abmessung Dimension
----------------------------	------------------------

Teilenummer Part number	Abmessung Dimension
----------------------------	------------------------

**VAUXHALL****VAUXHALL****VAUXHALL**

90500228	6 PK 1900
90500354	6 PK 2260
90500360	ZRK 1022
90501384	6 PK 1460
90501385	6 PK 2260
90501386	6 PK 1725
90502734	6 PK 1900
90502735	6 PK 1800
90509168	219SR
90509315	5 PK 1815
90509751	4 PK 780
90510025	AVX 10 x 913
90510253	6 PK 1800
90510610	6 PK 1530
90510611	6 PK 894
90528200	518ST
90528603	395ST
90528761	6 PK 2020
90529187	525UT
90529188	525UT
90529810	223UT
90529914	6 PK 1870
90530123	519ST
90530124	518ST
90530125	515ST
90530126	395ST
90530286	ZRK 1023
90530599	ZRK 1022
90531677	ZRK 1292
90531678	ZRK 1292
90531680	ZRK 1024
90531681	ZRK 1291
90531966	5 PK 1355
90531967	5 PK 1230
90541338	6 PK 1800
90542746	5 PK 1355
90542747	5 PK 1355
90542748	5 PK 1230
90542749	5 PK 1230
90542860	525UT
90543739	525UT
90543873	219SR
90570371	ZRK 1023
90570525	510ST
90570913	507UT
90571070	6 PK 1900
90571757	4 PK 884
90573797	5 PK 940
90581642	6 PK 1863
90710530	511ST
91001745	AVX 10 x 888
91002681	AVX 10 x 675
91007299	AVX 10 x 888
91010950	AVX 10 x 1375
91032974	AVX 10 x 675
91039703	AVX 10 x 935
91039703	AVX 10 x 938
91056226	AVX 10 x 935
91056226	AVX 10 x 938
9108204	357ST
9109416	298ST
9109430	398ST
9109489	631UT
9109601	ZRK 1195
9109609	602ST

9109649	6 PK 1138
9110116	6 PK 1138
9110599	6 PK 1130
9110631	298ST
9110632	299UT
9110639	631UT
9110690	603UT
9111144	359UT
91112009	ZRK 1034
9111471	6 PK 850
9111472	6 PK 870
9112042	6 PK 870
91126379	5 PK 1355
91126380	5 PK 1230
91126381	6 PK 1530
91126382	6 PK 894
91126384	6 PK 1460
91126385	6 PK 1800
91126386	6 PK 1900
91126387	6 PK 1725
91126388	6 PK 2020
91126402	6 PK 1863
91126403	5 PK 1680
91131979	6 PK 1863
91132010	5 PK 1030
91140570	AVX 10 x 825
91142246	AVX 10 x 875
91150005	6 PK 1725
91151716	6 PK 1800
91153769	8 PK 2188
91158702	ZRK 1067
91159962	5 PK 1125
91159999	ZRK 1475
91160164	346ST
91160164	602ST
9117585	5 PK 1210
9117586	5 PK 1210
9117587	5 PK 1680
9117588	5 PK 1680
9117589	5 PK 940
9117590	5 PK 940
9118367	4 PK 805
9118611	5 PK 1355
9118612	5 PK 1230
9118613	6 PK 1530
9118614	6 PK 894
9118616	6 PK 1460
9118617	6 PK 1800
9118618	6 PK 1900
9118619	6 PK 1725
9118620	6 PK 2020
9118624	6 PK 1863
9118722	5 PK 1680
9118848	219SR
9120501	KT 1461
9121108	7 PK 1145
9128444	524UT
9128516	519ST
9128656	519ST
9128736	509UT
9128739	506UT
9128740	507UT
9128741	504UT
9128952	5 PK 1210
9129060	ZRK 1026

9129460	5 PK 1230
9129465	6 PK 1795
9129468	6 PK 1900
91580003	518ST
9158004	515ST
9160333	5 PK 1200
9160334	6 PK 858
9160356	6 PK 845
9192568	5 PK 1255
9194660	5 PK 1210
9195191	5 PK 1030
9195192	5 PK 880
9196546	6 PK 1863
9196547	6 PK 1863
9198522	6 PK 1145
9201528	ZRK 1462
9201537	398ST
9201540	399UT
9201679	5 PK 1030
9201688	5 PK 880
9201722	5 PK 1030
9201723	5 PK 880
9201850	6 PK 1795
9202478	510ST
92061744	6 PK 2055
92061745	6 PK 2055
92063918	ZRK 1023
92065368	396ST
9240033	418UT
93160237	346ST
93160244	342ST
93172363	5 PK 1240
93172364	5 PK 1240
93172366	5 PK 1240
93172367	5 PK 1240
93172395	6 PK 1990
93172396	6 PK 1990
93172397	6 PK 1880
93172398	6 PK 1880
93177561	5 PK 1370
93177562	5 PK 1370
93178812	ZRK 1466
93178816	371ST
93180218	KT 1207
93180815	ZRK 1455
93181316	5 PK 1210
93181966	371ST
93182238	5 PK 1230
93182264	5 PK 940
93182266	5 PK 1210
93185023	6 PK 1310
93185756	6 PK 2120
93188136	KT 1465
93188137	KT 1465
93188138	KT 1465
93188674	KT 1461
93195485	7 PK 1793
93196419	4 PK 763
94029834	ZRK 1269
94106001	436UT
94108204	AVX 13 x 1325
94108204	AVX 13 x 1325 TM
94149432	516ST
94160656	ZRK 1050
94337004	AVX 13 x 925



Teilenummer Part number	Abmessung Dimension	Teilenummer Part number	Abmessung Dimension	Teilenummer Part number	Abmessung Dimension
<b>VAUXHALL</b>		<b>VOLVO</b>		<b>VOLVO</b>	
94380679	ZRK 1097	185002	AVX 10 x 935	30731862	6 DPK 1825
94382106	4 PK 966	20411420	10 PK 1350 TM	30731937	6 PK 2200
94382107	4 PK 805	20411860	10 PK 1400 TM	30735750	231ST
94382214	521ST	20412534	8 PK 1275 TM	30750739	631UT
94382215	522UT	20412535	8 PK 1365 TM	30750904	231ST
94385561	ZRK 1280	20430363	8 PK 830 TM	30751288	6 PK 1205
94442970	AVX 13 x 1500	20430367	8 PK 975 TM	30751981	331ST
94449307	ZRK 1280	20430368	8 PK 975 TM	30757007	6 PK 1205
94468652	AVX 13 x 875	20430378	8 PK 1435 TM	30757514	5 PK 1125
94482166	AVX 13 x 1450	20430380	8 PK 1715 TM	30758260	KT 1118
949602	8 PK 2188	20430381	10 PK 1070 TM	30758261	KT 1317
950353	AVX 10 x 875	20430382	10 PK 1108 TM	30777352	6 PK 1840
950358	AVX 10 x 875	20430384	10 PK 1145 TM	30777408	KT 1434
950359	AVX 10 x 1075	20440169	10 PK 1350 TM	30777409	KT 1132
950359	AVX 10 x 1075 TM	20708127	8 PK 830 TM	30777417	5 EPK 705
950360	AVX 10 x 875	209287	AVX 13 x 875	30777530	5 PK 850
950365	AVX 10 x 800	209287	AVX 13 x 875 TM	30777531	5 PK 890
950366	AVX 10 x 950	250257	ZRK 1323	30777660	6 PK 1215
950367	AVX 10 x 813	250334	ZRK 1443	30777865	KT 1390
950373	AVX 13 x 1450	268626	AVX 10 x 775	30809320	6 PK 1138
950375	AVX 13 x 1450	271705	ZRK 1188	30819189	6 PK 1642
96440421	6 PK 2065	2717056	ZRK 1188	30819383	ZRK 1146
96628779	6 PK 2404	271713	ZRK 1057	30855992	603UT
96628792	6 PK 1890	271714	ZRK 1019	30855993	602ST
97065986	ZRK 1097	271746	ZRK 1186	30864046	ZRK 1195
97112438	520ST	271747	ZRK 1177	30864050	631UT
97114552	520ST	271834	ZRK 1191	30865077	ZRK 1075
97130560	6 PK 2285	271835	ZRK 1021	30865078	631UT
97130561	6 PK 2040	271856	ZRK 1191	30873480	5 PK 1345
97143724	ZRK 1431	271876	ZRK 1194	30873534	4 PK 780
97186395	6 PK 1250	271952	ZRK 1188	30873950	ZRK 1211
97186396	6 PK 1590	272327	ZRK 1191	30873954	237UT
97229071	6 PK 1590	272328	ZRK 1079	30874031	5 PK 1080
97232826	6 PK 1625	272329	ZRK 1187	30874227	189UT
97232875	6 PK 1275	272386	ZRK 1194	30883810	ZRK 1067
97350979	6 PK 1920	272462	ZRK 1301	30883811	346ST
97714044	AVX 13 x 1450	272472	ZRK 1463	30883832	6 PK 1795
9960524	AVX 10 x 888	274184	ZRK 1463	30889400	632ST
<b>VOLGA</b>		274247	ZRK 1702	30889794	6 PK 1138
7932563795	AVX 10 x 650	274338	ZRK 1187	31104600	ZRK 1463
7932563844	AVX 10 x 888	274557	KT 1434	31216255	6 PK 1642
7932564068	AVX 10 x 1025	274562	ZRK 1172	312162555	6 PK 1642
<b>VOLVO</b>		274602	6 PK 1205	31251046	6 PK 1205
0463633	700ST	298673	AVX 10 x 1225	31251305	6 PK 2215
04636338	700ST	298673	AVX 10 x 1235	31251758	6 PK 975
074130113E	ZRK 1238	30616942	5 PK 1125	31251775	6 PK 800
1091107	8 PK 1435 TM	30621261	603UT	31258305	KT 1474
125086	AVX 10 x 750	30621318	6 PK 1795	31258306	ZRK 1702
1257120	103UT	30621589	KT 1434	31258381	5 PK 1125
12571204	103UT	30623381	5 PK 1125	31259239	331ST
1257223	ZRK 1376	30637495	6 PK 975	31272251	6 PK 1795
1257237	ZRK 1090	30637504	6 PK 800	31272339	6 PK 1795
1271828	6 PK 1610	30638277	246ST	3170949	2-AVX 13 x 1950 TM
1271829	6 PK 1751	30650846	5 EPK 868	3195992	8 PK 1850 TM
1275725	6 PK 1420	30650847	6 EPK 1059	32092876	AVX 13 x 875
1275726	6 PK 1675	30681318	5 PK 1130	32092876	AVX 13 x 875 TM
1326284	703UT	30711066	KT 1390	3210827	AVX 10 x 1235
13262845	703UT	30711068	331ST	3244271	AVX 10 x 864
1336953	701ST	30711069	332UT	3244272	AVX 10 x 935
13369533	701ST	30711607	ZRK 1172	3244272	AVX 10 x 938
1357936	705UT	30731772	ZRK 1702	3287513	ZRK 1101
13579362	705UT	30731808	6 DPK 1841	3287514	4 PK 884
1378122	704ST	30731809	6 DPK 1853	3287776	607UT
		30731811	6 DPK 1825	32877763	607UT
		30731861	6 DPK 1841	3287778	606ST





Teilenummer Part number	Abmessung Dimension
----------------------------	------------------------

Teilenummer Part number	Abmessung Dimension
----------------------------	------------------------

Teilenummer Part number	Abmessung Dimension
----------------------------	------------------------

**VOLVO**

32877789	606ST
3290730	AVX 10 x 1215
329073015	AVX 10 x 1215
3298673	AVX 10 x 1235
3342103	ZRK 1133
3342138	5 PK 850
3342143	601ST
33421439	601ST
3342860	5 PK 886
3343106	4 PK 884
3343720	ZRK 1276
33437203	ZRK 1276
3343740	603UT
3343741	602ST
3343893	ZRK 1147
3411617	6 PK 1153
3416012	6 PK 845
3417142	6 PK 1560
3434934	6 PK 1555
3446588	6 PK 845
3450074	3 PK 600
3454404	3 PK 600
3454405	6 PK 1555
3463763	ZRK 1135
3470280	6 PK 1175
3473195	6 PK 1153
3473196	6 PK 845
3473197	3 PK 600
3473198	6 PK 1555
3474598	3 PK 600
3485927	6 PK 1153
3507227	ZRK 1376
3507651	ZRK 1188
3507652	ZRK 1186
3507704	ZRK 1177
3517995	ZRK 1188
3531279	706UT
35312792	706UT
3531358	ZRK 1019
3547543	704ST
35475433	704ST
3547573	6 PK 1625
3547607	6 PK 1625
3547608	6 PK 1270
3979980	KT 7001
417550	AVX 13 x 1450
417550	AVX 13 x 1450 TM
419407	AVX 10 x 888
419419	AVX 10 x 990
419520	AVX 10 x 888
422602	AVX 13 x 1200
422602	AVX 13 x 1200 TM
460481	AVX 10 x 888
461130	AVX 10 x 875
463377	ZRK 1057
463633	700ST
4636338	700ST
483185	AVX 13 x 1175
483185	AVX 13 x 1175 TM
684121300	AVX 13 x 1325
684121300	AVX 13 x 1325 TM
684121325	AVX 13 x 1325
684121325	AVX 13 x 1325 TM
684121425	AVX 13 x 1425
684121425	AVX 13 x 1425 TM

**VOLVO**

6842469	ZRK 1019
6849008	6 PK 1625
6849009	6 PK 1270
6G9N8620BB	6 PK 1205
70302957	8 PK 1850 TM
70308834	2-AVX 13 x 1450 TM
70312600	8 PK 1327 TM
70326598	10 PK 1860 TM
7400269672	AVX 10 x 1100
7700104652	ZRK 1195
7700107305	ZRK 1075
7700109601	ZRK 1067
7700109632	ZRK 1067
7700718261	4 PK 884
7700865429	6 PK 1138
7700869538	6 PK 1642
795088	AVX 13 x 1150
795088	AVX 13 x 1150 TM
8029802	AVX 13 x 950
8029802	AVX 13 x 950 TM
8149879	KT 7001
8158380	8 PK 1215 TM
8200058139	6 PK 1642
8610041	KT 1118
8627228	6 DPK 1853
8627484	ZRK 1187
8630590	707UT
8631557	ZRK 1702
8642248	632ST
8642251	246ST
8642479	6 PK 1138
8642562	6 PK 1642
8653617	6 PK 2510
8653649	KT 1428
8653650	ZRK 1452
8653651	447ST
8653652	448UT
8670054	ZRK 1702
8670068	6 PK 1215
8670156	6 PK 1305
8670484	246ST
8677053	153ST
8687851	246ST
8692141	6 DPK 1825
8692630	246ST
8692811	5 PK 890
8692955	5 PK 850
8D9478	ZRK 1194
9135031	ZRK 1191
9135032	ZRK 1021
9135036	708ST
91350363	708ST
9135553	ZRK 1194
9135555	709ST
91355550	709ST
9135556	232UT
91355560	232UT
9135733	ZRK 1191
9135933	ZRK 1240
9135946	141UT
91359463	141UT
9146117	6 PK 1250
9146139	714UR
91461392	714UR
9146160	6 PK 1642

**VOLVO**

9146376	707UT
9146377	707UT
91463778	707UT
9146557	6 PK 1625
9146844	6 PK 1250
9146973	6 PK 1270
9179393	ZRK 1238
9180594	234ST
9180701	6 PK 1555
9180702	6 PK 1795
9186258	153ST
9186319	6 PK 1685
9186320	6 PK 1432
9186352	6 PK 1748
9189146	ZRK 1079
9189229	6 PK 1751
9202398	ZRK 1238
9207919	6 PK 1760
9207920	6 PK 1625
9207927	233ST
92079276	233ST
9404713	ZRK 1463
9434341	6 PK 1748
9440329	246ST
9440383	ZRK 1187
9458376	6 DPK 1841
9458411	6 PK 1751
9458469	6 DPK 1825
9464100	ZRK 1301
9464101	153ST
94641016	153ST
9465066	ZRK 1194
9471799	6 DPK 1841
9471981	6 DPK 1841
9479619	AVX 13 x 1225
9479627	AVX 13 x 1275
9493131	AVX 13 x 1325
9497241	6 DPK 1853
950805	AVX 10 x 710
950807	AVX 10 x 888
950809	AVX 10 x 935
950811	AVX 10 x 990
950812	AVX 10 x 1025
950813	AVX 10 x 1050
950814	AVX 10 x 1075
950814	AVX 10 x 1075 TM
950815	AVX 10 x 1100
950819	AVX 10 x 1200
950821	AVX 10 x 1250
950822	AVX 10 x 1275
950823	AVX 10 x 1300
950825	AVX 10 x 1350
950826	AVX 10 x 1375
950832	AVX 10 x 1525
950845	AVX 13 x 1000
950845	AVX 13 x 1000 TM
950848	AVX 13 x 1075
950848	AVX 13 x 1075 TM
950849	AVX 13 x 1100
950849	AVX 13 x 1100 TM
950852	AVX 13 x 1175
950852	AVX 13 x 1175 TM
950853	AVX 13 x 1200
950853	AVX 13 x 1200 TM
950856	AVX 13 x 1275



Teilenummer Part number	Abmessung Dimension	Teilenummer Part number	Abmessung Dimension	Teilenummer Part number	Abmessung Dimension
<b>VOLVO</b>		<b>VOLVO</b>		<b>VOLVO</b>	
950856	AVX 13 x 1275 TM	958347	AVX 10 x 800	958548	AVX 13 x 1325 TM
950857	AVX 13 x 1300	958352	AVX 10 x 925	958549	AVX 13 x 1325 TM
950858	AVX 13 x 1325	958354	AVX 10 x 975	958549	AVX 13 x 1350
950859	AVX 13 x 1350	958358	AVX 10 x 1075	958550	AVX 13 x 1375
950859	AVX 13 x 1350 TM	958358	AVX 10 x 1075 TM	958550	AVX 13 x 1375 TM
950860	AVX 13 x 1375	958359	AVX 10 x 1100	958554	AVX 13 x 1475
950860	AVX 13 x 1375 TM	958360	AVX 10 x 1125	958554	AVX 13 x 1475 TM
950861	AVX 13 x 1400	958361	AVX 10 x 1150	958589	AVX 13 x 1225
950861	AVX 13 x 1400 TM	958363	AVX 10 x 1200	960182	AVX 10 x 888
950866	AVX 13 x 1525	958366	AVX 10 x 1275	960281	AVX 10 x 864
950866	AVX 13 x 1525 TM	958369	AVX 10 x 1350	960282	AVX 10 x 888
9515801	AVX 13 x 1425	958381	AVX 13 x 1650	960283	AVX 10 x 913
9515801	AVX 13 x 1425 TM	958381	AVX 13 x 1650 TM	960284	AVX 10 x 935
9515805	AVX 13 x 1525	958383	AVX 13 x 1700	960284	AVX 10 x 938
9515805	AVX 13 x 1525 TM	958383	AVX 13 x 1700 TM	960285	AVX 10 x 960
951684	AVX 10 x 850	958385	AVX 13 x 1750	960285	AVX 10 x 965
9518400	AVX 13 x 1775	958385	AVX 13 x 1750 TM	960286	AVX 10 x 980
9518400	AVX 13 x 1775 TM	958480	AVX 13 x 750	960287	AVX 10 x 1013
9518588	AVX 13 x 1900	958480	AVX 13 x 750 TM	960289	AVX 10 x 1050
9518588	AVX 13 x 1900 TM	958484	AVX 13 x 850	960293	AVX 10 x 1150
952119	AVX 10 x 710	958487	AVX 13 x 925	960295	AVX 10 x 1215
952138	AVX 10 x 1200	958487	AVX 13 x 925 TM	960296	AVX 10 x 1235
952141	AVX 10 x 1275	958489	AVX 13 x 975	960327	AVX 10 x 913
952144	AVX 10 x 1350	958489	AVX 13 x 975 TM	960459	AVX 13 x 925
9522144	AVX 13 x 1900	958490	AVX 13 x 1000	960459	AVX 13 x 925 TM
9522144	AVX 13 x 1900 TM	958492	AVX 13 x 1050	960468	AVX 10 x 1150
952244	AVX 13 x 925	958492	AVX 13 x 1050 TM	960475	AVX 13 x 1325
952244	AVX 13 x 925 TM	958493	AVX 13 x 1075	960475	AVX 13 x 1325 TM
952248	AVX 13 x 1025	958493	AVX 13 x 1075 TM	960512	AVX 13 x 1125
952248	AVX 13 x 1025 TM	958494	AVX 13 x 1100	960512	AVX 13 x 1125 TM
952249	AVX 13 x 1050	958495	AVX 13 x 1125	960519	AVX 13 x 1300
952249	AVX 13 x 1050 TM	958497	AVX 13 x 1175	960519	AVX 13 x 1300 TM
952254	AVX 13 x 1175	958497	AVX 13 x 1175 TM	9650686080	6 PK 1215
952254	AVX 13 x 1175 TM	958498	AVX 13 x 1200	966381	AVX 10 x 1060
952255	AVX 13 x 1200	958499	AVX 13 x 1225	966382	AVX 10 x 1100
952255	AVX 13 x 1200 TM	958499	AVX 13 x 1225 TM	966383	AVX 10 x 1175
952259	AVX 13 x 1300	958502	AVX 13 x 1300	966384	AVX 10 x 1200
952259	AVX 13 x 1300 TM	958502	AVX 13 x 1300 TM	966385	AVX 10 x 1250
952260	AVX 13 x 1325	958503	AVX 13 x 1325	966387	AVX 13 x 1050
952260	AVX 13 x 1325 TM	958503	AVX 13 x 1325 TM	966387	AVX 13 x 1050 TM
952261	AVX 13 x 1350	958504	AVX 13 x 1350	966388	AVX 13 x 1250
952261	AVX 13 x 1350 TM	958504	AVX 13 x 1350 TM	966388	AVX 13 x 1250 TM
952268	AVX 13 x 1525	958505	AVX 13 x 1375	966389	AVX 13 x 1300
952268	AVX 13 x 1525 TM	958506	AVX 13 x 1400	966389	AVX 13 x 1300 TM
958300	AVX 10 x 750	958506	AVX 13 x 1400 TM	966390	AVX 13 x 1325
958302	AVX 10 x 800	958509	AVX 13 x 1475	966390	AVX 13 x 1325 TM
958305	AVX 10 x 875	958512	AVX 13 x 1550	966391	AVX 13 x 1100
958307	AVX 10 x 925	958525	AVX 13 x 750	966391	AVX 13 x 1100 TM
9583071	AVX 10 x 925	958525	AVX 13 x 750 TM	966392	AVX 13 x 1125
958308	AVX 10 x 950	958539	AVX 13 x 1100	966392	AVX 13 x 1125 TM
958309	AVX 10 x 975	958539	AVX 13 x 1100 TM	966393	AVX 13 x 1200
958312	AVX 10 x 1050	958540	AVX 13 x 1125	966393	AVX 13 x 1200 TM
958313	AVX 10 x 1075	958540	AVX 13 x 1125 TM	966394	AVX 13 x 1200
958313	AVX 10 x 1075 TM	958542	AVX 13 x 1175	966394	AVX 13 x 1200 TM
958314	AVX 10 x 1100	958542	AVX 13 x 1175 TM	966395	AVX 13 x 1225
958315	AVX 10 x 1225	958543	AVX 13 x 1200	966395	AVX 13 x 1225 TM
958316	AVX 10 x 1150	958543	AVX 13 x 1200 TM	966396	AVX 13 x 1275 TM
958317	AVX 10 x 1175	958544	AVX 13 x 1225	966397	AVX 13 x 1325
958318	AVX 10 x 1200	958545	AVX 13 x 1250	966397	AVX 13 x 1325 TM
958320	AVX 10 x 1250	958545	AVX 13 x 1250 TM	966398	AVX 13 x 1325
958324	AVX 10 x 1350	958546	AVX 13 x 1275	966398	AVX 13 x 1325 TM
958325	AVX 10 x 1375	958546	AVX 13 x 1275 TM	9663980	AVX 13 x 1325
958326	AVX 10 x 1400	958547	AVX 13 x 1300	966399	AVX 13 x 1350
958343	AVX 10 x 700	958547	AVX 13 x 1300 TM	966399	AVX 13 x 1350 TM
958345	AVX 10 x 750	958548	AVX 13 x 1325	966605	AVX 13 x 1475



Teilenummer Part number	Abmessung Dimension
----------------------------	------------------------

Teilenummer Part number	Abmessung Dimension
----------------------------	------------------------

Teilenummer Part number	Abmessung Dimension
----------------------------	------------------------

## VOLVO

## VOLVO

## VOLVO

966605	AVX 13 x 1475 TM
966693	AVX 10 x 1050
966694	AVX 10 x 1075
966694	AVX 10 x 1075 TM
966695	AVX 10 x 1125
966696	AVX 10 x 1150
966702	AVX 13 x 1375
966702	AVX 13 x 1375 TM
966845	AVX 13 x 1125
966845	AVX 13 x 1125 TM
966846	AVX 13 x 1150
966846	AVX 13 x 1150 TM
966847	AVX 13 x 1175
966847	AVX 13 x 1175 TM
966858	AVX 13 x 1300
966858	AVX 13 x 1300 TM
966869	AVX 10 x 1150
966894	AVX 10 x 750
966898	AVX 10 x 800
966902	AVX 10 x 850
966904	AVX 10 x 875
966905	AVX 13 x 850
966909	AVX 10 x 938
966909	AVX 10 x 940
966910	AVX 10 x 950
966912	AVX 10 x 975
966913	AVX 10 x 990
966915	AVX 10 x 1013
966923	AVX 10 x 1235
9669236135	AVX 10 x 1250
966931	AVX 10 x 1400
966964	AVX 10 x 913
966965	AVX 10 x 925
966968	AVX 10 x 975
966976	AVX 10 x 1075
966976	AVX 10 x 1075 TM
966978	AVX 10 x 1100
966993	AVX 10 x 1350
9670068	6 PK 1215
967102	AVX 13 x 925
967102	AVX 13 x 925 TM
967103	AVX 13 x 925
967103	AVX 13 x 925 TM
967107	AVX 13 x 975
967107	AVX 13 x 975 TM
967111	AVX 13 x 1025
967111	AVX 13 x 1025 TM
967112	AVX 13 x 1050
967112	AVX 13 x 1050 TM
967113	AVX 13 x 1060
967114	AVX 13 x 1075
967114	AVX 13 x 1075 TM
967122	AVX 13 x 1175
967122	AVX 13 x 1175 TM
967126	AVX 13 x 1225
967126	AVX 13 x 1225 TM
967129	AVX 13 x 1275
967129	AVX 13 x 1275 TM
967133	AVX 13 x 1350
967133	AVX 13 x 1350 TM
967137	AVX 13 x 1400
967137	AVX 13 x 1400 TM
967139	AVX 13 x 1425
967144	AVX 13 x 1075
967144	AVX 13 x 1075 TM

967184	AVX 13 x 1075
967184	AVX 13 x 1075 TM
967191	AVX 13 x 1250
967191	AVX 13 x 1250 TM
967194	AVX 13 x 1325
967194	AVX 13 x 1325 TM
967197	AVX 13 x 1425
967197	AVX 13 x 1425 TM
967199	AVX 13 x 1450
967199	AVX 13 x 1450 TM
967201	AVX 13 x 1500
967201	AVX 13 x 1500 TM
967202	AVX 13 x 1500
967202	AVX 13 x 1500 TM
967204	AVX 13 x 1525
967204	AVX 13 x 1525 TM
967205	AVX 13 x 1550
967205	AVX 13 x 1550 TM
967206	AVX 13 x 1550
967206	AVX 13 x 1550 TM
967207	AVX 13 x 1550
967207	AVX 13 x 1550 TM
968135	AVX 13 x 1425
968296	AVX 10 x 1000
968320	AVX 10 x 1000
968326	AVX 10 x 1175
968424	AVX 10 x 913
968425	AVX 10 x 925
968910	AVX 10 x 1150
968933	AVX 10 x 1075
968933	AVX 10 x 1075 TM
968934	AVX 10 x 1075
968934	AVX 10 x 1075 TM
968935	AVX 10 x 1100
968936	AVX 10 x 1100
969474	AVX 10 x 1275
969991	AVX 13 x 1200
969992	AVX 13 x 1200
973487	AVX 11,9 x 1010
973488	AVX 11,9 x 1000
973489	AVX 13 x 975
973489	AVX 13 x 975 TM
9734898	AVX 13 x 975
9734898	AVX 13 x 975 TM
973490	AVX 13 x 1060 TM
973490	AVX 13 x 1075
973534	AVX 10 x 800
973535	AVX 10 x 850
9735358	AVX 10 x 940
973537	AVX 10 x 925
973538	AVX 10 x 935
973538	AVX 10 x 938
973539	AVX 10 x 950
973540	AVX 10 x 975
973541	AVX 10 x 975
973542	AVX 10 x 990
973543	AVX 10 x 1013
973544	AVX 10 x 1235
973545	AVX 13 x 1425
973547	AVX 10 x 875
973548	AVX 13 x 925
973548	AVX 13 x 925 TM
973982	AVX 10 x 925
976115	AVX 10 x 1250
976411	AVX 10 x 888

976483	AVX 10 x 950
976485	AVX 10 x 1125
976489	AVX 10 x 1175
976490	AVX 10 x 1200
977221	AVX 13 x 1350
977221	AVX 13 x 1350 TM
977260	AVX 10 x 925
977317	AVX 13 x 1250
977317	AVX 13 x 1250 TM
977319	AVX 13 x 1300
977319	AVX 13 x 1300 TM
977320	AVX 13 x 1400
977320	AVX 13 x 1400 TM
977321	AVX 13 x 1425
977321	AVX 13 x 1425 TM
977322	AVX 13 x 1450
977322	AVX 13 x 1450 TM
977323	AVX 13 x 1500
977323	AVX 13 x 1500 TM
977571	AVX 10 x 913
977572	AVX 13 x 1250
977572	AVX 13 x 1250 TM
977573	AVX 13 x 1400
977573	AVX 13 x 1400 TM
977731	AVX 10 x 950
977731	AVX 13 x 950 TM
977822	8 PK 1005 TM
977825	8 PK 1020 TM
977828	8 PK 1035 TM
977828	KT 7001
977832	8 PK 1055 TM
977836	8 PK 1075 TM
977840	8 PK 1095 TM
978207	8 PK 800 TM
978213	8 PK 830 TM
978214	8 PK 830 TM
978227	8 PK 900 TM
978228	8 PK 900 TM
978229	8 PK 900 TM
978238	8 PK 955 TM
978242	8 PK 975 TM
978243	8 PK 975 TM
978273	AVX 10 x 1175
978367	AVX 10 x 1200
978383	AVX 13 x 900
978383	AVX 13 x 900 TM
978397	AVX 13 x 1175
978704	AVX 13 x 1050
978704	AVX 13 x 1050 TM
978740	AVX 13 x 1150
978740	AVX 13 x 1150 TM
978751	AVX 13 x 1200
978751	AVX 13 x 1200 TM
978756	AVX 13 x 1225
978756	AVX 13 x 1225 TM
978787	AVX 13 x 1375
978828	AVX 13 x 1575
978828	AVX 13 x 1575 TM
978829	AVX 13 x 1575
978829	AVX 13 x 1575 TM
979631	AVX 13 x 975
979631	AVX 13 x 975 TM
979956	8 PK 1230 TM
980481	8 PK 1560 TM
980886	8 PK 1435 TM





Teilenummer Part number	Abmessung Dimension	Teilenummer Part number	Abmessung Dimension	Teilenummer Part number	Abmessung Dimension
<b>VOLVO</b>		<b>VW</b>		<b>VW</b>	
981331	10 PK 1070 TM	026109243C	175UT	028903137AS	6 PK 1055
981335	10 PK 1108 TM	026109243E	100UT	028903137B	6 PK 1045
981337	10 PK 1136 TM	026109243E	175UT	028903137BB	6 PK 1045
981338	10 PK 1145 TM	026109243F	100UT	028903137E	AVX 10 x 980
981387	10 PK 1950 TM	026109243F	175UT	028903137G	6 PK 925
981388	10 PK 2063 TM	026109243G	175UT	028903137T	6 PK 1045
981390	10 PK 1690 TM	026109243L	100UT	029018381B	AVX 13 x 950
981680	AVX 11,9 x 1000	026109243L	175UT	030109119A	ZRK 1012
981723	8 PK 1715 TM	026142571	AVX 10 x 725	030109119AB	ZRK 1288
982570	8 PK 1560 TM	026145271	AVX 10 x 730	030109119B	ZRK 1012
MD304887	5 PK 1345	026198119	KT 1135	030109119E	ZRK 1012
MD343575	4 PK 780	026903137C	AVX 10 x 950	030109119F	ZRK 1321
MD345384	5 PK 1080	027109119A	ZRK 1232	030109119G	ZRK 1288
<b>VW</b>		027109119B	ZRK 1232	030109119H	ZRK 1288
00A260849	6 PK 2205	027109119C	ZRK 1232	030109119M	ZRK 1288
00A903137	6 PK 2100	027109243	102ST	030109119S	ZRK 1288
021012060A	463UT	027198119	KT 1382	030109243C	124ST
021131615	AVX 10 x 710	027903137	AVX 10 x 630	030109243D	125ST
021131615A	AVX 10 x 710	027903137A	AVX 10 x 864	030109243F	125ST
021145933	7 DPK 1360	028109119AA	ZRK 1304	030109243J	125ST
021145933A	7 PK 1290	028109119AC	ZRK 1339	030109243K	125ST
021145933B	7 PK 1290	028109119D	ZRK 1290	030109243L	222ST
021145933C	7 PK 1290	028109119G	ZRK 1290	030109243M	222ST
021145933D	7 DPK 1360	028109119H	ZRK 1290	030145933	6 PK 1100
021145933G	7 PK 1290	028109119J	ZRK 1290	030145933AB	6 PK 760
021145933H	7 DPK 1360	028109119K	ZRK 1290	030145933AC	6 PK 1700
021145933K	7 DPK 1400	028109119M	ZRK 1290	030145933AQ	6 PK 1700
021145933P	7 DPK 1360	028109119N	ZRK 1339	030145933E	6 PK 1070
021903109A	AVX 10 x 965	028109119P	ZRK 1290	030145933G	6 PK 1070
021903137A	AVX 10 x 965	028109119S	ZRK 1304	030145933K	6 PK 1078
022145933AG	6 PK 1610	028109243D	121ST	030145933L	6 PK 1070
022145933AP	6 PK 1610	028109243E	128ST	030145933R	6 PK 1070
022145933F	7 PK 1280	028109243F	128ST	030145933T	6 PK 1070
022145933G	6 DPK 1320	028109243G	121ST	030198119A	KT 1034
022145933H	6 PK 1265	028109243H	238ST	030198119B	KT 1285
022145933N	6 PK 1240	028109243J	238ST	030903137AB	6 PK 750
022145933T	6 PK 1625	028109243K	238ST	030903137E	AVX 11,9 x 710
023109243	422ST	028109244	111UT	030903137K	6 PK 737
023145271	AVX 10 x 864	028145271E	AVX 11,5 x 685	030903137T	6 PK 750
023145271A	AVX 10 x 864	028145271F	AVX 11,5 x 755	031109119C	ZRK 1116
023260849	AVX 13 x 1325	028145271G	AVX 11,5 x 730	031109119D	ZRK 1116
023260849A	AVX 13 x 1325	028145271H	AVX 11,5 x 790	031130113C	ZRK 1265
023903137A	AVX 10 x 1075	028145271K	AVX 10 x 730	032109119	ZRK 1215
023903137A	AVX 10 x 1075 TM	028145271M	AVX 11,5 x 790	032109119F	ZRK 1289
023903137B	AVX 10 x 1075	028145278A	114SR	032109119G	ZRK 1289
023903137B	AVX 10 x 1075 TM	028145278E	114SR	032109119J	ZRK 1289
023903137B	AVX 10 x 1075 TM	028145278J	143UR	032145933	6 PK 1185
023903137C	AVX 10 x 1140	028198119	KT 1004	032145933AA	6 PK 1550
023903137D	AVX 10 x 1140	028198119A	KT 1021	032145933AB	6 PK 1540
023903137E	AVX 13 x 1275	028198119B	KT 1014	032145933E	6 PK 1125
023903137F	AVX 13 x 1275	028198119C	KT 1358	032145933G	6 PK 1125
025260849B	AVX 13 x 1150	028198119D	KT 1308	032145933Q	6 PK 1125
025903137	AVX 10 x 1075	028198119E	KT 1087	032145933R	6 PK 1550
025903137	AVX 10 x 1075 TM	028198119G	KT 1326	032145933S	6 PK 1125
025903137A	AVX 10 x 1100	028260849D	6 PK 1145	032145933T	6 PK 1185
025903137E	AVX 10 x 1100	028260849L	6 PK 1145	032198119	KT 1032
025903137F	AVX 10 x 1100	028260849N	6 PK 1145	034109119	ZRK 1055
025903137G	AVX 10 x 1100	028903137	AVX 10 x 925	034260849	AVX 13 x 910
026109119B	ZRK 1237	028903137AA	6 PK 925	034903137	AVX 10 x 825
026109119D	ZRK 1237	028903137AD	6 PK 925	035109119	ZRK 1049
026109243	100UT	028903137AJ	5 PK 1590	035145271C	AVX 13 x 1025
026109243	175UT	028903137AL	5 PK 1219	035145271E	AVX 13 x 1015
026109243A	100UT	028903137AM	6 PK 925	035145271F	AVX 13 x 1000
026109243A	175UT	028903137AP	5 PK 1219	035260849C	AVX 13 x 992
026109243C	100UT	028903137AR	5 PK 1590	035903137A	AVX 10 x 800



Teilenummer Part number	Abmessung Dimension	Teilenummer Part number	Abmessung Dimension	Teilenummer Part number	Abmessung Dimension
<b>VW</b>		<b>VW</b>		<b>VW</b>	
035903137B	AVX 10 x 800	037903137C	6 PK 975	03G903137H	6 PK 820
035903137C	AVX 10 x 785	037903137D	6 PK 894	03L109119	ZRK 1544
035903137D	AVX 10 x 800	037903137E	6 PK 894	03L109119A	ZRK 1544
035903137E	AVX 10 x 800	037903137F	6 PK 975	03L109119B	ZRK 1572
036109119	ZRK 1222	037903137G	6 PK 975	03L109119C	ZRK 1572
036109119A	ZRK 1219	037903137H	6 PK 1035	03L109119D	ZRK 1544
036109119AC	ZRK 1001	038109119	ZRK 1305	03L109119E	ZRK 1572
036109119AG	ZRK 1001	038109119D	ZRK 1305	03L109119F	ZRK 1544
036109119B	ZRK 1001	038109119L	ZRK 1338	03L109119G	ZRK 1572
036109119C	ZRK 1001	038109119M	ZRK 1423	03L109119J	ZRK 1572
036109119D	ZRK 1219	038109119N	ZRK 1338	03L109243A	466ST
036109119H	ZRK 1219	038109119P	ZRK 1338	03L109244C	160UT
036109119M	ZRK 1001	038109119S	ZRK 1338	03L109244D	119UT
036109119P	ZRK 1001	038109243	155ST	03L198119	KT 1420
036109119Q	ZRK 1001	038109243D	155ST	03L903137	6 PK 1070
036109181A	147ST	038109243F	155ST	03L903137B	6 EPK 842
036109181B	147ST	038109243G	155ST	03L903137D	6 PK 1078
036109243AB	146ST	038109243H	155ST	03L903137H	6 PK 1555
036109243AD	146ST	038109243M	162ST	03L998037	6 EPK 842
036109243AF	146ST	038109243N	155ST	041903137A	AVX 10 x 950
036109243AG	148ST	038109244B	132UT	044109119D	ZRK 1315
036109243E	146ST	038109244C	132UT	044145271	AVX 10 x 650
036109243F	385ST	038109244E	150UT	044145271K	AVX 10 x 650
036109243L	146ST	038109244H	132UT	044260849B	6 PK 1590
036109243R	146ST	038109244J	163UT	044903137	AVX 10 x 965
036109244C	145UT	038109244M	132UT	044903137AE	6 PK 1060
036109244D	145UT	038109244N	163UT	044903137G	6 PK 1555
036109244J	145UT	038109244Q	150UT	044903137H	6 PK 1460
036145933AD	6 PK 1145	038145276	140UR	044903137L	AVX 10 x 965
036145933AG	6 PK 737	038198119	KT 1238	044903137R	6 PK 1870
036145933AJ	6 PK 1078	038198119A	KT 1237	045109119D	ZRK 1439
036145933AL	6 PK 870	038198119B	KT 1248	045109119E	ZRK 1439
036145933AR	6 PK 1375	038198119C	KT 1237	045109119L	ZRK 1439
036145933AS	6 PK 1795	038198119D	KT 1322	045109243A	152ST
036145933AT	6 PK 1078	038198119E	KT 1322	045109243B	159ST
036145933B	6 PK 1125	038198119F	KT 1226	045109243C	152ST
036145933D	6 PK 1125	038903137AA	6 PK 1185	045109243D	159ST
036145933F	6 PK 1090	038903137E	6 PK 1660	045109243F	162ST
036145933G	6 PK 1125	038903137G	6 PK 906	045109244A	160UT
036145933H	6 PK 1550	038903137H	5 PK 1435	045109479B	161ST
036145933J	6 PK 1078	038903137J	6 PK 1660	045109479C	151ST
036145933M	6 PK 745	038903137L	6 PK 1185	045109479D	344ST
036145933Q	6 PK 1125	038903137M	6 PK 780	045260849	6 DPK 1188
036198119	KT 1374	038903137N	6 PK 1100	045903137D	6 PK 995
036198119B	KT 1374	038903137R	6 PK 1138	045903137E	6 PK 858
036198119C	KT 1445	038903137S	6 DPK 1215	046109119	ZRK 1301
036198119E	KT 1209	038903137T	5 PK 1435	046109119E	ZRK 1301
036198119F	KT 1374	03C145933A	5 PK 491	046145271	AVX 10 x 800
037109119B	ZRK 1056	03C260849A	6 PK 1700	046198113	ZRK 1257
037109119C	ZRK 1315	03C903137A	6 PK 1600	046260849A	AVX 13 x 900
037145271	AVX 10 x 660	03D145933	6 PK 1450	046903137	AVX 10 x 900
037145271E	AVX 11,5 x 685	03D145933AD	6 PK 1880	047260849	AVX 13 x 900
037145271F	AVX 11,5 x 755	03D145933AG	6 PK 1450	047903137E	6 PK 1880
037145276	116UR	03D145933S	6 PK 1460	047903137G	6 PK 1520
037145276A	116UR	03E260849A	6 PK 1870	048109119B	ZRK 1315
037145933	6 PK 1655	03F260849A	6 PK 1690	048109119C	ZRK 1222
037145933A	6 PK 1751	03F903137A	6 PK 1432	048109119D	ZRK 1315
037145933B	6 PK 1655	03G109119	ZRK 1468	048109119E	ZRK 1315
037145933C	6 PK 1751	03G109119B	ZRK 1468	048109119F	ZRK 1315
037198119	KT 1258	03G109243	423ST	048109119G	ZRK 1222
037260849	6 PK 1153	03G109244	424UT	048131121	AVX 10 x 775
037260849A	6 PK 1145	03G198119	KT 1403	048198119	KT 1381
037260849B	6 PK 1145	03G903137A	6 PK 950	048260849	AVX 13 x 900
037260849C	6 PK 1153	03G903137B	6 PK 1055	048903137	AVX 10 x 900
037903137B	6 PK 894	03G903137F	6 PK 1610	049145271	AVX 10 x 875

Teilenummer Part number	Abmessung Dimension	Teilenummer Part number	Abmessung Dimension	Teilenummer Part number	Abmessung Dimension
<b>VW</b>		<b>VW</b>		<b>VW</b>	
049260849A	AVX 13 x 825	058903133D	134SR	068121039H	AVX 10 x 617
049903137	AVX 10 x 950	058903137E	5 PK 1300	068121039K	AVX 10 x 635
049903137A	AVX 10 x 938	059 198 119 A/	KT 1460	068121039L	AVX 10 x 838
049903137A	AVX 10 x 950	059109119A	ZRK 1464	068121039M	AVX 10 x 900
049903137B	AVX 10 x 950	059109119B	ZRK 1464	068145271	AVX 10 x 740
049903137C	AVX 10 x 950	059109119C	ZRK 1224	068145271A	AVX 10 x 740
049903137D	AVX 10 x 938	059109119D	ZRK 1581	068145271B	AVX 10 x 740
049903137D	AVX 10 x 940	059109119F	ZRK 1731	068145271C	AVX 10 x 763
049903137E	AVX 10 x 950	059109243D	244UT	068145271E	AVX 11,9 x 650
050260849	AVX 13 x 800	059109243F	297ST	068260149A	AVX 13 x 825
051109243	102ST	059109243G	297ST	068260849	AVX 13 x 950
051109243A	393ST	059109243J	244UT	068260849A	AVX 13 x 950
051198119	KT 1288	059109243L	297ST	068260849AE	AVX 13 x 1225
052109119	ZRK 1043	059109244	415UT	068260849B	AVX 13 x 950
052109119A	ZRK 1043	059109244A	415UT	068260849C	AVX 13 x 1000
052900333	AVX 10 x 685	059109244B	415UT	068260849D	AVX 13 x 1250
052903137	AVX 10 x 690	059109479B	247ST	068260849E	AVX 13 x 1225
052903137	AVX 10 x 695	059109487A	248ST	068260849G	AVX 13 x 950
052903137	AVX 10 x 700	059109487B	248ST	068260849J	AVX 13 x 865
052903137A	AVX 10 x 695	059109487C	248ST	068903137	AVX 10 x 730
052903137B	AVX 10 x 685	059119137A	AVX 10 x 1025	068903137A	AVX 10 x 875
052903137C	AVX 10 x 695	059130113	ZRK 1331	068903137AA	AVX 10 x 965
052903137D	AVX 10 x 695	059130113A	ZRK 1331	068903137AC	AVX 10 x 763
052903137E	AVX 10 x 695	059130113B	ZRK 1331	068903137AD	AVX 10 x 763
052903137F	AVX 10 x 675	059198119A	KT 1246	068903137AE	AVX 13 x 1225
052903137G	AVX 10 x 685	059198119A	KT 1441	068903137AF	AVX 10 x 600
052903137H	AVX 10 x 675	059198119A	KT 1444	068903137AG	AVX 10 x 695
052903137L	AVX 10 x 685	059198119B	KT 1246	068903137AL	AVX 10 x 735
052903137M	AVX 10 x 675	059198119B	KT 1441	068903137AM	AVX 10 x 710
054903137	AVX 10 x 864	059198119B	KT 1444	068903137AQ	AVX 10 x 695
055131615	AVX 10 x 725	059260849B	4 PK 1237	068903137AR	AVX 11,9 x 950
055131615A	AVX 10 x 825	059903137	AVX 10 x 875	068903137AS	AVX 10 x 965
055131615B	AVX 10 x 763	059903137AC	6 PK 2475	068903137AT	AVX 11,9 x 965
055260849	AVX 13 x 1125	059903137B	AVX 10 x 875	068903137B	AVX 10 x 875
055260849A	AVX 10 x 1125	059903137H	6 PK 2404	068903137C	AVX 10 x 600
055260849B	AVX 13 x 1050	059903137T	6 PK 2490	068903137D	AVX 10 x 965
055260849C	AVX 13 x 1025	060145271	AVX 10 x 800	068903137D	AVX 11,9 x 950
055260849E	AVX 13 x 1025	060145271A	AVX 10 x 800	068903137F	AVX 10 x 735
055260849E	AVX 13 x 1030	060419879	AVX 13 x 750	068903137G	AVX 10 x 625
055903137A	AVX 10 x 950	060903137	AVX 10 x 1013	068903137J	AVX 10 x 775
055903137B	AVX 10 x 1150	061419879	AVX 13 x 775	068903137L	AVX 10 x 875
055903137C	AVX 10 x 850	061903137	AVX 10 x 1140	068903137M	AVX 10 x 875
055903137G	AVX 10 x 850	062145278	400SR	068903137Q	AVX 10 x 730
055903137H	AVX 10 x 700	062145933	6 PK 1642	068903137Q	AVX 10 x 735
056109119A	ZRK 1056	062145933A	6 PK 1685	068903137R	AVX 10 x 735
056198119	KT 1001	062260849	6 PK 2130	068903137S	AVX 10 x 775
056198119	KT 1288	062260849B	6 PK 2155	068903137T	AVX 10 x 960
056903137	AVX 10 x 950	062903137	6 PK 2000	068903137T	AVX 10 x 965
058109119A	ZRK 1223	063903137	AVX 13 x 900	069109119A	ZRK 1376
058109119B	ZRK 1224	066145933J	6 DPK 1320	069109243B	103UT
058109119C	ZRK 1224	066145933K	6 PK 1265	069130113A	ZRK 1090
058109119D	ZRK 1223	068109119	ZRK 1242	069145107	AVX 10 x 600
058109243C	142ST	068109119A	ZRK 1242	069145271	AVX 13 x 1050
058109243E	142ST	068109119E	ZRK 1242	069903137	AVX 10 x 800
058109244	119UT	068109119F	ZRK 1242	069903137A	AVX 10 x 800
058109479B	141ST	068109243	101ST	069903137AC	AVX 10 x 763
058131121	AVX 10 x 650	068109243C	101ST	069903137B	AVX 10 x 813
058198119	KT 1206	068109243F	101ST	069903137C	AVX 11,5 x 790
058198479	KT 1205	068121039	AVX 10 x 600	06A109119A	KT 1301
058260511	133SR	068121039A	AVX 10 x 685	06A109119B	ZRK 1216
058260849	4 PK 855	068121039B	AVX 10 x 650	06A109119C	ZRK 1216
058260849A	4 PK 855	068121039C	AVX 10 x 617	06A109119D	ZRK 1216
058903133	134SR	068121039E	AVX 10 x 685	06A109119J	ZRK 1216
058903133B	134SR	068121039F	AVX 10 x 913	06A109119K	ZRK 1216
058903133C	134SR	068121039G	AVX 10 x 617	06A109479	120ST



Teilenummer Part number	Abmessung Dimension	Teilenummer Part number	Abmessung Dimension	Teilenummer Part number	Abmessung Dimension
<b>VW</b>		<b>VW</b>		<b>VW</b>	
06A109479A	120ST	074109119B	ZRK 1301	074260849AC	6 PK 2228
06A109479B	120ST	074109119E	ZRK 1301	074260849AD	6 PK 2215
06A109479C	120ST	074109119F	ZRK 1241	074260849AE	6 PK 2215
06A145933D	6 PK 1125	074109119H	ZRK 1241	074260849J	6 PK 2130
06A145933L	6 PK 925	074109119J	ZRK 1301	074260849L	6 PK 2240
06A198119	KT 1133	074109119L	ZRK 1301	074260849S	6 PK 2170
06A198119B	KT 1230	074109119P	ZRK 1301	074260849T	6 PK 2228
06A260849B	6 DPK 1195	074109119R	ZRK 1301	074903137	AVX 10 x 838
06A260849C	6 DPK 1195	074109137AC	AVX 10 x 1150	074903137AA	6 PK 2000
06A260849E	6 DPK 1195	074109243C	236ST	074903137AB	AVX 10 x 1085
06A260849K	6 PK 1035	074109243E	153ST	074903137AC	AVX 10 x 1150
06A903315D	135SR	074109243F	149ST	074903137AF	AVX 10 x 1150
06A903315E	135SR	074109243G	149ST	074903137AH	AVX 13 x 1125
06A903315F	135SR	074109243H	236ST	074903137AM	6 PK 1765
06B109119A	ZRK 1220	074109243J	149ST	074903137AN	AVX 13 x 1125
06B109119B	ZRK 1220	074109243M	153ST	074903137AP	6 PK 2075
06B109119F	ZRK 1220	074109243R	149ST	074903137AR	6 PK 2100
06B109119L	ZRK 1220	074130113	ZRK 1270	074903137AS	6 PK 2075
06B109243	230ST	074130113E	ZRK 1238	074903137AT	6 PK 2065
06B109243A	127ST	074130113J	ZRK 1238	074903137BA	6 PK 2080
06B109243B	157ST	074130195	233ST	074903137BB	6 PK 2065
06B109243D	127ST	074130195B	233ST	074903137BC	6 PK 2115
06B109243E	157ST	074130245	234ST	074903137L	AVX 13 x 1275
06B109243F	127ST	074145271J	AVX 10 x 864	074903138	AVX 13 x 1175
06B109244	156UT	074145278E	116UR	075109119B	ZRK 1376
06B109477	136ST	074145933AD	6 PK 1751	075109119C	ZRK 1240
06B109477A	158ST	074145933AJ	6 PK 1695	075109243B	141UT
06B109479	136ST	074145933AK	6 PK 1765	075109243D	141UT
06B198119	KT 1230	074145933AL	6 PK 1352	075145271	AVX 13 x 800
06B198119A	KT 1232	074145933AR	6 PK 1751	075145271C	AVX 13 x 800
06B260849A	4 PK 855	074145933C	6 PK 1718	075260849	AVX 13 x 865
06B903137	5 PK 1300	074145933G	6 PK 2065	075903137	AVX 10 x 800
06B903137E	5 PK 1300	074145933N	6 PK 1345	076109119A	ZRK 1539
06C109119C	ZRK 1433	074145933P	6 PK 1718	076145107	AVX 10 x 1025
06D109119	ZRK 1313	074145933Q	6 PK 1352	076145933	6 PK 2000
06D109119B	ZRK 1443	074145933T	6 PK 2145	076260849	6 PK 2585
06D109119D	ZRK 1443	074198119	KT 1214	076260849A	4 EPK 970
06D109243	387ST	074198119	KT 1302	076260849B	6 PK 2585
06D109243B	442ST	074198119	KT 1442	076903137	AVX 10 x 813
06D109244A	386UT	074198119A	KT 1214	077109244C	349UT
06D109244B	386UT	074198119A	ZRK 1270	077109244E	383UT
06D109244C	443UT	074198119AQ	KT 1442	077109479D	348ST
06D109244D	443UT	074198119B	KT 1218	077109485E	347ST
06D109244E	443UT	074198119B	KT 1302	078109119D	ZRK 1279
06F198119	KT 1375	074198119B	KT 1515	078109243Q	137UT
06F198119A	KT 1432	074198119C	KT 1306	078109243R	137UT
06F260849E	6 PK 1045	074198119D	KT 1402	078109243S	137UT
06F260849L	6 PK 1055	074198119F	KT 1214	078109244H	138UT
06F903137E	6 PK 900	074198119F	ZRK 1270	078109244J	138UT
06F903137L	6 PK 955	074198119G	KT 1218	078109479E	139ST
06H121605E	ZRK 1585	074198119G	KT 1302	078109487A	235UT
06J260849D	6 PK 1115	074198119G	KT 1515	078109487C	235UT
070903137	AVX 10 x 1175	074198119H	KT 1214	078198119A	KT 1261
070903137A	AVX 10 x 695	074198119H	KT 1302	078198479	KT 1304
071145933D	6 PK 1660	074198119H	KT 1214	078903137AP	6 PK 1760
071145933F	6 PK 1285	074198119J	ZRK 1270	078903137BC	6 PK 1880
071145933H	6 PK 2373	074198119N	KT 1214	079903137AA	5 PK 1110
071145933L	6 DPK 1360	074198119N	ZRK 1270	07K145933C	5 PK 925
071145933M	6 PK 2373	074198119P	KT 1218	07K145933E	5 PK 1060
071145933N	6 DPK 1352	074198119P	KT 1302	07K145933G	5 PK 935
071145933P	6 DPK 1352	074198119P	KT 1515	111903137	AVX 13 x 900
073109119	ZRK 1048	074198119Q	KT 1214	111903137B	AVX 10 x 900
073109119A	ZRK 1212	074198119Q	KT 1302	111903137C	AVX 10 x 900
074109119	ZRK 1217	074260849	AVX 13 x 1325	111903137D	9,5 x 905 XDA
074109119A	ZRK 1301	074260849AB	6 PK 2240	111903137E	AVX 10 x 900



Teilenummer Part number	Abmessung Dimension	Teilenummer Part number	Abmessung Dimension	Teilenummer Part number	Abmessung Dimension
<b>VW</b>					
111903137E	AVX 11,3 x 912	4153753	AVX 10 x 913		
113260849A	AVX 10 x 1060	4176840	ZRK 1051		
175903137D	AVX 10 x 825				
1H0119137	2 PJ 800				
1H0119137A	2 PJ 860				
1K0260849A	6 PK 1100				
1K0260849B	6 PK 1100				
1L0198001	KT 1381				
1L0198002	KT 1014				
1L0198002A	KT 1021				
21903137A	AVX 10 x 960				
255272916	AVX 13 x 1150				
2D0145933A	6 PK 2115				
2D0260849	6 PK 2215				
2X0109119A	ZRK 1423				
311903137	AVX 10 x 1050				
311903137A	AVX 10 x 1000				
311903137D	AVX 10 x 900				
311903137E	AVX 10 x 1050				
320260849	AVX 13 x 825				
357119137	2 PJ 786				
357119137E	2 PJ 800				
357119137F	2 PJ 860				
357119137G	2 PJ 786				
3A0119137B	2 PJ 905				
3A0119137C	2 PJ 845				
5X0145271	6 PK 1740				
6K0198001A	KT 1034				
6K0198001B	KT 1288				
6K0198001D	KT 1032				
6K0198002	KT 1001				
6K0198004	KT 1258				
6K0198005	KT 1004				
6Q0260849	6 PK 1735				
6Q0260849A	6 PK 1735				
6Q0260849C	6 PK 1735				
6Q0903137A	6 PK 1090				
701119137A	2 PJ 896				
701119137B	2 PJ 896				
9202398	ZRK 1238				
J1350354021	832ST				
J1350354030	833UT				
J1356854070	ZRK 1134				
J9091602209	AVX 13 x 1050				
J9933200830	AVX 13 x 825				
J9933201040	AVX 13 x 1050				
J9933210870	AVX 13 x 875				
J9936450830	4 PK 835				
J9936450840	4 PK 835				
O49903137B	AVX 10 x 950				
<b>VW (FAW)</b>					
06A109119E	ZRK 1216				
<b>VW (SVW)</b>					
06B109119M	ZRK 1220				
<b>VW-PORSCHE</b>					
021903137A	AVX 10 x 965				
<b>WARTBURG</b>					
108ZA19/1	AVX 10 x 700				
<b>ZASTAVA</b>					
4153752	AVX 10 x 950				

optibelt TruckPOWER KIT	optibelt TRUCK POWER RBK	optibelt SUR
KT 7001	8 PK 1035 TM	 1000 SN
KT 7003	12 PK 1815 TM	 1002 SN
KT 7004	9 PK 2835 TM	 1003 SN
KT 7005	8 PK 1376 TM	 1005 SN
KT 7006	8 PK 880 TM	 1006 SN
KT 7007	8 PK 1509 TM	 1007 SN
KT 7008	9 PK 1888 TM	         1017 SN



**D**
**GB**

<b>Abkürzung</b>	<b>Abkürzungserklärung</b>	<b>Abbreviations</b>
-	OHNE	WITHOUT
+	MIT	WITH
1.	ERSTE	FIRST
2.	ZWEITE	SECOND
AC	KLIMAAANLAGE	AIR CONDITIONER
AC-C	KLIMAKOMPRESSOR	COMPRESSOR AIRCONDITION
ADD	ZUSÄTZLICH	ADDITIONAL
AIR-C	LUFTKOMPRESSOR	AIR COMPRESSOR
AIR-P	LUFTPUMPE	AIR PUMP
ALT	GENERATOR	ALTERNATOR
AMP	AMPERE	AMPERE
AUTO	AUTOMATIKGETRIEBE	AUTOMATIC TRANSMISSION
AUTOMA	AUTOMATISCH	AUTOMATICALLY
AUX-FAN	ZUSATZLÜFTER	AUXILIARY FAN
AWD	ALLRADANTRIEB	ALL WHEEL DRIVE
BAL	AUSGLEICHWELLE	BALANCE SHAFT
CAM	NOCKENWELLE	CAMSHAFT
C-DIM	NETZMASSE	CORE DIMENSIONS
CHA-NO.	FAHRGESTELLSNUMMER	CHASSIS NUMBER
COOL	LADELUFTKÜHLER	INTERCOOLER
CRG	AUFGEADEN	CHARGED
DYN	GLEICHSTROMLICHTMASCHINE	DIRECT-CURRENT GENERATOR
ENG. PTO	MOTORZAPFWELLE	ENGINE PTO SHAFT
EXT COOL	EXTRA KÜHLUNG	EXTR COOLING
EXT HEAT	EXTRA HEIZUNG	EXTRA HEATING
F	FRANKREICH	FRANCE
FAN	LÜFTER	FAN
FROM	VON/AB	FROM
GB	GROSS BRITANNIEN	GREAT BRITAIN
G-PUL	FÜHRUNGSROLLE	GUIDE PULLEY
HYD-P	HYDRAULIKPUMPE	HYDRAULIC PUMP
IDLER	ZWISCHENSCHIEBE	IDLER PULLEY
INJ-P	EINSPRITZPUMPE	INJECTION PUMP
L	LINKS	LEFT
LHD	LINKSLENKUNG	LEFT-HAND DRIVE
MAN-DR	SCHALTGETRIEBE	MANUAL TRANSMISSION
MOD	BAUMUSTER	MODEL
MTR-CODE	MOTORCODE	ENGINE-CODE
MTR-NO.	MOTORNUMMER	ENGINE NUMBER
NL	NIEDERLANDE	NETHERLANDS
NOT	NICHT	NOT
OE-NO.	ERSTAUSRÜSTUNGSNUMMER	ORIGINAL-EXCHANGE-NUMBER
OIL-P	ÖLPUMPE	OIL PUMP
Ø-P	RIEMENSCHIEBEN-Ø	BELT-PULLY-Ø
OPT	WAHLWEISE	OPTIONAL
ORGA-NO.	ORGANISATIONSNUMMER	ORGANISATION NUMBER
PS	SERVOLENKUNG	POWER STEERING PUMP
PTO	NEBENANTRIEB	POWER TAKE-OFF
PUL	RIEMENSCHIEBE	PULLY
QTY.	MENGE	QUANTITY
R	RECHTS	RIGHT
RAD-C	KÜHLKOMPRESSOR	RADIATOR COMPRESSOR
REQ	BENÖTIGT	REQUIRED
RHD	RECHTSLENKUNG	RIGHT-HAND DRIVE
S	SCHWEDEN	SWEDEN
S-PUL	STÜTZSCHIEBE	SUPPORTING PULLEY
STD. COOL	STANDARD KÜHLUNG	STANDARD COOLING
TENS-PUL	SPANNROLLE	TENSIONER PULLEY
TURBO-C	TURBOKOMPRESSOR	TURBOCHARGER COMPRESSOR
UNTIL	BIS	(UP) TO
UP	OBEN	UPPER
VAC-P	VAKUUMPUMPE	VACUUM PUMP
V-PUL	RIPPENRIEMENSCHIEBE	V-RIPPED BELT PULLY
W-P	WASSERPUMPE	WATER PUMP

**F**
**E**
**I**
**NL**

Abkürzung	Explication de l'abréviation	Aclaración a la abreviatura	Spiegazione Abbreviazione	Omschrijving
-	SANS	SIN	SENZA	ZONDER
+	AVEC	CON	CON	MET
1.	PREMIERE	PRIMERO	PRIMO	EERSTE
2.	DEUXIEME	SEGUNDO	SECONDO	TWEEDE
AC	AIR CONDITIONNE	AIRE ACONDICIONADO	CLIMATIZZATORE	AIRCONDITIONING
AC-C	COMPRESSEUR A AIR CONDITIONNE	COMPRESOR AIRE ACONDICIONADO	COMPRESSORE DEL CLIMATIZZATORE	COMPRESSOR AIRCONDITIONING
ADD	SUPPLÉMENTAIRE	ADICIONAL	INOLTRE	EXTRA
AIR-C	COMPRESSEUR D'AIR	COMPRESOR DE AIRE	COMPRESSORE D'ARIA	LUCHTCOMPRESSOR
AIR-P	POMPE A AIR	BOMBA DE AIRE	GONFIATORE	LUCHTPOMP
ALT	ALTERNATEUR	GENERADOR	GENERATORE	GENERATOR
AMP	AMPÈRE	AMPERIO	AMPERE	AMPERE
AUTO	TRANSMISSION AUTOMATIQUE	TRANSMISIÓN AUTOMÁTICA	TRASMISSIONE AUTOMATICA	AUTOMATISCHE TRANSMISSIE
AUTOMA	AUTOMATIQUE	AUTOMÁTICAMENTE	AUTOMATICO	AUTOMATISCH
AUX-FAN	VENTILATEUR SUPPLEMENTAIRE	VENTILADOR ADICIONAL	VENTOLA SUPPLEMENTARE	EXTRA VENTILATOR
AWD	TRACTION INTEGRALE	TRACCIÓN A LAS CUATRO RUEDAS	TRAZIONE INTEGRALE	AANDRIJVING OP ALLE WIELEN
BAL	ONDE DE COMPENSATION	ÁRBOL DE COMPENSACIÓN	ALBERO DI COMPENSAZIONE	BALANCEERAS
CAM	ARBRE A CAMES	ÁRBOL DE DISTRIBUCIÓN	ALBERO A CAMME	NOKKENAS
C-DIM	DIMENSIONS RESEAU	DIMENSIONES CENTRALES	MISURE DI RETE	AFMETINGEN RADIATEUR
CHA-NO.	NUMERO DE CHASSIS	NÚMERO DE CHASIS	NUMERO TELAIO	CHASSISNUMMER
COOL	REFROIDISSEUR AIR D'ALIMENTATION	INTERCOOLER	INTERCOOLER	TUSSENKOELER
CRG	ALIMENTE	CARGADO	CARICO	OPGELADEN
DYN	GENERATRICE A COURANT CONTINU	GENERADOR DE CORRIENTE CONTINUA	GENERATORE A CORRENTE CONTINUA	GELIJKSTROOMGENERATOR
ENG. PTO	PRISE DE FORCE MOTEUR	TOMA DE FUERZA DEL MOTOR	PRESA DI FORZA MOTORE	MOTOR AFTAKAS
EXT COOL	REFROIDISSEMENT SUPPLEMENTAIRE	REFRIGERACIÓN EXTRA	RAFFREDDAMENTO SUPPLEMENTARE	EXTRA KOELING
EXT HEAT	CHAUFFAGE SUPPLEMENTAIRE	CALEFACCIÓN EXTRA	RISCALDAMENTO SUPPLEMENTARE	EXTRA VERWARMING
F	FRANCE	FRANCIA	FRANCIA	FRANKRIJK
FAN	VENTILATEUR	VENTILADOR	VENTILATORE	VENTILATOR
FROM	DE / A PARTIR DE	DE	DA/A PARTIRE DA	VAN
GB	ROYAUME UNI	GRAN BRETAÑA	INGHILTERRA	GROOTBRITANNIË
G-PUL	GUIDE DE POULIE	CILINDRO GUÍA	RULLO GUIDA	GELEIDEBLOK
HYD-P	POMPE HYDRAULIQUE	BOMBA HIDRÁULICA	POMPA IDRAULICA	HYDRAULISCHE POMP
IDLER	RONDELLE INTERMEDIAIRE	DISCO INTERESPACIAL	DISCO INTERMEDIO	TUSSENSCHIJF
INJ-P	POMPE A INJECTION	BOMBA DE INYECCIÓN	POMPA DI INIEZIONE	INJECTIEPOMP
L	LIENS	IZQUIERDA	SINISTRA	LINKS
LHD	COMMANDE A GAUCHE	DIRECCIÓN A LA IZQUIERDA	GUIDA A SINISTRA	STUUR LINKS
MAN-DR	MECANISME DE TRANSMISSION	TRANSMISIÓN MANUAL	TRASMISSIONE	VERSNELLINGSBAK
MOD	MODELE DE CONSTRUCTION	MODELO	PROTOTIPO	MODEL
MTR-CODE	CODE MOTEUR	CÓDIGO DEL MOTOR	CODICE MOTORE	MOTORCODE
MTR-NO.	NUMERO DE MOTEUR	NÚMERO DEL MOTOR	NUMERO MOTORE	MOTORNUMMER
NL	PAYS BAS	PAÍSES BAJOS	OLANDA	NEDERLAND
NOT	NON	NO	NON	NIET
OE-NO.	NUMERO DE PREMIER EQUIPEMENT	NÚMERO DE EQUIPAMIENTO DE SALIDA	NUMERO PRIMA DOTAZIONE	NUMMER ORIGINELE UITRUSTING
OIL-P	POMPE A HUILE	BOMBA DE ACEITE	POMPA DELL'OLIO	OLIEPOMP
Ø-P	POULIES Ø	Ø POLEA	PULEGGE Ø	RIEMSCHIJF-Ø
OPT	EN OPTION	OPCIONAL	A SCELTA	OPTIONEEL
ORGA-NO.	NUMERO D'ORGANISATION	NÚMERO DE ORGANIZACIÓN	NUMERO ORGANIZZAZIONE	ORGANISATIENUMMER
PS	DIRECTION SERVO	DIRECCIÓN ASISTIDA	SERVOSTERZO	STUURBEKRACHTIGING
PTO	COMMANDE AUXILIAIRE	MANDO AUXILIAR	AZIONAMENTO AUSILIARE	KRACHTAFNEEMPUNT
PUL	POULIE	POLEA	PULEGGIA	RIEMSCHIJF
QTY.	QUANTITE	CANTIDAD	QUANTITÀ	AANTAL
R	A DROITE	DERECHA	DESTRA	RECHTS
RAD-C	COMPRESSEUR REFRIGERANT	COMPRESOR DE REFRIGERACIÓN	COMPRESSORE DI RAFFREDDAMENTO	KOELCOMPRESSOR
REQ	REQUIS	REQUERIDO	NECESSARIO	VEREIST
RHD	DIRECTION A DROITE	DIRECCIÓN A LA DERECHA	GUIDA A DESTRA	STUUR RECHTS
S	SUÈDE	SUECIA	SVEZIA	ZWEDEN
S-PUL	DISQUE SUPPORT	DISCO DE APOYO	DISCO DI SOSTEGNO	STEUNSCHIJF
STD. COOL	REFROIDISSEMENT STANDARD	REFRIGERACIÓN ESTÁNDAR	RAFFREDDAMENTO STANDARD	STANDAARDKOELING
TENS-PUL	POULIE TENDEUR	RODILLO TENSOR	RULLO DI SERRAGGIO	SPANROL
TURBO-C	COMPRESSEUR TURBO	TURBOCOMPRESOR	TURBOCOMPRESSORE	TURBOCOMPRESSOR
UNTIL	JUSQU'À	HASTA	FINO A	TOT
UP	AU-DESSUS	ARRIBA	SUPERIORE	BOVEN
VAC-P	POMPE A VIDE	BOMBA DE VACÍO	POMPA PER VUOTO	VACUÛMPOMP
V-PUL	POULIE DENTEE POUR COURROIE	POLEA DENTADA	PULEGGIA PER CINGHIA A SCANALATURE	V-RIEMSCHIJF
W-P	POMPE A EAU	BOMBA DE AGUA	POMPA DELL'ACQUA	WATERPOMP



GR

DK

S

FIN

Abkürzung	ΕΠΕΞΗΓΗΣΗ ΣΥΜΒΟΛΩΝ	Forkortelse oversigt	Förkortningar	Selitys
-	ΑΝΕΥ	UDEN	UTAN	ILMAN (JOTAKIN)
+	ΜΕ	MED	MED	(JONKIN) KANSSA
1.	ΠΡΩΤΗ	FØRSTE	FÖRSTA	ENSIMMÄINEN
2.	ΔΕΥΤΕΡΗ	ANDEN	ANDRA	TOINEN
AC	ΚΛΙΜΑΤΙΣΜΟΣ	KLIMAAANLÆG	KLIMATANLÄGGNING	ILMASTOINTILAITE
AC-C	ΣΑΥΜΠΙΕΣΤΗΣ ΚΛΙΜΑΤΙΣΜΟΥ	KLIMAKOMPRESSOR	KOMPRESSOR	ILMASTOINTIKOMPRESSORI
ADD	ΕΠΙΠΡΟΣΘΕΤΑ	DESUDEN	TILLÄGG	LISÄKSI
AIR-C	ΣΥΜΠΙΕΣΤΗΣ ΑΕΡΟΣ	LUFTKOMPRESSOR	TRYCKLUFTKOMPRESSOR	ILMAKOMPRESSORI
AIR-P	ΑΕΡΟΑΝΤΛΙΑ	LUFTPUMPE	TRYCKLUFTPUMP	ILMAPUMPPU
ALT	ΓΕΝΝΗΤΡΙΑ	GENERATOR	GENERATOR	GENERAATTORI
AMP	ΑΜΠΕΡ	AMPERE	AMPERE	AMPEERI
AUTO	ΑΥΤΟΜΑΤΟ ΚΙΒΩΤΙΟ ΤΑΧΥΤΗΤΩΝ	AUTOMATGEAR	AUTOMATISK VÄXELLÅDA	AUTOMAATTIVAIHTEISTO
AUTOMA	ΑΥΤΟΜΑΤΑ	AUTOMATISK	AUTOMATISK	AUTOMAATTINEN
AUX-FAN	ΕΠΙΠΡΟΣΘΕΤΟΣ ΑΝΕΜΙΣΤΗΡΑΣ	EKSTRAVENTILATOR	EXTRAFLÄKT	LISÄTUULETIN
AWD	ΤΕΤΡΑΚΙΝΟΥΜΕΝΟ	FIRHJULSTRÆK	FYRHJULSDRIFT	NELIPYÖRÄVETO
BAL	ΑΞΩΝΑΣ ΔΙΑΦΟΡΙΚΟΥ	UDLIGNINGSAKSEL	DIFFERENTIALAXEL	TASAPAINOAKSELI
CAM	ΕΚΚΕΝΤΡΟΦΟΡΟΣ ΑΞΩΝΑΣ	KAMAKSEL	KAMAXEL	NOKKA-AKSELI
C-DIM	ΔΙΚΤΥΑΚΟ ΜΕΙΓΜΑ	NETMASSE	NÄTSTOMME	VERKKOMITAT
CHA-NO.	ΑΡΙΘΜΟΣ ΠΛΑΙΣΙΟΥ	CHASSISNUMMER	CHASSINUMMER	RUNKONUMERO
COOL	ΦΟΡΤΟΑΕΡΟΨΥΚΤΗΣ	LADELUFTKØLER	LADDLUFTKYLARE	VÄLILJÄÄHDYTIMIN
CRG	ΦΟΡΤΩΜΕΝΟ	LADET	LADDAD	LATAUTUNUT
DYN	ΓΕΝΝΗΤΡΙΑ ΣΥΝΕΧΟΥΣ ΡΕΥΜΑΤΟΣ	JÆVNSTRØMSGENERATOR	LIKSTRÖMSMOTOR	TASAVIRTALATURI
ENG. PTO	ΑΞΩΝΑΣ ΚΙΝΗΤΗΡΑ	MOTOR-KRAFTUDTAGSAKSEL	KRAFTUTTAG	TEHONVÄLIOTTOAKSELI
EXT COOL	ΕΞΤΡΑ ΨΥΞΗ	EKSTRA AFKØLING	EXTRA KYLNING	YLIMÄÄRÄINEN JÄÄHDYTIMIN
EXT HEAT	ΕΞΤΡΑ ΘΕΡΜΑΝΣΗ	EKSTRA OPVARMNING	EXTRA VÄRME	YLIMÄÄRÄINEN LÄMMITIN
F	ΓΑΛΛΙΑ	FRANKRIG	FRANKRIKE	RANSKA
FAN	ΑΝΕΜΙΣΤΗΡΑΣ	VENTILATOR	FLÄKT	TUULETIN
FROM	ΑΠΟ	FRA	FRÅN/FR.O.M.	LÄHTIEN/LÄHTÖISIN
GB	ΜΕΓΑΛΗ ΒΡΕΤΑΝΙΑ	STORBRITANNIEN	STORBRITANNIEN	ISO-BRITANNIA
G-PUL	ΗΓΕΤΙΚΟΣ ΡΟΛΟΣ	STYREHJUL	STYRRULLE	JOHTAVA ROOLI
HYD-P	ΥΔΡΑΥΛΙΚΗ ΑΝΤΛΙΑ	HYDRAULIKPUMPE	HYDRAULISK PUMP	HYDRAULIIKKAPUMPPU
IDLER	ΕΝΔΙΑΜΕΣΟΣ ΔΙΣΚΟΣ	MELLEMSKIVE	MELLANLÄGGSBRICKA	VÄLILAATTA
INJ-P	ΑΝΤΛΙΑ ΨΕΚΑΣΜΟΥ	INDSPRØJTNINGSPUMPE	INSPRUTNINGSPUMP	RUISKUTUSPUMPPU
L	ΑΡΙΣΤΕΡΑ	TIL VENSTRE	VÄNSTER	VASEMMALLA
LHD	ΑΡΙΣΤΕΡΟ ΤΙΜΟΝΙ	VENSTRETYRING	VÄNSTERSTYRD	VASEMMANPUOLEINEN OHJAUS
MAN-DR	ΚΙΒΩΤΙΟ ΕΝΑΛΛΑΣΣΟΜΕΝΩΝ ΤΑΧΥΤΗΤΩΝ	GEARKASSE	MANUELL VÄXELLÅDA	KÄSIVAIHTEISTO
MOD	ΜΟΝΤΕΛΛΑ	TYPE	KONSTRUKTIONSTYP	RAKENNEMALLI
MTR-CODE	ΚΩΔΙΚΟΣ ΚΙΝΗΤΗΡΑ	MOTORKODE	MOTORKOD	MOOTTORIN KOODI
MTR-NO.	ΑΡΙΘΜΟΣ ΚΙΝΗΤΗΡΑ	MOTORNUMMER	MOTORNUMMER	MOOTTORIN NUMERO
NL	ΟΛΛΑΝΔΙΑ	NEDERLANDENE/HOLLAND	NEDERLÄNDERNA	ALANKOMAAT
NOT	ΟΧΙ	IKKE	INTE	EI
OE-NO.	ΑΡΙΘΜΟΣ ΠΡΩΤΟΥ ΕΞΟΠΛΙΣΜΟΥ	ORIGINAL-UDSTYRSNUMMER	ORIGINALNUMMER	ENSIASENNUSNUMERO
OIL-P	ΑΝΤΛΙΑ ΛΑΔΙΟΥ	OLIEPUMPE	OLJEPUMP	ÖLJYPUMPPU
Ø-P	ΔΙΣΚΟΙ ΙΜΑΝΤΑ	REMSKIVE-Ø	Ø REMSKIVA	HIHNAPYÖRÄN-Ø
OPT	ΚΑΤΕΠΙΛΟΓΗ	ALTERNATIVT	ALTERNATIVT	VALINNAISESTI
ORGA-NO.	ΑΡΙΘΜΟΣ ΟΡΓΑΝΩΣΗΣ	ORGANISATIONSNUMMER	ORGANISATIONSNUMMER	ORGANISAATIONUMERO
PS	ΣΕΡΒΟΤΙΜΟΝΙ	SERVOSTYRING	SERVOSTYRNING	SERVOTEHOSTEINEN OHJAUS
PTO	ΔΕΥΤΕΡΕΥΟΥΣΑ ΩΘΗΣΗ	HJÆLPEDREV	KRAFTUTTAG	APUKÄYTTÖVOIMA
PUL	ΔΙΣΚΟΣ ΙΜΑΝΤΑ	REMSKIVE	REMSKIVA	HIHNAPYÖRÄ
QTY.	ΠΟΣΟΤΗΤΑ	MÆNGDE	ANTAL	MÄÄRÄ
R	ΔΕΞΙΑ	TIL HØJRE	HÖGER	OIKEALLA
RAD-C	ΣΥΜΠΙΕΣΤΗΣ ΨΥΞΗΣ	KØLEKOMPRESSOR	KYLKOMPRESSOR	JÄÄHDYTYSKOMPRESSORI
REQ	ΧΡΕΙΑΖΕΤΑΙ	NØDVENDIG	KRÄVS	VAADITTU
RHD	ΔΕΞΙ ΤΙΜΟΝΙ	HØJRESTYRING	HÖGERSTYRNING	OIKEANPUOLEINEN OHJAUS
S	ΣΟΥΗΔΙΑ	SVERIGE	SVERIGE	RUOTSI
S-PUL	ΔΙΣΚΟΣ ΣΤΗΡΙΞΗΣ	STØTTESKIVE	STÖDBRICKA	KANNATUSLEVY
STD. COOL	ΣΤΑΝΤΑΡ ΨΥΞΗ	STANDARD AFKØLING	STANDARD KYLNING	VAKIO JÄÄHDYTYS
TENS-PUL	ΤΡΟΧΑΙΑ ΤΑΣΕΩΣ	STRAMRULLE	SPÄNNRULLE	KIRISTYSRULLA
TURBO-C	ΤΟΥΡΜΠΟ ΣΥΜΠΙΕΣΤΗΣ	TURBOKOMPRESSOR	TURBOKOMPRESSOR	TURBOKOMPRESSORI
UNTIL	ΕΩΣ	TIL	TILL	(JONKIN) ASTI
UP	ΑΝΩ	OPPE	ÖVRE	YLHÄÄLLÄ
VAC-P	ΑΝΤΛΙΑ ΚΕΝΟΥ	VAKUUMPUMPE	VAKUUMPUMP	IMUPUMPPU
V-PUL	ΔΙΣΚΟΣ ΟΔΟΝΤΩΝ ΙΜΑΝΤΑ	RIBBEREMSKIVE	RIPPENBANDSKIVA	URAHIHNAPYÖRÄ
W-P	ΑΝΤΛΙΑ ΝΕΡΟΥ	VANDPUMPE	VATTENPUMP	VESIPUMPPU

Inhaber sämtlicher Urheber- und Leistungsschutzrechte sowie sonstiger Nutzungs- und Verwertungsrechte: Arntz OPTIBELT Unternehmensgruppe, Höxter/Deutschland. Jegliche Nutzung, Verwertung, Vervielfältigung oder jegliche Weitergabe an Dritte bedarf der vorherigen schriftlichen Genehmigung durch die Arntz OPTIBELT Unternehmensgruppe, Höxter/Deutschland. Zuwiderhandlungen werden urheberrechtlich verfolgt.

Die Inhalte stellen unverbindliche Angebote dar, die sich ausschließlich an Unternehmen und nicht an Verbraucher richten. OPTIBELT empfiehlt den Einsatz seiner Produkte ausschließlich gemäß den Hinweisen in den OPTIBELT-Dokumentationen. Der Einsatz von OPTIBELT-Produkten in Flugzeugen oder flugzeugähnlichen Systemen, -Produkten und/oder -Applikationen ist nicht zulässig. Im Zweifelsfall ist der Einsatz von OPTIBELT-Produkten vor der Verwendung mit OPTIBELT abzustimmen. OPTIBELT lehnt jegliche Haftung ab, wenn OPTIBELT-Produkte in Systeme, Produkte und/oder Applikationen eingesetzt werden, für welche sie nicht entwickelt und/oder hergestellt wurden. Dies ist insbesondere – aber nicht abschließend – dann der Fall, wenn von einer bestimmten Verwendungseignung oder Beschaffenheitserwartung der OPTIBELT-Produkte außerhalb eines konkreten Vertragsabschlusses mit OPTIBELT ausgegangen wird oder die OPTIBELT-Produkte unter unüblichen oder ein besonderes Gesundheits-, Sicherheits- oder Umwelt-Risiko darstellenden oder eine erhöhte Beanspruchung erfordernden Bedingungen eingesetzt werden.

Irrtümer und Änderungen vorbehalten. OPTIBELT übernimmt keine Gewährleistung, dass die von OPTIBELT zur Verfügung gestellten Informationen vollständig oder richtig sind und von dem Empfänger der Informationen verwendet werden können. OPTIBELT haftet – soweit rechtlich zulässig – daher nicht für Schäden, die durch den Gebrauch oder durch das Vertrauen auf die Vollständigkeit und Richtigkeit der Informationen außerhalb eines konkreten Vertragsabschlusses mit OPTIBELT entstehen.

Es gelten ausschließlich die Allgemeinen Verkaufsbedingungen der OPTIBELT GmbH, Höxter/Deutschland, insbesondere der darin geregelte Eigentumsvorbehalt, auch in seiner verlängerten und erweiterten Form. Diese können kostenlos angefordert werden und sind unter <http://www.optibelt.de/agb/de> abrufbar. Entgegenstehende oder abweichende Geschäftsbedingungen des Kunden verpflichten OPTIBELT nicht, auch wenn OPTIBELT nicht ausdrücklich widerspricht oder ungeachtet entgegenstehender oder abweichender Geschäftsbedingungen des Kunden vorbehaltlos Leistungen erbringt oder Leistungen des Kunden annimmt.

Holder of all copyright and related rights including all rights of use and exploitation: Arntz OPTIBELT Group, Höxter, Germany. No part of this publication may be used, exploited, reproduced or transmitted to third parties in any form without the prior permission of the Arntz OPTIBELT Group, Höxter, Germany. Any infringement will be prosecuted under the copyright act law.

The products on offer provided by OPTIBELT are exclusively oriented towards specialised trade and not towards the consumer. OPTIBELT recommends that its products are to be exclusively used in accordance with the information provided in OPTIBELT documentation. The use of OPTIBELT products in aeroplanes or aviation systems, products and/or applications is not permitted. If in doubt, consult OPTIBELT before using any OPTIBELT products. OPTIBELT does not accept any liability for the use of OPTIBELT products in systems, products and/or applications for which they were not designed and/or manufactured. This is particularly, but not exclusively, the case if OPTIBELT products are to be used outside of any specific agreement with OPTIBELT in circumstances which are unusual or which present a particular risk to health, safety or the environment, or which require a more demanding use.

Errors and omissions excepted. OPTIBELT does not accept any liability for the correctness or completeness of the information supplied by OPTIBELT or for the suitability of the information for use by the recipient of the information. OPTIBELT does not therefore, as far as permitted by law, accept liability for damage resulting outside of any specific agreement with OPTIBELT from the use of the information or the assumption that the information is correct and complete.

The general terms and conditions of sale of OPTIBELT GmbH, Höxter, Germany, in particular the agreements relating to retention of title, including in their longer and extended form, shall apply exclusively. These terms and conditions can be obtained free of charge by visiting <http://www.optibelt.de/agb/de>. OPTIBELT shall not accept any of the customer's own terms and conditions that are contrary to or deviate from these terms and conditions, even if OPTIBELT does not explicitly object to them or unconditionally renders performance or accepts the performance by the customer irrespective of the customer's conflicting or differing terms of business.

**OPTIBELT GmbH**

Corveyer Allee 15  
37671 Hörter  
GERMANY

T +49 (0) 5271-621

F +49 (0) 5271-97 62 00

E [info@optibelt.com](mailto:info@optibelt.com)



[www.optibelt.com](http://www.optibelt.com)